



# WFS3-40P415

WFS

**FORK SENSORS**

**SICK**  
Sensor Intelligence.



Illustration may differ



### Ordering information

Type	Part no.
WFS3-40P415	6043919

Other models and accessories → [www.sick.com/WFS](http://www.sick.com/WFS)

### Detailed technical data

#### Features

<b>Functional principle</b>	Optical detection principle
<b>Dimensions (W x H x D)</b>	10 mm x 25 mm x 64.3 mm
<b>Housing design (light emission)</b>	Fork shaped
<b>Fork width</b>	3 mm
<b>Fork depth</b>	42 mm
<b>Minimum detectable object (MDO)</b>	Gap between Labels / Size of labels: 2 mm <sup>1)</sup>
<b>Label detection</b>	✓
<b>Light source</b>	LED, infrared, Infrared light
<b>Adjustment</b>	Plus/minus button (Teach-in, sensitivity, light/dark switching) Cable (Teach-in dynamic)
<b>Teach-in mode</b>	2-point teach-in Teach-in dynamic

<sup>1)</sup> Depends on the label thickness.

#### Mechanics/electronics

<b>Supply voltage</b>	10 V DC ... 30 V DC <sup>1)</sup>
<b>Ripple</b>	< 10 % <sup>2)</sup>
<b>Current consumption</b>	20 mA <sup>3)</sup>
<b>Switching frequency</b>	10 kHz <sup>4)</sup>
<b>Response time</b>	50 µs <sup>5)</sup>
<b>Stability of response time</b>	± 20 µs
<b>Jitter</b>	40 µs

<sup>1)</sup> Limit values, reverse-polarity protected, operation in short-circuit protected network: max. 8 A.

<sup>2)</sup> May not exceed or fall below  $U_V$  tolerances.

<sup>3)</sup> Without load.

<sup>4)</sup> With light/dark ratio 1:1.

<sup>5)</sup> Signal transit time with resistive load.

<b>Switching output</b>	PNP
<b>Switching output (voltage)</b>	PNP: HIGH = $U_V \leq 2 \text{ V}$ / LOW approx. 0 V
<b>Switching mode</b>	Light/dark switching
<b>Output current <math>I_{\text{max}}</math></b>	100 mA
<b>Input, teach-in (ET)</b>	PNP Teach: $U > 5 \text{ V} \dots < U_V$ Run: $U < 4 \text{ V}$
<b>Initialization time</b>	20 ms
<b>Connection type</b>	Male connector M8, 4-pin
<b>Protection class</b>	III
<b>Circuit protection</b>	$U_V$ connections, reverse polarity protected Output Q short-circuit protected Interference pulse suppression
<b>Enclosure rating</b>	IP65
<b>Weight</b>	Approx. 36 g
<b>Housing material</b>	Plastic, PA (glass-fiber reinforced)

- 1) Limit values, reverse-polarity protected, operation in short-circuit protected network: max. 8 A.
- 2) May not exceed or fall below  $U_V$  tolerances.
- 3) Without load.
- 4) With light/dark ratio 1:1.
- 5) Signal transit time with resistive load.

#### Ambient data

<b>Ambient operating temperature</b>	-20 °C ... +60 °C <sup>1)</sup>
<b>Ambient temperature, storage</b>	-30 °C ... +80 °C
<b>Ambient light immunity</b>	$\leq 10,000 \text{ lx}$
<b>Shock load</b>	According to EN 60068-2-27
<b>UL File No.</b>	NRKH.E191603

- 1) Do not bend below 0 °C.

#### Classifications

<b>ECl@ss 5.0</b>	27270909
<b>ECl@ss 5.1.4</b>	27270909
<b>ECl@ss 6.0</b>	27270909
<b>ECl@ss 6.2</b>	27270909
<b>ECl@ss 7.0</b>	27270909
<b>ECl@ss 8.0</b>	27270909
<b>ECl@ss 8.1</b>	27270909
<b>ECl@ss 9.0</b>	27270909
<b>ECl@ss 10.0</b>	27270909
<b>ECl@ss 11.0</b>	27270909
<b>ETIM 5.0</b>	EC002720
<b>ETIM 6.0</b>	EC002720
<b>ETIM 7.0</b>	EC002720
<b>ETIM 8.0</b>	EC002720

UNSPSC 16.0901

39121528

### Dimensional drawing (Dimensions in mm (inch))

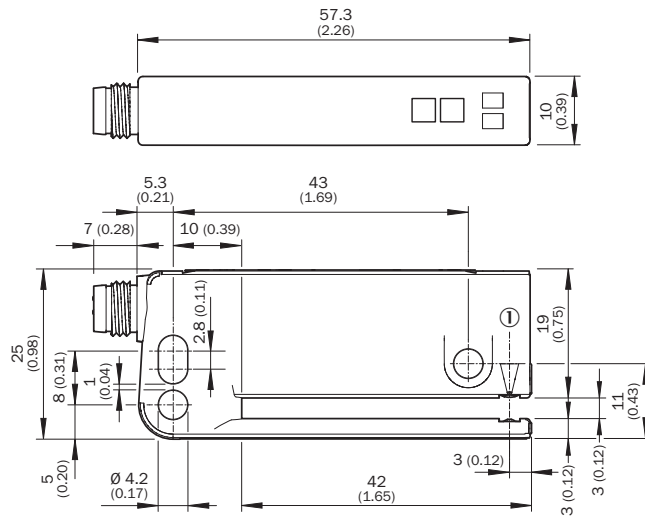

① Optical axis

### Adjustments

Adjustment: teach-in via plus/minus buttons (WFxx-B416)

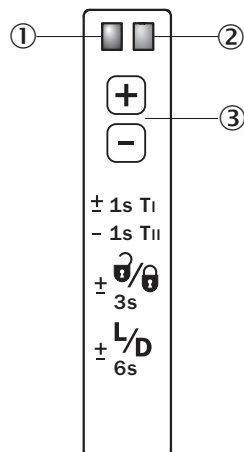

- ① Function signal indicator (yellow), switching output
- ② Function indicator (red)
- ③ “+”/“-” buttons and function button

## Connection diagram

Cd-092

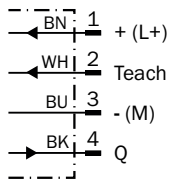

## Concept of operation

**1. Position label or substrate in the active area of the fork sensor**

**2. Move multiple labels through the fork sensor**

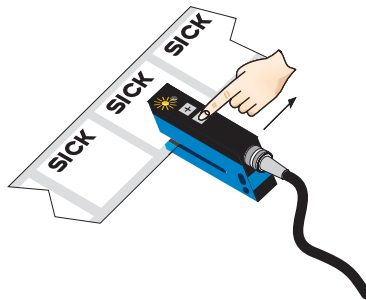
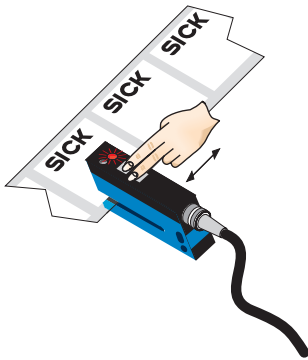

Press both the “+” and “-” buttons together, hold > 1 s and then release the teach-in buttons. The red LED flashes.

Press “-” button, teach-in process is finished.

### Notes

Switching threshold adaptation:

Only, the first teach-in procedure after switching on is permanently stored. Teach-in can be repeated cyclically. Switching output also during teach-in active.

- + Once teach-in process is complete, the switching threshold can be adjusted at any time using the “+” or “-” button. To make minor adjustments, press the “+” or “-” button once. To configure settings quickly, keep the “+” or “-” button pressed for longer.





$\pm \frac{3}{3s}$  Press both the “+” and “-” buttons together (3 seconds) to lock the device and prevent unintentional actuation.

$\pm \frac{L/D}{6s}$  Press both the “+” and “-” buttons together (6 seconds) to define the switching function (light/dark switching). Standard setting: Q = light switching.

Teach-in (static): Setting the switching threshold without movements of label, cf. operating instruction.

### Recommended accessories

Other models and accessories → [www.sick.com/WFS](http://www.sick.com/WFS)

	Brief description	Type	Part no.
<b>Universal bar clamp systems</b>			
	WFS mounting rod, straight, including 2 x fixing screws, Aluminum	BEF-M12GF-A	2059414
	Bar clamp for bar diameter of 12 mm (fixing the mounting rod), Aluminum, 2 screws M6 x 30, 2 spring discs	BEF-RMC-D12	5321878
<b>Plug connectors and cables</b>			
	Head A: female connector, M8, 4-pin, straight, A-coded Head B: Flying leads Cable: Sensor/actuator cable, PVC, unshielded, 5 m	YF8U14-050VA3XLEAX	2095889
	Head A: male connector, M8, 4-pin, straight Head B: - Cable: unshielded	STE-0804-G	6037323

## SICK AT A GLANCE

SICK is one of the leading manufacturers of intelligent sensors and sensor solutions for industrial applications. A unique range of products and services creates the perfect basis for controlling processes securely and efficiently, protecting individuals from accidents and preventing damage to the environment.

We have extensive experience in a wide range of industries and understand their processes and requirements. With intelligent sensors, we can deliver exactly what our customers need. In application centers in Europe, Asia and North America, system solutions are tested and optimized in accordance with customer specifications. All this makes us a reliable supplier and development partner.

Comprehensive services complete our offering: SICK LifeTime Services provide support throughout the machine life cycle and ensure safety and productivity.

For us, that is “Sensor Intelligence.”

## WORLDWIDE PRESENCE:

Contacts and other locations –[www.sick.com](http://www.sick.com)