



Online Data Sheet

Encoder WDGI 58H

www.wachendorff-automation.com/wdgi58h

Wachendorff Automation

... systems and encoders

- Complete systems
- Industrial rugged encoders to suit your application
- Standard range and customer versions
- Maximum permissible loads
- 48-hour express production
- Made in Germany
- Worldwide distributor network

Encoder WDGI 58H



- Rugged industrial standard encoder
- Housing cap die cast aluminum, with particularly eco-friendly powder coating
- Up to 25000 PPR by use of high grad electronics
- Thru-Bore
- High protection class IP65, with oil seal
- Maximum mechanical and electrical safety
- High noise immunity
- Full connection protection with 10 VDC up to 30 VDC
- High output frequency 600 kHz/2 MHz
- Optional: -40 °C up to +85 °C, Pressure equalising membrane

www.wachendorff-automation.com/wdgi58h

Resolution

Max. pulses per revolution PPR	2048 ppr
--------------------------------	----------

Mechanical Data

Housing

Flange	hollow shaft (through-bored)
Flange material	aluminum
Housing cap	die cast aluminum, powder coated
Torque supports	incl. 1 torque support WDGDS10001
- 1. Spring plate compensation	axial: ±0.8 mm, radial: ±0.2 mm
- Max. operating speed	6000 rpm up to max. protection rating +60 °C
- 2. Cylinder pin 4 mm	needs accessories WDGDS10005
- Compensation	axial: ±0.5 mm, radial: ±1.5 mm, Max. operating speed: 3000 rpm
Housing	Ø 58 mm

Shaft(s)

Shaft material	stainless steel
Starting torque	approx. 2.2 Ncm at ambient temperature
Fixing	permanently attached clamping ring
Shaft	Ø 12 mm
Shaft length	L: 44.5 mm
Max. Permissible shaft loading radial	80 N
Max. Permissible shaft loading axial	60 N

Bearings

Bearings type	2 precision ball bearings
Nominal service life	1 x 10 ⁹ revs. at 100 % rated shaft load 1 x 10 ¹⁰ revs. at 40 % rated shaft load 1 x 10 ¹¹ revs. at 20 % rated shaft load
Max. operating speed	6000 rpm

Machinery Directive: basic data safety integrity level

MTTF _d	200 a
Mission time (TM)	25 a
Nominal service life (L10h)	1 x 10 ¹¹ revs. at 20 % rated shaft load and 6000 rpm
Diagnostic coverage (DC)	0 %

Electrical Data

Power supply VDC	5 - 30 VDC
Current consumption	typ. 70 mA
Signal shape	square-wave
Output circuit	HTL inverted
Channels	AB, ABN, and inverted signals
Output	push-pull
Load	max. 40 mA / channel
Signal level mA	at 20 mA
Signal level H>	H > V _{cc} - 10 % V _{cc}
Signal level L<	L < 2.5 VDC
Output frequency	max. 200 kHz
Circuit protection	inverse-polarity protection only
Light reserve warning	no

General Data

Weight	approx. 220 g
Connections	cable or connector, radial
Protection rating (EN 60529)	IP65 all around
Operating temperature	Connector: -40 °C up to +85 °C, cable: -20 °C up to +80 °C, (Option ACA: -40 °C up to +85 °C) 1 Vpp: -10 °C up to +70 °C
Storage temperature	Connector: -30 °C up to +85 °C, cable: -30 °C up to +80 °C, option ACA: -40 °C up to +85 °C

More Information

General technical data and safety instructions
<http://www.wachendorff-automation.com/gtd>

Options
<http://www.wachendorff-automation.com/acc>

WDGI 58H: Cable connection K3, L3, radial, with 2 m cable

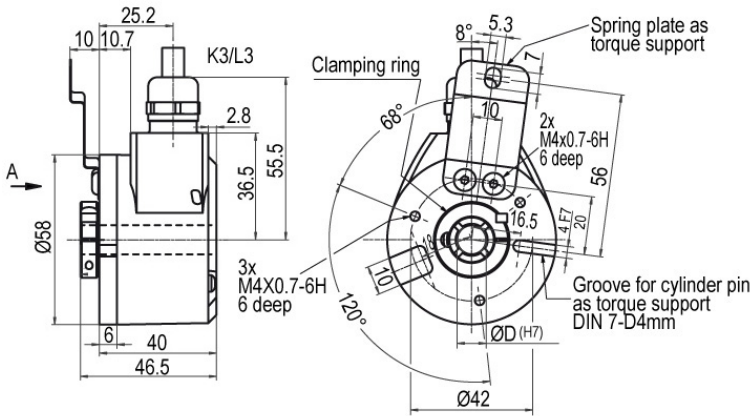

Description

ABN inv. poss.

K3 radial, shield not connected

•

Assignments	
	K3
Circuit	R30
GND	WH
(+) Vcc	BN
A	GN
B	YE
N	GY
Light reserve warning	-
A inv.	RD
B inv.	BK, (BU at ACA)
N inv.	VT
Shield	flex

Options

Pressure equalising membrane

The WDGI 58H shaft encoder is also optionally available with a pressure equalising membrane. This prevents water from penetrating into the encoder housing in the case of high air humidity.
The IP67 protection level, temperature range and salt spray resistance are maintained.
Resistant to chemicals and solvents in accordance with DIN EN ISO 2812-1.

Order key

ACR

Cable length

The encoder WDGI 58H can be supplied with more than 2 m cable. The maximum cable length depends on the supply voltage and the frequency; see www.wachendorff-automation.com/atd
Please extend the standard order code with a three figure number, specifying the cable length in decimetres.
Example: 5 m cable = 050

Order key

XXX = Decimeter

Example Order No.	Type					Your encoder
WDGI 58H	WDGI 58H					WDGI 58H
	Bore size					
12	12					12
	Pulses per revolution PPR:					
2048	2048					2048
	Channels:					
ABN	ABN					ABN
	Output circuit					
R30	Resolution PPR	Power supply VDC	Output circuit	Light reserve warning	Order key	R30
	up to 2500	5 - 30	HTL inverted	-	R30	
	Electrical connections					
K3	Description			ABN inv. poss.	Order key	K3
	Cable: length (2 m standard, WDG 58T: 1 m) radial, shield not connected			•	K3	
	Options					
	Description			Order key		
	Pressure equalising membrane			ACR		
	Cable length			Cable length		
	Without option			Empty		

Example Order No.=	WDGI 58H	12	2048	ABN	R30	K3		WDGI 58H	12	2048	ABN	R30	K3		Your encoder
---------------------------	----------	----	------	-----	-----	----	--	----------	----	------	-----	-----	----	--	---------------------



For further information please contact our local distributor.
Here you find a list of our distributors worldwide.
<https://www.wachendorff-automation.com/>



Wachendorff Automation GmbH & Co. KG
Industriestrasse 7 • 65366 Geisenheim
Germany

Phone: +49 67 22 / 99 65 25
Fax: +49 67 22 / 99 65 70
E-Mail: wdg@wachendorff.de
www.wachendorff-automation.de

