



Online Data Sheet

Encoder WdGI 58B

www.wachendorff-automation.com/wdgi58b

Wachendorff Automation

... systems and encoders

- Complete systems
- Industrial rugged encoders to suit your application
- Standard range and customer versions
- Maximum permissible loads
- 48-hour express production
- Made in Germany
- Worldwide distributor network

Encoder WDGI 58B



- Rugged industrial standard encoder
- Housing cap die cast aluminum, with particularly eco-friendly powder coating
- Up to 25000 PPR by use of high grad electronics
- Protection to IP67, shaft sealed to IP65
- Maximum mechanical and electrical safety
- Full connection protection with 10 VDC up to 30 VDC
- High output frequency 600 kHz/2 MHz
- Optional:
 - 40 °C up to +85 °C,
 - Protection to IP67 all around,
 - Pressure equalising membrane

www.wachendorff-automation.com/wdgi58b

Resolution

Max. pulses per revolution PPR	360 ppr
--------------------------------	---------

Mechanical Data

Housing

Flange	clamping flange
Flange material	aluminum
Housing cap	die cast aluminum, powder coated
Housing	Ø 58 mm
Cam mounting	pitch 69 mm

Shaft(s)

Shaft material	stainless steel
Starting torque	approx. 1 Ncm at ambient temperature
Shaft	Ø 10 mm
Shaft length	L: 20 mm
Max. Permissible shaft loading radial	220 N
Max. Permissible shaft loading axial	120 N

Bearings

Bearings type	2 precision ball bearings
Nominale service life	1 x 10 ⁹ revs. at 100 % rated shaft load 1 x 10 ¹⁰ revs. at 40 % rated shaft load 1 x 10 ¹¹ revs. at 20 % rated shaft load
Max. operating speed	8000 rpm

Machinery Directive: basic data safety integrity level

MTTF _d	200 a
Mission time (TM)	25 a
Nominale service life (L10h)	1 x 10 ¹¹ revs. at 20 % rated shaft load and 8000 rpm
Diagnostic coverage (DC)	0 %

Electrical Data

Power supply VDC	5 - 30 VDC
Current consumption	typ. 70 mA
Signal shape	square-wave
Output circuit	HTL inverted
Channels	AB, ABN, and inverted signals
Output	push-pull
Load	max. 40 mA / channel
Signal level mA	at 20 mA

Signal level H>	H > V _{cc} - 10 % V _{cc}
Signal level L<	L < 2.5 VDC
Output frequency	max. 200 kHz
Circuit protection	inverse-polarity protection only
Light reserve warning	no

General Data

Weight	approx. 250 g
Connections	cable or connector outlet
Protection rating (EN 60529)	Housing: IP65, IP67; shaft sealed: IP65
Operating temperature	Connector: -40 °C up to +85 °C, cable: -20 °C up to +80 °C, (Option ACA: -40 °C up to +85 °C) 1 Vpp: -10 °C up to +70 °C
Storage temperature	Connector: -30 °C up to +85 °C, cable: -30 °C up to +80 °C, option ACA: -40 °C up to +85 °C

More Information

General technical data and safety instructions
<http://www.wachendorff-automation.com/gtd>

Options
<http://www.wachendorff-automation.com/acc>

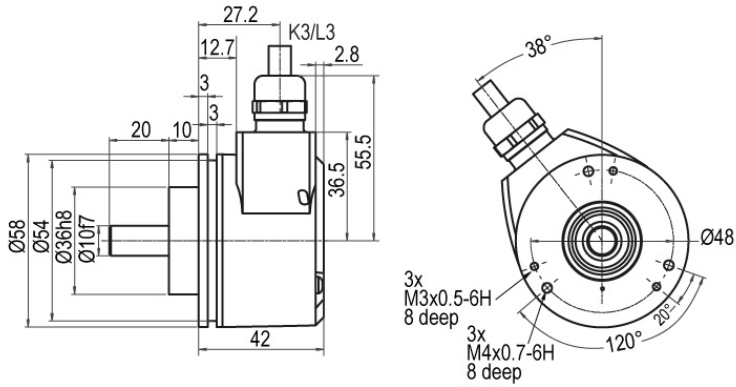
WDGI 58B: Cable connection K3, L3, radial, with 2 m cable

Description
ABN inv. poss.
K3 radial, shield not connected

•

Assignments	
	K3
Circuit	R30
GND	WH
(+) Vcc	BN
A	GN
B	YE
N	GY
Light reserve warning	-
A inv.	RD
B inv.	BK, (BU at ACA)
N inv.	VT
Shield	flex

Options

Low-friction bearings

The encoder WDG1 58B is also available as a particularly smooth-running low-friction encoder. The starting torque is thereby changed to 0.5 Ncm and the protection class at the shaft input to IP50.

Order key

AAC

Shaft with flat

The encoder WDG1 58B can be supplied with a shaft with flat.

Order key

AAF

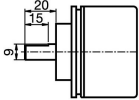

IP67 Shafts sealed to IP67 (not for 1 Vpp Sin/Cos)

The encoder WDG1 58B can be supplied in a full IP67 version.

Order key

AAO

Max. RPM: 3500 rpm

Permitted Shaft-Loading, axial: 100 N

Permitted Shaft-Loading, radial: 110 N

Max. PPR: 2500 ppr

Starting-torque: approx. 4 Ncm at ambient temperature

Pressure equalising membrane

The WDG1 58B shaft encoder is also optionally available with a pressure equalising membrane. This prevents water from penetrating into the encoder housing in the case of high air humidity.

The IP67 protection level, temperature range and salt spray resistance are maintained.

Resistant to chemicals and solvents in accordance with DIN EN ISO 2812-1.

Order key

ACR

Cable length

The encoder WDG1 58B can be supplied with more than 2 m cable. The maximum cable length depends on the supply voltage and the frequency; see www.wachendorff-automation.com/atd

Please extend the standard order code with a three figure number, specifying the cable length in decimetres.

Example: 5 m cable = 050

Order key

XXX = Decimeter

Example Order No.	Type					Your encoder
WDGI 58B	WDGI 58B					WDGI 58B
	Shaft					
10	10					10
	Pulses per revolution PPR:					
360	360					360
	Channels:					
ABN	ABN					ABN
	Output circuit					
R30	Resolution PPR	Power supply VDC	Output circuit	Light reserve warning	Order key	R30
	up to 2500	5 - 30	HTL inverted	-	R30	
	Electrical connections					
K3	Description			ABN inv. poss.	Order key	K3
	Cable: length (2 m standard, WDG 58T: 1 m) radial, shield not connected			•	K3	
	Options					
	Description			Order key		
	Low-friction bearings			AAC		
	Shaft with flat			AAF		
	IP67			AAO		
	Pressure equalising membrane			ACR		
	Cable length			Cable length		
	Without option			Empty		

Example Order No.=	WDGI 58B	10	360	ABN	R30	K3		WDGI 58B	10	360	ABN	R30	K3		Your encoder
---------------------------	----------	----	-----	-----	-----	----	--	----------	----	-----	-----	-----	----	--	---------------------



For further information please contact our local distributor.
Here you find a list of our distributors worldwide.
<https://www.wachendorff-automation.com/>



Wachendorff Automation GmbH & Co. KG
Industriestrasse 7 • 65366 Geisenheim
Germany

Phone: +49 67 22 / 99 65 25
Fax: +49 67 22 / 99 65 70
E-Mail: wdg@wachendorff.de
www.wachendorff-automation.de

