



Silicon NPN Phototransistor



VENT2003X01



VENT2023X01

DESCRIPTION

VENT2003X01 series are silicon NPN epitaxial planar phototransistors with daylight blocking filter in a miniature, black dome lens package for surface mounting. Filter bandwidth is matched with 830 nm to 950 nm IR emitters.

FEATURES

- Package type: surface mount
- Package form: GW, RGW
- Dimensions (L x W x H in mm): 2.3 x 2.3 x 2.55
- AEC-Q101 qualified
- High radiant sensitivity
- Daylight blocking filter matched with 830 nm to 950 nm IR emitters
- Fast response times
- Angle of half sensitivity: $\phi = \pm 35^\circ$
- Package matched with IR emitter series VSMB2943RGX01 and VSMB2943GX01
- Floor life: 4 weeks, MSL 2a, acc. J-STD-020
- Lead (Pb)-free reflow soldering
- Material categorization: For definitions of compliance please see www.vishay.com/doc?99912



APPLICATIONS

- Detector in automotive applications
- Photo interrupters
- Miniature switches
- Counters
- Encoders
- Position sensors

PRODUCT SUMMARY			
COMPONENT	I _{ca} (mA)	ϕ (deg)	$\lambda_{0.5}$ (nm)
VENT2003X01	2.7	± 35	790 to 970
VENT2023X01	2.7	± 35	790 to 970

Note

- Test condition see table "Basic Characteristics"

ORDERING INFORMATION			
ORDERING CODE	PACKAGING	REMARKS	PACKAGE FORM
VENT2003X01	Tape and reel	MOQ: 6000 pcs, 6000 pcs/reel	Reverse gullwing
VENT2023X01	Tape and reel	MOQ: 6000 pcs, 6000 pcs/reel	Gullwing

Note

- MOQ: minimum order quantity



ABSOLUTE MAXIMUM RATINGS ($T_{amb} = 25\text{ }^{\circ}\text{C}$, unless otherwise specified)				
PARAMETER	TEST CONDITION	SYMBOL	VALUE	UNIT
Collector emitter voltage		V_{CEO}	20	V
Emitter collector voltage		V_{ECO}	7	V
Collector current		I_C	50	mA
Power power dissipation	$T_{amb} \leq 75\text{ }^{\circ}\text{C}$	P_V	100	mW
Junction temperature		T_j	100	$^{\circ}\text{C}$
Operating temperature range		T_{amb}	- 40 to + 100	$^{\circ}\text{C}$
Storage temperature range		T_{stg}	- 40 to + 100	$^{\circ}\text{C}$
Soldering temperature	Acc. reflow profile fig. 8	T_{sd}	260	$^{\circ}\text{C}$
Thermal resistance junction/ambient	Acc. J-STD-051	R_{thJA}	250	K/W



Fig. 1 - Power Dissipation Limit vs. Ambient Temperature

BASIC CHARACTERISTICS ($T_{amb} = 25\text{ }^{\circ}\text{C}$, unless otherwise specified)						
PARAMETER	TEST CONDITION	SYMBOL	MIN.	TYP.	MAX.	UNIT
Collector emitter breakdown voltage	$I_C = 0.1\text{ mA}$	V_{CEO}	20			V
Collector dark current	$V_{CE} = 5\text{ V}, E = 0$	I_{CEO}		1	100	nA
Collector emitter capacitance	$V_{CE} = 0\text{ V}, f = 1\text{ MHz}, E = 0$	C_{CEO}		25		pF
Collector light current	$E_e = 1\text{ mW/cm}^2, \lambda = 950\text{ nm}, V_{CE} = 5\text{ V}$	I_{ca}	1.3	2.7	4.1	mA
Angle of half sensitivity		ϕ		± 35		deg
Wavelength of peak sensitivity		λ_p		860		nm
Range of spectral bandwidth		$\lambda_{0.5}$		790 to 970		nm
Collector emitter saturation voltage	$I_C = 0.05\text{ mA}$	V_{CEsat}			0.4	V
Temperature coefficient of I_{ca}	$E_e = 1\text{ mW/cm}^2, \lambda = 950\text{ nm}, V_{CE} = 5\text{ V}$	Tk_{Ica}		1.1		%/K

BASIC CHARACTERISTICS ($T_{amb} = 25\text{ }^{\circ}\text{C}$, unless otherwise specified)



Fig. 2 - Collector Dark Current vs. Ambient Temperature



Fig. 5 - Relative Spectral Sensitivity vs. Wavelength

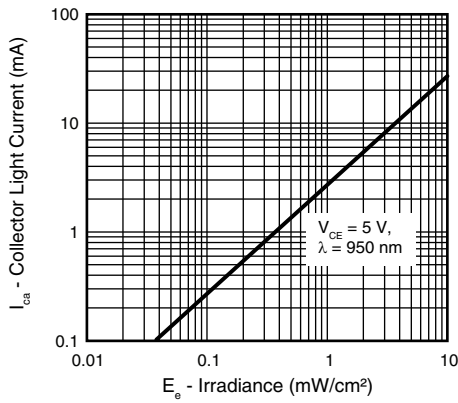

Fig. 3 - Collector Light Current vs. Irradiance

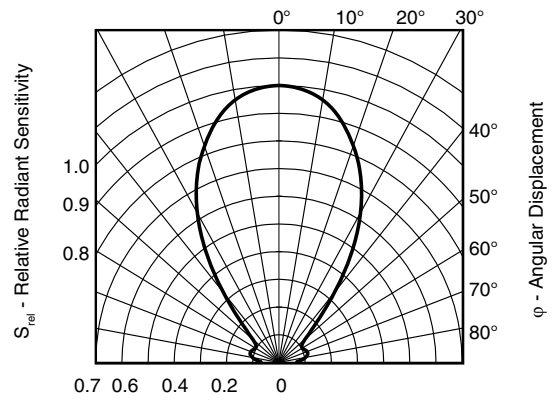

Fig. 6 - Relative Radiant Sensitivity vs. Angular Displacement



Fig. 4 - Rise/Fall Time vs. Collector Current



Fig. 7 - Relative Collector Current vs. Ambient Temperature

REFLOW SOLDER PROFILE

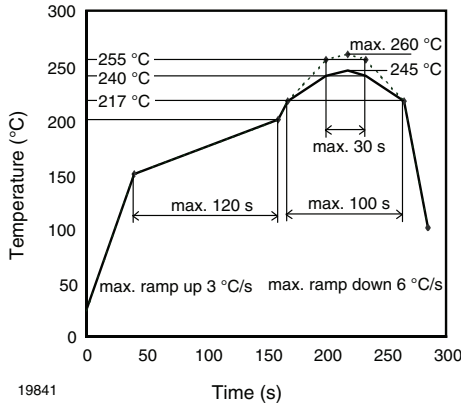

Fig. 8 - Lead (Pb)-free Reflow Solder Profile acc. J-STD-020

DRYPACK

Devices are packed in moisture barrier bags (MBB) to prevent the products from moisture absorption during transportation and storage. Each bag contains a desiccant.

FLOOR LIFE

Floor life (time between soldering and removing from MBB) must not exceed the time indicated on MBB label:

Floor life: 4 weeks

Conditions: $T_{amb} < 30\text{ }^{\circ}\text{C}$, RH < 60 %

Moisture sensitivity level 2a, acc. to J-STD-020.

DRYING

In case of moisture absorption devices should be baked before soldering. Conditions see J-STD-020 or label. Devices taped on reel dry using recommended conditions 192 h at 40 °C (+ 5 °C), RH < 5 %.

PACKAGE DIMENSIONS VEMT2003X01 in millimeters

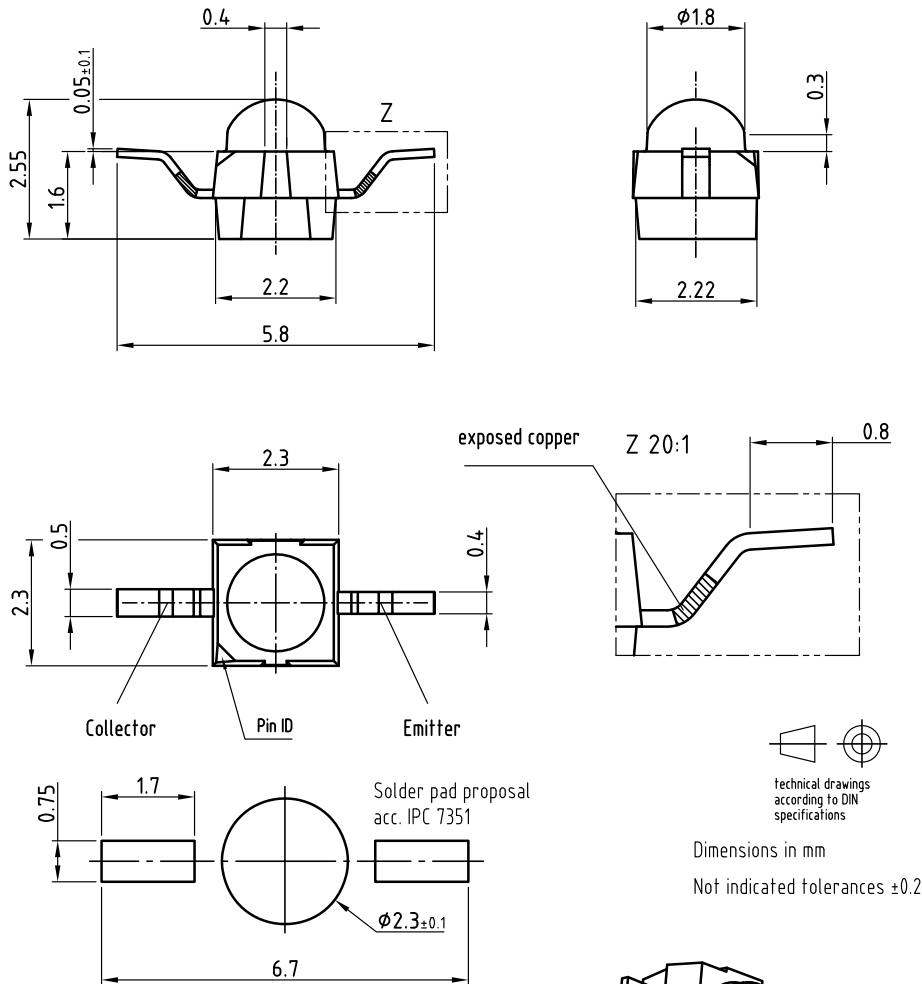

Dimensions in mm
Not indicated tolerances ±0.2

Drawing refers to following types: VEMT2x03X01

Drawing-No.: 6.544-5409.02-4
Issue: prel. 03.08.12

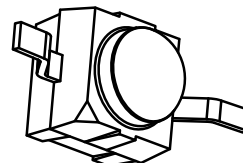



PACKAGE DIMENSIONS VEMT2023X01 in millimeters

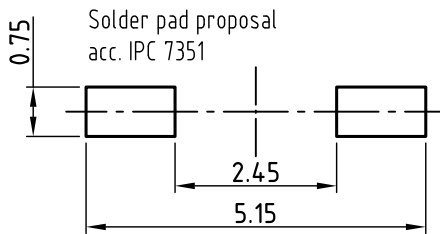
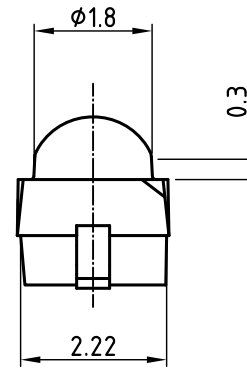

technical drawings according to DIN specifications

Dimensions in mm

Not indicated tolerances ±0.2

Drawing refers to following types: VEMT2x23X01

Drawing-No.: 6.544-5408.02-4
Issue: prel; 03.08.12

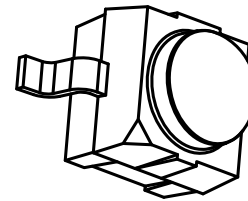

TAPE AND REEL DIMENSIONS VEMT2003X01 in millimeters

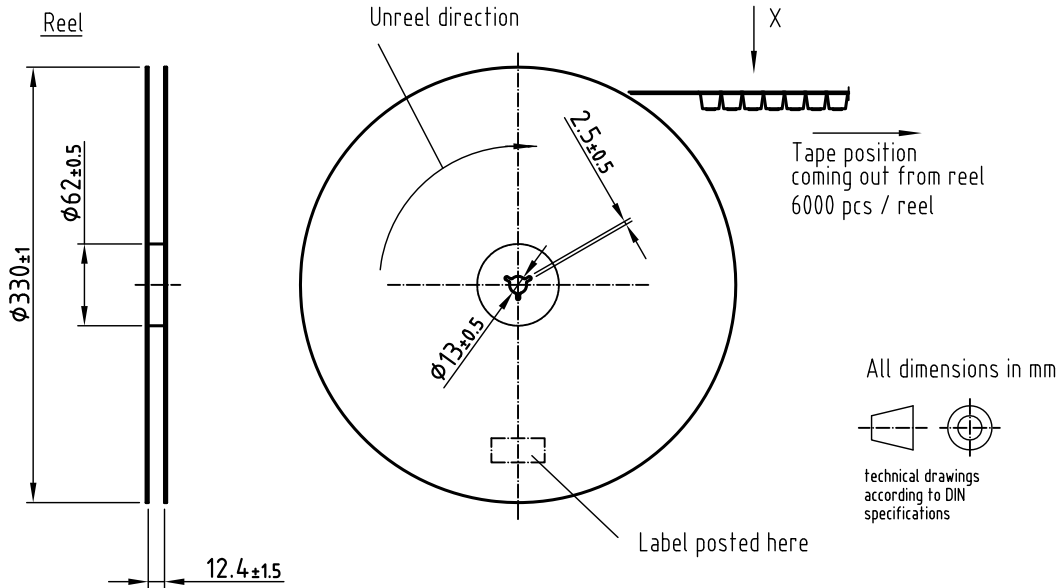

Leader and trailer tape:

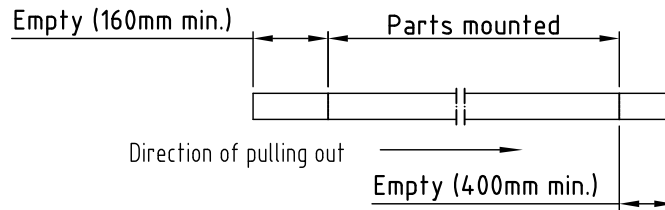

Terminal position in tape

Device	Lead I	Lead II
V SMB2943RGX01	Cathode	Anode
V SMF2893RGX01		
V EMD2x03X01		
VEMT2x03X01	Collector	Emitter
VSMY2853RG	Anode	Cathode

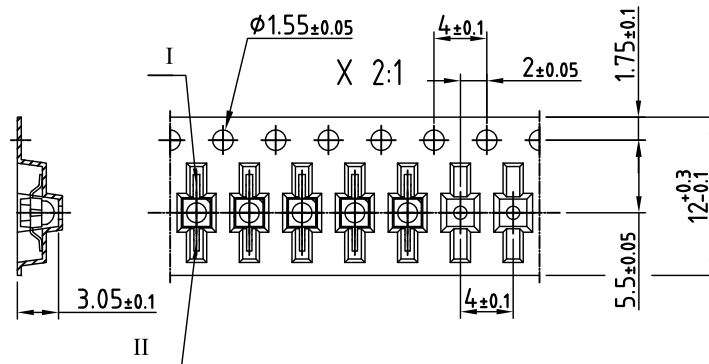

Drawing refers to following types: see table
Reel dimensions and tape

Drawing-No.: 9.800-5100.02-4
Issue: prel; 03.08.12

TAPE AND REEL DIMENSIONS VENT2023X01 in millimeters

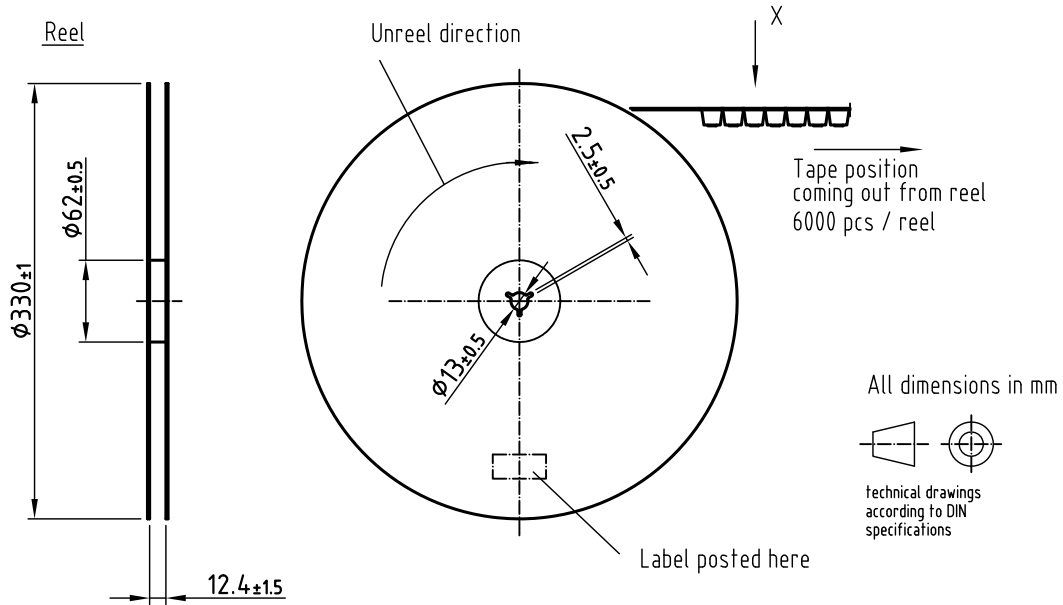

Leader and trailer tape:

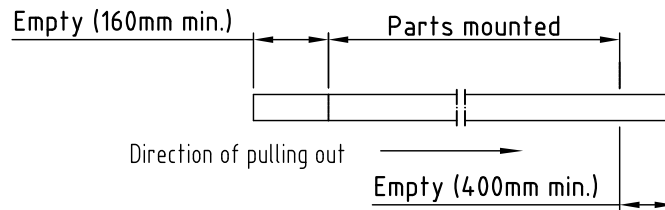

Terminal position in tape

Device	Lead I	Lead II
VSMB2943GX01	Cathode	Anode
VSMF2893GX01		
VEMD2x23X01		
VENT2x23X01	Collector	Emitter
VSMY2853G	Anode	Cathode

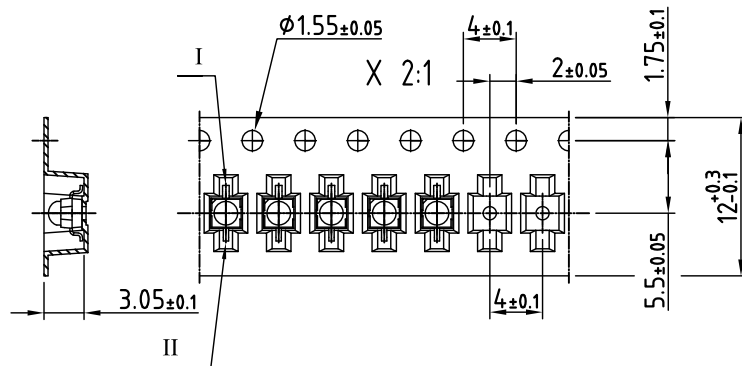

Drawing refers to following types: see table
Reel dimensions and tape

Drawing-No.: 9.800-5091.21-4
Issue: prel; 03.08.12



Disclaimer

ALL PRODUCT, PRODUCT SPECIFICATIONS AND DATA ARE SUBJECT TO CHANGE WITHOUT NOTICE TO IMPROVE RELIABILITY, FUNCTION OR DESIGN OR OTHERWISE.

Vishay Intertechnology, Inc., its affiliates, agents, and employees, and all persons acting on its or their behalf (collectively, "Vishay"), disclaim any and all liability for any errors, inaccuracies or incompleteness contained in any datasheet or in any other disclosure relating to any product.

Vishay makes no warranty, representation or guarantee regarding the suitability of the products for any particular purpose or the continuing production of any product. To the maximum extent permitted by applicable law, Vishay disclaims (i) any and all liability arising out of the application or use of any product, (ii) any and all liability, including without limitation special, consequential or incidental damages, and (iii) any and all implied warranties, including warranties of fitness for particular purpose, non-infringement and merchantability.

Statements regarding the suitability of products for certain types of applications are based on Vishay's knowledge of typical requirements that are often placed on Vishay products in generic applications. Such statements are not binding statements about the suitability of products for a particular application. It is the customer's responsibility to validate that a particular product with the properties described in the product specification is suitable for use in a particular application. Parameters provided in datasheets and / or specifications may vary in different applications and performance may vary over time. All operating parameters, including typical parameters, must be validated for each customer application by the customer's technical experts. Product specifications do not expand or otherwise modify Vishay's terms and conditions of purchase, including but not limited to the warranty expressed therein.

Except as expressly indicated in writing, Vishay products are not designed for use in medical, life-saving, or life-sustaining applications or for any other application in which the failure of the Vishay product could result in personal injury or death. Customers using or selling Vishay products not expressly indicated for use in such applications do so at their own risk. Please contact authorized Vishay personnel to obtain written terms and conditions regarding products designed for such applications.

No license, express or implied, by estoppel or otherwise, to any intellectual property rights is granted by this document or by any conduct of Vishay. Product names and markings noted herein may be trademarks of their respective owners.