

## Table of Contents

| Title                                    | Page |
|--|------|
| <b>Overview</b> .....                    | 3    |
| Unpacking Inspection .....               | 4    |
| Safety Information .....                 | 5    |
| Rules For Safe Operation .....           | 6    |
| International Electrical Symbols .....   | 8    |
| The Meter Structure .....                | 9    |
| Rotary Switch .....                      | 10   |
| Functional Buttons .....                 | 11   |
| Display Symbols .....                    | 12   |
| Measurement Operation .....              | 14   |
| A. DC and AC Voltage Measurement .....   | 14   |
| B. DC and AC Current Measurement .....   | 15   |
| C. Measuring Resistance .....            | 17   |
| D. Measuring Diodes and Continuity ..... | 18   |
| E. Frequency Measurement .....           | 20   |
| F. Temperature Measurement .....         | 21   |
| G. Capacitance Measurement .....         | 23   |
| H. Measuring Transistor .....            | 25   |
| Sleep Mode .....                         | 26   |
| Operation of Hold Mode .....             | 26   |
| General Specifications .....             | 27   |
| Accuracy Specifications .....            | 28   |
| A. DC Voltage .....                      | 28   |
| B. AC Voltage .....                      | 28   |
| C. DC Current .....                      | 28   |
| D. AC Current .....                      | 29   |
| E. Resistance Test .....                 | 29   |
| F. Diodes and Continuity Test .....      | 30   |
| G. Frequency .....                       | 30   |
| H. Temperature .....                     | 31   |
| I. Capacitance .....                     | 31   |
| J. Transistor test .....                 | 31   |



**Model UT58E: OPERATING MANUAL**

| <b>Title</b>                   | <b>Page</b> |
|--------------------------------|-------------|
| Maintenance -----              | 32          |
| A. General Services -----      | 32          |
| B. Replacing the Fuses -----   | 32          |
| C. Replacing the Battery ----- | 33          |

### Overview



**To avoid electric shock or personal injury, read the “Safety Information” and “Rules for Safety Operation” carefully before using the Meter.**

Digital Multimeters Model UT58E (hereafter referred to as “the Meter”) is 4 1/2 digits with ex-large LCD, steady operations, fashionable structure and highly reliable hand-held measuring instrument. The Meter uses large scale of integrated circuit with double integrated A/D converter as its core and has full range overload protection. The Meter has 28 different measuring functions. It has not only can measure AC/DC Voltage, AC/DC Current, Resistance, Temperature, Capacitance, Frequency, Transistor, Diode and Continuity, but also have Data Hold, Full Icon Display, Overload Protection and Sleep Mode features.

### Unpacking Inspection

Open the package case and take out the Meter. Check the following items carefully to see any missing or damaged part:

| Item | Description                          | Qty     |
|------|--------------------------------------|---------|
| 1    | English Operating Manual             | 1 piece |
| 2    | Test Lead                            | 1 pair  |
| 3    | Multi-Purpose Socket                 | 1 piece |
| 4    | Test Clip                            | 1 piece |
| 5    | Point Contact Temperature Probe      | 1 piece |
| 6    | Holster                              | 1 piece |
| 7    | 9V Battery (NEDA 1604, 6F22 or 009P) | 1 piece |

In the event you find any missing or damage, please contact your dealer immediately.

### Safety Information

This Meter complies with the standards IEC61010: in pollution degree 2, overvoltage category (CAT. II 1000V, CAT. III 600V) and double insulation.

CAT. II: Local level, appliance, PORTABLE EQUIPMENT etc., with smaller transient voltage overvoltages than CAT. III

CAT. III: Distribution level, fixed installation, with smaller transient overvoltages than CAT. IV

Use the Meter only as specified in this operating manual, otherwise the protection provided by the Meter may be impaired.

In this manual, a **Warning** identifies conditions and actions that pose hazards to the user, or may damage the Meter or the equipment under test.

A **Note** identifies the information that user should pay attention to.

International electrical symbols used on the Meter and in this Operating Manual are explained on page 8

## Rules For Safe Operation (1)

### Warning











To avoid possible electric shock or personal injury, and to avoid possible damage to the Meter or to the equipment under test, adhere to the following rules:

- 1 Before using the Meter inspect the case. Do not use the Meter if it is damaged or the case (or part of the case) is removed. Look for cracks or missing plastic. Pay attention to the insulation around the connectors.
- 1 Inspect the test leads for damaged insulation or exposed metal. Check the test leads for continuity. Replace damaged test leads with identical model number or electrical specifications before using the Meter.
- 1 Do not apply more than the rated voltage, as marked on the Meter, between the terminals or between any terminal and grounding.
- 1 The rotary switch should be placed in the right position and no any changeover of range shall be made during measurement is conducted to prevent damage of the Meter.
- 1 When the Meter working at an effective voltage over 60V in DC or 30V rms in AC, special care should be taken for there is danger of electric shock.
- 1 Use the proper terminals, function, and range for your measurements.
- 1 If the value to be measured is unknown, use the maximum measurement position and reduce the range stop by step until a satisfactory reading is obtained.
- 1 Do not use or store the Meter in an environment of high temperature, humidity, explosive, inflammable and strong magnetic field. The performance of the Meter may deteriorate after dampened.

## Rules For Safe Operation (2)

- 1 When using the test leads, keep your fingers behind the finger guards.
- 1 Disconnect circuit power and discharge all high-voltage capacitors before testing resistance, continuity, diodes, capacitance or current.
- 1 Before measuring current, check the Meter's fuses and turn off power to the circuit before connecting the Meter to the circuit.
- 1 Replace the battery as soon as the battery indicator  appears. With a low battery, the Meter might produce false readings that can lead to electric shock and personal injury.
- 1 Remove test leads and multi-purpose socket from the Meter and turn the Meter power off before opening the Meter case.
- 1 When servicing the Meter, use only the same model number or identical electrical specifications replacement parts.
- 1 The internal circuit of the Meter shall not be altered at will to avoid damage of the Meter and any accident.
- 1 Soft cloth and mild detergent should be used to clean the surface of the Meter when servicing. No abrasive and solvent should be used to prevent the surface of the Meter from corrosion, damage and accident.
- 1 The Meter is suitable for indoor use.
- 1 Turn the Meter power off when it is not in use and take out the battery when not using for a long time.
- 1 Constantly check the battery as it may leak when it has been using for some time, replace the battery as soon as leaking appears. A leaking battery will damage the Meter.

## International Electrical Symbols

|   |  |
|---|--|
|  | AC (Alternating Current).                |
|  | DC (Direct Current).                     |
|  | Grounding.                               |
|  | Double Insulated.                        |
|  | Deficiency of Built-In Battery.          |
|  | Warning. Refer to the Operating Manual.  |
|  | Diode.                                   |
|  | Fuse.                                    |
|  | Continuity Test.                         |
|  | Conforms to Standards of European Union. |



### The Meter Structure (see figure 1)

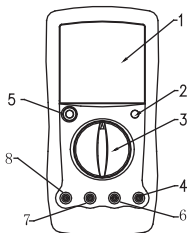







( figure 1 )

- ① LCD Display
- ② **HOLD** Button.
- ③ Rotary Switch
- ④ **COM** Input Terminal
- ⑤ **POWER**
- ⑥ Other Input Terminal.
- ⑦ **mA** Input Terminal
- ⑧ **20A** Input Terminal

## Rotary Switch

Below table indicated for information about the rotary switch positions.

| Rotary Switch Position   | Function                |
|--|-------------------------|
| <b>V</b>  | DC voltage measurement. |
| <b>V</b>  | AC voltage measurement. |
| <b>hFE</b>   | Transistor Test         |
| <b>A</b>  | AC Current Measurement  |
| <b>A</b>  | DC Current Measurement  |
| <b>Fcx</b>   | Capacitance Test        |
| <b>°C</b>  | Temperature Measurement |
| <b>Hz</b>  | Frequency Measurement   |
|           | Diode test              |
|           | Continuity test         |
| <b>Ω</b>   | Resistance measurement. |

## Functional Buttons

Below table indicated for information about the functional button operations

| Button                          | Operation Performed   |
|---------------------------------|---|
| <b>POWER</b><br>(Yellow Button) | Turn the Meter on and off. <ul style="list-style-type: none"><li>● Press down the <b>POWER</b> to turn on the Meter.</li><li>● Press up the <b>POWER</b> to turn off the Meter.</li></ul>                                       |
| <b>HOLD</b><br>(Blue Button)    | <ul style="list-style-type: none"><li>● Press <b>HOLD</b> once to enter hold mode.</li><li>● Press <b>HOLD</b> again to exit hold mode.</li><li>● In Hold mode, <b>H</b> is displayed and the present value is shown.</li></ul> |

## Display Symbols(1) (see figure 2)

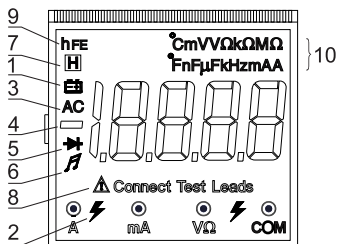

( figure 2)

| No. | Symbol               | Meaning  |
|-----|----------------------|--|
| 1   |                      | The battery is low.<br>⚠ Warning: To avoid false readings, replace the battery as soon as the battery indicator appears. |
| 2   |                      | Warning Symbol.  |
| 3   | AC                   | Indicator for AC voltage or current. The displayed value is the mean value.  |
| 4   | -                    | Indicates negative reading.  |
| 5   |                      | Test of diode.   |
| 6   |                      | The continuity buzzer is on.   |
| 7   |                      | Date hold is active.   |
| 8   | <br>Connect Terminal | Indicator of connecting test leads into different input terminals.   |

## Display Symbols(2) (see figure 2)

| No. | Symbol   | Meaning   |
|-----|--|---|
| 9   | <b>hFE</b>   | The Unit of Transistor Test   |
| 10  | <b>mV, V</b>   | V: Volts. The unit of voltage.<br>mV: Millivolt. $1 \times 10^{-3}$ or 0.001 volts.   |
|     | <b><math>\Omega</math>, k<math>\Omega</math>, M<math>\Omega</math></b> | $\Omega$ : Ohm. The unit of resistance.<br>k $\Omega$ : kilohm. $1 \times 10^3$ or 1000 ohms.<br>M $\Omega$ : Megaohm. $1 \times 10^6$ or 1,000,000 ohms.     |
|     | <b><math>\mu</math>A, mA, A</b>  | A: Amperes (amps). The unit of current.<br>mA: Milliamp. $1 \times 10^{-3}$ or 0.001 amperes.<br>$\mu$ A: Microamp. $1 \times 10^{-6}$ or 0.000001 amperes.   |
|     | <b><math>^{\circ}</math>C, <math>^{\circ}</math>F</b>                  | $^{\circ}$ C: Centigrade temperature<br>$^{\circ}$ F: Fahrenheit temperature  |
|     | <b>kHz</b>   | Hertz. The unit of frequency in cycles/second.<br>Kilohertz. $1 \times 10^3$ or 1,000 hertz.  |
|     | <b>nF, <math>\mu</math>F</b>   | F: Farad. The unit of capacitance.<br>$\mu$ F: Microfarad. $1 \times 10^{-6}$ or 0.000001 farads.<br>nF: Nanofarad. $1 \times 10^{-9}$ or 0.000000001 farads. |

## Measurement Operation(1)

### A. DC and AC Voltage Measurement (see figure 3)



**Warning**

To avoid harms to you or damages to the Meter from electric shock, never attempt to measure voltages higher than 1000 or 1000V rms although readings may be obtained.

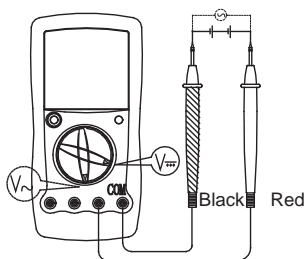

( figure 3)

The DC Voltage ranges are: 200mV, 2V, 20V, 200V and 1000V.  
The AC Voltage ranges are: 2V, 20V, 200V and 1000V

To measure DC Voltage, connect the Meter as follows:

1. Insert the red test lead into the  $V\Omega$  input terminal and the black test lead into the **COM** input terminal.
2. Set the rotary switch to an appropriate measurement position in  $V_{\text{---}}$  or  $V_{\sim}$  range.
3. Connect the test leads parallel across with the object to be measured.

The measured value shows on the display.

## Measurement Operation(2)

### Note

- If the value of voltage to be measured is unknown, use the maximum measurement position (1000V) and reduce the range step by step until a satisfactory reading is obtained.
- The LCD displays "1" indicating the existing selected range is overloaded, it is required to select a higher range in order to obtain a correct reading.
- In each range, the Meter has an input impedance of approx.  $10M\Omega$ . This loading effect can cause measurement errors in high impedance circuits. If the circuit impedance is less than or equal to  $10k\Omega$  the error is negligible (0.1% or less).
- When DC voltage measurement has been completed, disconnect the connection between the testing leads and the circuit under test, and remove the testing leads away from the input terminal of the Meter.

### B. DC and AC Current Measurement (see figure 4)

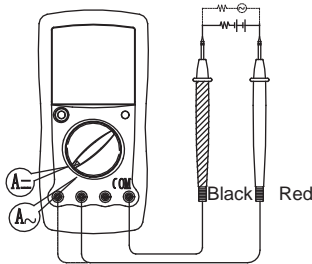

( figure 4)

## Measurement Operation(3)



### Warning

**Never attempt an in-circuit current measurement where the open circuit voltage between terminals and ground is greater than 60V DC or 30V rms in AC. If the fuse burns out during measurement, the Meter may be damaged or the operator himself may be hurt. Use proper terminals, function, and range for the measurement. When the testing leads are connected to the current terminals, do not parallel them across any circuit.**

The DC Current Measurement has 3 measurement positions on the rotary switch: 2mA, 200mA and 20A  
The AC Current Measurement has 3 measurement positions on the rotary switch: 20mA, 200mA and 20A

To measure current, do the following:

1. Turn off power to the circuit. Discharge all high-voltage capacitors.
2. Insert the red test lead into the **20A** or **mA** input terminal and the black test lead into the **COM** terminal. When you measure current below 200mA, please insert the red test lead into the **mA** input terminal. When you measure 200mA or above, insert the red test lead into the **20A** input terminal.
3. Set the rotary switch to an appropriate measurement position in **A $\overline{\text{---}}$**  or **A $\sim$**  range.
4. Break the current path to be tested. Connect the red test lead in serial to the more positive side of the break and the black test lead to the more negative side of the break.
5. Turn on power to the circuit.  
The measured value shows on the display.



## Measurement Operation(4)

### Note

- 1 If the value of current to be measured is unknown, use the maximum measurement position, and reduce the range step by step until a satisfactory reading is obtained.
- 1 For safety sake, the measuring time for high current should be less than 10 seconds and the interval time between 2 measurements should be greater than 15 minutes
- 1 When current measurement has been completed, disconnect the connection between the testing leads and the circuit under test, and remove the testing leads away from the input terminal of the Meter.

### C. Measuring Resistance (see figure 5)

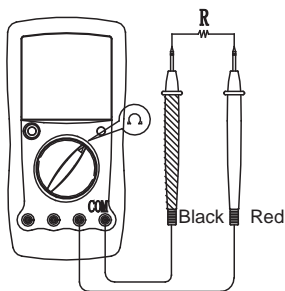

( figure 5)



### Warning

**To avoid damages to the Meter or to the devices under test, disconnect circuit power and discharge all the high-voltage capacitors before measuring resistance.**

The resistance ranges are: 200Ω, 2kΩ, 20kΩ, 2MΩ and 200MΩ

## Measurement Operation(5)

To measure resistance, connect the Meter as follows:

1. Insert the red test lead into the  $V\Omega$  input terminal and the black test lead into the **COM** terminal.
2. Set the rotary switch to an appropriate measurement position in  $\Omega$  range.
3. Connect the test leads parallel across with the object being measured.

The measured value shows on the display.

### Note

- The test leads can add 0.1  $\Omega$  to 0.3 of error to the low-resistance( 200 $\Omega$ ) measurement.
- For high resistance(>1M $\Omega$ ), it is normal taking several seconds to obtain a stable reading..
- When there is no input, for example in open circuit condition, the Meter displays "1".
- When resistance measurement has been completed, disconnect the connection between the testing leads and the circuit under test, and remove the testing leads away from the input terminal of the Meter.

### D. Measuring Diodes and Continuity (see figure 6)

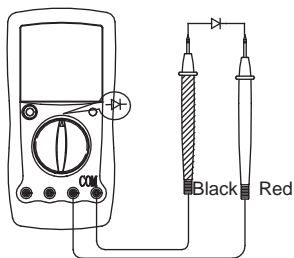

( figure 6)

## Measurement Operation(6)



### Warning

To avoid damage to the Meter or to the equipment under test, disconnect circuit power and discharge all high-voltage capacitors before measuring diodes.

To avoid harms to you, never attempt to input voltages higher than 60V DC or 30V rms in AC

### Measuring Diodes

Use the diode test to check diodes, transistors, and other semiconductor devices. The diode test sends a current through the semiconductor junction, and then measures the voltage drop across the junction. A good silicon junction drops between 0.5V and 0.8V

To test out a diode out of a circuit, connect the Meter as follows:

1. Insert the red test lead into the  $v\Omega$  input terminal and the black test lead into the **COM** terminal
2. Set the rotary switch to
3. For forward voltage drop readings on any semiconductor component, place the red test lead on the component's anode and place the black test lead on the component's cathode.

The measured value shows on the display.

### Note

- 1 In a circuit, a good diode should still produce a forward voltage drop reading of 0.5V to 0.8V; however; the reverse voltage drop reading can vary depending on the resistance of other pathways between the probe tips.
- 1 Connect the test leads to the proper terminals as said above to avoid error display. The LCD will display "1" indicating open-circuit for wrong connection. The unit of diode is Volt (V), displaying the positive-connection voltage-drop value.

### Measurement Operation(7)

- 1 The open-circuit voltage is around 3V.
- 1 When diode testing has been completed, disconnect the connection between the testing leads and the circuit under test, and remove the testing leads away from the input terminal of the Meter.

#### Testing for Continuity

To test for continuity, connect the Meter as below:

1. Insert the red test lead into  $V\Omega$  terminal and the black test lead into the **COM** terminal.
2. Set the rotary switch to  $\rightarrow \text{A}$ .
3. Connect the test leads across with the object being measured.
4. The buzzer does not sound if the resistance of a circuit under test is  $\leq 70\ \Omega$   
The tested circuit resistance value simultaneously shows on the display and the unit is  $\Omega$ .

#### Note

- 1 When continuity testing has been completed, disconnect the connection between the testing leads and the circuit under test, and remove the testing leads away from the input terminal of the Meter.

### E. Frequency Measurement (see figure 7)

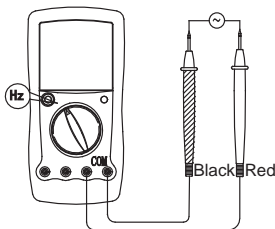

( figure 7)

## Measurement Operation(8)

### Warning

To avoid harms to you, never attempt to input voltages higher than 60V DC or 30V rms in AC. When the voltage of tested frequency signal is higher than 30V rms, the reading obtained may not be without the accuracy.

The frequency measurement range is 20kHz. To measure frequency, connect the Meter as follows:

1. Insert the red test lead into the **V $\Omega$**  terminal and the black test lead into the **COM** terminal.
2. Set the rotary switch to **20kHz** range.
3. Parallel connect the test leads across with the object being measured.

The measured value shows on the display.

### Note

- 1 When Hz measurement has been completed, disconnect the connection between the testing leads and the circuit under test, and remove the testing leads away from the input terminals of the Meter.

## F.Temperature Measurement (see figure 8)

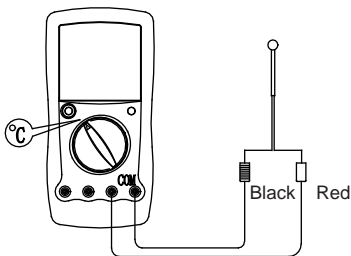

( figure 8)

## Measurement Operation(9)

### Warning

To avoid harm to you or damages to the Meter, never attempt to measure voltages higher than 60V in DC or 30V rms in AC although readings may be obtained. During testing, the operating temperature must be within 18-23°C, otherwise the obtained reading may not be correct especially measuring low temperature.

The temperature measurement range is from -40°C~1000°C. To measure temperature, connect the Meter as follows:

1. Insert the “+” and “-“ temperature probe into corresponding **VΩ** and **COM** terminal.
2. Set the rotary switch to °C .
3. Place the temperature probe's tip to the object being measured.

The measured value shows on the display.

### Note

- 1 When there is no temperature probe insert inside the Meter, the LCD displays the Meter inside temperature
- 1 The included temperature probe can only be measured up to 250°C.. For any measurement higher than that, the rod type temperature probe must be used instead. When temperature measurement has been completed, remove the temperature probe away from the input terminal of the Meter.

## Measurement Operation(10)

### G. Capacitance Measurement (see figure 9)

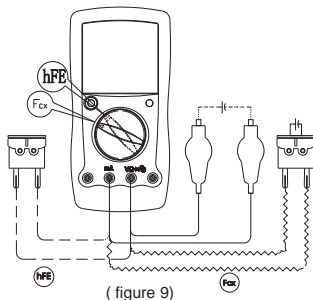

#### **Warning**

To avoid damage to the Meter or to the equipment under test, disconnect circuit power and discharge all high-voltage capacitors before measuring capacitance. Use the DC voltage function to confirm that the capacitor is discharged.

To avoid harms to you, never attempt to input voltages higher than 60V DC or 30V rms AC.

Capacitance measurement has 4 measurement positions on the rotary switch : 2nF, 20nF, 2 $\mu$ F and 20  $\mu$  F.

To measure capacitance, connect the Meter as follows:

1. According to the size of the tested object's leads, select multi-purpose socket or test clip to insert into the **mA** and **V $\Omega$**  terminal.
2. Set the rotary switch to an appropriate measurement position in **Fcx** range.
3. Insert the tested object into the corresponding jack of the multi-purpose socket or connect the test clip to the object being measured.

The measured value shows on the display.

## Measurement Operation(11)

### Note

- 1 If the value of capacitance to be measured is unknown, use the maximum measurement position, and reduce the range step by step until a satisfactory reading is obtained.
- 1 When the tested capacitor is shorted or the capacitor value is overloaded, the LCD display “1”.
- 1 To minimize the measurement error caused by the distributed capacitor, the testing lead should be as short as possible.
- 1 To increase the accuracy especially when measuring small capacitance range, the correct reading is subtracting the test lead open circuit value from the display value.
- 1 It is normal to take a longer time when testing a high capacitor value.
- 1 For testing the capacitor with polarity, connect the red clip or red test lead to anode and black clip or black test lead to cathode.
- 1 It takes some time for zeroing when you switching over the rotary switch, the floating readings shows on the display during this process do not affect the final testing accuracy.
- 1 When capacitance testing has been completed, remove the testing leads away from the multi-purpose socket, and remove multi-purpose socket or test clip away from the input terminal of the Meter.



## Measurement Operation(12)

### H. Measuring Transistor (see figure 9)



#### **Warning**

To avoid harms to you, please do not attempt to input voltages higher than 60V DC or 30V rms AC.

To measure transistor, connect the Meter as follows:

1. Insert the multi-purpose socket into the **V $\Omega$**  and **mA** terminal.
2. Set the rotary switch to **hFE** range.
3. Insert the NPN or PNP type transistor to be tested into the corresponding jack of the multi-purpose socket  
The measured nearest transistor value shows on the display.

#### **Note**

- 1 When transistor measurement has been completed, remove the transistor to be tested away from the multi-purpose socket, and remove multi-purpose socket away from the input terminal of the Meter.

## Sleep Mode

To preserve battery life, the Meter automatically turns off if you do not turn the rotary switch or press any button for around 15 minutes. When the Meter is under sleep mode, it consumes 10  $\mu$ A current.

To activate the Meter, press **POWER** for two times

## Operation of Hold Mode





### Warning

**To avoid possibility of electric shock, do not use Hold mode to determine if circuits are without power. The Hold mode will not capture unstable or noisy readings.**

To use the Hold mode as follows:

- 1 Press **HOLD** to enter Hold mode.
- 1 Press **HOLD** again to exit Hold mode.
- 1 In Hold mode,  is displayed.

### General Specifications

- Maximum Voltage between any Terminals and grounding: Refer to different range input protection voltage.
-  Fused Protection for **mA** Input Terminal : **CE Version:** 0.5A, 250V fast type,  $\phi$ 5x20mm.  
 $V \Omega^{\circ}C$  input jack's fuse:0.63A,250V fast type,  $\phi$ 5x20mm, to be used on capacitance,temperature and transistor testing input protection.
- 1  **20A** Input Terminal : Unfused.
- 1 Maximum Display : 19999,updates 2~3 times/second.
- 1 Range : Manual ranging.
- 1 Polarity display : Automatically
- 1 Overloading : Display "1".
- 1 Battery Deficiency : Display "  ".
- 1 Data Holding : Display ""
- 1 Temperature: Operating:  $0^{\circ}C \sim 40^{\circ}C (32^{\circ}F \sim 104^{\circ}F)$ ;  
Storage:  $-10^{\circ}C \sim 50^{\circ}C (14^{\circ}F \sim 122^{\circ}F)$ .
- 1 Relative Humidity :  $\leq 75\%$  @  $0^{\circ}C \sim$  below  $30^{\circ}C$ ;  
 $\leq 50\%$  @  $30^{\circ}C \sim 40^{\circ}C$
- 1 Altitude: Operating : 2000m; Storage: 10000m.
- 1 Electromagnetic Compatibility: In a radio field of 1 V/m, Overall Accuracy = Specified Accuracy + 5% of Range; in a radio field of more than 1 V/m, no assigned accuracy is specified.
- 1 Battery Type : One piece of 9V (NEDA1604 or 6F22 or 006P).
- 1 Dimensions : 179x88x39mm.
- 1 Weight : Approx.380g (including holster and battery)
- Safety/Compliances : IEC61010 CAT II 1000V, CATIII 600V overvoltage and double insulation standard.
- Certificate: **CE**

## Accuracy Specifications(1)

Accuracy:  $\pm$ (% reading + b digits), guarantee for 1 year.

Operating temperature: 18°C~28°C.

Relative humidity:  $\leq$  75%RH.

### A. DC Voltage

| Range | Resolution | Accuracy        | Overload Protection |
|-------|------------|-----------------|---------------------|
| 200mV | 0.01mV     | $\pm$ (0.05%+3) | 250V DC / V AC      |
| 2V    | 0.0001V    | $\pm$ (0.1%+3)  | 1000V rms           |
| 20V   | 0.001V     |                 |                     |
| 200V  | 0.01V      |                 |                     |
| 1000V | 0.1V       | $\pm$ (0.15%+5) |                     |

Remarks: **Input Impedance:** approx.10M $\Omega$

### B. AC Voltage

| Range | Resolution | Accuracy        | Overload Protection |
|-------|------------|-----------------|---------------------|
| 2V    | 0.0001V    | $\pm$ (0.5%+10) | 1000V rms           |
| 20V   | 0.001V     |                 |                     |
| 200V  | 0.01V      |                 |                     |
| 1000V | 0.1V       | $\pm$ (1%+10)   |                     |

Remarks:

- **Input Impedance:** approx.2M $\Omega$
- **Frequency response:** 40Hz~400Hz
- Displays effective value of sine wave (mean value response).

### C. DC Current

| Range | Resolution | Accuracy       | Overload Protection                                  |
|-------|------------|----------------|--|
| 2mA   | 0.0001mA   | $\pm$ (0.5%+5) | CE Version:Fuse 0.5A, 250V, fast type, $\phi$ 5x20mm |
| 200mA | 0.01mA     | $\pm$ (0.8%+5) |  |
| 20A   | 0.001A     | $\pm$ (2%+10)  | Un-Fused   |

### Accuracy Specifications(2)

#### Remarks:

- **At 20A Range:**  
For continuous measurement  $\leq 10$  seconds and interval time between 2 measurement greater than 15 minutes.
- **Measuring Voltage Drop:** Full Range is 200mV.

#### D. AC Current

| Range | Resolution | Accuracy        | Overload Protection  |
|-------|------------|-----------------|--|
| 20mA  | 0.001mA    | $\pm(0.8\%+10)$ | CE Version:Fuse<br>0.5A, 250V, fast<br>type, $\phi 5 \times 20$ mm |
| 200mA | 0.01mA     | $\pm(1.2\%+10)$ |  |
| 20A   | 0.001A     | $\pm(2.5\%+10)$ | Un-Fused   |

#### Remarks:

- **Frequency response:** 40Hz~400Hz
- **At 20A Range:**  
For continuous measurement  $\leq 10$  seconds and interval time between 2 measurement greater than 15 minutes
- **Measuring Voltage Drop:** Full Range is 200mV.
- Displays effective value of sine wave (mean value response).

#### E. Resistance Test



| Range         | Resolution       | Accuracy  | Overload Protection |
|---------------|------------------|---|---------------------|
| 200 $\Omega$  | 0.01 $\Omega$    | $\pm(0.5\%+10) + \text{Test Lead Short Circuit Resistance}$ | 250V rms            |
| 2k $\Omega$   | 0.0001k $\Omega$ | $\pm(0.3\%+1)$  |                     |
| 20k $\Omega$  | 0.001k $\Omega$  |   |                     |
| 2M $\Omega$   | 0.0001M $\Omega$ |   |                     |
| 200M $\Omega$ | 0.01M $\Omega$   | $\pm 5\%(\text{reading}-1000)+10)$                          |                     |

## Accuracy Specifications(3)

### Remarks:

- At  $200M\Omega$  testing leads is shorted, the displays shows 1000 digit. To obtain a correct reading, subtract these 1000 digits from the readings.
- To obtain accurate readings when measuring  $200\Omega$  short-circuit the testing leads beforehand and record the reading obtained (called this reading as X). (X) is the additional resistance from the test lead. Then use the equation:  
measured resistance value (Y) - (X) = accurate readings of resistance.

## F. Diodes and Continuity Test

| Function        | Range   | Resolution   | Overload Protection | Remarks  |
|-----------------|---|--------------|---------------------|--|
| Diodes          |    | 0.1mV        | 250V rms            | Open circuit voltage approx.2.8 v  |
| Continuity Test |  | 0.1 $\Omega$ |                     | The buzzer does not sound if the resistance of a circuit under test is $\leq 70\Omega$ |

## G.Frequency

| Range | Resolution | Accuracy       | Overload Protection | Sensitivity  |
|-------|------------|----------------|---------------------|--------------|
| 20kHz | 1kHz       | $\pm(1.5\%+5)$ | 250V rms            | $\leq 200mV$ |

### Remarks:

- The tested inductance:  $Q \geq 10$ , Internal resistance  $\leq 1.3k\Omega$
- When the tested inductance is  $>1H$ , the obtained reading is only for reference

## Accuracy Specifications(4)

### H. Temperature

| Range        | Resolution | Accuracy | Overload Protection |
|--------------|------------|----------|---------------------|
| -40°C~0°C    | 1°C        | ±(3%+40) | 250V rms            |
| 0°C~400°C    |            | ±(1%+30) |                     |
| 400°C~1000°C |            | ±(2%+50) |                     |

### I. Capacitance

| Range | Resolution | Accuracy | Overload Protection |
|-------|------------|----------|---------------------|
| 2nF   | 0.0001nF   | ±(3%+40) | 250V rms            |
| 20nF  | 0.001nF    | ±(4%+10) |                     |
| 2μF   | 0.0001μF   |          |                     |
| 20μF  | 0.001μF    |          |                     |

#### Remarks:

- Testing signal is approx.: 400Hz 40mVrms.

### J. Transistor test

| Range | Resolution | Remarks  | Testing Conditions                               | Overload Protection |
|-------|------------|--|--|---------------------|
| hFE   | 1β         | The display value is the tested transistor (NPN, PNP) nearest value of hFE (0 ~ 1000β) | I <sub>bo</sub> ≈ 10μA<br>V <sub>ce</sub> ≈ 2.8V | 250V rms            |

## Maintenance(1)

This section provides basic maintenance information including battery and fuse replacement instruction.



### Warning

**Do not attempt to repair or service your Meter unless you are qualified to do so and have the relevant calibration, performance test, and service information. To avoid electrical shock or damage to the Meter, do not get water inside the case.**

#### A. General Service

- 1 Periodically wipe the case with damp cloth and mild detergent. Do not use chemical solvent.
- 1 To clean the terminals with cotton bar with detergent, as dirt or moisture in the terminals can affect readings.
- 1 Turn the Meter off when it is not in use and take out the battery when not using for a long time.
- 1 Do not store the Meter in place of humidity, high temperature, explosive, inflammable and strong magnetic field

#### B. Replacing the Fuses (see figure 10)

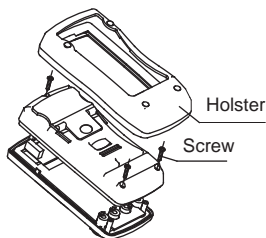

( figure 10)



## Maintenance(2)

### Warning

**To avoid electrical shock or arc blast, or personal injury or damage to the Meter, use specified fuses ONLY in accordance with the following procedure.**

To replace the Meter's fuse:

1. Turn the Meter off and remove all connections from the terminals.
2. Remove the holster from the Meter.
3. Remove the 3 screws from the case bottom, and separate the case top from the case bottom.
4. Remove the fuse by gently prying one end loose, then take out the fuse from its bracket.
5. Install ONLY replacement fuses with the identical type and specification and make sure the fuse is fixed firmly in the bracket.  
Fuse 1: 0.5A, 250V, fast type,  $\phi$  5x20mm  
Fuse 2: 0.63A, 250V, fast type,  $\phi$  5x20mm
6. Rejoin the case bottom and case top, and reinstall the 3 screws and holster.

Replacement of the fuses is seldom required. Burning of a fuse always results from improper operation.

### C. Replacing the Battery (see figure 10)

#### Warning

**To avoid false readings, which could lead to possible electric shock or personal injury, replace the battery as soon as the battery indicator “” appears.**

To replace the Meter's battery:

1. Turn the Meter power off and remove all connections from the terminals.
2. Remove the holster from the Meter.

## Maintenance(3)

3. Remove the 3 screws from the case bottom, and separate the case top from the case bottom.
4. Remove the battery from the battery connector.
5. Replace with a new 9V battery (NEDA1604, 6F22 or 006P).
6. Rejoin the case bottom and case top, and reinstall the 3 screws and the holster.

\*\* END \*\*

This operating manual is subject to change without notice.

**UNI-T®**

**Model UT58E: OPERATING MANUAL**

# UNI-T®

**Model UT58E: OPERATING MANUAL**

©Copyright 2001 Uni-Trend International Limited.  
All rights reserved.

Manufacturer: UNI-TREND TECHNOLOGY(DONG GUAN)LIMITED  
Address: Dong Fang Da Dao, Bei Shan Dong Fang Industrial  
Development District, Hu Men Town, Dong Guan City,  
Guang Dong Province, China

Headquarters: Uni-Trend International Limited  
Address: Rm901, 9/F, Nanyang Plaza 57 Hung To Road  
Kwun Tong Kowloon, Hong Kong

Tel: (852) 2950 9168  
Fax: (852) 2950 9303  
Email: [info@uni-trend.com](mailto:info@uni-trend.com)  
<http://www.uni-trend.com>