

UNI-T®

**Model UT209
OPERATING MANUAL**

Table of Contents

Title	Page
Overview	3
Unpacking Inspection	4
Safety Information	5
Rules For Safe Operation	6
International Electrical Symbols	9
The Meter Structure	10
Functional Buttons	11
The Effectiveness of Functional Buttons	13
Display Symbols	14
Measurement Operation	17
A. DC/AC Voltage Measurement	17
B. Measuring Resistance	19
C. Testing Diodes	21
D. Testing for Continuity	23
E. Frequency Measurement	25
F. DC Current Measurement	27

Title	Page
G. AC Current Measurement	30
Sleep Mode	32
Specifications	33
A. General Specifications	33
B. Environmental Requirements	34
Accuracy Specifications	35
A. DC Voltage	35
B. AC Voltage	36
C. Resistance	37
D. Diode Test	38
E. Continuity Test	38
F. Frequency	39
G. DC Current	40
H. AC Current	40
Maintenance	41
A. General Service	41
B. Replacing the Battery	42

Overview

This Operating Manual covers information on safety and cautions. Please read the relevant information carefully and observe all the **Warnings** and **Notes** strictly.

Warning

To avoid electric shock or personal injury, read the “Safety Information” and “Rules for Safe Operation” carefully before using the Meter.

Digital Clamp Multimeter **Model UT209** (hereafter referred to as “the Meter”) are 3 3/4 digits with steady operations, fashionable structure and highly reliable measuring instrument. The Meter uses large scale of integrated circuit with double integrated A/D converter as its core and has full range overload protection.

The Meter can measure AC/DC Voltage, AC/DC Current, Frequency, Resistance, Diodes, Continuity and etc.

Unpacking Inspection

Open the package case and take out the Meter. Check the following items carefully to see any missing or damaged part:

Item	Description	Qty
1	English Operating Manual	1 piece
2	Test Lead	1 pair
3	Tool Box	1 piece
4	9V Battery (NEDA1604A or 6LF22)	1 piece

In the event you find any missing or damage, please contact your dealer immediately.

Safety Information

This Meter complies with the standards IEC61010: in pollution degree 2, overvoltage category (CAT. II 600V, CAT. III 300V) and double insulation.

CAT. II: Local level, appliance, PORTABLE EQUIPMENT etc., with smaller transient overvoltages than CAT. III.

CAT. III: Distribution level, fixed installation, with smaller transient overvoltages than CAT. IV

Use the Meter only as specified in this operating manual, otherwise the protection provided by the Meter may be impaired.

In this manual, a **Warning** identifies conditions and actions that pose hazards to the user, or may damage the Meter or the equipment under test.

A **Note** identifies the information that user should pay attention to.

International electrical symbols used on the Meter and in this Operating Manual are explained on page 9.

Rules For Safe Operation

Warning

To avoid possible electric shock or personal injury, and to avoid possible damage to the Meter or to the equipment under test, adhere to the following rules:











- Before using the Meter inspect the case. Do not use the Meter if it is damaged or the case (or part of the case) is removed. Look for cracks or missing plastic. Pay attention to the insulation around the connectors.
- Inspect the test leads for damaged insulation or exposed metal. Check the test leads for continuity. Replace damaged test leads with identical model number or electrical specifications before using the Meter.
- Do not apply more than the rated voltage, as marked on the Meter, between the terminals or between any terminal and grounding.
- When measurement has been completed, disconnect the connection between the test leads and the circuit under test, remove the testing leads away from the input terminals of the Meter and turn the Meter power off.
- The rotary switch should be placed in the right position and no any

changeover of range shall be made during measurement is conducted to prevent damage of the Meter.

- Do not carry out the measurement when the Meter's back case and battery compartment are not closed to avoid electric shock.
- Do not input higher than 600V between the two Meter's input terminal to avoid electric shock and damages to the Meter.
- When the Meter working at an effective voltage over 70V in DC or 33V rms in AC, special care should be taken for there is danger of electric shock.
- Use the proper terminals, function, and range for your measurements.
- Do not use or store the Meter in an environment of high temperature, humidity, explosive, inflammable and strong magnetic field. The performance of the Meter may deteriorate after dampened.
- When using the test leads, keep your fingers behind the finger guards.
- To avoid electric shock, do not touch the bare wires, connectors, unused input terminals or the circuit under testing during measurement.
- Disconnect circuit power and discharge all high-voltage capacitors before testing resistance, continuity and diode.
- Replace the battery as soon as the battery indicator  appears. With a low battery, the Meter might produce false readings that can lead to electric shock and personal injury.

- **When servicing the Meter, use only the same model number or identical electrical specifications replacement parts.**
- **The internal circuit of the Meter shall not be altered at will to avoid damage of the Meter and any accident.**
- **Soft cloth and mild detergent should be used to clean the surface of the Meter when servicing. No abrasive and solvent should be used to prevent the surface of the Meter from corrosion, damage and accident.**
- **The Meter is suitable for indoor use.**
- **Turn the Meter off when it is not in use and take out the battery when not using for a long time.**
- **Constantly check the battery as it may leak when it has been using for some time, replace the battery as soon as leaking appears. A leaking battery will damage the Meter.**

International Electrical Symbols

	AC (Alternating Current)
	DC (Direct Current)
	AC or DC
	Grounding
	Double Insulated
	Warning. Refer to the Operating Manual
	Deficiency of Built-In Battery
	Continuity Test
	Diode
	Danger of High Voltage
	Conforms to Standards of European Union

The Meter Structure (see figure 1)

1. Hand Guards: to protect user's hand from touching the dangerous area.
2. Trigger: press the lever to open the transformer jaws. When the pressure on the lever is released, the jaws will close.
3. Functional Buttons
4. Input Terminals
5. LCD Display
6. Rotary Switch
7. Transformer Jaw: designed to pick up the AC and DC current flowing through the conductor. It could transfer current to voltage. The tested conductor must vertically go through the Jaw center.

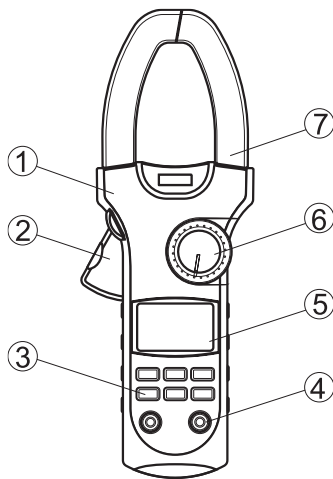





Figure 1

Functional Buttons





Below table indicated for information about the functional button operations.

Button	Operation Performed
SELECT	Press SELECT button to select the alternate functions including $V\sim$, and $\bullet \rightarrow \Omega$
PMAX/PMIN	<ul style="list-style-type: none"> ● Press and hold for 2 seconds to enter that function internal calibration. ● Press the button once to start recording of maximum peak value. ● Press the button again to start recording of minimum peak value. ● Press and hold for one second to exit PMAX/PMIN mode.
	<ul style="list-style-type: none"> ● Press once to turn the display backlight on. ● It will automatically off after around 15 seconds.
HOLD	<ul style="list-style-type: none"> ● Press HOLD to enter the Hold mode in any mode, the Meter beeps. ● Press HOLD again to exit the Hold mode to return to measurement mode, the Meter beeps.

Button	Operation Performed
HOLD	<ul style="list-style-type: none">● Turn the rotary switch or press SELECT button can also exit Hold mode.● Press HOLD button for 2 seconds when turning on the Meter to display full icon.
Hz	When the Meter is at V  , A  , and A  , press the button to measure frequency. But the frequency readings obtained from these ranges are only for reference,
ZERO	<ul style="list-style-type: none">● Press ZERO to display the present value as stored value and display zero. After that, all the measurement result displayed will automatically subtract the stored value.● Press ZERO again to display the stored value.● Press and hold ZERO to exit and back to normal operation.

The Effectiveness of Functional Buttons

Not every functional buttons can be used on every rotary switch positions. Below table describe which functional buttons can be used on which rotary switch positions

Rotary Switch Positions	Functional Buttons					
	SELECT	MAX/MIN		HOLD		ZERO
$V \sim$	•	•	•	•	•	•
$\cdot \parallel \rightarrow \Omega$	•	•	•	•	N/A	•
%Hz	N/A	•	•	•	N/A	•
44A 	N/A	•	•	•	•	•
1000A 	N/A	•	•	•	•	•
40A \sim	N/A	•	•	•	•	N/A
1000A \sim	N/A	•	•	•	•	N/A

Display Symbols (see figure 2)

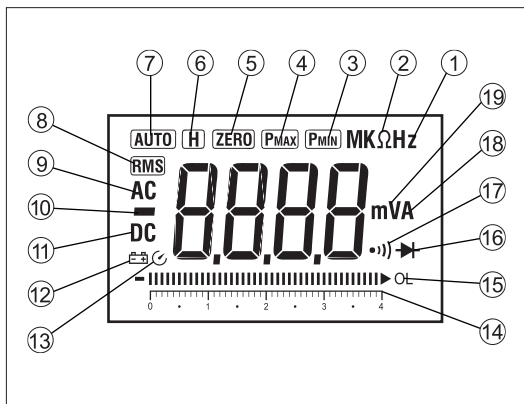

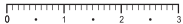





Figure 2

Number	Symbol	Meaning
1	Hz, kHz, MHz	Hz: Hertz. The unit of frequency. KHz: Kilohertz. 1×10^3 or 1000 hertz. MHz: Megahertz. 1×10^6 or 1,000,000 hertz.
2	Ω , kΩ, MΩ	Ω : Ohm. The unit of resistance. k Ω :Kilohm. 1×10^3 or 1000 ohms M Ω :Megohm. 1×10^6 or 1,000,000 ohms
3	PMAX	Maximum peak reading displayed
4	PMIN	Minimum peak reading displayed
5	ZERO	Indicator for relative value zeroing
6	H	Data hold is active
7	AUTO	The Meter is in the auto range mode in which the Meter automatically selects the range with the best resolution.
8	RMS	True RMS indicator
9	AC	Indicator for AC voltage or current
10	—	Indicates negative reading
11	DC	Indicator for DC voltage

Number	Symbol	Meaning
12		The battery is low. ⚠ Warning: To avoid false readings, which could lead to possible electric shock or personal injury, replace the battery as soon as the battery indicator appears.
13		Sleep mode is on
14		Analogue bar graph ruler
15		Analogue Bar Graph
16		Test of diode
17		The continuity buzzer is on
18	A	Amperes (amps). The unit of current.
19	mV, V	Volts. The unit of voltage. mV: Millivolt. 1×10^{-3} or 0.001 volts

Measurement Operation

A.DC/AC Voltage Measurement (see figure 3)

Warning

To avoid harms to you or damages to the Meter from electric shock, do not attempt to measure voltages higher than 600V AC/DC, although readings may be obtained.

The DC Voltage ranges are:
400mV, 4V, 40V, 400V and 600V

The AC Voltage ranges are:
400mV, 4V, 40V, 400V and 600V

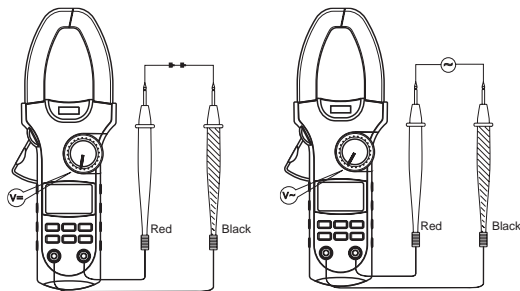

Figure 3

To measure DC/AC voltages, connect the Meter as follows:

1. Insert the red test lead into the **V Ω Hz** terminal and black test lead into the **COM** terminal.
2. Set the rotary switch to **V $\sqrt{\sim}$** . DC measurement mode and auto ranging is a default. Press **SELECT** to switch to AC measurement mode.
3. Press **fHz** button to measure frequency , but the frequency readings obtained from this range is only for reference.
4. Connect the test leads across with the object being measured.
The measured value shows on the display.

Note

- When DC/AC voltage measurement has been completed, disconnect the connection between the testing leads and the circuit under test and remove testing leads from the input terminals.

Model UT209: OPERATING MANUAL

B.Measuring Resistance (see figure 4)**⚠ Warning**

To avoid damages to the Meter or to the devices under test, disconnect circuit power and discharge all the high-voltage capacitors before measuring resistance.

The resistance ranges are:
400 Ω , 4k Ω , 40k Ω , 400k Ω and 40M Ω

To measure resistance, connect the Meter as follows:

1. Insert the red test lead into the **V Ω Hz** terminal and black test lead into the **COM** terminal.
2. Set the rotary switch to **Ω** Resistance measurement is a default or press **SELECT** to switch to **\rightarrow** measurement mode.

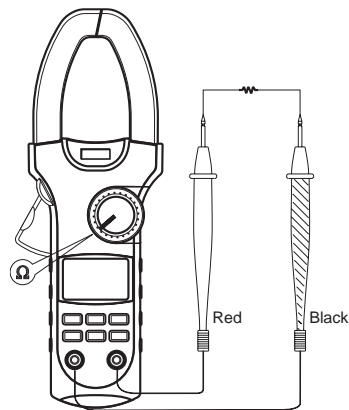

Figure 4

3. Connect the test leads across with the object being measured.
The measured value shows on the display.

Note

- To obtain a more precise reading, you could remove the objects being tested from the circuit when measuring.
- When resistance measurement has been completed, disconnect the connection between the testing leads and the circuit under test and remove testing leads from the input terminals.

C. Testing Diodes (see figure 5)

Warning

To avoid damages to the Meter or to the devices under test, disconnect circuit power and discharge all the high-voltage capacitors before testing diodes.

Use the diode test to check diodes, transistors, and other semiconductor devices. The diode test sends a current through the semiconductor junction, then measure the voltage drop across the junction. A good silicon junction drops between 0.5V and 0.8V.

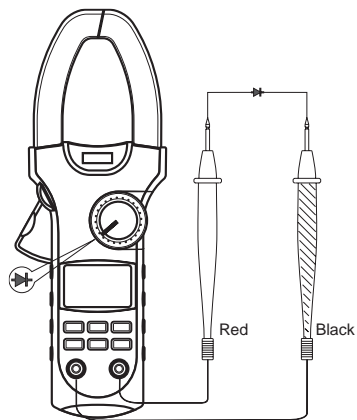

Figure 5

To test the diode out of a circuit, connect the Meter as follows:

1. Insert the red test lead into the **VΩHz** terminal and black test lead into the **COM** terminal.
2. Set the rotary switch to **•)→Ω** Press **SELECT** to switch to **→|** measurement mode.
3. For forward voltage drop readings on any semiconductor component, place the red test lead on the component's anode and place the black test lead on the component's cathode.

Note

- To obtain a more precise reading, you could remove the objects being tested from the circuit when measuring.
- When diode testing has been completed, disconnect the connection between the testing leads and the circuit under test and remove testing leads from the input terminals.

D. Testing for Continuity (see figure 6)

Warning

To avoid damages to the Meter or to the devices under test, disconnect circuit power and discharge all the high-voltage capacitors before measuring continuity.

To test for continuity, connect the Meter as follows:

1. Insert the red test lead into the **VΩHz** terminal and the black test lead into the **COM** terminal.
2. Set the rotary switch to $\bullet||| \rightarrow \Omega$ and press **SELECT** button to select $\bullet|||$ measurement mode.
3. The buzzer sounds if the resistance of a circuit under test is less than 30Ω .
4. The buzzer may or may not sound if the resistance of a circuit under test is between 30Ω to 100Ω .
5. The buzzer does not sound if the resistance of

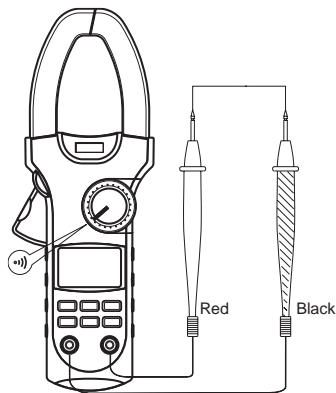

Figure 6

a circuit under test is higher than 100Ω

Note

- When continuity testing has been completed, disconnect the connection between the testing leads and the circuit under test and remove testing leads from the input terminals.

E. Frequency Measurement (see figure 7)

Warning

To avoid harms to you or damages to the Meter from electric shock, do not attempt to measure voltages higher than 600V AC/DC, although readings may be obtained.

The frequency ranges are:
4kHz, 40kHz, 400kHz, 4MHz and 40MHz.

To measure frequency, connect the Meter as follows

1. Insert the red test lead into the **V Ω Hz** terminal and the black test lead into the **COM** terminal.
2. Set the rotary switch to **Hz**.
3. Connect the test leads across with the object being measured.

The measured value shows on the display.

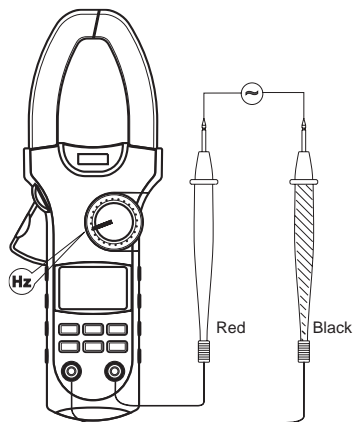

Figure 7

Note

- The maximum amplitude must not exceed 30Vrms.
- When frequency measurement has been completed, disconnect the connection between the testing leads and the circuit under test, and remove the testing leads away from the input terminals of the Meter.

Model UT209: OPERATING MANUAL

F. DC Current Measurement (see figure 8)

 **Warning**

The operating temperature must be 0°C ~ 40°C when measuring current.

The measurement ranges of current are: 40A_{AC} and 1000A_{AC} .

To measure current, do the following:

1. Set the rotary switch to 40A_{AC} or 1000A_{AC} .
2. When the Meter is at 400A_{AC} range, the LCD displays 00.00. Press **ZERO** for zeroing if it does not display zero. It allows 10 bouncing digits after zeroing.
3. When the Meter is at 1000A_{AC} range, it automatically separate 400A_{AC} and 1000A_{AC} range. The initial stage is 400A_{AC} , the Meter displays 0.0. Press **ZERO** for zeroing if it does

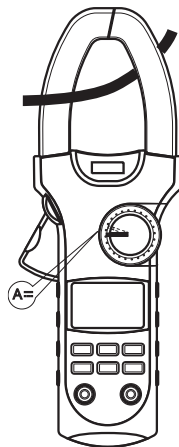

Figure 8

not display zero. When the testing current is greater than **400A**, it is not necessary to zero.

4. Hold the Meter tight, don't release. The Hall components are very sensitive not only to the magnet but also to heat and machine reaction force. Any shock will cause the changing in reading in the short time.
5. Press the lever to open the transformer jaw.
6. Center the conductor within the transformer jaw, then release the Meter slowly until the transformer jaw is completely closed, Make sure the conductor to be tested is placed at the center of the transformer jaw, otherwise it will cause deviation. The Meter can only measure one conductor at a time, to measure more than one conductor at a time will cause deviation.

Below test method can obtain more accurate DC current:

1. Power off the tested conductor current,
2. Press the lever to open the transformer jaw.
3. Center the conductor within the transformer jaw, then release the Meter slowly until the transformer jaw is completely closed. Make sure the conductor to be tested is placed at the center of the transformer jaw, otherwise it will cause ± 1.0 % deviation.
4. When the reading is stable at the minimal, press **ZERO** to display zero

Model UT209: OPERATING MANUAL

5. Power on the tested conductor current, read out the reading after the Meter is stable.
6. This DC current measurement result is more accurate.

Note

- The Meter adopts relative value zeroing.
 - Press **ZERO** to display the present value as stored value and display zero. After that, all the measurement result displayed will automatically subtract the stored value.
 - Press **ZERO** again to display the stored value.
 - Press and hold **ZERO** to exit and back to normal operation.
- When measuring DC current, if the reading is positive, then the current direction is from up to down (see figure 9: the front case face up while the bottom case face down)
- When current measurement has been completed, disconnect the connection between the conductor under test and the jaw, and remove the conductor away from the transformer jaw of the Meter.

G. AC Current Measurement (see figure 9)

Warning

The operating temperature must be 0°C ~40°C when measuring current.

The measurement ranges of current are: 40A \sim and 1000A \sim .

1. Set the rotary switch to 40A \sim or 1000A \sim .
2. Hold the Meter tight, don't release. The Hall components are very sensitive not only to the magnet but also to heat and machines reaction force. Any shock will cause the changing in reading in the short time.
3. Press the lever to open the transformer jaw.
4. Center the conductor within the transformer jaw, then release the Meter slowly until the transformer jaw is completely closed, Make sure the conductor to be tested is placed at the center of

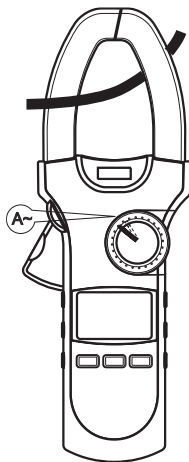

Figure 9

Model UT209: OPERATING MANUAL

the transformer jaw, otherwise it will cause deviation. The Meter can only measure one conductor at a time, to measure more than one conductor at a time will cause deviation.

5. When the measuring current $>1A$, press the **Hz** button to toggle between AC current and frequency measurement mode. But the frequency readings obtained from this range is only for reference.

Note

- When measuring AC current range, It may have unstable or wrong sensed readings, it will not affect measurement result.
- Change to AC:
Couple AC and True RMS response method. Input sine wave to adjust. Non sine wave must follow the below data to adjust:
Peak factor: 1.4~2.0, add 1.0% on the stated accuracy.
Peak factor: 2.0~2.5, add 2.5% on the stated accuracy
Peak factor: 2.5~3.0, add 4.0% on the stated accuracy.
- When current measurement has been completed, disconnect the connection between the conductor under test and the jaw, and remove the conductor away from the transformer jaw of the Meter.

Sleep Mode

To preserve battery life, the Meter automatically turns off if you do not turn the rotary switch or press any button for around 30 minutes.

The Meter beeps 3 times in one minute before entering Sleep Mode and one long beep just before entering Sleep Mode.

The Meter can be activated by turning the rotary switch or pressing the button except the ☀ button, details see the **‘The Effectiveness of Functional Buttons’** on page 11-12

If the Meter is activated by pressing button, the Meter will keep the measurement value before entering Sleep Mode.

Press **P**MAX/**P**MIN, **Z**ERO or \varnothing Hz to turn on the Meter can disable the Sleep Mode feature.

Specifications

A.General Specifications:

- 1 Maximum Voltage between any Terminals and grounding: Refer to different range input protection voltage.
- 1 Display: 3 3/4 digits LCD display, Maximum display 4000.
- 1 Polarity: Auto
- 1 Overloading: Display **OL** or **-OL**.
- 1 Battery Deficiency: Display .
- 1 Sampling: 3 times per second.
- 1 Measurement Deviation: The conductor being measured is not placed in the center of the jaw during AC/DC current measurement, it will cause extra $\pm 1\%$ deviation based on the stated accuracy.
- 1 Drop Test: 1 meter drop test passed.
- 1 Max. Jaw Size: 55mm diameter.
- 1 Projected Max. Current conductor size: 45mm diameter.
- 1 Electro-Magnetic: When carrying out measurement near the electro-magnetic, it may cause unstable or wrong reading.
- 1 Power: 1 x 9V battery (6LF22 1604A)

- 1 Battery Life: typically 150 hours (alkaline battery)
- 1 Dimensions: 285.3mm x 105mm x 44.5mm
- 1 Weight: Approximate 533g (battery included)

B. Environmental Requirements

- 1 The Meter is suitable for indoor use.
- 1 Altitude: Operating: 2000m
Storage: 10000m
- 1 Safety/ Compliances: IEC 61010 CAT.II 600V, CAT.III 300V
over voltage and double insulation standard, pollution degree 2.
- 1 Temperature and humidity:
 - Operating:
 - 0°C~30°C (≤80%R.H)
 - 30°C~40°C (≤75%R.H)
 - 40°C~50°C (≤45%R.H)
 - Storage:
 - 20°C~+60°C (≤80%R.H)

Accurate Specifications

Accuracy: \pm (a% reading + b digits), guarantee for 1 year.

Operating temperature: $23^{\circ}\text{C} \pm 5^{\circ}\text{C}$

Relative humidity: $\leq 85\% \text{R.H}$

Temperature coefficient: $0.1 \times (\text{specified accuracy}) / 1^{\circ}\text{C}$

A. DC Voltage

Range	Resolution	Accuracy	Overload protection
400mV	0.1mV	$\pm(0.8\%+3)$	600V DC/AC
4V	0.001V	$\pm(0.8\%+1)$	
40V	0.01V		
400V	0.1V		
600V	1V	$\pm(1\%+3)$	

Remark: Input Impedance: $10\text{M}\Omega$

B. AC Voltage

Range	Resolution	Accuracy	Overload protection
400mV	0.1mV	$\pm(1.2\%+20)$	600V DC/AC
4V	0.001V	$\pm(1.2\%+5)$	
40V	0.01V		
400V	0.1V		
600V	1V	$\pm(1.5\%+5)$	

Remarks:

- Input Impedance: 10M Ω
- Frequency Response:
 $\leq 400\text{mV}$ range: 50~100Hz
 Other ranges: 40Hz~400Hz
- Change to AC:
 Couple AC and True RMS response method. Input sine wave to adjust. Non sine wave must follow the below data to adjust:

Model UT209: OPERATING MANUAL

Peak factor: 1.4~2.0, add 1.0% on the stated accuracy

Peak factor: 2.0~2.5, add 2.5% on the stated accuracy

Peak factor: 2.5~3.0, add 4.0% on the stated accuracy.

C. Resistance

Range	Resolution	Accuracy	Overload protection
400Ω	0.1Ω	± (1.2%+2)	250VAC
4kΩ	1Ω	±(1%+2)	
40kΩ	10Ω		
400kΩ	100Ω		
4MΩ	1kΩ	±(1.2%+2)	
40MΩ	10kΩ	±(1.5%+2)	

D. Diode Test

Range	Resolution	Accuracy	Overload protection
	1mV	0.5V~0.8V (Open circuit voltage approx. 3.0V)	250VAC

E. Continuity Test

Range	Resolution	Accuracy	Overload protection
	0.1Ω	<ul style="list-style-type: none"> 1 The buzzer sounds if the resistance of a circuit under test is less than 30Ω. 1 The buzzer may or may not sound if the resistance of a circuit under test is between 30Ω to 100Ω. 1 The buzzer does not sound if the resistance of a circuit under test is higher than 100Ω Open circuit voltage approx. -1.2V 	250VAC

F. Frequency

Range	Resolution	Accuracy	Overload protection
4kHz	0.001kHz	± (0.1%+3)	250VAC
40kHz	0.01kHz		
400kHz	0.1kHz		
4MHz	0.001MHz		
40MHz	0.01MHz		

Remarks:

- 1 Input Sensitivity as follows:
When $\leq 100\text{kHz}$: $\geq 300\text{mV rms}$
When $> 100\text{kHz}$: $\geq 600\text{mV rms}$
- 1 Input amplitude a: $300\text{mV} \leq a \leq 30\text{V rms}$

G. DC Current

Range	Resolution	Accuracy	Overload protection
40A	0.01A	$\pm(2\%+40)$	250VAC
1000A	1A	$\pm(2\%+8)$	

H. AC Current

Range	Resolution	Accuracy	Overload protection
40A	0.01A	$\pm(2\%+40)$	250VAC
1000A	1A	$\pm(2\%+8)$	

MAINTENANCE

This section provides basic maintenance information including battery replacement instruction.



Warning

Do not attempt to repair or service your Meter unless you are qualified to do so and have the relevant calibration, performance test, and service information.

To avoid electrical shock or damage to the Meter, do not get water inside the case.

A. General Service

- Periodically wipe the case with a damp cloth and mild detergent. Do not use abrasives or solvents.
- To clean the terminals with cotton bar with detergent, as dirt or moisture in the terminals can affect readings.
- Turn the Meter power off when it is not in use.
- Take out the battery when it is not using for a long time.
- Do not use or store the Meter in a place of humidity, high temperature, explosive,

inflammable and strong magnetic field.

B. Replacing the Battery (see figure 10)

Warning

To avoid false readings, which could lead to possible electric shock or personal injury, replace the battery as soon as the battery indicator “” appears.

Make sure the transformer jaw and the tets leads are disconnected from the circuit being tested before opening the case bottom.

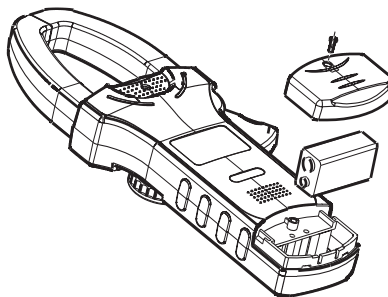

Figure 10

Model UT209: OPERATING MANUAL

To replace the battery:

1. Turn the Meter off and remove all the connections from the input terminals
2. Turn the Meter's front case down.
3. Remove the screw from the battery compartment, and separate the battery compartment from the case bottom.
4. Take out the old battery and replace with a new 9V battery (6LF22, 1604A).
5. Rejoin the case bottom and the battery compartment, and reinstall the screw.

*** END ***

This operating manual is subject to change without notice.

Model UT209: OPERATING MANUAL

©Copyright 2007 Uni-Trend Group Limited.
All rights reserved.

Manufacturer:

Uni-Trend Technology (Dongguan) Limited
Dong Fang Da Dao
Bei Shan Dong Fang Industrial Development District
Hu Men Town, Dongguan City Guang Dong Province
China
Postal Code: 523 925

Headquarters:

Uni-Trend Group Limited
Rm901, 9/F, Nanyang Plaza
57 Hung To Road Kwun Tong Kowloon, Hong Kong
Tel: (852) 2950 9168
Fax: (852) 2950 9303
Email: info@uni-trend.com
<http://www.uni-trend.com>