

## Contents

Title	Page
Overview .....	2
Unpacking Inspection .....	2
Safety Information .....	3
Rules for Safe Operation .....	4
International Electrical Symbols .....	6
The Meter Structure .....	7
Functional Buttons and auto power off .....	8
Display Symbols .....	10
Measurement Operation.....	11
A. DC Voltage Measurement.....	11
B. AC Voltage Measurement .....	12
C. Measuring Resistance .....	13
D. Testing Diodes .....	14
E. Testing for Continuity .....	15
F. AC Current Measurement.....	17
Specifications .....	19
A. General Specifications .....	19
B. Environmental Restriction .....	19
Accuracy Specifications .....	20
A. AC Voltage .....	20
B. DC Voltage.....	20
C. Resistance.....	21
D. Continuity Test.....	21
E. Diode Test.....	21
F. AC Current.....	22
Maintenance .....	23
A. General Service .....	23
B. Replacing the Battery .....	23

## Overview

This Operating Manual covers information on safety and cautions. Please read the relevant information carefully and observe all the Warnings and Notes strictly.

### Warning

To avoid electric shock or personal injury, read the “Safety Information” and “Rules for Safe Operation” carefully before using the Meter.

Digital Multimeter Model UT202A (hereafter referred to as “the Meter”) is 3 1/2 digits with steady operations, fashionable structure and highly reliable measuring instrument. The Meter uses large scale of integrated circuit with double integrated A/D converter as its core and has full range overload protection.

The Meter can measure AC/DC Voltage, AC Current, Resistance, Diodes, and Continuity.

## Unpacking Inspection

Open the package case and take out the Meter. Check the following items carefully to see any missing or damaged part:

Item	Description	Qty
1	English Operating Manual	1 piece
2	Test Lead	1 pair

In the event you find any missing or damage, please contact your dealer immediately.

## **Safety Information**

This Meter complies with the standards IEC61010: in pollution degree 2, overvoltage category (CATII 600V, CAT III 300V) and double insulation.

CATII: Local level, appliance, PORTABLE EQUIPMENT etc., with smaller transient overvoltages than CATIII.

CAT III: Distribution level, fixed installation, with smaller transient overvoltages than CAT IV

Use the Meter only as specified in this operating manual, otherwise the protection provided by the Meter may be impaired.

In this manual, a Warning identifies conditions and actions that pose hazards to the user, or may damage the Meter or the equipment under test.

A Note identifies the information that user should pay attention to.

International electrical symbols used on the Meter and in this Operating Manual are explained on page 6.

## Rules for Safe Operation

### Warning

To avoid possible electric shock or personal injury, and to avoid possible damage to the Meter or to the equipment under test, adhere to the following rules:

- Before using the Meter inspect the case. Do not use the Meter if it is damaged or the case (or part of the case) is removed. Look for cracks or missing plastic. Pay attention to the insulation around the connectors.
- Inspect the test leads for damaged insulation or exposed metal. Check the test leads for continuity. Replace damaged test leads with identical model number or electrical specifications before using the Meter.
- Do not apply more than the rated voltage, as marked on the Meter, between the terminals or between any terminal and grounding. If the value to be measured is unknown, use the maximum measurement position and reduce the range step by step until a satisfactory reading is obtained.
- When measurement has been completed, disconnect the connection between the test leads and the circuit under test, remove the testing leads away from the input terminals of the Meter and turn the Meter power off.
- The rotary switch should be placed in the right position and no any changeover of range shall be made during measurement is conducted to prevent damage of the Meter.
- Do not carry out the measurement when the Meter's back case and battery compartment











are not closed to avoid electric shock.

- Do not input higher than 600V between the Meter's terminals and the grounding to avoid electric shock and damages to the Meter.
- When the Meter working at an effective voltage over 60V in DC or 30V rms in AC, special care should be taken for there is danger of electric shock.
- Use the proper terminals, function, and range for your measurements.
- Do not use or store the Meter in an environment of high temperature, humidity, explosive, inflammable and strong magnetic field. The performance of the Meter may deteriorate after dampened.
- When using the test leads, keep your fingers behind the finger guards.
- Disconnect circuit power and discharge all high-voltage capacitors before testing resistance, continuity and diode.
- Replace the battery as soon as the battery indicator  appears. With a low battery, the Meter might produce false readings that can lead to electric shock and personal injury.
- When servicing the Meter, use only the same model number or identical electrical specifications replacement parts.
- The internal circuit of the Meter shall not be altered at will to avoid damage of the Meter and any accident.
- Soft cloth and mild detergent should be used to clean the surface of the Meter when servicing. No abrasive and solvent should be used to prevent the surface of the Meter from corrosion, damage and accident.
- The Meter is suitable for indoor use.
- Turn the Meter off when it is not in use and

take out the battery when not using for a long time.

- Constantly check the battery as it may leak when it has been using for some time, replace the battery as soon as leaking appears. A leaking battery will damage the Meter.

## International Electrical Symbols

	AC (Alternating Current)
	DC (Direct Current)
	AC or DC
	Grounding
	Double Insulated
	Warning. Refer to the Operating Manual
	Deficiency of Built-In Battery
	Continuity Test
	Diode
	Conforms to Standards of European Union

## The Meter Structure (see figure 1)

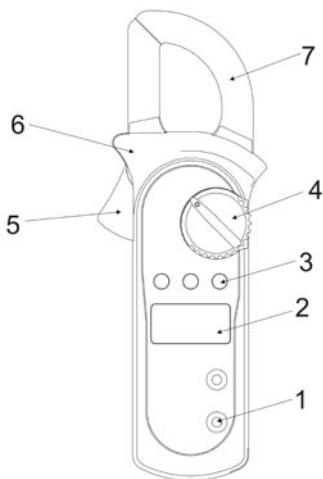

(figure 1)

1. Input Terminals
2. LCD Display
3. Functional Buttons
4. Rotary Switch
5. Trigger: press the lever to open the transformer jaws. When the pressure on the lever is released, the jaws will close.
6. Hand Guards: to protect user's hand from touching the dangerous area.
7. Transformer Jaws: designed to pick up the AC current flowing through the conductor. It could transfer current to voltage. The tested conductor must vertically go through the jaw center.

## Functional Buttons and auto power off

### 1. HOLD

Press **HOLD** to enter and exit hold mode. Press and hold **HOLD** button while turning on the Meter, auto power off be canceled.

### 2. MAX

Press **MAX** to start recording and updating of maximum values.

### 3. SELECT

Under  $\Omega \rightarrow \text{---} \rightarrow \text{---}$ ) ranging, resistance measurement mode is default, press **SELECT** to select continuity measurement mode or diode measurement mode.

### 4. Auto power off

To preserve battery life, the Meter automatically goes into a "sleep" mode if you do not press any button for around 10 minutes. The Meter can be activated by pressing any effective button (refer to The Effectiveness of Functional Buttons), then returns to the display for the function selected previously.

### 5. Buzzer

The buzzer phonate go with every time button be effectual pressed. When the meter will auto power off in 1 minute the buzzer beeps five times. Before power off there will be a long time buzzer beeps.

### 6. The Effectiveness of Functional Buttons

Not every functional buttons can be used on





## Display Symbols (see figure 2)

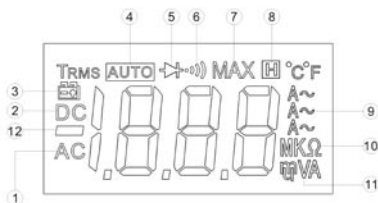

(figure 2)

Number	Meaning
1	Indicator for AC voltage or current
2	Indicator for DC voltage
3	The battery is low.  Warning: To avoid false readings, which could lead to possible electric shock or personal injury, replace the battery as soon as the battery indicator appears.
4	The Meter is in the auto range mode in which the Meter automatically selects the range with the best resolution.
5	Test of diode
6	The continuity buzzer is on
7	Maximum reading displayed
8	Data hold is active
9	Amperes (amps). The unit of current.
10	Ω: Ohm. The unit of resistance. kΩ:Kilohm. 1000 ohms MΩ:Megohm. 1,000,000 ohms
11	V: Volts. The unit of voltage. mV: Millivolt. 0.001 volts
12	Indicates negative reading

## Measurement Operation

### A. DC Voltage Measurement (see figure 3)

#### Warning

To avoid harms to you or damages to the Meter from electric shock, do not attempt to measure voltages higher than 600V AC/DC.

To measure DC voltage, connect the Meter as follows:

1. Insert the red test lead into the **VΩ→** terminal and the black test lead into the **COM** terminal.
2. Set the rotary switch to **V $\overline{\text{=}}$** .
3. Connect the test leads across with the object being measured.

The measured value shows on the display.

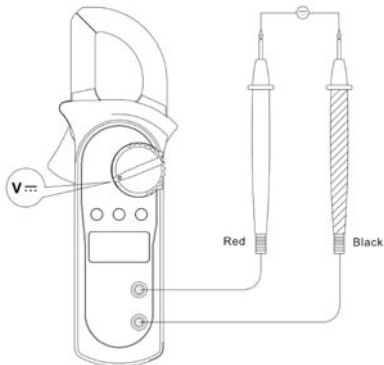

(figure 3)

**Note:**

When DC voltage measurement has been completed, disconnect the connection between the testing leads and the circuit under test and remove testing leads from the input terminals.

**B. AC Voltage Measurement** (see figure 4)**⚠ Warning**

To avoid harms to you or damages to the Meter from electric shock, do not attempt to measure voltages higher than 600V AC/DC.

To measure AC voltage, connect the Meter as follows:

1. Insert the red test lead into the **VΩ→** terminal and the black test lead into the **COM** terminal.
2. Set the rotary switch to **V~**.
3. Connect the test leads across with the object being measured.

The measured value shows on the display.

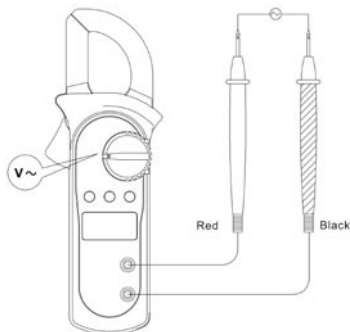

(figure 4)

**Note:**

When AC voltage measurement has been completed, disconnect the connection between the testing leads and the circuit under test and remove testing leads from the input terminals.

**C. Measuring Resistance** (see figure 5) **Warning**

To avoid damages to the Meter or to the devices under test, disconnect circuit power and discharge all the high-voltage capacitors before measuring resistance.

To measure resistance, connect the Meter as follows:

1. Insert the red test lead into the **V $\Omega$**  terminal and the black test lead into the **COM** terminal.
2. Set the rotary switch to  **$\Omega$** ; resistance measurement ( $\Omega$ ) is default or press **SELECT** button to select  **$\Omega$**  measurement mode
3. Connect the test leads across with the object being measured.

The measured value shows on the display.

**Note:**

- To remove the objects being tested from the circuit when measuring can obtain a more accurate result.
- When resistance measurement has been completed, disconnect the connection between the testing leads and the circuit under test and remove testing leads from the input terminals.

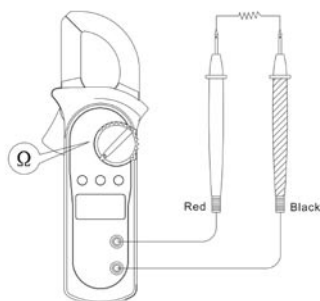

(figure 5)

#### D. Testing Diodes (see figure 6)



##### Warning

To avoid damages to the Meter or to the devices under test, disconnect circuit power and discharge all the high-voltage capacitors before testing diodes.

To test the diode out of a circuit, connect the Meter as follows:

1. Insert the red test lead into the **VΩ** terminal and the black test lead into the **COM** terminal.
2. Set the rotary switch to **Ω** and press **SELECT** button to select measurement mode.
3. For forward voltage drop readings on any semiconductor component, place the red test lead on the component's anode and place the black test lead on the component's cathode.

**Note:**

- To remove the objects being tested from the circuit when measuring can obtain a more accurate result.
- When diode testing has been completed, disconnect the connection between the testing leads and the circuit under test and remove testing leads from the input terminals.

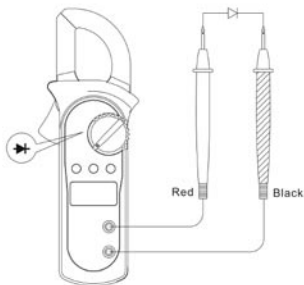

(figure 6)

**E. Testing for Continuity** (see figure 7)

**⚠ Warning**

To avoid damages to the Meter or to the devices under test, disconnect circuit power and discharge all the high-voltage capacitors before measuring continuity.

To test for continuity, connect the Meter as follows:

1. Insert the red test lead into the **VΩ→H→)** terminal and the black test lead into the **COM** terminal.

2. Set the rotary switch to  $\Omega \rightarrow \rightarrow \rightarrow$ ) and press **SELECT** button to select  $\rightarrow \rightarrow$ ) measurement mode.
3. The buzzer sounds if the resistance of a circuit under test is less than  $10\Omega$ .
4. The buzzer may or may not sounds if the resistance of a circuit under test is more than  $10\Omega$ .

**Note:**

When continuity testing has been completed, disconnect the connection between the testing leads and the circuit under test and remove testing leads from the input terminals.

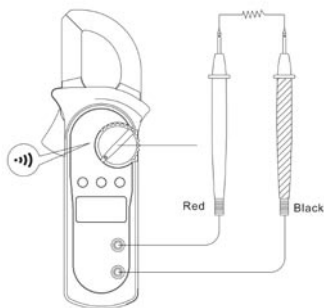

(figure 7)



**F. AC Current Measurement** (see figure 8) **Warning**

To avoid electric shock, never measure current while the test leads are inserted into the input terminals and disconnect test leads and tested circuit connection.

Never attempt an in-circuit current measurement where the open-circuit voltage between the circuit and the ground is greater than 600V

User proper function, and range for the measurement.

To measure current, do the following:

1. Set the rotary switch to 20A $\sim$ , 200 A $\sim$  or 600 A $\sim$ .
2. Press the lever to open the transformer jaws.
3. Center the conductor within the transformer jaw, then release the Meter slowly until the transformer jaw is completely closed, Make sure the conductor to be tested is placed at the center of the transformer jaw, otherwise it will cause deviation. The Meter can only measure one conductor at a time, to measure more than one conductor at a time will cause deviation.

**Note:**

When current measurement has been completed, disconnect the connection between the conductor under test and the jaw, and remove the conductor away from the transformer jaw of the Meter.

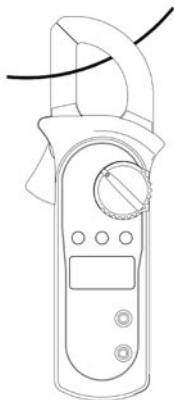

(figure 8)

## Specifications

### A. General Specifications

- Display: 3 1/2 digits LCD display, Maximum display 1999
- Auto Polarity Display
- Overloading: Display **OL** or **-OL**
- Battery Deficiency: Display 
- Measurement Speed: Updates 3 times/second.
- Measurement Deviation: When the conductor being measured is not placed in a correct position during AC current measurement, it will cause  $\pm 3\%$  reading deviation.
- Drop Test: 1 meter drop test passed
- Max. Jaw Size: 28mm diameter
- Projected Max. Current conductor size: 26mm diameter.
- Power: 9V battery
- Sleep Mode (can be disabled)
- Dimensions: 76mm x 208mm x 30mm.
- Weight: Approximate 260g (battery included)

### B. Environmental Restrictions

- The Meter is suitable for indoor use.
- Altitude: Operating: 2000m  
Storage: 10000m
- Safety/ Compliances: IEC 61010 CATII 600V, CATIII 300V over voltage and double insulation standard.
- Pollution degree: 2
- Temperature and humidity:
  - Operating:  $0^{\circ}\text{C}\sim 30^{\circ}\text{C}$  ( $\leq 75\%\text{R.H}$ );
  - $30^{\circ}\text{C}\sim 40^{\circ}\text{C}$  ( $\leq 70\%\text{R.H}$ );
  - $40^{\circ}\text{C}\sim 50^{\circ}\text{C}$  ( $\leq 45\%\text{R.H}$ );
  - Storage:  $-20^{\circ}\text{C}\sim +60^{\circ}\text{C}$  ( $\leq 75\%\text{R.H}$ )

## Accurate Specifications

Accuracy:  $\pm(a\% \text{ reading} + b \text{ digits})$ , guarantee for 1 year.

Operating temperature:  $23^{\circ}\text{C} \pm 5^{\circ}\text{C}$

Relative humidity:  $\leq 75\% \text{R.H}$

Temperature coefficient:  $0.1 \times (\text{specified accuracy}) / 1^{\circ}\text{C}$

### A. AC Voltage: Auto ranging

Range	Resolution	Accuracy
2.000V	1mV	$\pm(1.2\%+5)$
20.00V	10mV	
200.0V	100mV	
600V	1V	$\pm(1.5\%+5)$

Remarks:

- Overload protection: 600V rms
- Input impedance:  $10\text{M}\Omega // <100\text{pF}$
- Displays effective value of sine wave (mean value response).
- Frequency response: 40Hz~1kHz.

### B. DC Voltage: Auto ranging

Range	Resolution	Accuracy
200.0mV	0.1mV	$\pm(0.8\%+3)$
2.000V	1mV	$\pm(0.8\%+1)$
20.00V	10mV	
200.0V	100mV	
600V	1V	$\pm(1\%+3)$

Remarks:

- Input impedance:  $10\text{M}\Omega$
- Overload protection: 600V rms

**C. Resistance: Auto ranging**

Range	Resolution	Accuracy
200.0Ω	100mΩ	±(1.2%+2)
2.000kΩ	1Ω	±(1%+2)
20.00kΩ	10Ω	
200.0kΩ	100Ω	
2.000MΩ	1kΩ	±(1.2%+2)
20.00MΩ	10kΩ	±(1.5%+2)

Remark:

- Overload protection: 600Vp

**D. Continuity Test**

Range	Resolution	Accuracy
	100mΩ	Around $\leq 10\Omega$ , the buzzer beeps.

Remark:

- Overload Protection: 600Vp
- Open circuit voltage approximate 0.45V.
- The buzzer may or may not beeps when the resistance of a circuit under test is more than 10Ω.

**E. Diode Test**

Range	Resolution	Accuracy
	1mV	Display approximate forward voltage drop

Remarks:

- Overload Protection: 600Vp
- Open circuit voltage approximate 1.48V.

**F. AC Current: Auto ranging**

Range	Resolution	Accuracy
20.00A	0.01A	$\pm(2.0\%+5)$
200.0A	0.1A	$\pm(1.5\%+5)$
600A	1A	$\pm(2.0\%+8)$

Remarks:

- Overload protection: 600A rms
- Frequency Response: 50Hz~60Hz
- Displays effective value of sine wave (mean value response).
- To adjust reading in accordance with effective value.

## Maintenance

This section provides basic maintenance information including battery replacement instruction.

 **Warning**

Do not attempt to repair or service your Meter unless you are qualified to do so and have the relevant calibration, performance test, and service information.

To avoid electrical shock or damage to the Meter, do not get water inside the case.

### A. General Service

- Periodically wipe the case with a damp cloth and mild detergent. Do not use abrasives or solvents.
- To clean the terminals with cotton bar with detergent, as dirt or moisture in the terminals can affect readings.
- Turn the Meter power off when it is not in use.
- Take out the battery when it is not using for a long time.
- Do not use or store the Meter in a place of humidity, high temperature, explosive, inflammable and strong magnetic field.

### B. Replacing the Battery (see figure 9)

 **Warning**

To avoid false readings, which could lead to possible electric shock or personal injury,

replace the battery as soon as the battery indicator “” appears.

Make sure the transformer jaw and the tets leads are disconnected from the circuit being tested before opening the case bottom.

To replace the battery:

1. Turn the Meter off and remove all the connections from the input terminals.
2. Turn the Meter's case top down.
3. Remove the screw from the battery compartment, and separate the battery compartment from the case bottom.
4. Remove the old battery from the battery compartment.
5. Rejoin the case bottom and the battery compartment, and reinstall the screw.

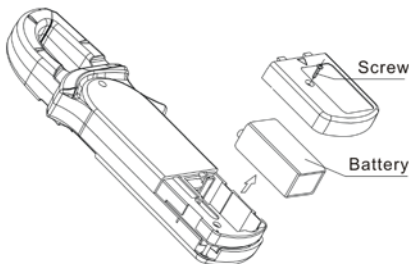

(figure 9)

The content is subject to change without prior notice



©Copyright 2009 Uni-Trend Group Limited.  
All rights reserved.

**Manufacturer:**

Uni-Trend Technology (Dongguan) Limited  
Dong Fang Da Dao  
Bei Shan Dong Fang Industrial Development District  
Hu Men Town, Dongguan City  
Guang Dong Province  
China

Postal Code: 523 925

**Headquarters:**

Uni-Trend Group Limited  
Rm901, 9/F, Nanyang Plaza  
57 Hung To Road  
Kwun Tong  
Kowloon, Hong Kong  
Tel: (852) 2950 9168  
Fax: (852) 2950 9303  
Email: [info@uni-trend.com](mailto:info@uni-trend.com)  
<http://www.uni-trend.com>