



Datasheet

Part No:
TG.59.0113

Description:

1.4-6GHz High-Band 5G Terminal Monopole Antenna
With Hinged SMA Male Connector

Features:

5G NR High-Band (1.4-6GHz)
Monopole Antenna Design
90° Rotatable Hinge Design for Optimal Positioning
Dimensions: 72 x Ø10 mm when fully extended
CE Certified for RoHS Compliance
REACH Compliant



1. Introduction	3
2. Specifications	4
3. Antenna Characteristics	7
4. Radiation Patterns	10
5. Mechanical Drawing	35
6. Installation Recommendations	36
7. Packaging	37
Changelog	38

Taoglas makes no warranties based on the accuracy or completeness of the contents of this document and reserves the right to make changes to specifications and product descriptions at any time without notice. Taoglas reserves all rights to this document and the information contained herein. Reproduction, use or disclosure to third parties without express permission is strictly prohibited.



1. Introduction



The Taoglas TG.59 is a 5G High-band Terminal Mount Antenna. It is one of the smallest high band terminal mount antennas on the market and covers all new worldwide 5G bands between 1400 - 6000MHz as well as legacy 4G/3G bands. Compared to other much larger antennas on the market, it has superior wide-band efficiency characteristics over worldwide 5G/4G higher frequency bands, reaching up to 84% on some bands. The TG.59 is also compatible with most 5G Sub 6GHz cellular bands between 3500-3800MHz and is an Omni-directional antenna that exhibits a uniform 360° radiation pattern on all bands.

The unique rotatable hinge design enables the user to rotate the antenna to the best angle to optimize cellular signal reception. The upper antenna element can rotate in any direction, making it resistant to damage from impact forces, compared to a traditional right angle or fixed angle designs. The small form factor of this antenna, coupled with excellent RF performance and an aesthetic high-end design, make it the ideal cellular antenna choice for typical applications include:

- Gateways, Routers, and Wireless Access Points
- Smart & Connected Home
- Transportation & Telematics
- Telemedicine Devices
- Digital Signage and POS Terminals.
- AR/VR Headsets and Devices

The TG.59, as do all monopole antennas, works best when connected directly to the ground-plane of the device's main-board. Ideally, it should be directly connected to ground-planes with dimensions greater than 90mm*150mm. Taoglas offers support services to characterize antenna efficiency on your individual device ground-plane.

Contact your regional Taoglas customer support team if you wish to conduct PTCRB or network approvals with this antenna attached to your device. Taoglas can check that the RF integration is correct, and we can also conduct pre-tests to ensure optimized passive and active performance and a smooth and quick certification approval process.

2. Specifications

Electrical									
Band	Frequency (MHz)	Test Setup	Efficiency (%)	Average Gain (dB)	Peak Gain (dBi)	Impedance	Max Input Power	Polarization	Radiation Pattern
5G/4G Band 11,21,32,74,75,76	1400~1520	Bent Free Space	83	-0.81	3.27	50 Ω	2W	Linear	Omni
		Straight Free Space	84.7	-0.72	3.31				
		Bent Ground Plane	69.8	-1.56	2.38				
		Straight Ground Plane	69.7	-1.57	2.55				
4G/3G Band 1,2,3,4,9,23,25,35,39,66	1710~2200	Bent Free Space	72.9	-1.37	4.48				
		Straight Free Space	71.5	-1.46	4.30				
		Bent Ground Plane	69.3	-1.59	3.90				
		Straight Ground Plane	67.9	-1.68	4.02				
4G/3G Band 7,30,38,40,41	2300~2690	Bent Free Space	54.1	-2.67	3.59				
		Straight Free Space	52.3	-2.82	3.37				
		Bent Ground Plane	51.9	-2.85	2.82				
		Straight Ground Plane	50.3	-2.99	2.82				
5G/4G Band 22,42,78	3300~3800	Bent Free Space	68.5	-1.64	5.38				
		Straight Free Space	68.8	-1.62	5.22				
		Bent Ground Plane	46.5	-3.33	3.61				
		Straight Ground Plane	49.3	-3.07	3.98				
5G/4G Band 22,42,43,48,77,78,79	3200~5000	Bent Free Space	69.2	-1.6	5.42				
		Straight Free Space	70.1	-1.62	4.64				
		Bent Ground Plane	49.9	-3.04	4.08				
		Straight Ground Plane	50	-3.02	3.87				
Greater than 5GHz	5150~5925	Bent Free Space	54.9	-2.61	2.73				
		Straight Free Space	46.3	-3.35	1.47				
		Bent Ground Plane	49.3	-3.07	1.97				
		Straight Ground Plane	39.4	-4.05	0.34				

*Results based of a Ground Plane size of 150*90mm

Mechanical	
Antenna Length	72mm
Antenna Diameter	10mm
Casing	ABS
Connector	SMA Male Hinged
Weight	8g
Environmental	
Temperature Range	-40°C to 80°C
Humidity	Non-condensing 65°C 95% RH

5G/4G Bands			
Band Number	5G NR / FR1 / LTE / LTE-Advanced / WCDMA / HSPA / HSPA+ / TD-SCDMA		
	Uplink	Downlink	Covered
1	UL: 1920 to 1980	DL: 2110 to 2170	✓
2	UL: 1850 to 1910	DL: 1930 to 1990	✓
3	UL: 1710 to 1785	DL: 1805 to 1880	✓
4	UL: 1710 to 1755	DL: 2110 to 2155	✓
5	UL: 824 to 849	DL: 869 to 894	✗
7	UL: 2500 to 2570	DL: 2620 to 2690	✓
8	UL: 880 to 915	DL: 925 to 960	✗
9	UL: 1749.9 to 1784.9	DL: 1844.9 to 1879.9	✓
11	UL: 1427.9 to 1447.9	DL: 1475.9 to 1495.9	✓
12	UL: 699 to 716	DL: 729 to 746	✗
13	UL: 777 to 787	DL: 746 to 756	✗
14	UL: 788 to 798	DL: 758 to 768	✗
17	UL: 704 to 716	DL: 734 to 746	✗
18	UL: 815 to 830	DL: 860 to 875	✗
19	UL: 830 to 845	DL: 875 to 890	✗
20	UL: 832 to 862	DL: 791 to 821	✗
21	UL: 1447.9 to 1462.9	DL: 1495.9 to 1510.9	✓
22	UL: 3410 to 3490	DL: 3510 to 3590	✓
23	UL: 2000 to 2020	DL: 2180 to 2200	✓
24	UL: 1625.5 to 1660.5	DL: 1525 to 1559	✓
25	UL: 1850 to 1915	DL: 1930 to 1995	✓
26	UL: 814 to 849	DL: 859 to 894	✗
27	UL: 807 to 824	DL: 852 to 869	✗
28	UL: 703 to 748	DL: 758 to 803	✗
29	UL: -	DL: 717 to 728	✗
30	UL: 2305 to 2315	DL: 2350 to 2360	✓
31	UL: 452.5 to 457.5	DL: 462.5 to 467.5	✗
32	UL: -	DL: 1452 - 1496	✓
35		1850 to 1910	✓
38		2570 to 2620	✓
39		1880 to 1920	✓
40		2300 to 2400	✓
41		2496 to 2690	✓
42		3400 to 3600	✓
43		3600 to 3800	✓
48		3550 to 3700	✓
66	UL: 1710-1780	DL: 2110-2200	✓
71		617 to 698	✗
74/75/76		1427 to 1518	✓
78		3300 to 3800	✓
79		4400 to 5000	✓
126		410 to 430	✗

*Covered bands represent greater than 20% efficiency

3. Antenna Characteristics

3.1 Return Loss

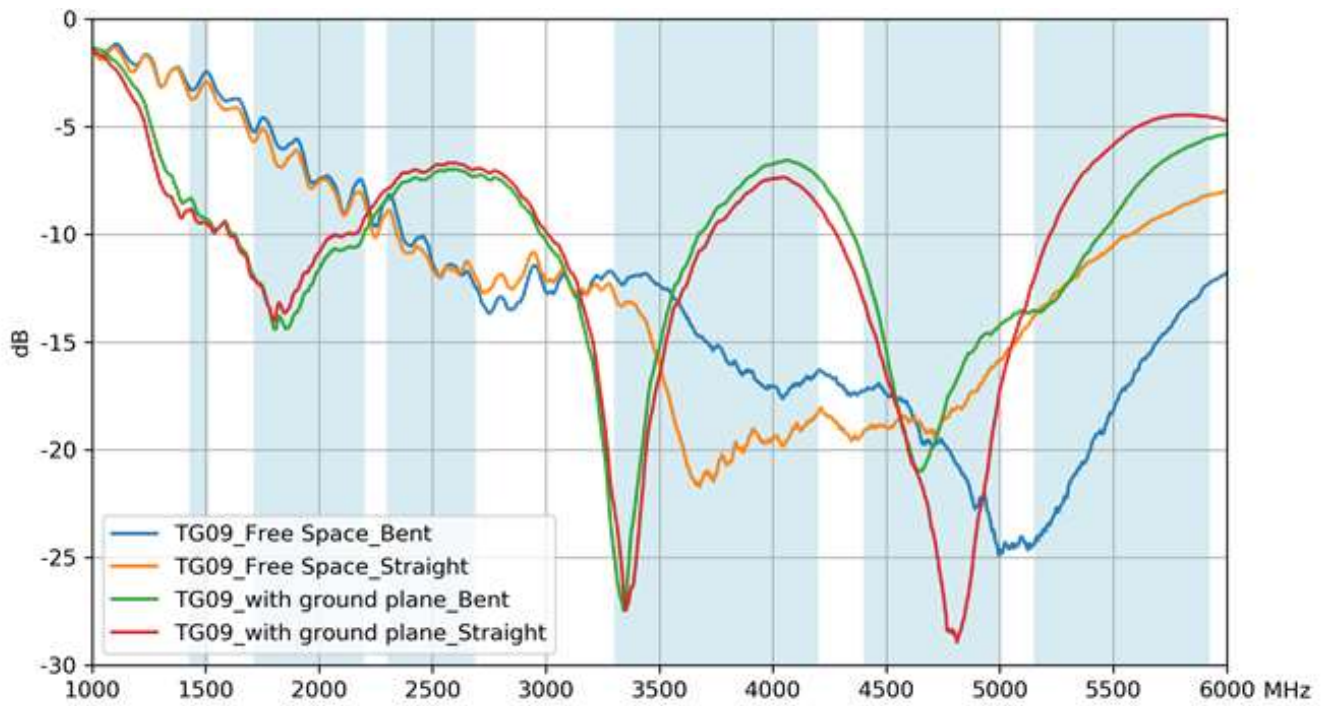

3.2 VSWR

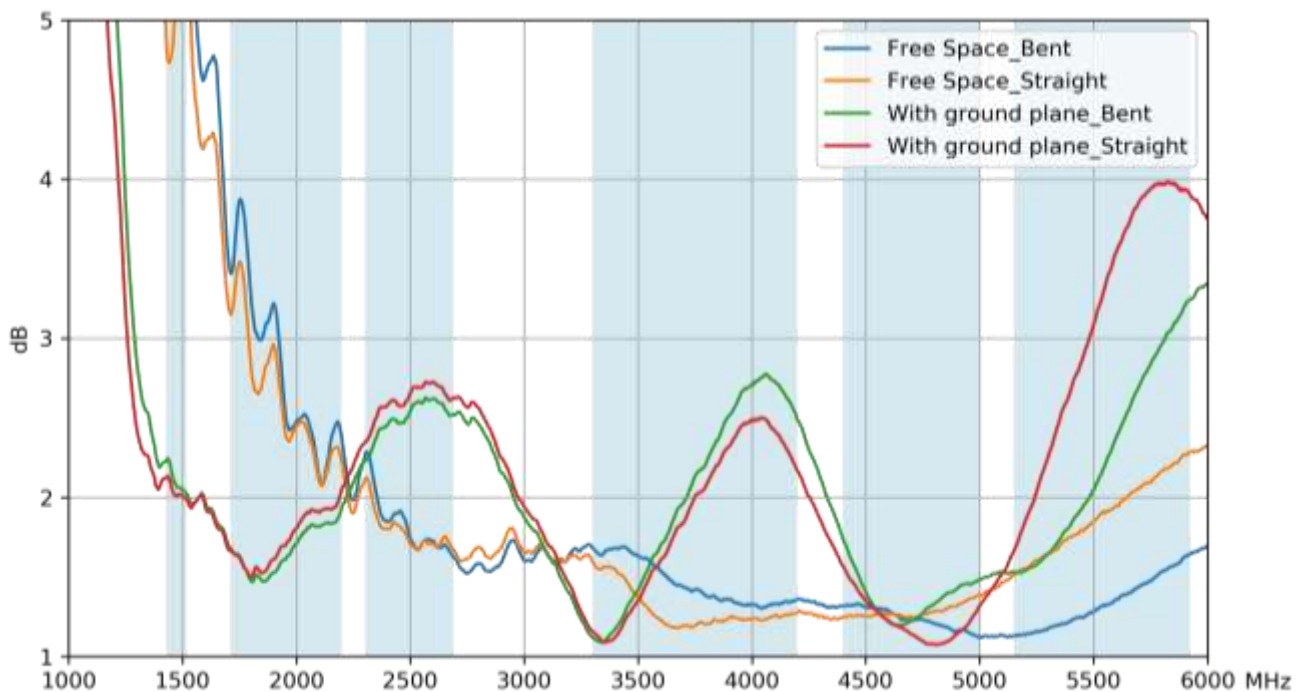

3.3 Efficiency

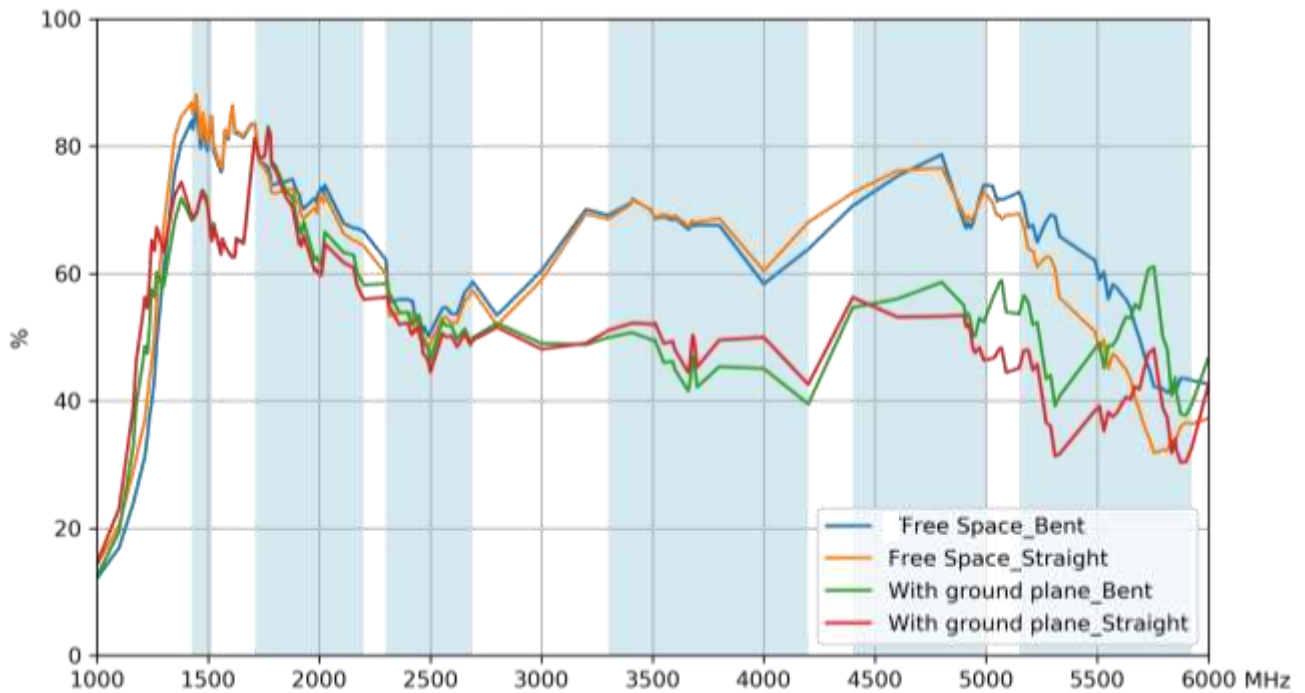

3.4 Peak Gain

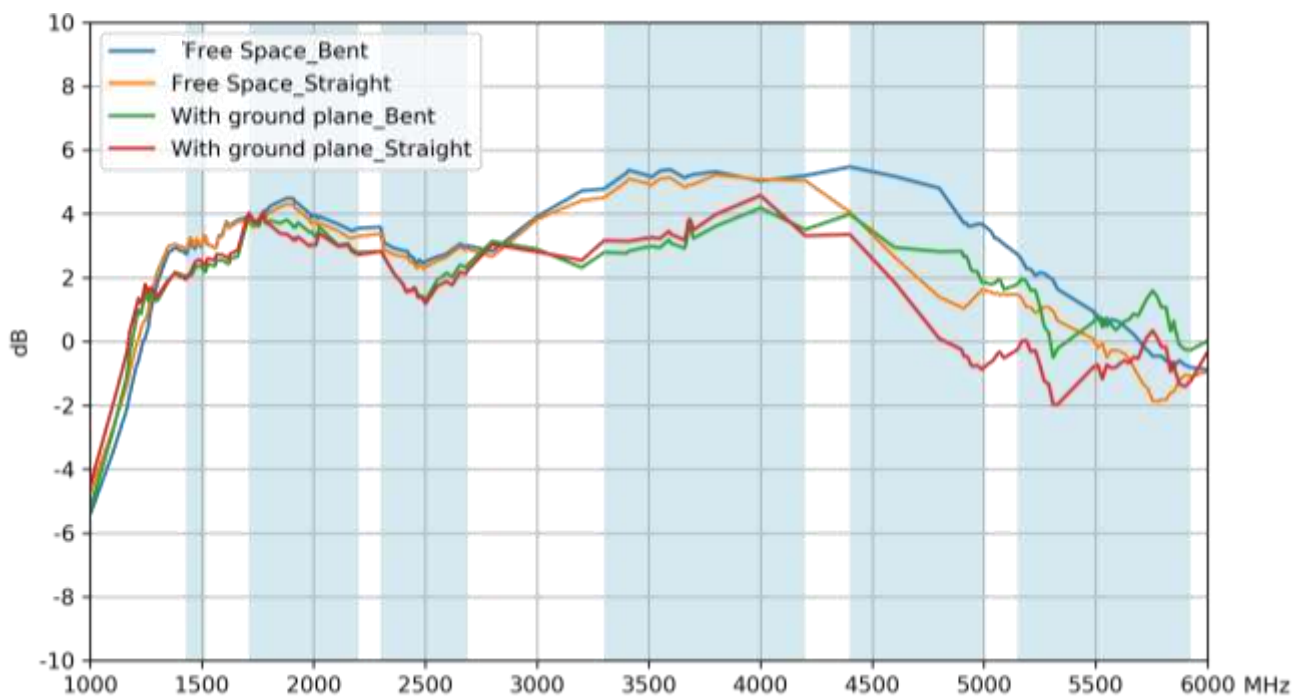

3.5 Average Gain

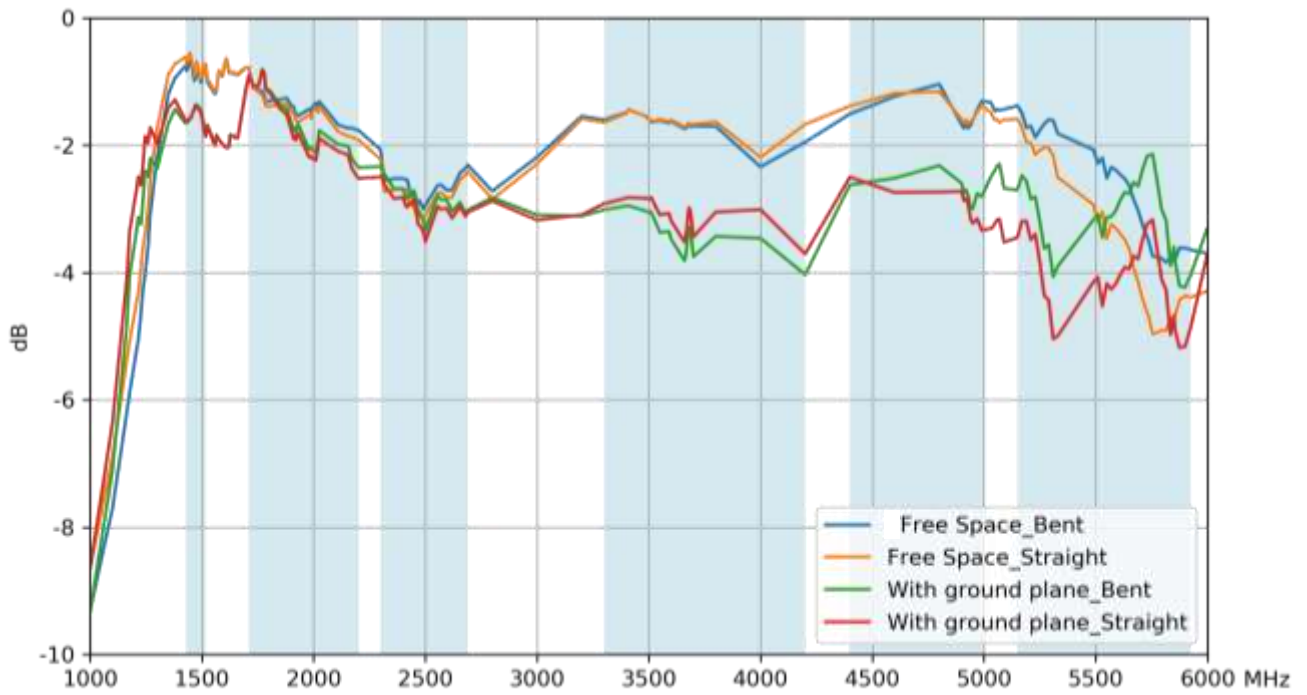

4. Radiation Patterns

4.1 Test Setup



4.2 3D and 2D Radiation Patterns – Free Space Bent

1930MHz

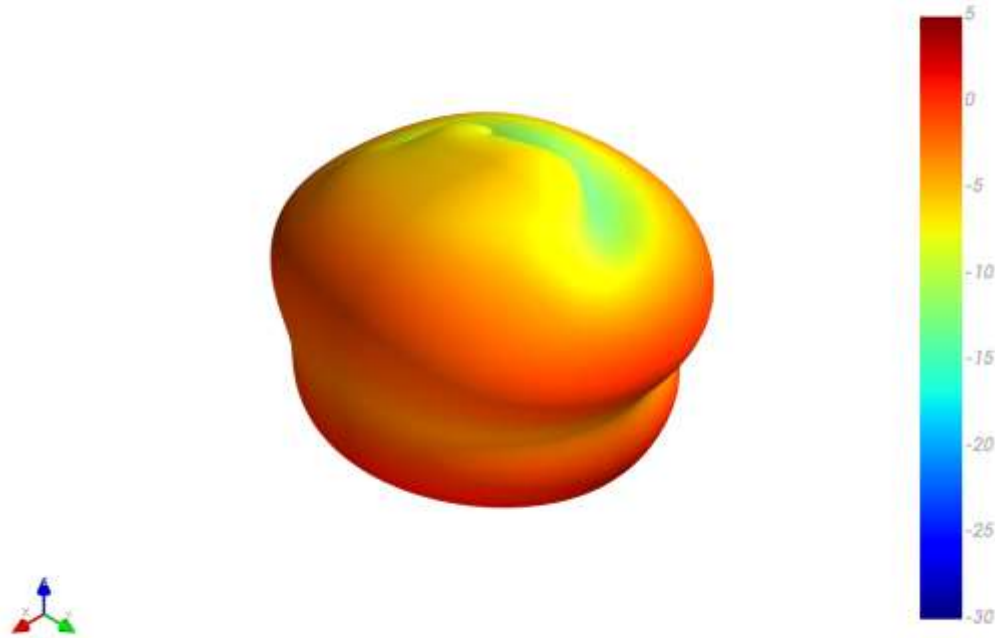

XY Plane

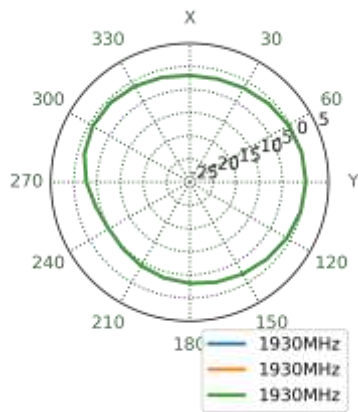

XZ Plane

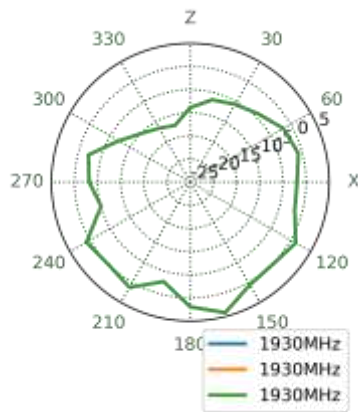

YZ Plane

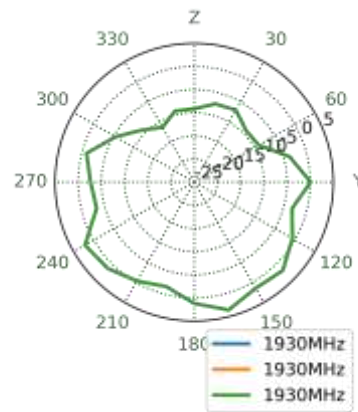

2496MHz

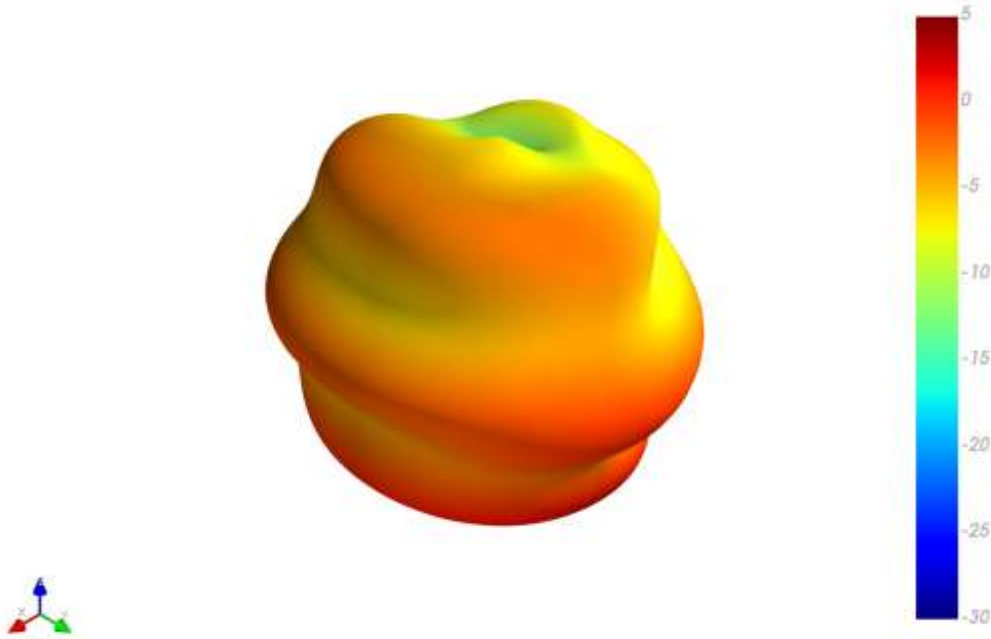

XY Plane

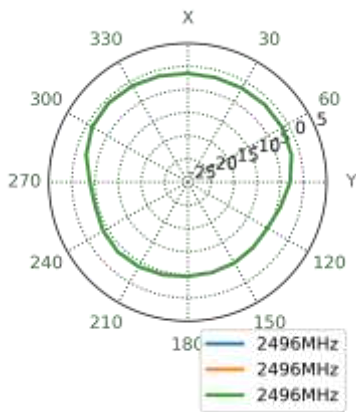

XZ Plane

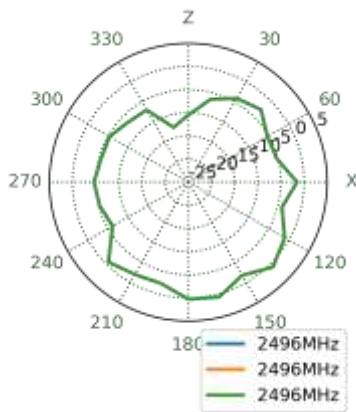

YZ Plane

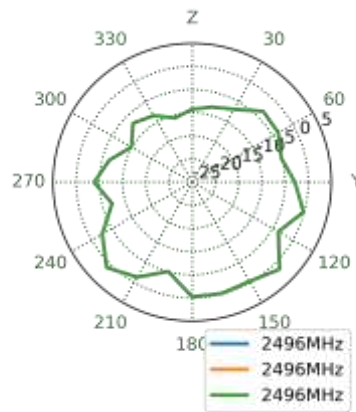

3550MHz

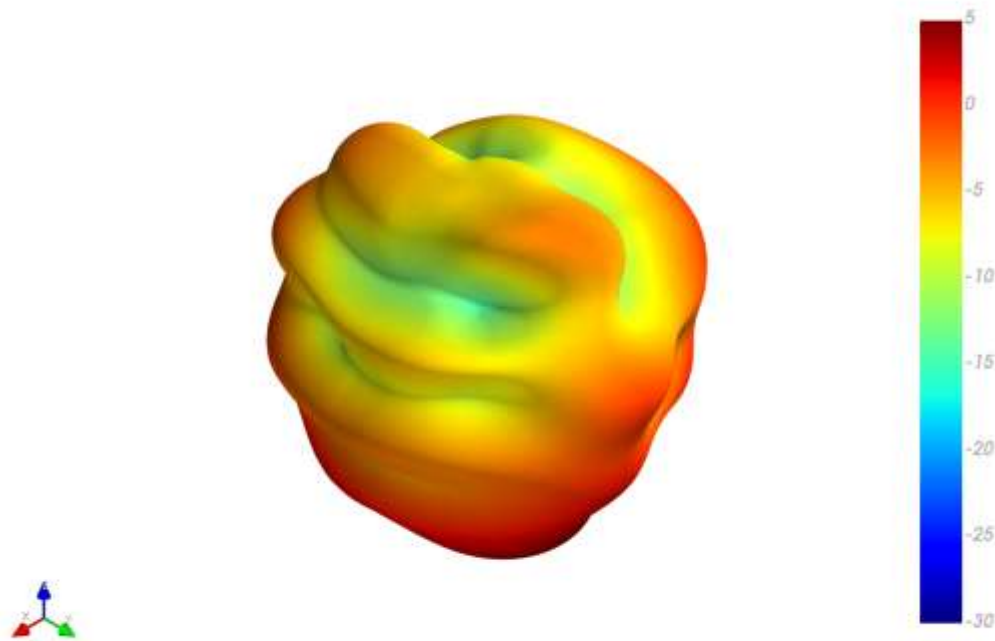

XY Plane

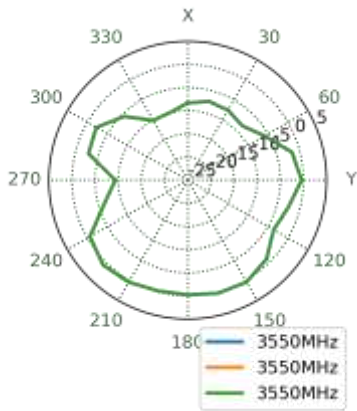

XZ Plane

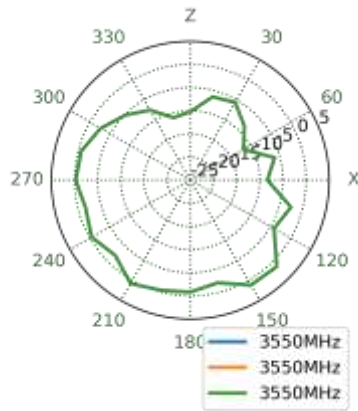

YZ Plane

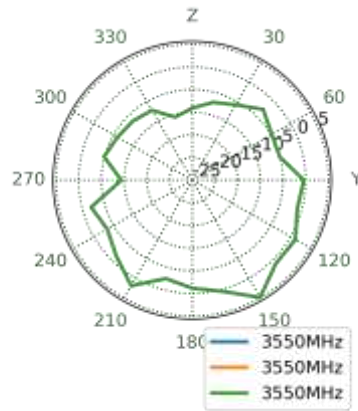

3700MHz

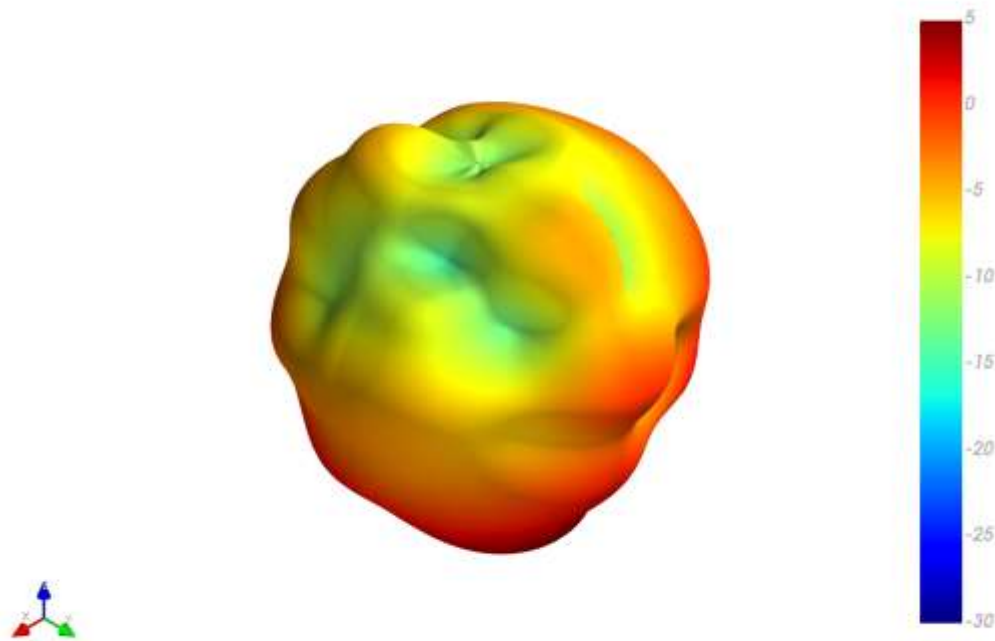

XY Plane

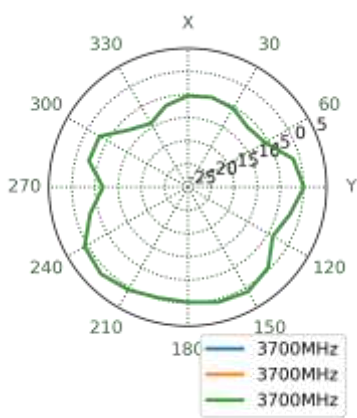

XZ Plane

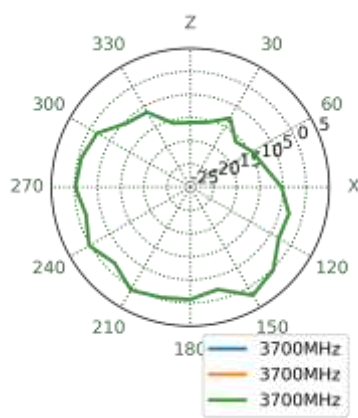

YZ Plane

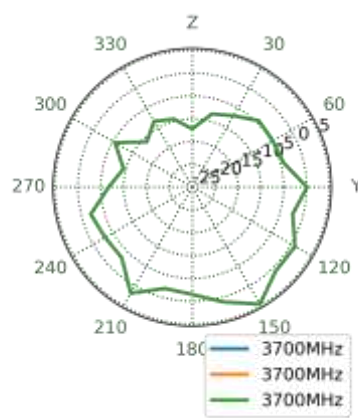

4800MHz

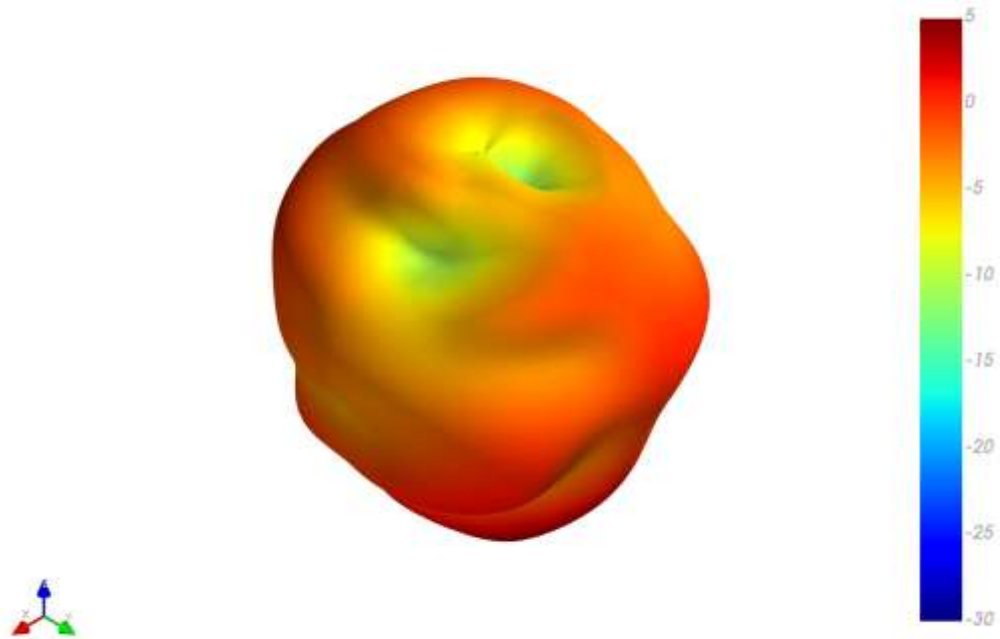

XY Plane

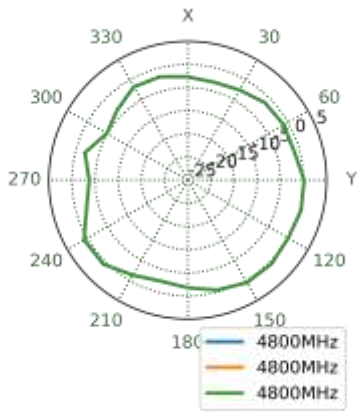

XZ Plane

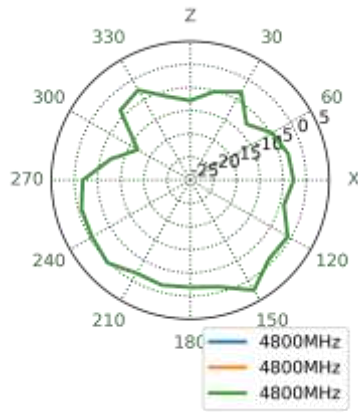

YZ Plane

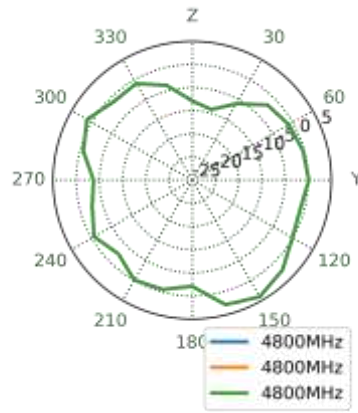

5550MHz

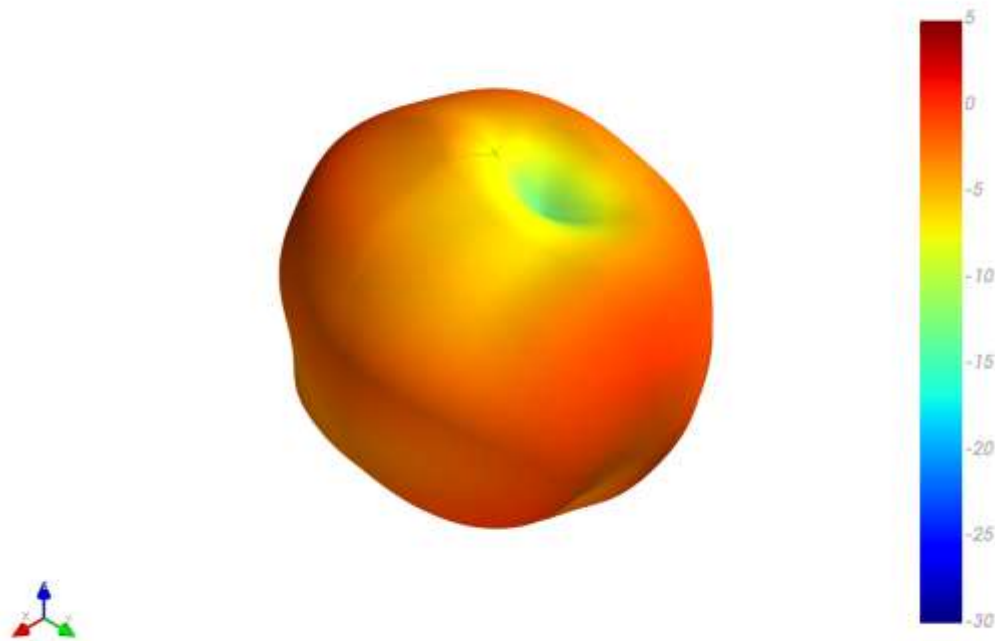

XY Plane

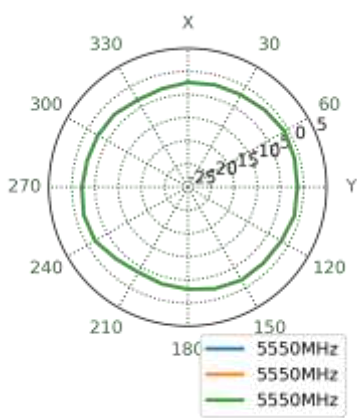

XZ Plane

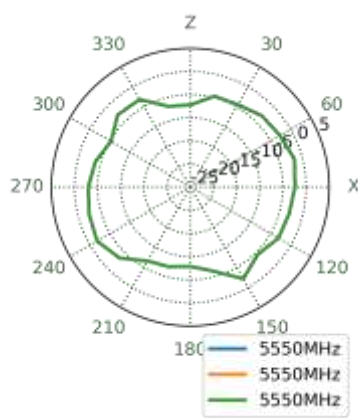

YZ Plane

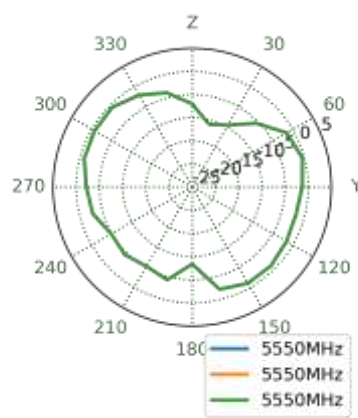

4.3 3D and 2D Radiation Patterns – Free Space Straight

1930MHz

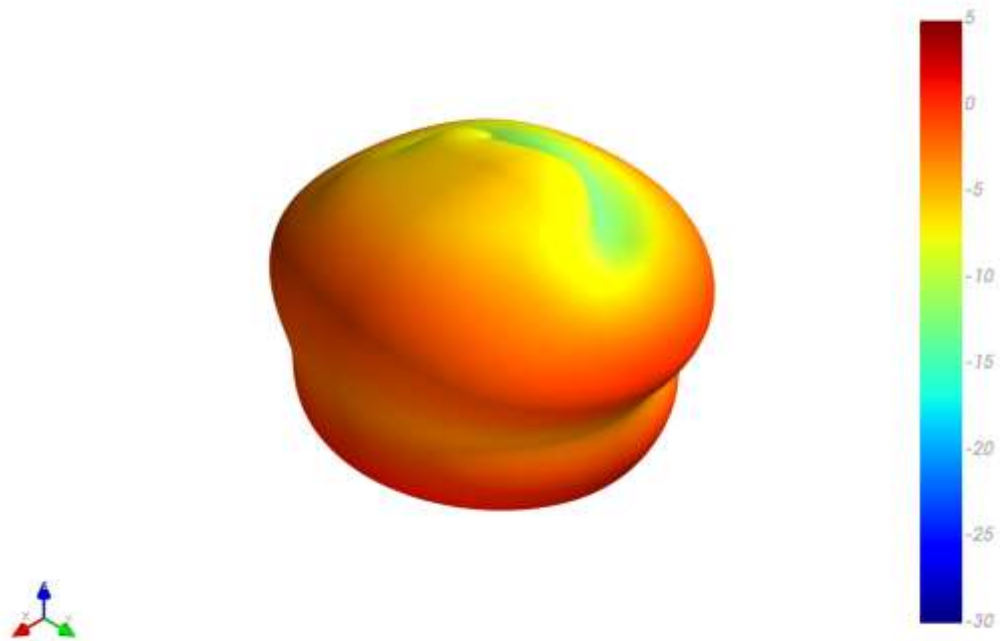

XY Plane

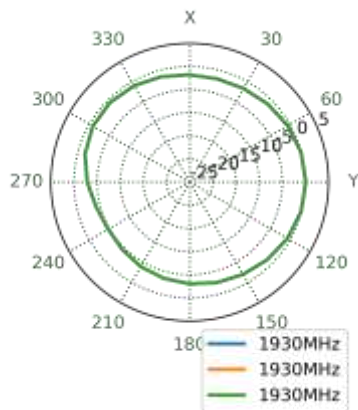

XZ Plane

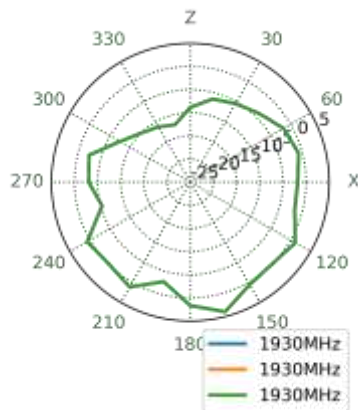

YZ Plane

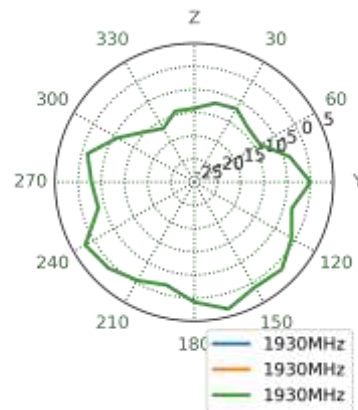

2496MHz

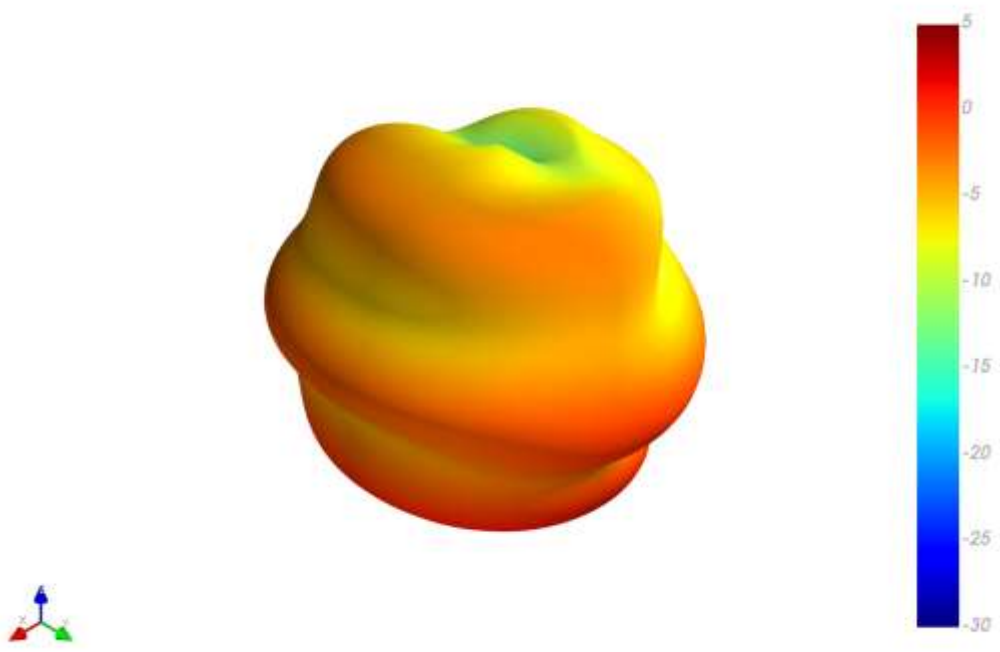

XY Plane

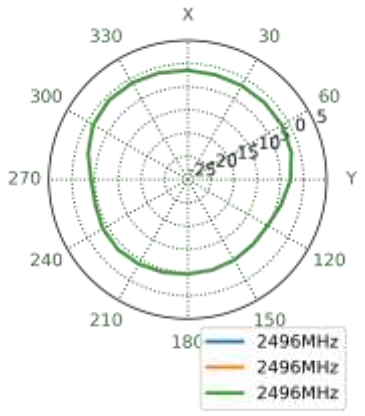

XZ Plane

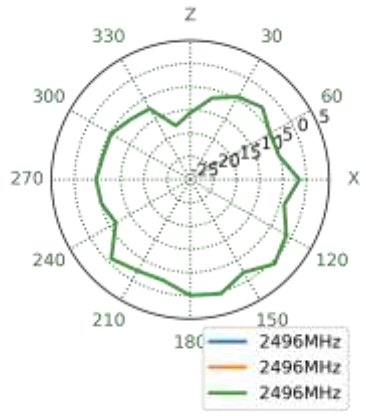

YZ Plane

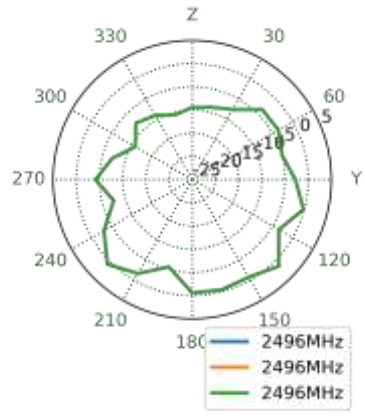

3550MHz

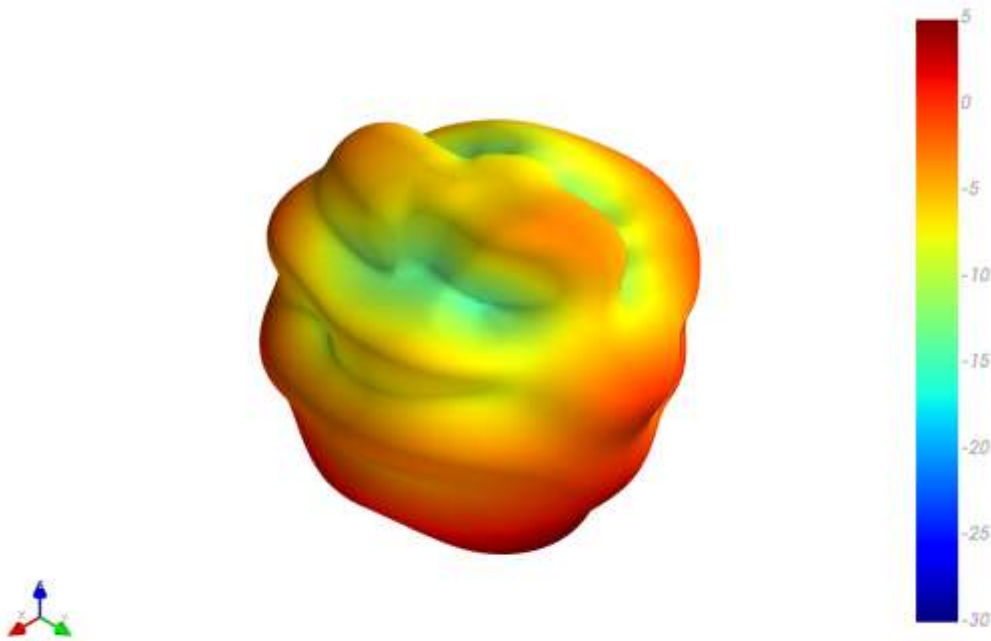

XY Plane

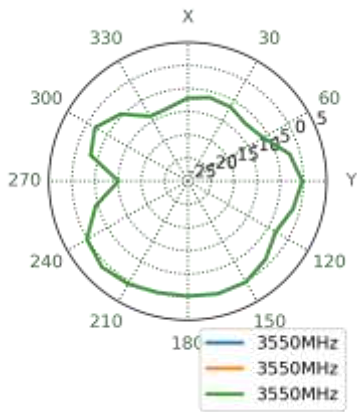

XZ Plane

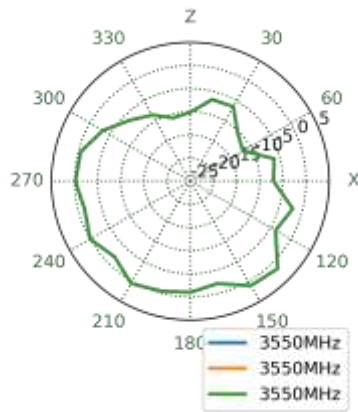

YZ Plane

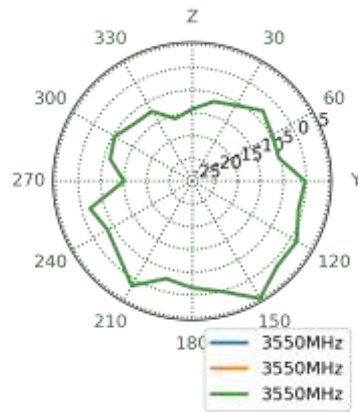

3700MHz

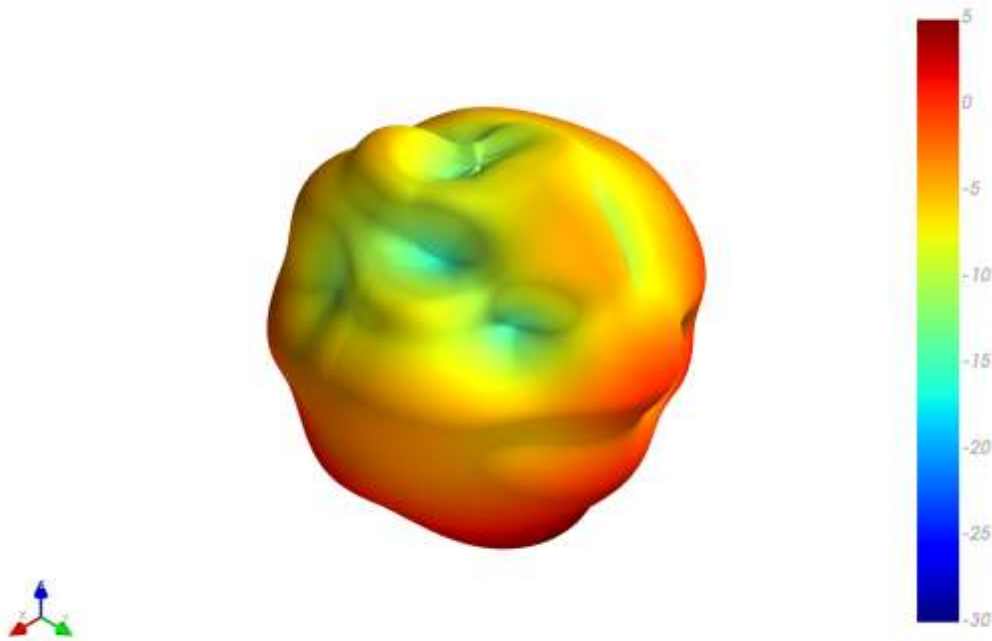

XY Plane

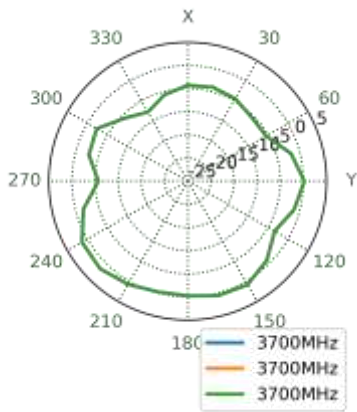

XZ Plane

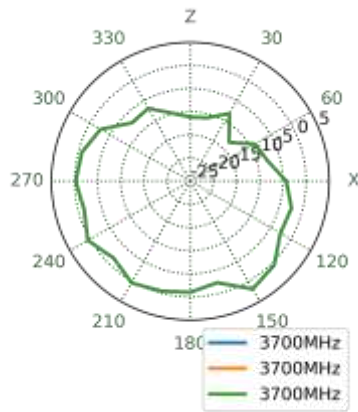

YZ Plane

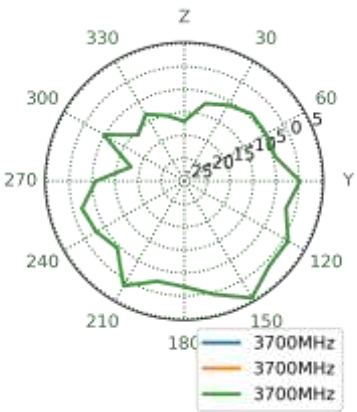

4800MHz

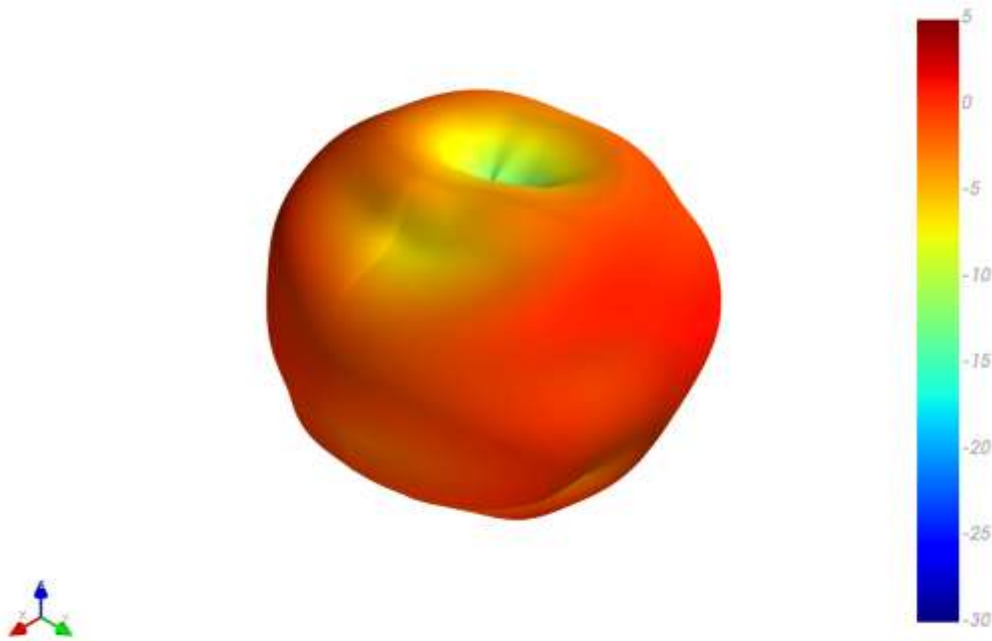

XY Plane

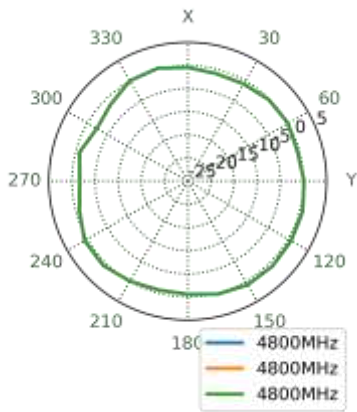

XZ Plane

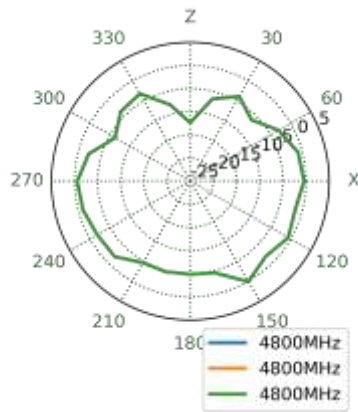

YZ Plane

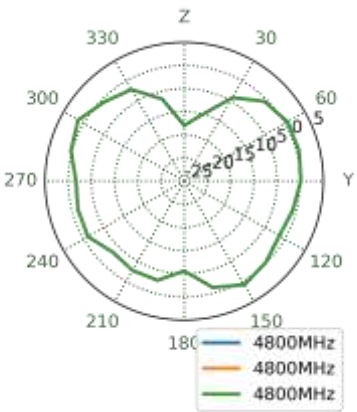

5550MHz

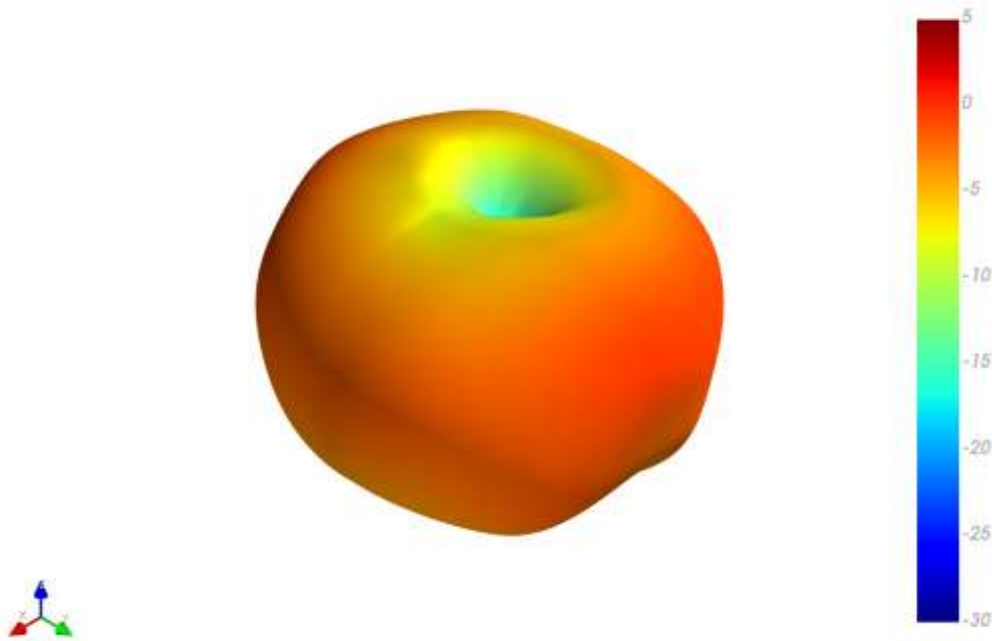

XY Plane

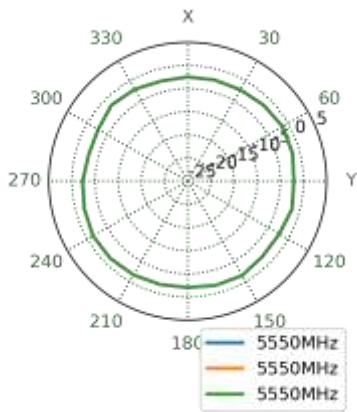

XZ Plane

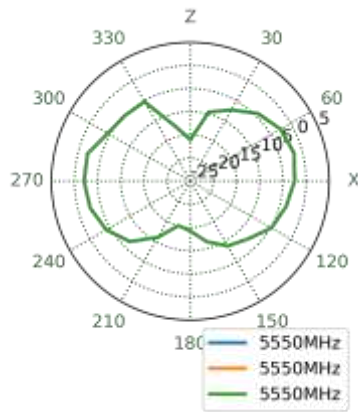

YZ Plane

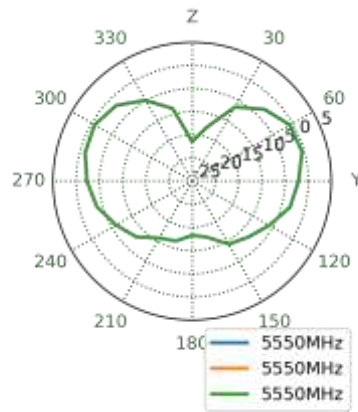

4.4 3D and 2D Radiation Patterns – 15*9cm Ground Plane Bent

1930MHz

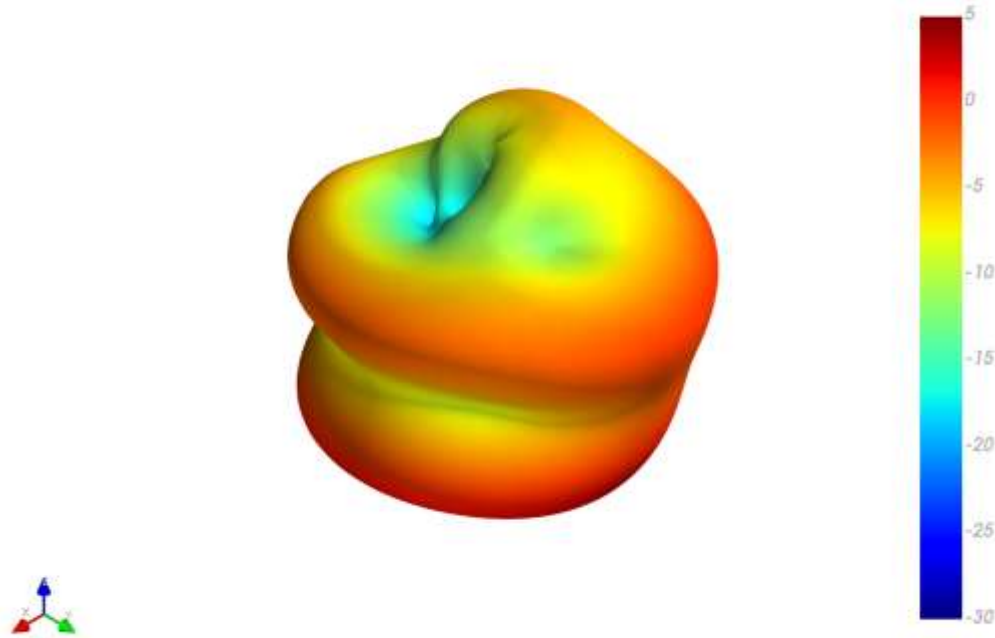

XY Plane

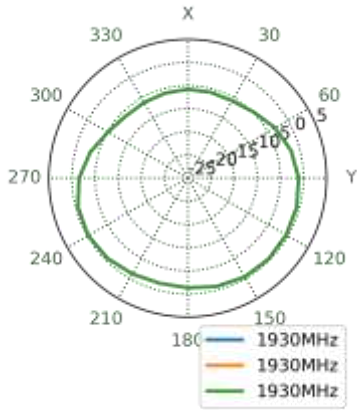

XZ Plane

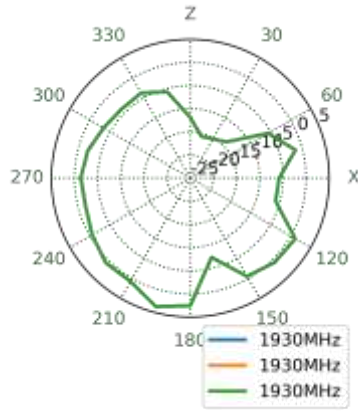

YZ Plane

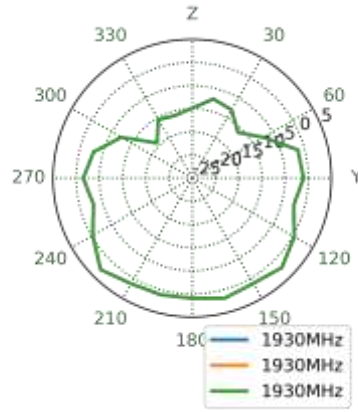

2496MHz

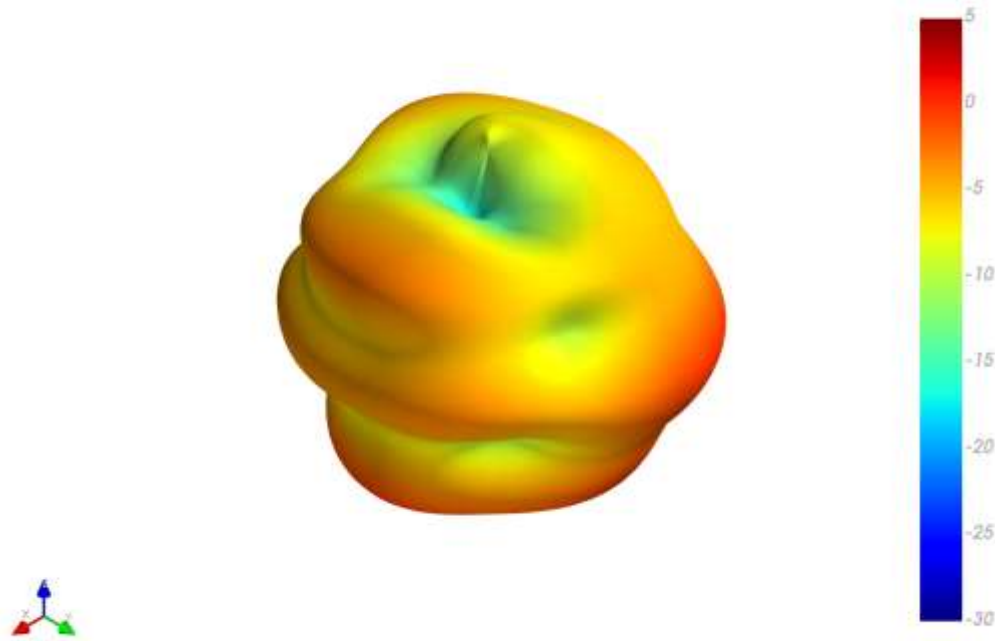

XY Plane

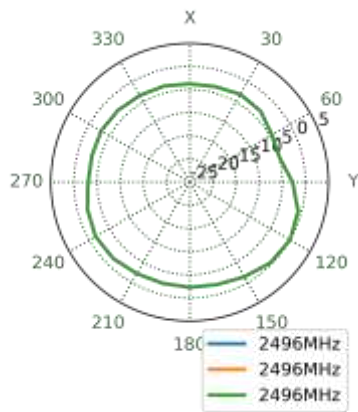

XZ Plane

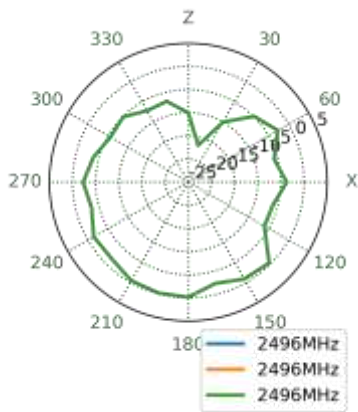

YZ Plane

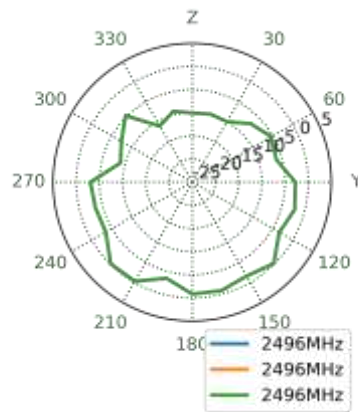

3550MHz

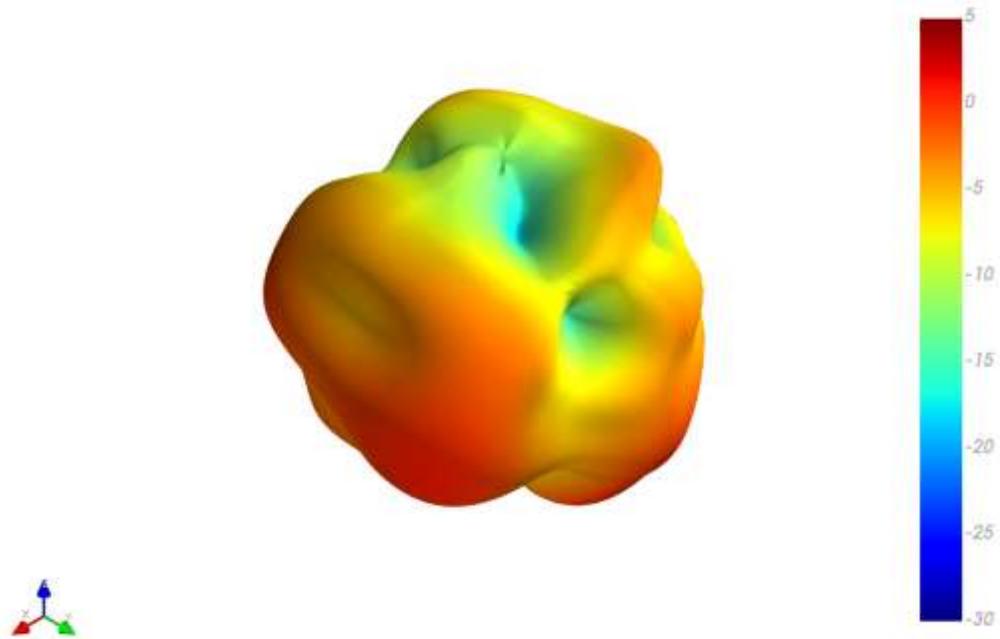

XY Plane

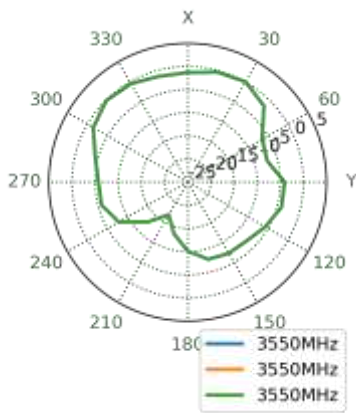

XZ Plane

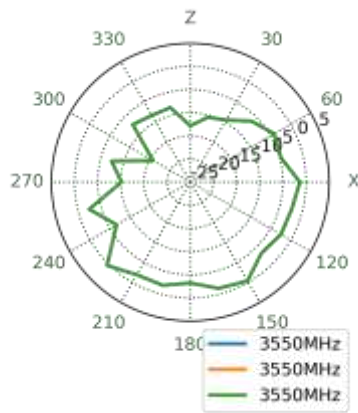

YZ Plane

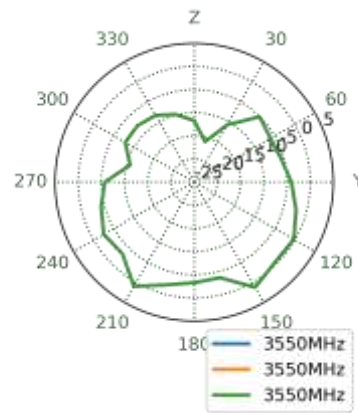

3700MHz

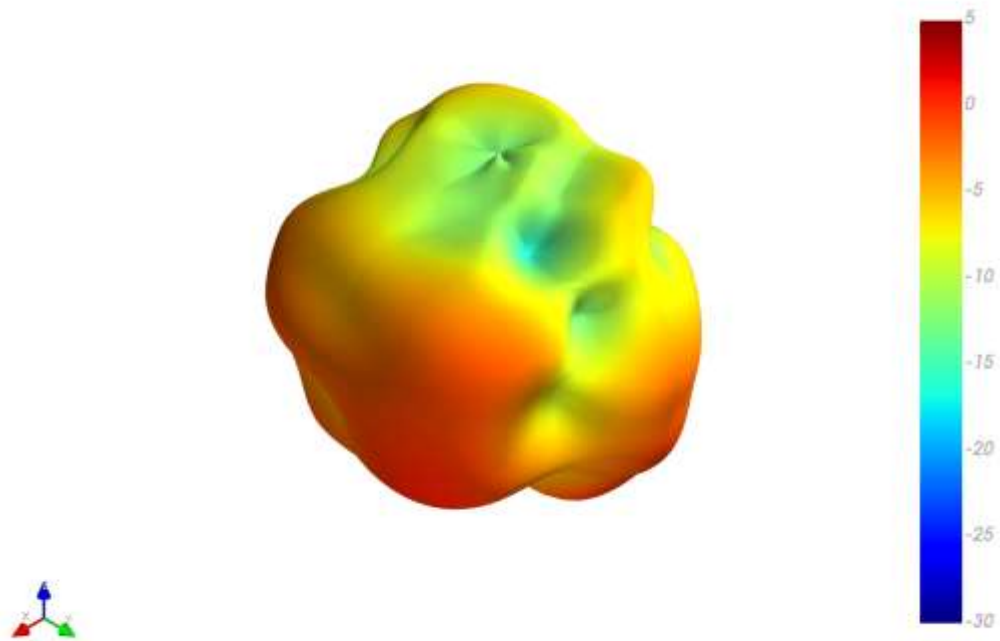

XY Plane

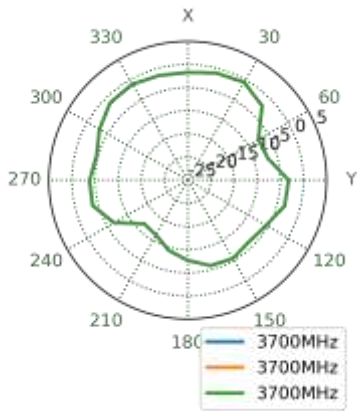

XZ Plane

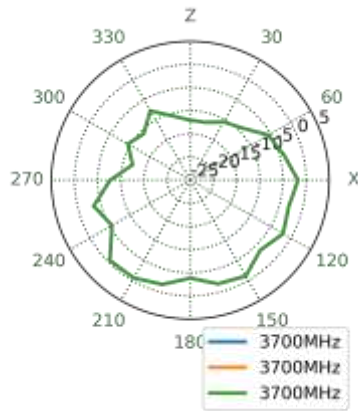

YZ Plane

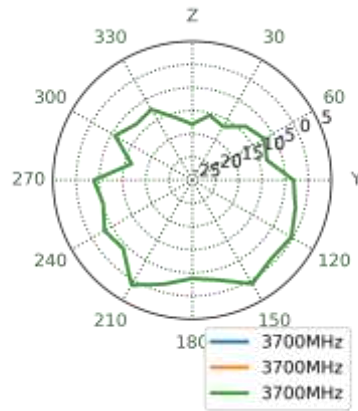

4800MHz

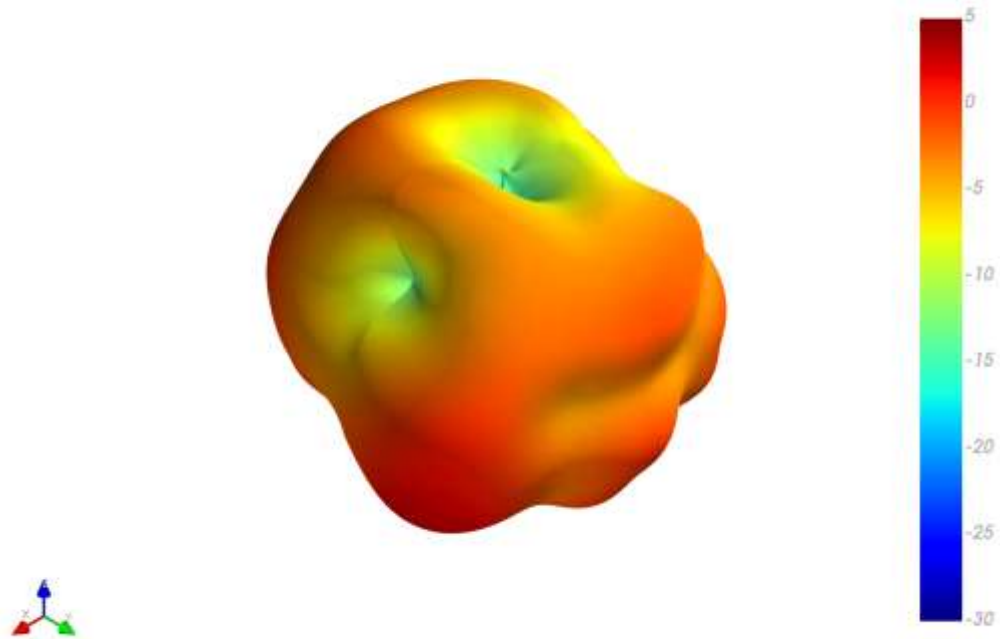

XY Plane

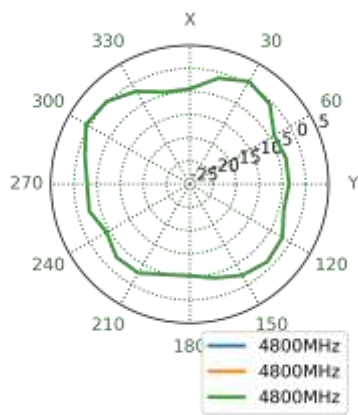

XZ Plane

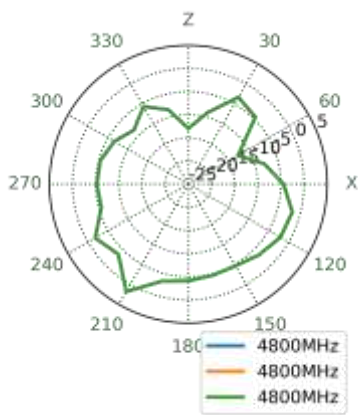

YZ Plane

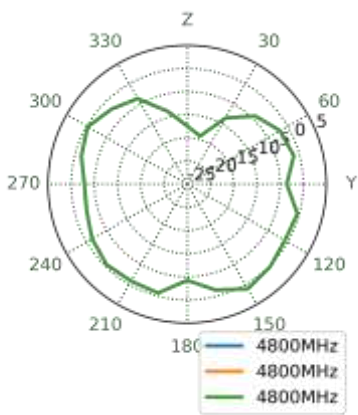

5550MHz

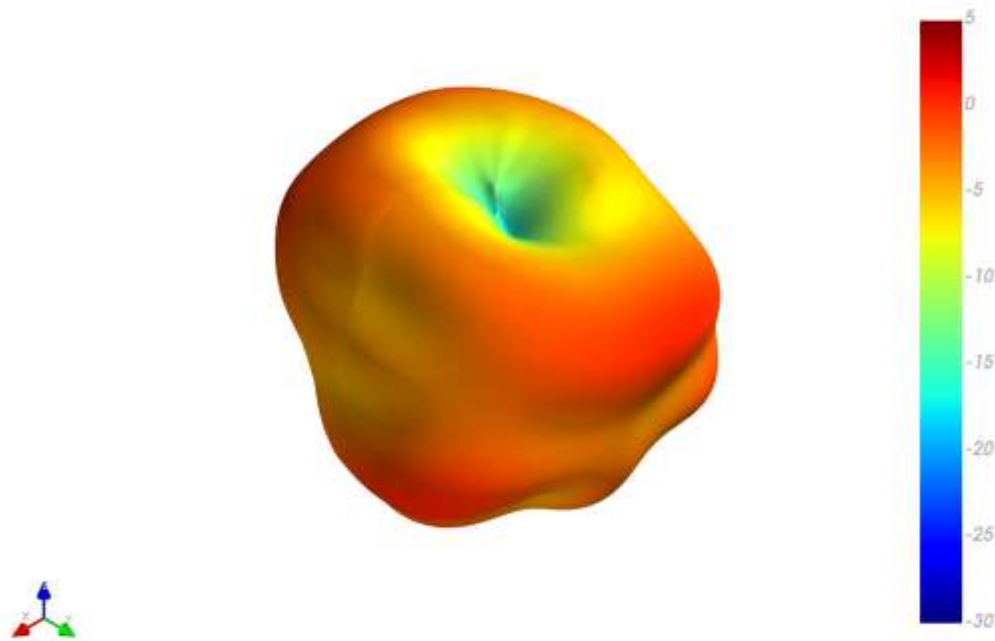

XY Plane

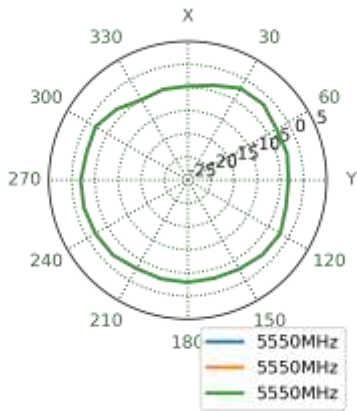

XZ Plane

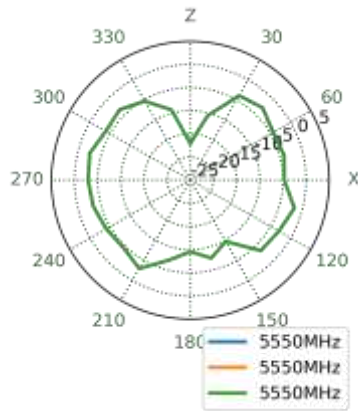

YZ Plane

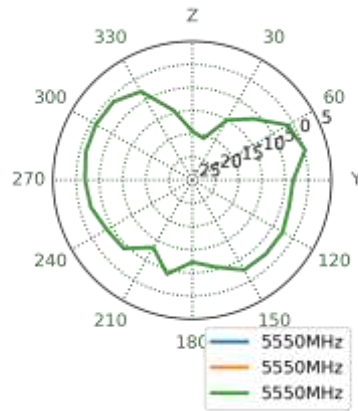

4.5 3D and 2D Radiation Patterns – 15*9cm Ground Plane Straight

1930MHz

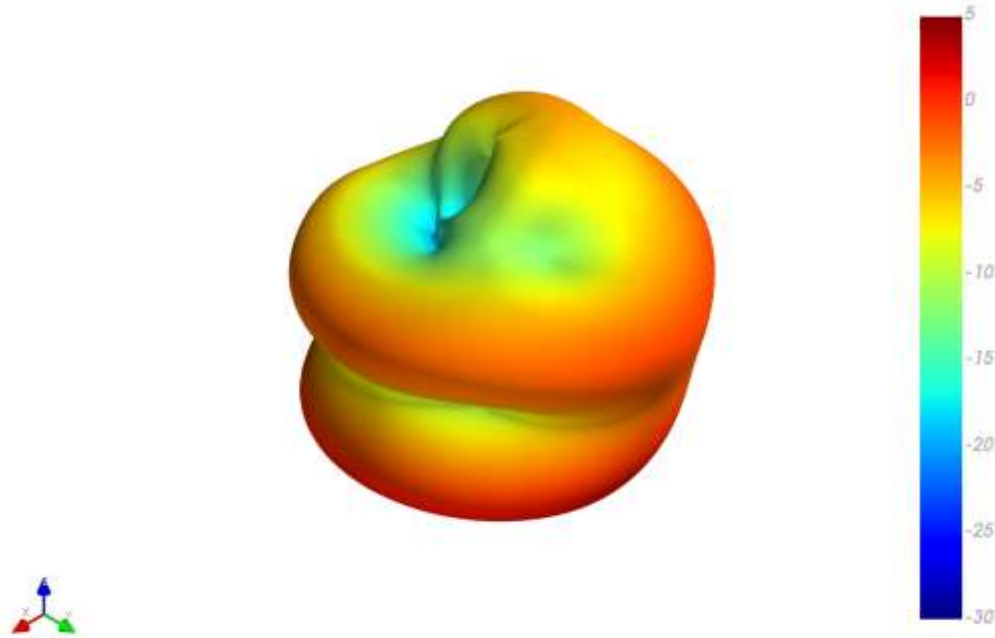

XY Plane

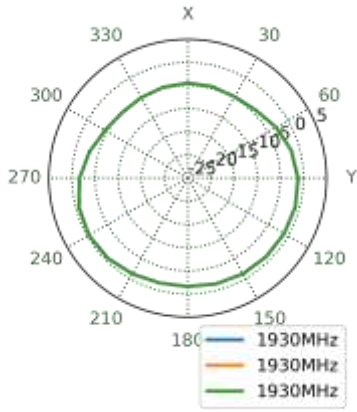

XZ Plane

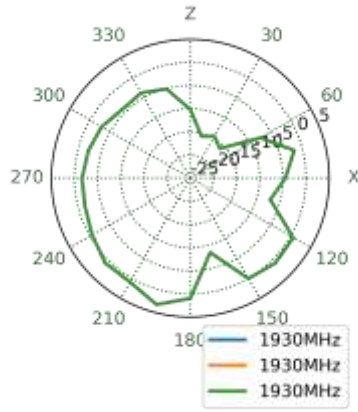

YZ Plane

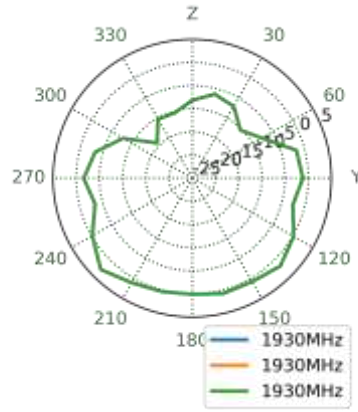

2496MHz

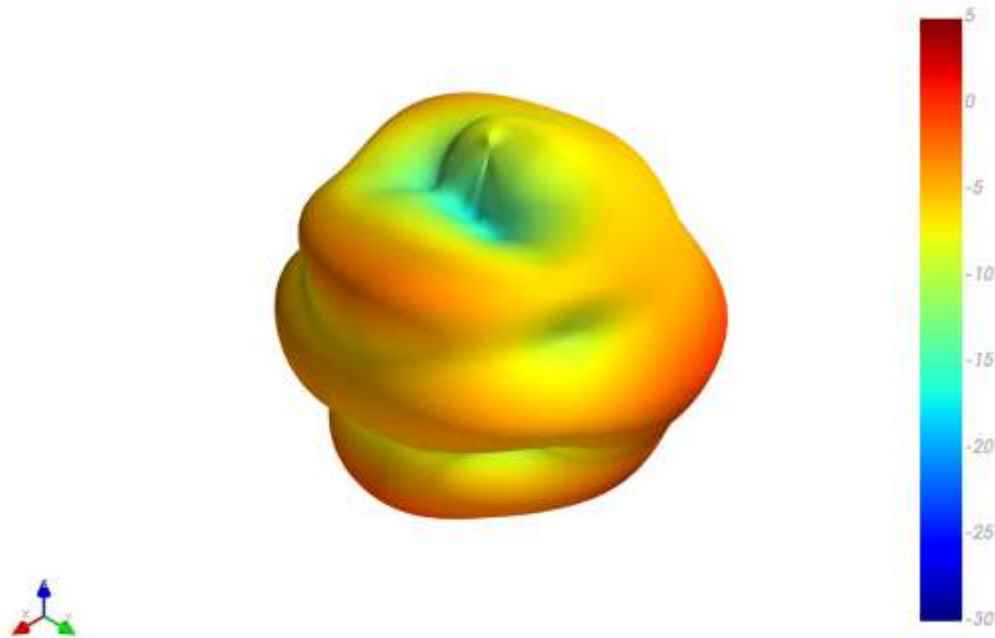

XY Plane

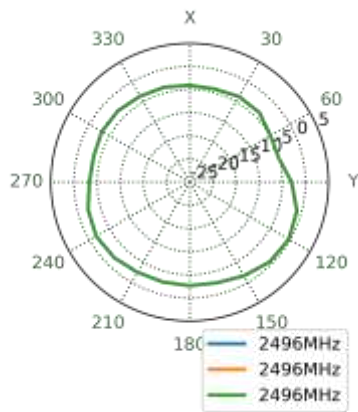

XZ Plane

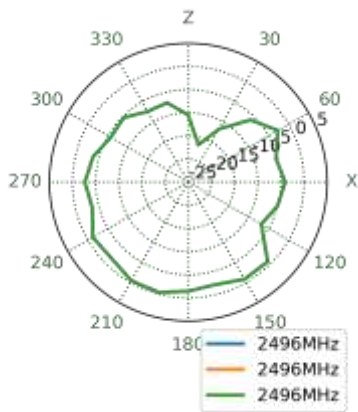

YZ Plane

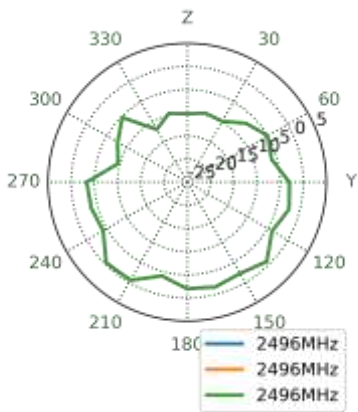

3550MHz

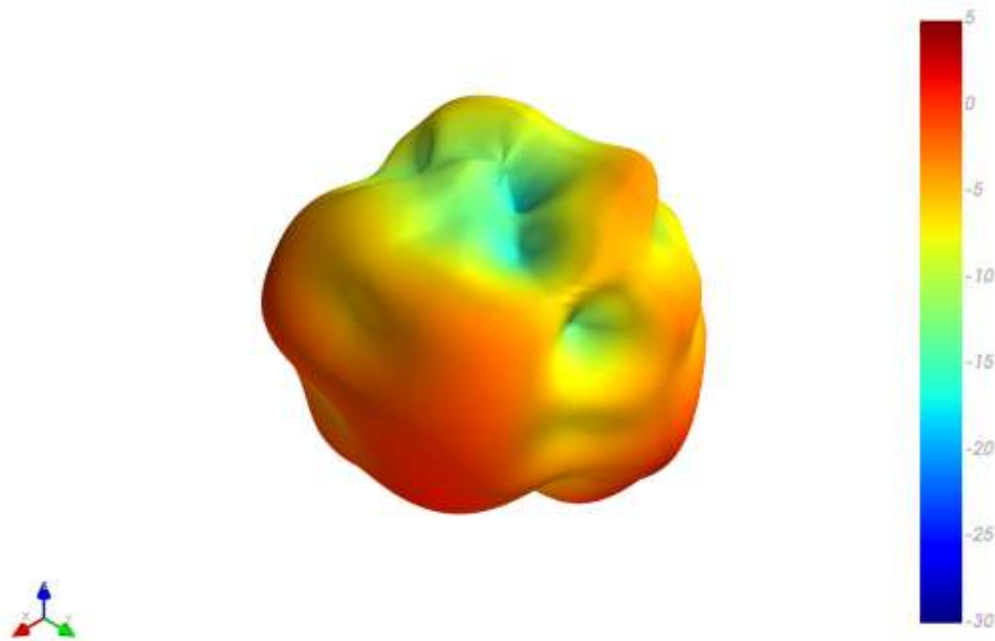

XY Plane

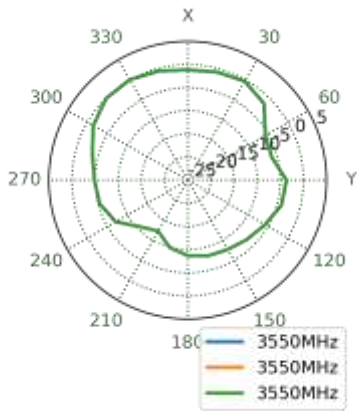

XZ Plane

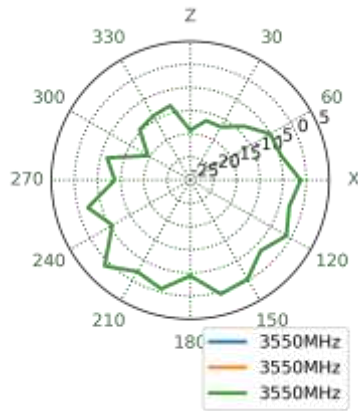

YZ Plane

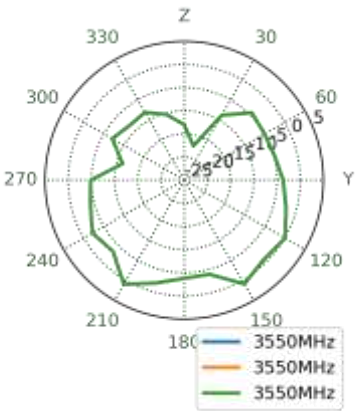

3700MHz

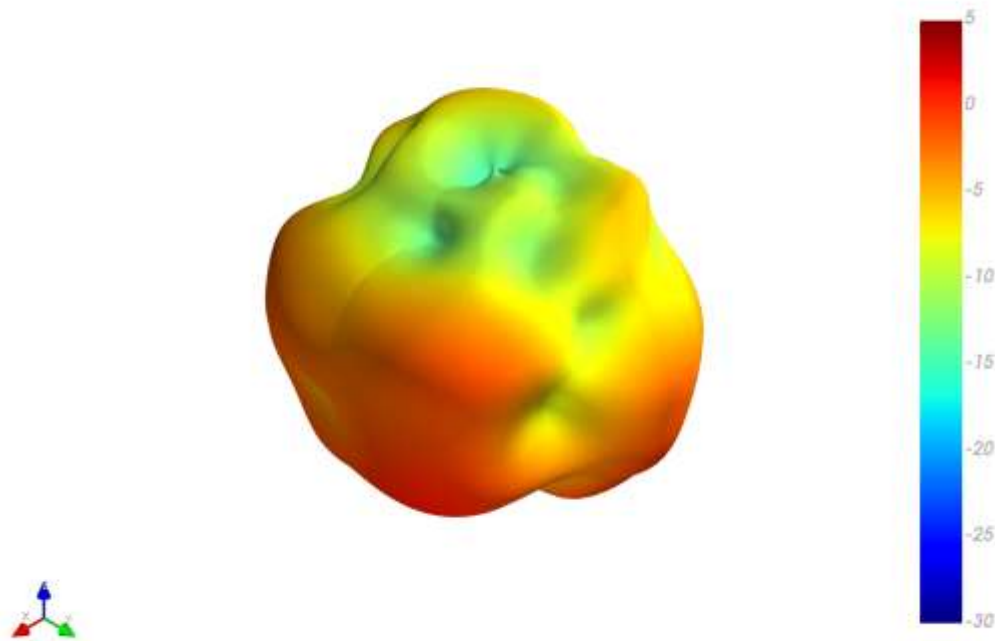

XY Plane

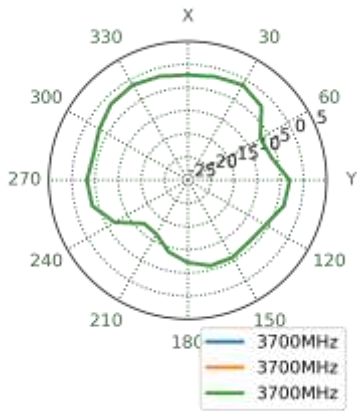

XZ Plane

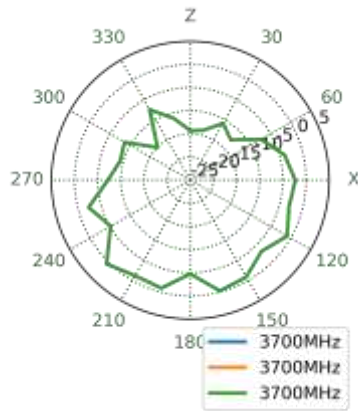

YZ Plane

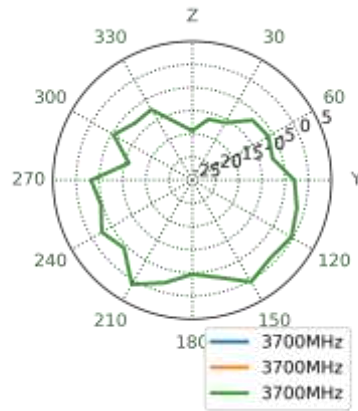

4800MHz

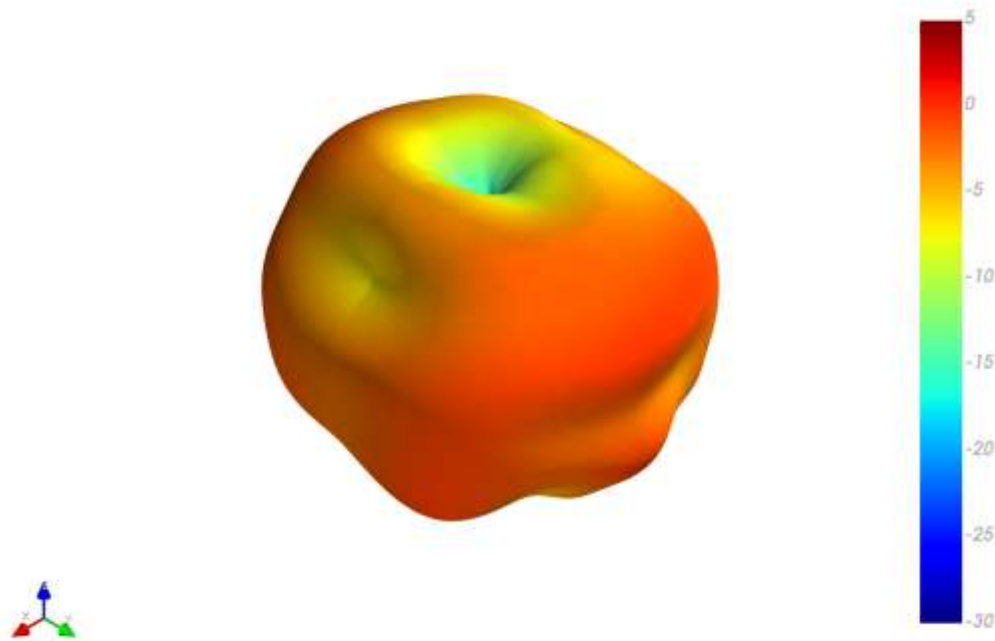

XY Plane

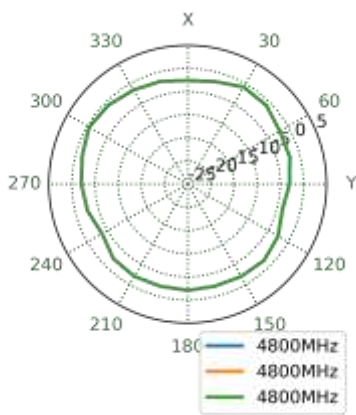

XZ Plane

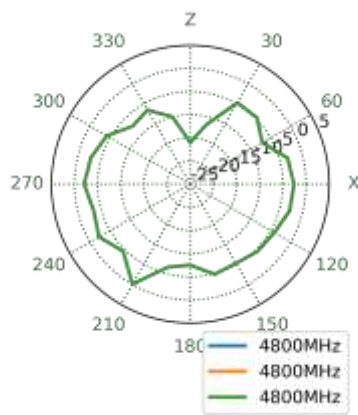

YZ Plane

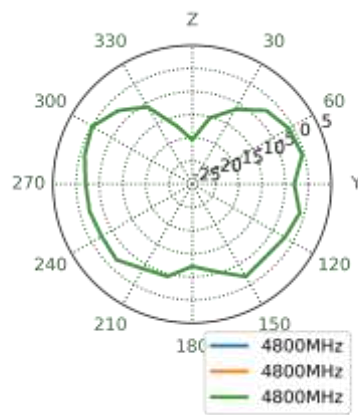

5550MHz

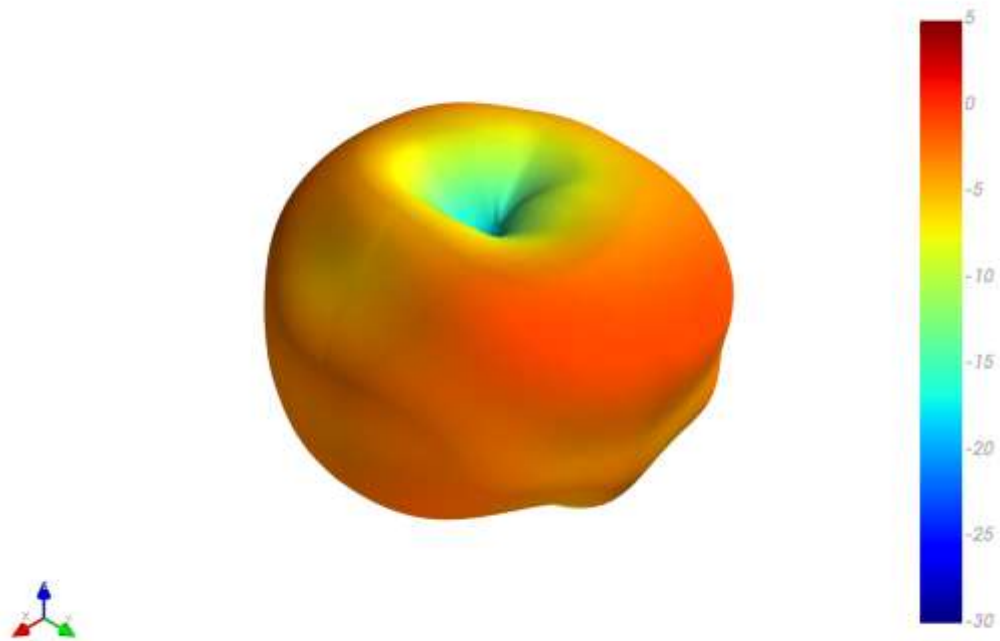

XY Plane

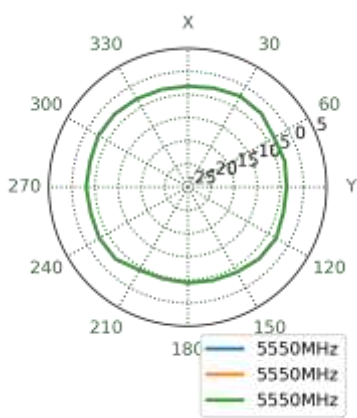

XZ Plane

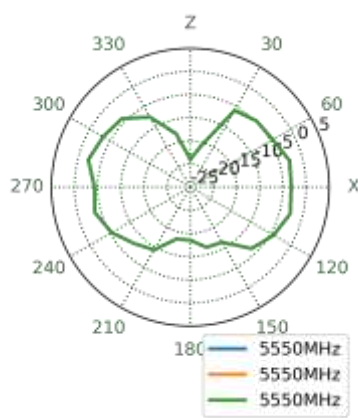

YZ Plane

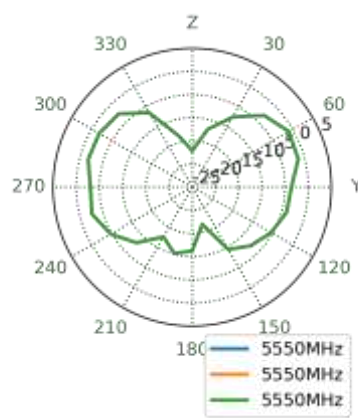

5. Mechanical Drawing (Units: mm)

ISO NO.: EDW-20-8-0598

STATE: Release

NOTES: 1. All material must be RoHS compliant.

REV.	DESCRIPTION	ENG.	APPROVED	DATE
1	Initial Design	Ruby	Clark	2020/07/09

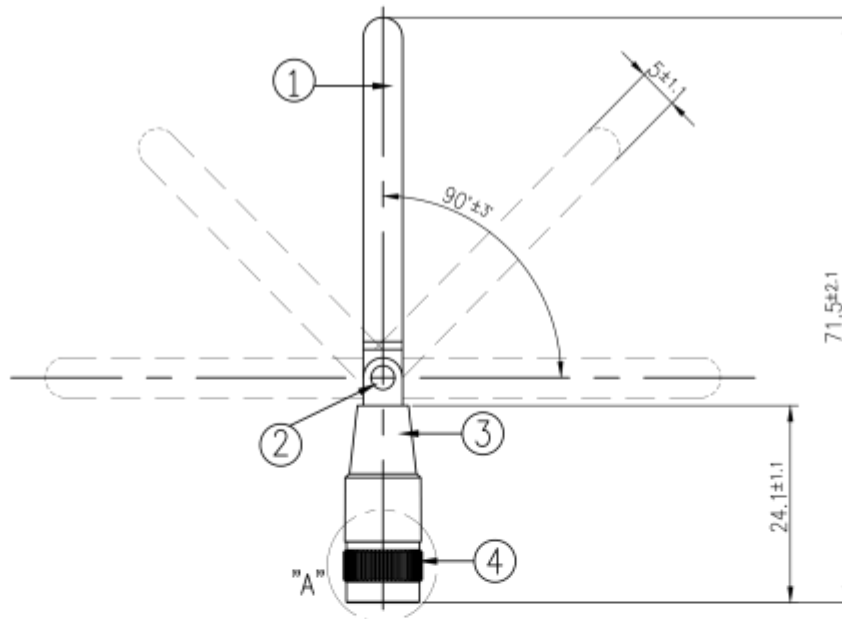
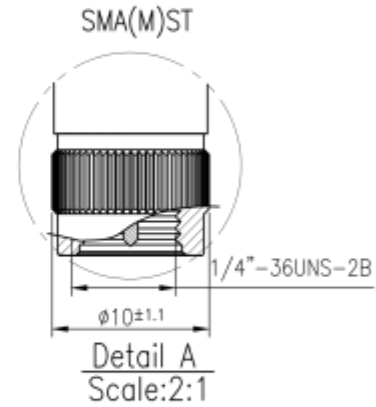

	Name	Material	Finish	QTY
1	Housing	ABS	Black	1
2	Hinge	Brass	Au Plated	1
3	Cap	ABS	Black	1
4	SMA(M)ST	Brass	Au Plated	1

APPROVED BY: Clark	 <small>This drawing and its inherent design concepts are property of Taoglas. Not to be copied or given to third parties without the written consent of Taoglas.</small>
CHECK BY: Aaron	
DRAWN BY: Ruby	
DATE: 2020/07/09	
UNLESS OTHERWISE SPECIFIED TOLERANCES ON:	TITLE : Connector Mount Monopole Antenna - Hinged SMA Male PART NO. : TG.59.0113
THIRD ANGLE PROJECTION	UNIT: mm SCALE: 1:25:1 PAGES: 1/1 REV. D01

6. Installation Recommendations

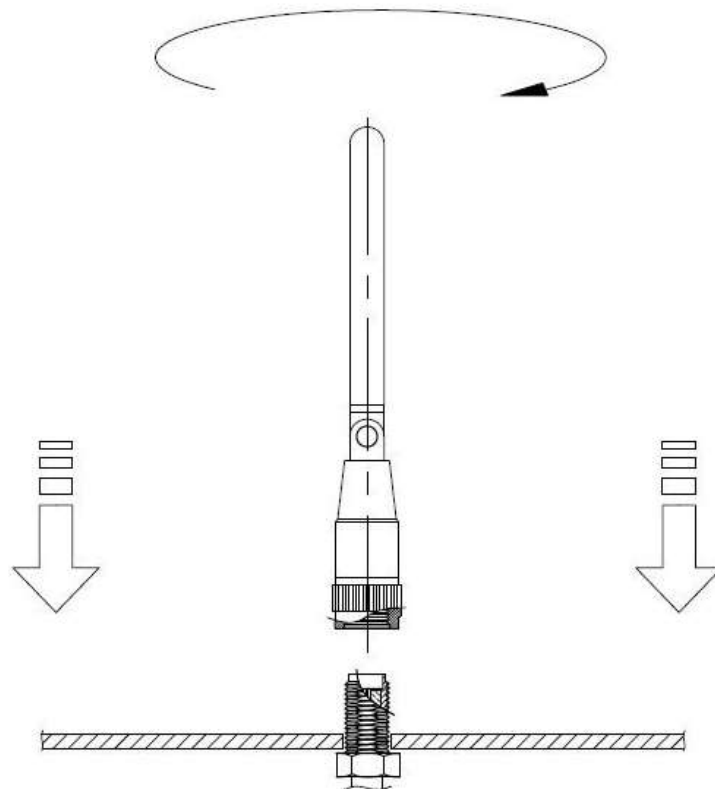

Recommended torque for mounting is 0.9 N·m
Maximum torque for mounting is 1.176 N·m

7. Packaging

1 pcs TG.59.0113 per PE bag
 PE Bag Dimensions - 74 x 42mm
 Weight - 8.6g

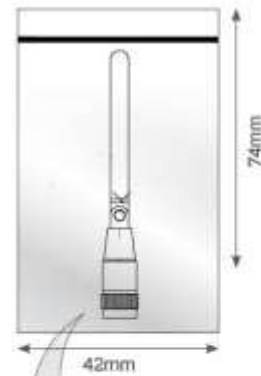

100 PE bags per large PE bags
 100 pcs TG.59.0113 per large PE bags
 Large PE bags Dimensions - 280 x 180mm
 Weight - 0.88kg

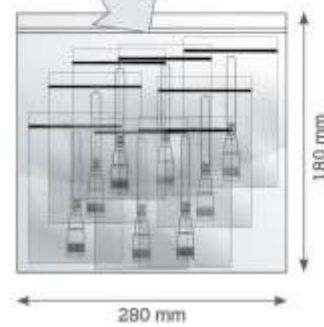

15 Large PE bags per carton
 1500 pcs TG.59.0113 per carton
 Carton Dimensions - 360 x 310 x 160mm
 Weight - 13.5kg

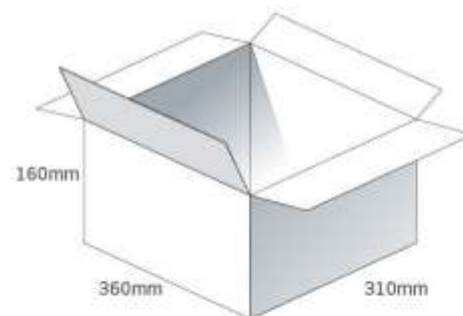

Pallet Dimensions 1200*1000*1480mm
 72 Cartons per Pallet
 9 Cartons per layer
 8 Layers

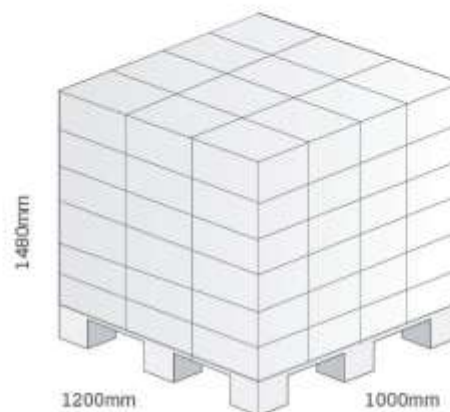

Changelog for the datasheet

SPE-20-8-084 – TG.59.0113

Revision: B (Current Version)

Date:	2021-07-05
Notes:	Updated 2/3D Radiation Patterns
Author:	Gary West

Revision: A (Original First Release)

Date:	2020-09-15
Notes:	Initial Release
Author:	Jack Conroy



www.taoglas.com