



SCREW-HOLE PUNCHES



Screw-hole punches

Cuts holes in thin materials quickly, easily, cleanly and without burrs in a few simple operations.

Three-point cut gives improved contact and thus less deformation of the punched parts, preventing damage to the draw-in bolt.

The ball bearing between draw-in bolt and die plate makes handling even simpler and quicker, reducing the force required by approx. 67 %.

Before the screw-hole punch is used, the draw-in bolt should always be lubricated with RUKO cutting spray or cutting paste.

The metric draw-in bolts of RUKO screw-hole punches are always of the highest quality grade and are thus designed for extreme loads. If lost, they can be replaced for short periods of time by standard metric fine threaded bolts.

Particularly suitable for use with spanners, manual or foot-operated hydraulic punches.

Special sizes available on request.

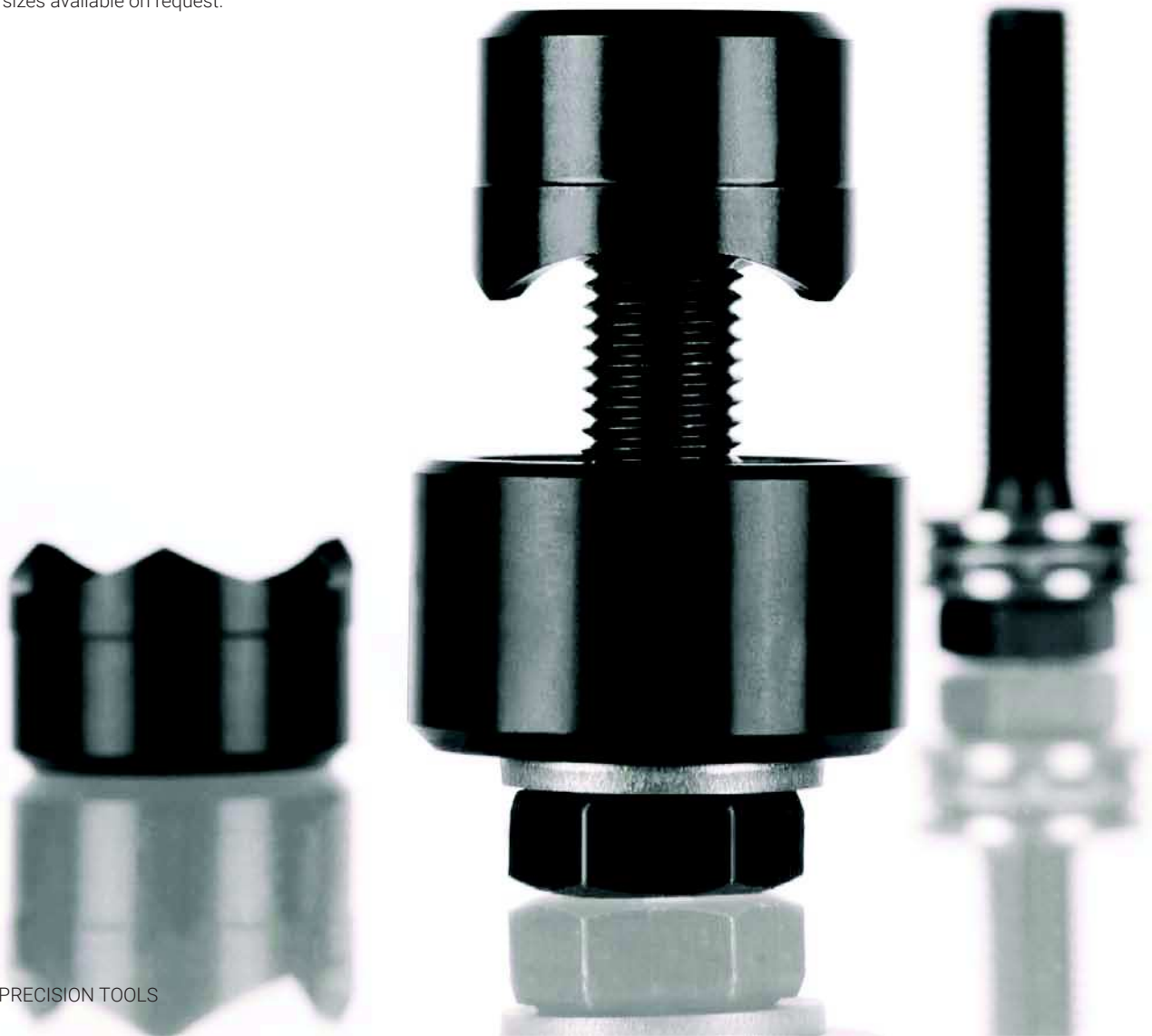

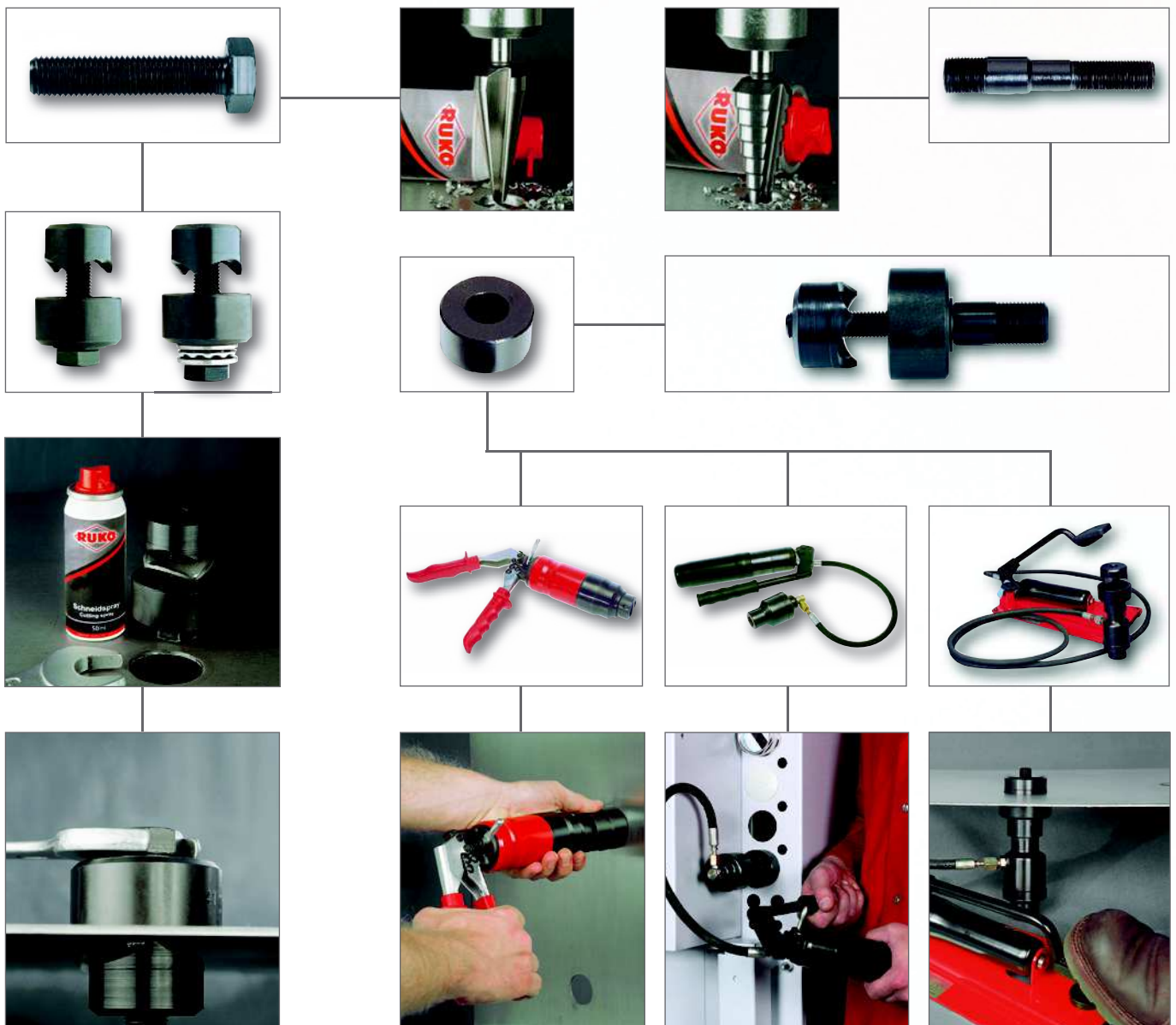

Recommendations for the use of screw-hole punches

Draw-in bolt	Sheet steel	Stainless-steel sheets	Non-ferrous and light metals	Plastics
MF 8 x 1,0 mm	2,0 mm	1,0 mm	4,0 mm	4,0 mm
MF 10 x 1,0 mm	2,0 mm	1,0 mm	4,0 mm	4,0 mm
MF 12 x 1,5 mm	3,0 mm	1,5 mm	4,0 mm	4,0 mm
MF 16 x 1,5 mm	3,0 mm	1,5 mm	4,0 mm	4,0 mm



Screw-hole punches with three-point cutting tip

Die: three-point cutting tip
 Material: special steel
 Draw-in bolt: metric fine-threads, from MF 10 grade 12.9

Suitable for sheet steel, stainless-steel sheets, non-ferrous and light metals, plastics.
 Ideal for switchgear manufacturers, electricians, plumbers, industry and handicrafts.



The through hole should be only slightly bigger than the diameter (+ 1.0 mm) of the traction bolt. Apply (spread) RUKO lubricating paste on the cutting edges and the traction bolt. This reduces wear and thus increases the service life of the screw hole punch.

Packing unit: individual cartons

Ø mm	Through dimensions		Conduit & Pipe Size	Ø inch	Draw-in bolt MF	Article no. standard	Article no. ball bearing	
	M	PG						
12,7	12	7		1/2"	MF 8	109 127	—	1
15,2		9			MF 10	109 152	109 152 K	1
16,0					MF 10	109 160	109 160 K	1
16,5	16				MF 10	109 165	109 165 K	1
18,6		11			MF 10	109 186	109 186 K	1
19,0				3/4"	MF 10	109 190	109 190 K	1
20,0					MF 10	109 200	109 200 K	1
20,4	20	13,5			MF 10	109 204	109 204 K	1
21,0					MF 10	109 210	109 210 K	1
22,0					MF 10	109 220	109 220 K	1
22,5		16	1/2"	7/8"	MF 10	109 225	109 225 K	1
23,0					MF 10	109 230	109 230 K	1
24,0					MF 10	109 240	109 240 K	1
25,0					MF 10	109 250	109 250 K	1
25,4	25			1"	MF 10	109 254	109 254 K	1
26,0					MF 10	109 260	109 260 K	1
27,0					MF 10	109 270	109 270 K	1
28,3		21	3/4"		MF 12	109 283	109 283 K	1
29,0					MF 12	109 290	109 290 K	1
30,0					MF 12	109 300	109 300 K	1
30,5				1 7/32"	MF 12	109 305	109 305 K	1
31,0					MF 12	109 310	109 310 K	1
31,7					MF 12	109 317	109 317 K	1
32,0					MF 12	109 320	109 320 K	1
32,5	32				MF 12	109 325	109 325 K	1
33,0					MF 12	109 330	109 330 K	1
34,0					MF 12	109 340	109 340 K	1
35,0				1 3/8"	MF 12	109 350	109 350 K	1
36,0					MF 12	109 360	109 360 K	1
37,0		29			MF 12	109 370	109 370 K	1
38,0				1 1/2"	MF 12	109 380	109 380 K	1
40,0	40				MF 12	109 400	109 400 K	1
40,5					MF 16	109 405	109 405 K	1
42,0					MF 16	109 420	109 420 K	1
43,0			1 1/4"		MF 16	109 430	109 430 K	1
45,0					MF 16	109 450	109 450 K	1
47,0		36			MF 16	109 470	109 470 K	1
50,0			1 1/2"		MF 16	109 500	109 500 K	1
50,5	50				MF 16	109 505	109 505 K	1
51,0					MF 16	109 510	109 510 K	1
53,0					MF 16	109 530	109 530 K	1
54,0		42		2 1/8"	MF 16	109 540	109 540 K	1
55,0					MF 16	109 550	109 550 K	1
60,0		~ 48			MF 16	109 600	109 600 K	1
61,5			2"	2 3/8"	MF 16	109 615	109 615 K	1
63,5	63			2 1/2"	MF 16	109 635	109 635 K	1

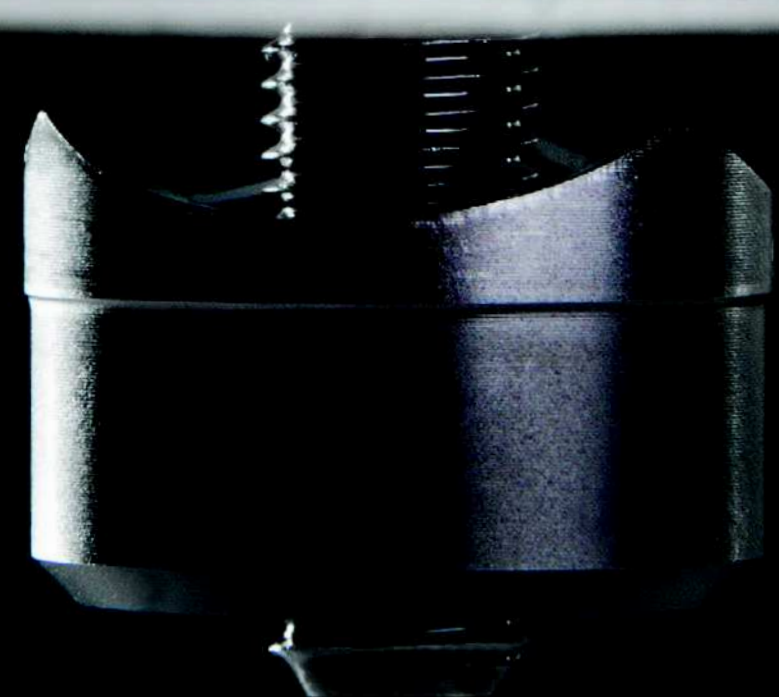
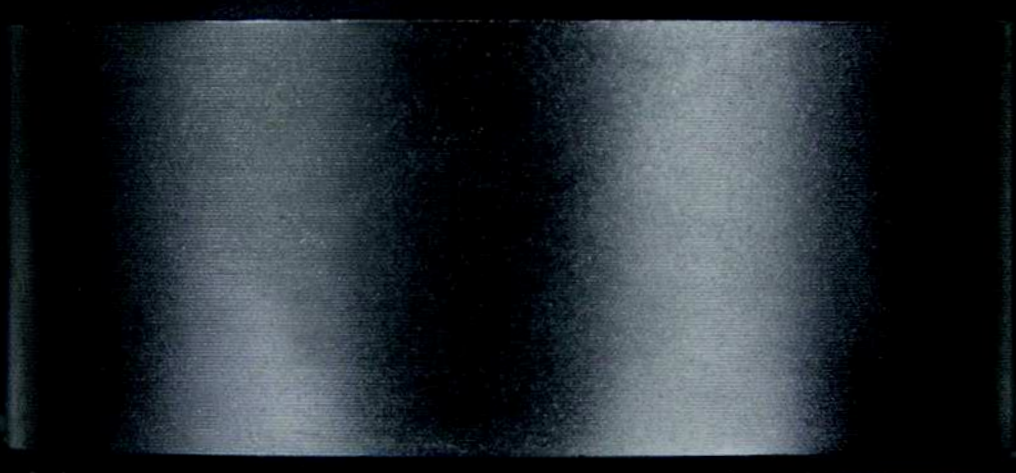
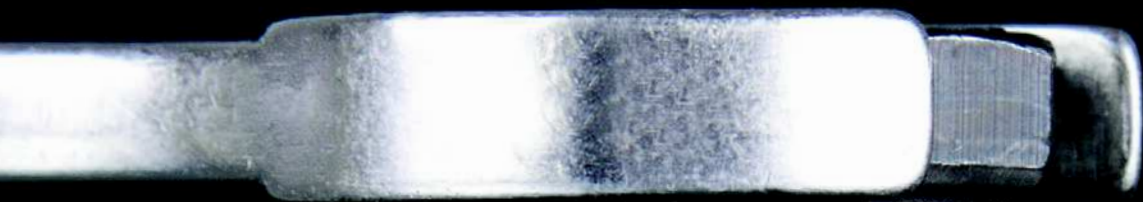

Sets of screw-hole punches in plastic cases

		Article no.
Set 1	11 - piece set of screw-hole punches 6 screw-hole punches Ø 15,2 (PG 9) - 18,6 (PG 11) - 20,4 (M 20 / PG 13,5) - 22,5 (PG 16) - 28,3 (PG 21) + 32,0 mm + 1 tube and sheet drill HSS size 1 + 1 cutting paste 30 g + 2 draw-in bolts MF 10 x 1,0 x 45, grade 12.9 + 1 draw-in bolt MF 12 x 1,5 x 55, grade 12.9	109 002
Set 2	13 - piece set of screw-hole punches 8 screw-hole punches Ø 15,2 (PG 9) - 18,6 (PG 11) - 20,4 (M 20 / PG 13,5) - 22,5 (PG 16) - 28,3 (PG 21) 37,0 (PG 29) - 47,0 (PG 36) + 54,0 mm (PG 42) + 1 tube and sheet drill HSS size 2 + 1 cutting paste 30 g + 1 draw-in bolt MF 10 x 1,0 x 45, grade 12.9 + 1 draw-in bolt MF 12 x 1,5 x 55, grade 12.9 + 1 draw-in bolt MF 16 x 1,5 x 60, grade 12.9	109 003
Set 3	10 - piece set of screw-hole punches 5 screw-hole punches Ø 16,5 (M 16) - 20,4 (M 20 / PG 13,5) - 25,4 (M 25) - 32,5 (M 32) + 40,5 mm (M 40) + 1 tube and sheet drill HSS size 2 + 1 cutting paste 30 g + 1 draw-in bolt MF 10 x 1,0 x 45, grade 12.9 + 1 draw-in bolt MF 12 x 1,5 x 55, grade 12.9 + 1 draw-in bolt MF 16 x 1,5 x 60, grade 12.9	109 006
Set 4	12 - piece set of screw-hole punches 7 screw-hole punches Ø 16,5 (M 16) - 20,4 (M 20 / PG 13,5) - 25,4 (M 25) - 32,5 (M 32) - 40,5 (M 40) 50,5 (M 50) + 63,5 mm (M 63) + 1 tube and sheet drill HSS size 2 + 1 cutting paste 30 g + 1 draw-in bolt MF 10 x 1,0 x 45, grade 12.9 + 1 draw-in bolt MF 12 x 1,5 x 55, grade 12.9 + 1 draw-in bolt MF 16 x 1,5 x 60, grade 12.9	109 008





Sets of screw-hole punches with ball-bearing in plastic cases

		Article no.
Set 1 K	11 - piece set of screw-hole punches 6 screw-hole punches Ø 15,2 (PG 9) - 18,6 (PG 11) - 20,4 (M 20 / PG 13,5) - 22,5 (PG 16) - 28,3 (PG 21) + 32,0 mm + 1 tube and sheet drill HSS size 1 + 1 cutting paste 30 g + 2 ball-bearing draw-in bolts MF 10 x 1,0 x 50, grade 12.9 + 1 ball-bearing draw-in bolt MF 12 x 1,5 x 60, grade 12.9	109 002 K
Set 2 K	13 - piece set of screw-hole punches 8 screw-hole punches Ø 15,2 (PG 9) - 18,6 (PG 11) - 20,4 (M 20 / PG 13,5) - 22,5 (PG 16) - 28,3 (PG 21) 37,0 (PG 29) - 47,0 (PG 36) + 54,0 mm (PG 42) + 1 tube and sheet drill HSS size 2 + 1 cutting paste 30 g + 1 ball-bearing draw-in bolt MF 10 x 1,0 x 50, grade 12.9 + 1 ball-bearing draw-in bolt MF 12 x 1,5 x 60, grade 12.9 + 1 ball-bearing draw-in bolt MF 16 x 1,5 x 70, grade 12.9	109 003 K
Set 3 K	10 - piece set of screw-hole punches 5 screw-hole punches Ø 16,5 (M 16) - 20,4 (M 20 / PG 13,5) - 25,4 (M 25) - 32,5 (M 32) + 40,5 mm (M 40) + 1 tube and sheet drill HSS size 2 + 1 cutting paste 30 g + 1 ball-bearing draw-in bolt MF 10 x 1,0 x 50, grade 12.9 + 1 ball-bearing draw-in bolt MF 12 x 1,5 x 60, grade 12.9 + 1 ball-bearing draw-in bolt MF 16 x 1,5 x 70, grade 12.9	109 006 K
Set 4 K	12 - piece set of screw-hole punches 7 screw-hole punches Ø 16,5 (M 16) - 20,4 (M 20 / PG 13,5) - 25,4 (M 25) - 32,5 (M 32) - 40,5 (M 40) 50,5 (M 50) + 63,5 mm (M 63) + 1 tube and sheet drill HSS size 2 + 1 cutting paste 30 g + 1 ball-bearing draw-in bolt MF 10 x 1,0 x 50, grade 12.9 + 1 ball-bearing draw-in bolt MF 12 x 1,5 x 60, grade 12.9 + 1 ball-bearing draw-in bolt MF 16 x 1,5 x 70, grade 12.9	109 008 K



Set of foot-operated hydraulic punch in plastic case

	Article no.
Foot-operated hydraulic punch, complete + 1 distance sleeve + 1 adapter bolt MF 10 x 1,0, 3/4" UNF fitting + 1 adapter bolt MF 12 x 1,5, 3/4" UNF fitting + 1 adapter bolt MF 16 x 1,5, 3/4" UNF fitting pulling power 50 kN	109 301



109 301

Sets of manual hydraulic punch in plastic case

	Article no.
Compact manual hydraulic punch, complete + 1 distance sleeve + 1 adapter bolt MF 10 x 1,0, 3/4" UNF fitting + 1 adapter bolt MF 12 x 1,5, 3/4" UNF fitting + 1 adapter bolt MF 16 x 1,5, 3/4" UNF fitting pulling power 50 kN	109 101
Manual hydraulic punch, complete + 1 distance sleeve + 1 adapter bolt MF 10 x 1,0, 3/4" UNF fitting + 1 adapter bolt MF 12 x 1,5, 3/4" UNF fitting + 1 adapter bolt MF 16 x 1,5, 3/4" UNF fitting pulling power 50 kN	109 201



109 101



109 201

Sets of screw-hole punches with compact manual hydraulic punch in plastic case

	Article no.
12 - piece set of screw-hole punches with compact manual hydraulic punch 1 compact manual hydraulic punch + 8 screw-hole punches Ø 16,5 (M 16) - 20,4 (M 20 / PG 13,5) - 25,4 (M 25) - 32,5 (M 32) - 40,5 (M 40) + 50,5 mm (M 50) + 1 tube and sheet drill HSS size 2 + 1 cutting paste 30 g + 1 distance sleeve + 1 adapter bolt MF 10 x 1,0, 3/4" UNF fitting + 1 adapter bolt MF 12 x 1,5, 3/4" UNF fitting + 1 adapter bolt MF 16 x 1,5, 3/4" UNF fitting pulling power 50 kN	109 009
14 - piece set of screw-hole punches with compact manual hydraulic punch 1 compact manual hydraulic punch + 8 screw-hole punches Ø 15,2 (PG 9) - 18,6 (PG11) - 20,4 (M 20 / PG 13,5) - 22,5 (PG 16) - 28,3 (PG 21) - 37,0 (PG 29) - 47,0 (PG 36) + 54,0 mm (PG 42) + 1 tube and sheet drill HSS size 2 + 1 cutting paste 30 g + 1 distance sleeve + 1 adapter bolt MF 10 x 1,0, 3/4" UNF fitting + 1 adapter bolt MF 12 x 1,5, 3/4" UNF fitting + 1 adapter bolt MF 16 x 1,5, 3/4" UNF fitting pulling power 50 kN	109 004



109 009



109 004



Spare parts

Packing unit: individual plastic packing

	Article no.
Distance sleeve	109 000
Adapter bolt MF 10 x 1,0, 3/4" UNF fitting	109 110
Adapter bolt MF 12 x 1,5, 3/4" UNF fitting	109 112
Adapter bolt MF 16 x 1,5, 3/4" UNF fitting	109 116
Replacement bolt MF 8 x 1,0 x 40, grade 12,9	103 108
Replacement bolt MF 10 x 1,0 x 45, grade 12,9	103 110
Replacement bolt MF 12 x 1,5 x 55, grade 12,9	103 112
Replacement bolt MF 16 x 1,5 x 60, grade 12,9	103 116
Replacement bolt with ball-bearing MF 10 x 1,0 x 50 grade 12,9	103 110 K
Replacement bolt with ball-bearing MF 12 x 1,5 x 60 grade 12,9	103 112 K
Replacement bolt with ball-bearing MF 16 x 1,5 x 70 grade 12,9	103 116 K

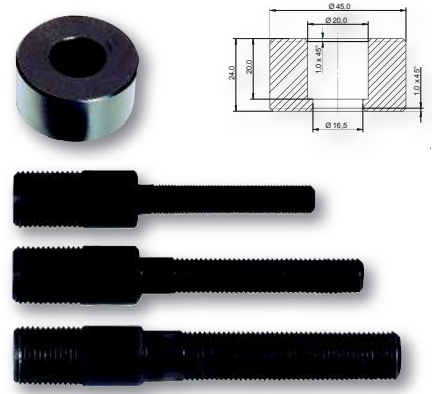

The adapter bolts may be used on all standard hydraulic punches.

