

### 40 Watts

- Fully Encapsulated Chassis Mount
- Wide 4:1 Input Range
- ITE Safety Approvals
- -40 °C to +95 °C Operating Temperature
- High Efficiency up to 92 %
- Optional DIN Rail Version
- Remote On/Off
- EN55032 Conducted Level A With No External Components
- 3 Year Warranty



#### Dimensions:

##### DTE40:

4.41 x 2.51 x 1.01" (112 x 63.8 x 25.6 mm)

### Models & Ratings

Input Voltage	Output Voltage	Output Current	Input Current <sup>(1,4)</sup>		Maximum Capacitive Load	Efficiency <sup>(2)</sup>	Model Number <sup>(3)</sup>
			No Load	Full Load			
24 V (9-36 V)	5.1 V	8.0 A	90 mA	1.89 A	13,600 µF	90%	DTE4024S5V1
	12.0 V	3.33 A	90 mA	1.85 A	2,400 µF	90%	DTE4024S12
	24.0 V	1.67 A	90 mA	1.86 A	600 µF	90%	DTE4024S24
	48.0 V	0.835 A	90 mA	1.88 A	150 µF	89%	DTE4024S48
48 V (18-75 V)	5.1 V	8.0 A	55 mA	0.96 A	13,600 µF	89%	DTE4048S5V1
	12.0 V	3.33 A	55 mA	0.92 A	2,400 µF	91%	DTE4048S12
	24.0 V	1.67 A	55 mA	0.91 A	600 µF	92%	DTE4048S24
	48.0 V	0.835 A	55 mA	0.93 A	150 µF	90%	DTE4048S48

### Notes

1. Input current measured at nominal input voltage.
2. Typical values.
3. For optional version fitted with Din Clip add suffix '-D' e.g. DTE4024S24-D.
4. Input current is typically 3 mA at nominal input voltage when output is remotely turned off.

### Mechanical Details

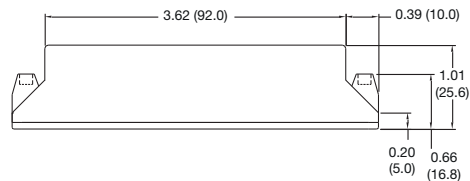
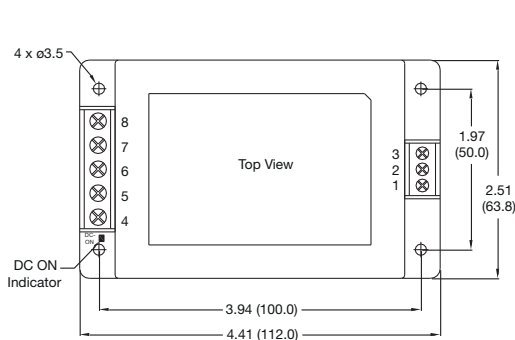

#### -D Version

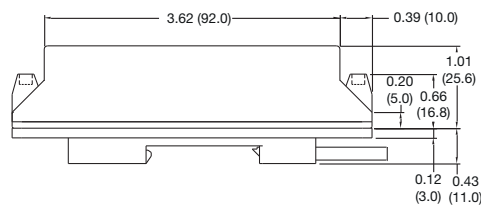

Pin Connections	
Pin	Function
1	Remote On/Off
2	-Vin
3	+Vin
4	+Vout
5	No Connection
6	-Vout
7	No Connection
8	No Connection

### Notes

1. All dimensions are in inches (mm)
2. Weight: 0.357 lbs (162 g) approx
3. Weight for -D version: 0.476 lbs (216 g) approx
4. Terminal wire size 1.5 mm<sup>2</sup> max
5. Screw terminal torque 4.5 to 6.2 lb-in (0.5 to 0.7 Nm)
6. Case tolerance: ±0.02 (±0.5)

### Input

Characteristic	Minimum	Typical	Maximum	Units	Notes & Conditions
Input Voltage Range	9		36	VDC	24 V nominal
	18		75	VDC	48 V nominal
Input Current					See Models and Ratings table
Inrush Current				A	
Input Filter	Pi type				
Undervoltage Lockout	On at >9 V. Off <7.5 V				24 V models
	On at >18 V. Off <16.0 V				48 V models
Input Surge			50	VDC	24 V models for 100 ms
			100	VDC	48 V models for 100 ms
Remote On/Off	On: Logic High (3.5-12 V) or open circuit				
	Off: Logic Low (<1.2 V) or short pin 1 to pin 2				

### Output

Characteristic	Minimum	Typical	Maximum	Units	Notes & Conditions
Output Voltage	5.1		48	V	See Models and Ratings table
Initial Set Accuracy		±1	±2	%	
Minimum Load	0			A	No minimum load required
Start Up Delay		50		ms	
Line Regulation		±0.5		%	
Load Regulation		±1		%	0 - 100% load
Transient Response			5	% deviation	Recovery to within 1% in <250 µs for a 50% load change at 0.25 A/µs rate
Ripple & Noise			100 150 200	mV pk-pk	5.1 V model, 20 MHz bandwidth 12 V & 48 V models, 20 MHz bandwidth 48 V model, 20 MHz bandwidth
Short Circuit Protection					Trip & Restart (hiccup mode), auto recovery
Overload Protection		150		%	Trip & Restart (hiccup mode)
Overvoltage Protection		120		%	Zener diode clamp
Temperature Coefficient			0.02	%/°C	

### General

Characteristic	Minimum	Typical	Maximum	Units	Notes & Conditions
Efficiency		90		%	See Models and Ratings table
Isolation	2500			VDC	For 60 s
Isolation Resistance	1000			MΩ	At 500 VDC
Input to Output Capacitance			2400	pF	
Switching Frequency		285		kHz	
Power Density			3.4	W/in <sup>3</sup>	
Mean Time Between Failure	6000			kHrs	MIL-HDBK-217F, +25 °C GB
Weight		0.357 (162)		lb (g)	

### Environmental

Characteristic	Minimum	Typical	Maximum	Units	Notes & Conditions
Operating Temperature	-40		+95	°C	See derating curve
Storage Temperature	-50		+125	°C	
Case Temperature			95	°C	
Thermal Impedance (Case to Ambient)	4.75			°C/W	Natural convection
	3.55				100 LFM
	3.10				200 LFM
	1.95				400 LFM
Humidity	5		95	%RH	Non-condensing
Cooling					Natural convection
Shock	±3 shocks in each plane, total 18 shocks of 30 g : 11 ms halfsine. Conforms to EN60068-2-27 & EN60068-2-47				
Vibration	10-500 Hz at 2 g sweep and endurance at resonance in all 3 planes. Conforms to EN60068-2-6				

### EMC: Emissions

Phenomenon	Standard	Test Level	Notes & Conditions
Conducted	EN55032	Level A	With no external components
Radiated	EN55032	Level A	See application notes

### EMC: Immunity

Phenomenon	Standard	Test Level	Criteria	Notes & Conditions
Immunity	EN55024			
ESD Immunity	EN61000-4-2	±4 kV Contact, ±8 kV Air	A	
Radiated Immunity	EN61000-4-3	10 V/m	A	
EFT/Burst	EN61000-4-4	3	A	
Surges	EN61000-4-5	3	A	
Conducted Immunity	EN61000-4-6	10 Vm	A	
Magnetic Fields	EN61000-4-8	30 A/m	A	

### Safety Approvals

Safety Agency	Safety Standard	Notes & Conditions
CB	IEC60950-1, IEC62368-1	ITE
UL	UL/cUL60950-1, UL/cUL62368-1	ITE

### Application Notes

#### Derating Curve for Convection Cooling

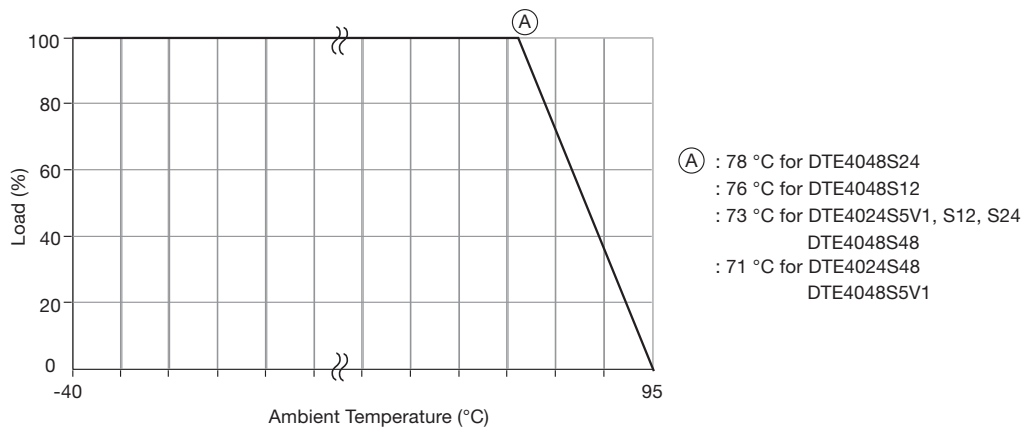

#### Radiated Emissions

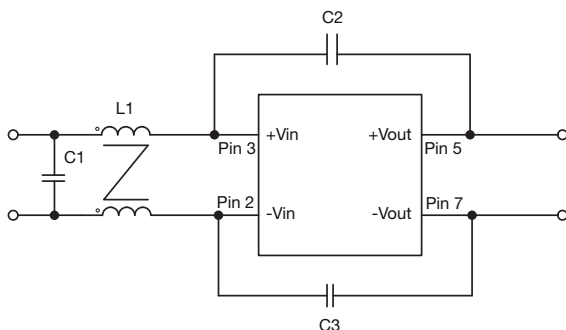

Model	L1	C1	C2	C3
DTE4024SXX	175 µH	4.7 µF/50 V	220 pF/3 KV	220 pF/3 KV
DTE4048SXX	175 µH	3.3 µF/100 V	220 pF/3 KV	220 pF/3 KV

### Mechanical Details

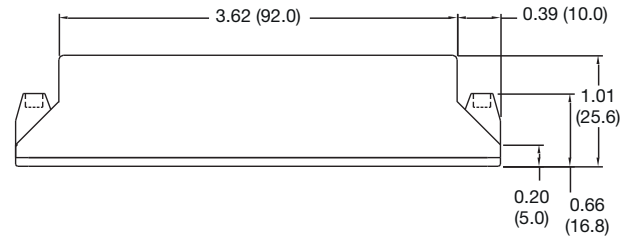
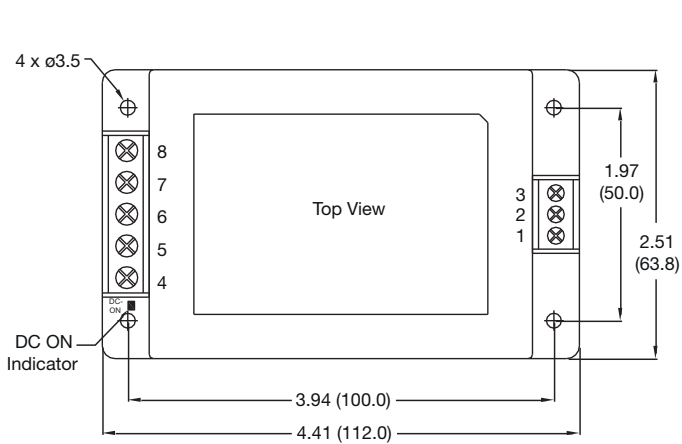

### -D Version

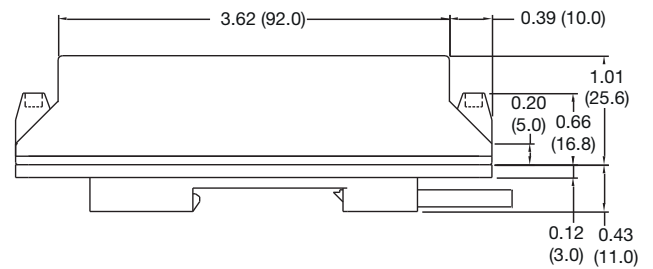

### Notes

- All dimensions are in inches (mm)
- Weight: 0.357 lbs (162 g) approx
- Weight for -D version: 0.476 lbs (216 g) approx
- Terminal wire size 1.5 mm<sup>2</sup> max
- Screw terminal torque 4.5 to 6.2 lb-in (0.5 to 0.7 Nm)
- Case tolerance: ±0.02 (±0.5)

Pin Connections	
Pin	Function
1	Remote On/Off
2	-Vin
3	+Vin
4	+Vout
5	No Connection
6	-Vout
7	No Connection
8	No Connection