

# SFH 4551

## Radial SMR

High Power Infrared Emitter (850nm) in SMR® Package

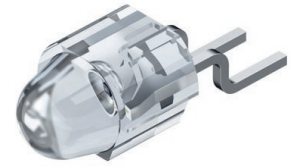

## Applications

- Electronic Equipment
- Highbay Industrial
- Industrial Automation (Machine controls, Light barriers, Vision controls)
- Safety systems and CCTV
- Smoke Detectors
- White Goods

## Features:

- Package: clear epoxy
- ESD: 2 kV acc. to ANSI/ESDA/JEDEC JS-001 (HBM, Class 2)
- High Power Infrared LED
- SMR® (Surface Mount Radial) package
- Same package as photodiode SFH 2500 FA
- Short switching times
- UL version available (ordering code & test conditions on request)

## Ordering Information

Type	Radiant intensity <sup>1)</sup> $I_F = 100 \text{ mA}; t_p = 20 \text{ ms}$ $I_e$	Radiant intensity <sup>1)</sup> typ. $I_F = 100 \text{ mA}; t_p = 20 \text{ ms}$ $I_e$	Ordering Code
SFH 4551	100 ... 500 mW/sr	270 mW/sr	Q65111A0506
SFH 4551-BWCW	160 ... 500 mW/sr	270 mW/sr	Q65112A4144

## Maximum Ratings

$T_A = 25\text{ °C}$

Parameter	Symbol		Values
Operating temperature	$T_{op}$	min. max.	-40 °C 85 °C
Storage temperature	$T_{stg}$	min. max.	-40 °C 85 °C
Reverse voltage <sup>2)</sup>	$V_R$	max.	12 V
Forward current	$I_F$	max.	100 mA
Surge current $t_p \leq 100\ \mu\text{s}; D = 0$	$I_{FSM}$	max.	1 A
Power consumption	$P_{tot}$	max.	180 mW
ESD withstand voltage acc. to ANSI/ESDA/JEDEC JS-001 (HBM, Class 2)	$V_{ESD}$	max.	2 kV

## Characteristics

$I_F = 100 \text{ mA}$ ;  $t_p = 20 \text{ ms}$ ;  $T_A = 25 \text{ °C}$

Parameter	Symbol		Values
Peak wavelength	$\lambda_{\text{peak}}$	typ.	860 nm
Centroid wavelength	$\lambda_{\text{centroid}}$	typ.	850 nm
Spectral bandwidth at 50% $I_{\text{rel,max}}$	$\Delta\lambda$	typ.	30 nm
Half angle	$\varphi$	typ.	10 °
Dimensions of active chip area	L x W	typ.	0.3 x 0.3 mm x mm
Rise time (10% / 90%) $I_F = 100 \text{ mA}$ ; $R_L = 50 \text{ }\Omega$	$t_r$	typ.	12 ns
Fall time (10% / 90%) $I_F = 100 \text{ mA}$ ; $R_L = 50 \text{ }\Omega$	$t_f$	typ.	12 ns
Forward voltage	$V_F$	typ. max.	1.5 V 1.8 V
Forward voltage $I_F = 1 \text{ A}$ ; $t_p = 100 \text{ }\mu\text{s}$	$V_F$	typ. max.	2.4 V 3 V
Reverse current <sup>2)</sup> $V_R = 5 \text{ V}$	$I_R$	max. typ.	10 $\mu\text{A}$ 0.01 $\mu\text{A}$
Total radiant flux <sup>3)</sup>	$\Phi_e$	typ.	70 mW
Radiant intensity <sup>1)</sup> $I_F = 1 \text{ A}$ ; $t_p = 25 \text{ }\mu\text{s}$	$I_e$	typ.	2150 mW/sr
Temperature coefficient of brightness	$TC_I$	typ.	-0.5 % / K
Temperature coefficient of voltage	$TC_V$	typ.	-0.7 mV / K
Temperature coefficient of wavelength	$TC_\lambda$	typ.	0.3 nm / K
Thermal resistance junction ambient real <sup>4)</sup>	$R_{\text{thJA}}$	max.	300 K / W

## Brightness Groups

$T_A = 25\text{ °C}$

Group	Radiant intensity	Radiant intensity
	$I_F = 100\text{ mA}; t_p = 20\text{ ms}$ min. $I_e$	$I_F = 100\text{ mA}; t_p = 20\text{ ms}$ max. $I_e$
AW	100 mW/sr	200 mW/sr
BW	160 mW/sr	320 mW/sr
CW	250 mW/sr	500 mW/sr

Only one group in one packing unit (variation lower 2:1).

## Relative Spectral Emission <sup>5), 6)</sup>

$I_{rel} = f(\lambda); I_F = 100\text{ mA}; t_p = 20\text{ ms}$

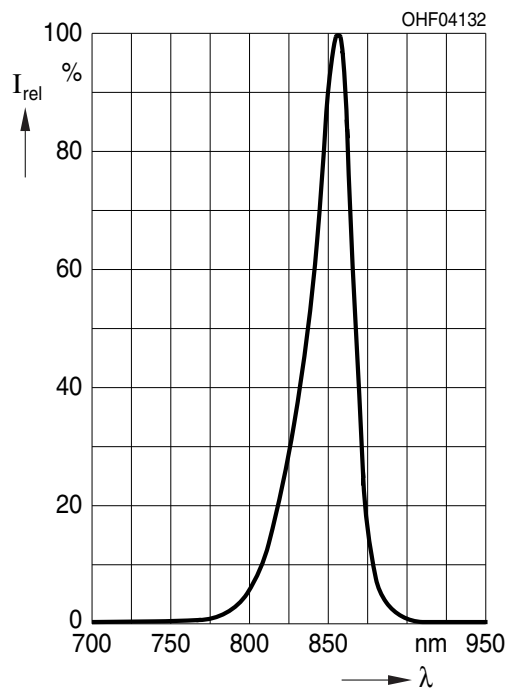

**Radiation Characteristics** 5), 6)

$I_{rel} = f(\varphi)$

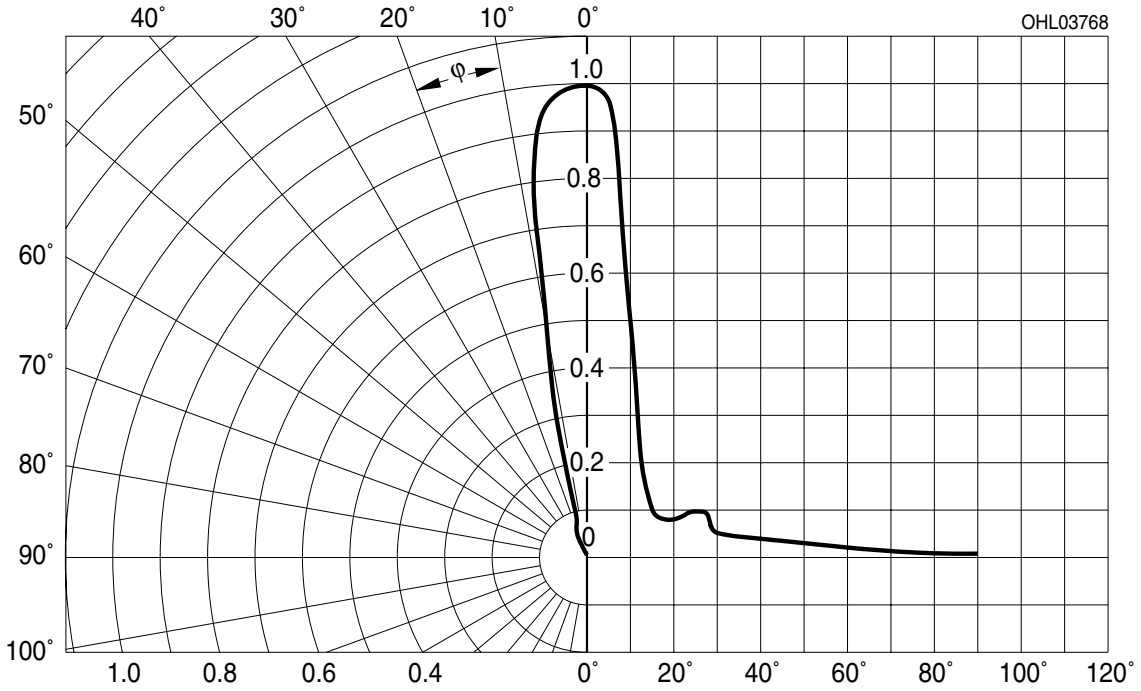

**Forward current** 5), 6)

$I_F = f(V_F)$ ; single pulse;  $t_p = 100 \mu s$

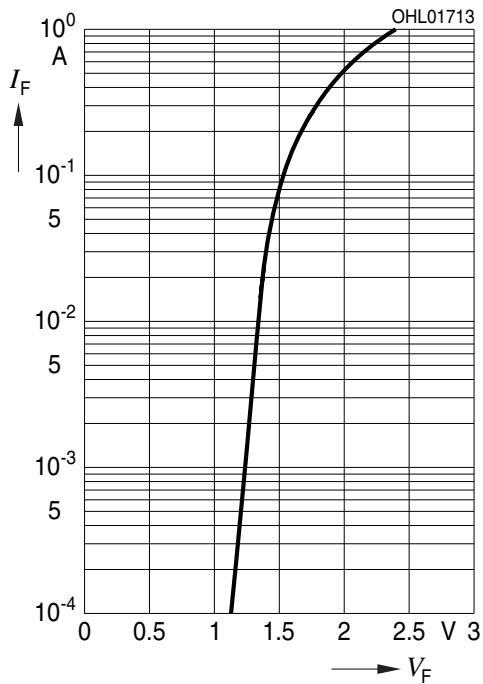

**Radiant Intensity** 5), 6)

$I_e/I_e(100mA) = f(I_F)$ ; single pulse;  $t_p = 25 \mu s$

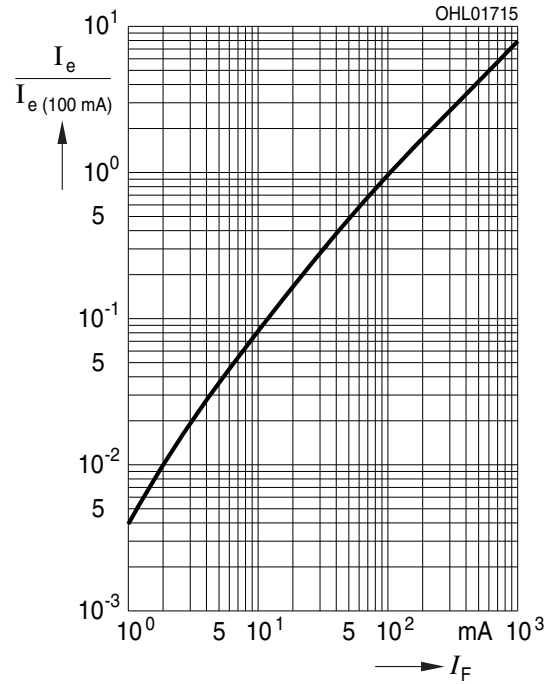

### Max. Permissible Forward Current

$I_{F,max} = f(T_A); R_{thJA} = 300 \text{ K/W}$

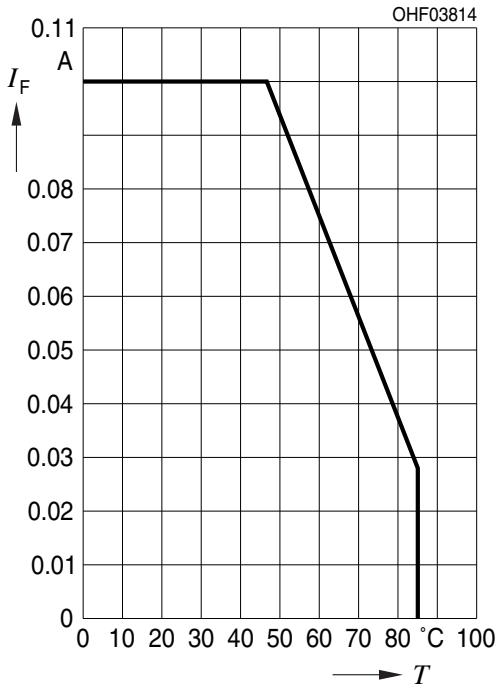

### Permissible Pulse Handling Capability

$I_F = f(t_p); \text{duty cycle } D = \text{parameter}; T_A = 25^\circ\text{C}$

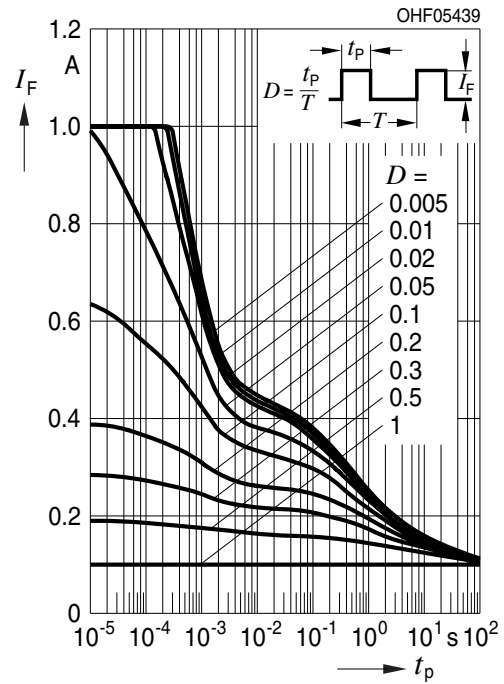

### Permissible Pulse Handling Capability

$I_F = f(t_p); \text{duty cycle } D = \text{parameter}; T_A = 85^\circ\text{C}$

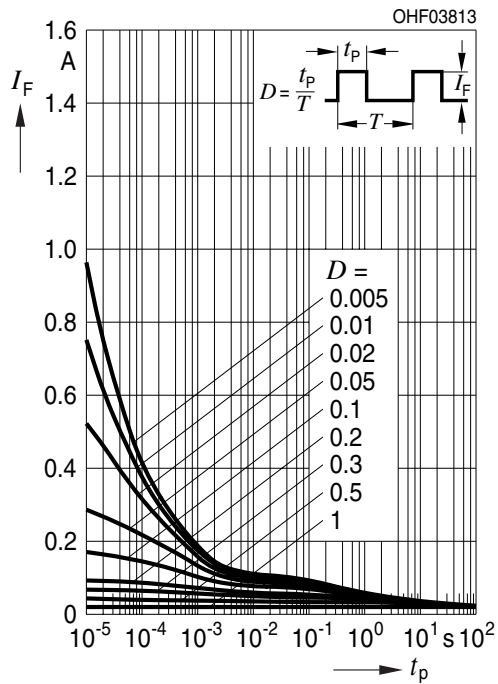

Dimensional Drawing <sup>7)</sup>

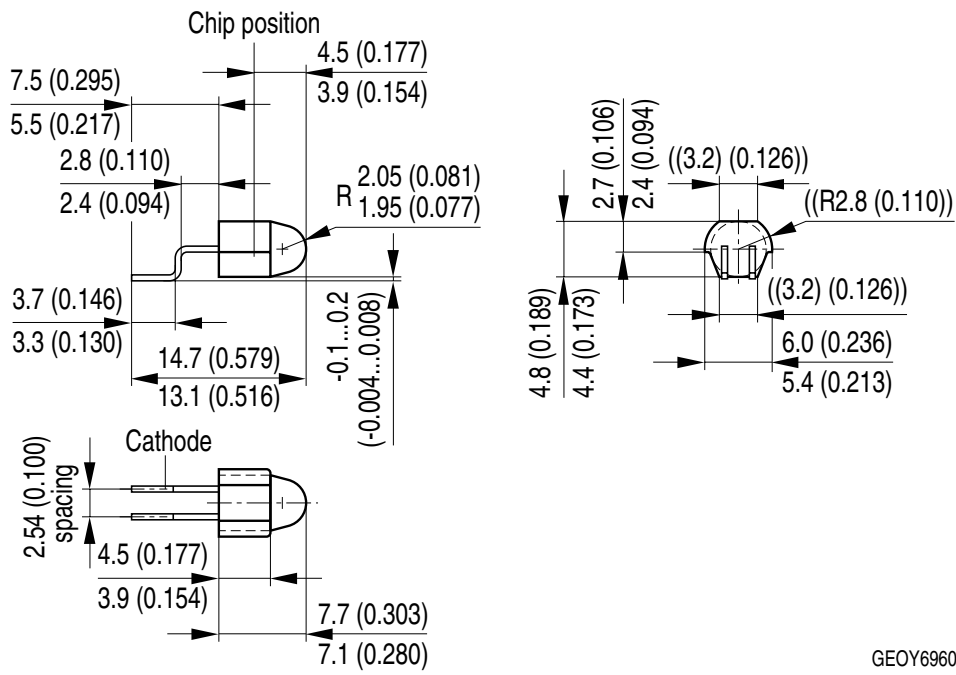

GEOY6960

**Approximate Weight:** 237.0 mg

**Package marking:** Cathode

## Recommended Solder Pad <sup>7)</sup>

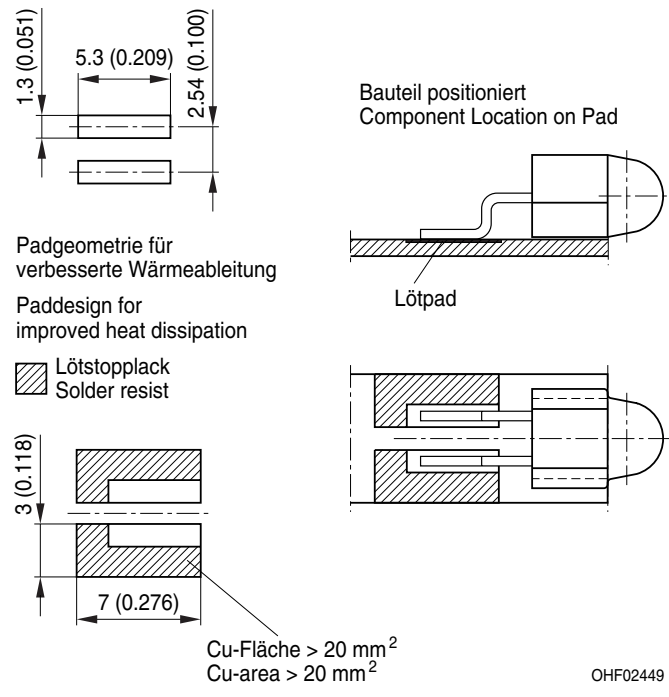

## Reflow Soldering Profile

Product complies to MSL Level 3 acc. to JEDEC J-STD-020E

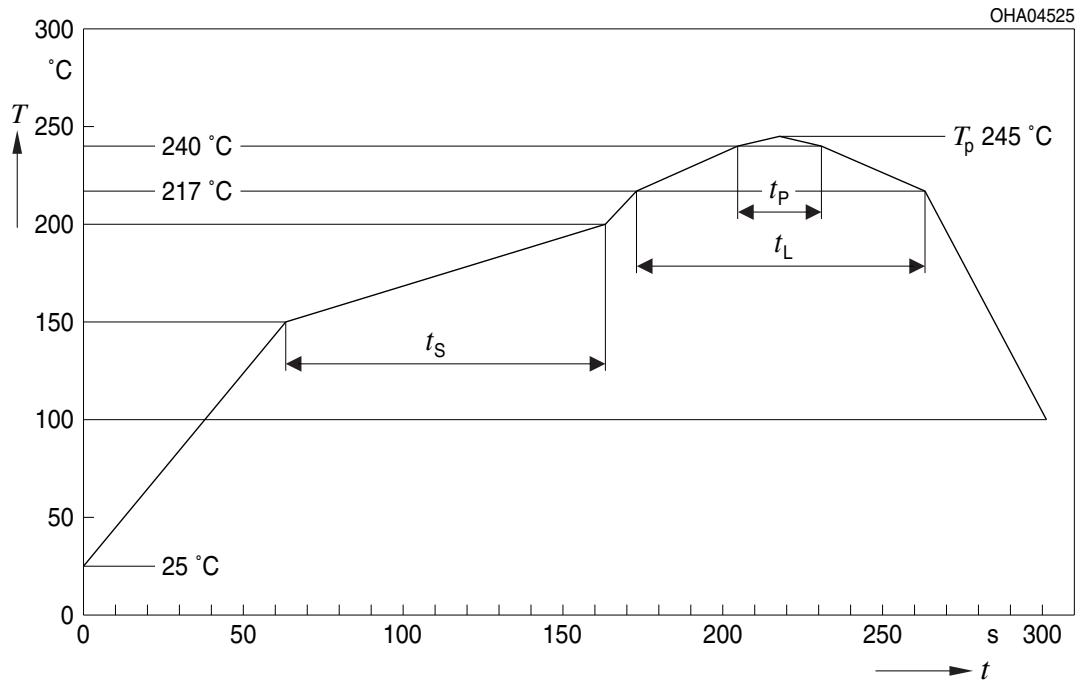



Profile Feature	Symbol	Pb-Free (SnAgCu) Assembly			Unit
		Minimum	Recommendation	Maximum	
Ramp-up rate to preheat*) 25 °C to 150 °C			2	3	K/s
Time $t_s$ $T_{Smin}$ to $T_{Smax}$	$t_s$	60	100	120	s
Ramp-up rate to peak*) $T_{Smax}$ to $T_p$			2	3	K/s
Liquidus temperature	$T_L$		217		°C
Time above liquidus temperature	$t_L$		80	100	s
Peak temperature	$T_p$		245	260	°C
Time within 5 °C of the specified peak temperature $T_p - 5$ K	$t_p$	10	20	30	s
Ramp-down rate* $T_p$ to 100 °C			3	6	K/s
Time 25 °C to $T_p$				480	s

All temperatures refer to the center of the package, measured on the top of the component  
 \* slope calculation  $DT/Dt$ :  $Dt$  max. 5 s; fulfillment for the whole T-range

### Taping <sup>7)</sup>

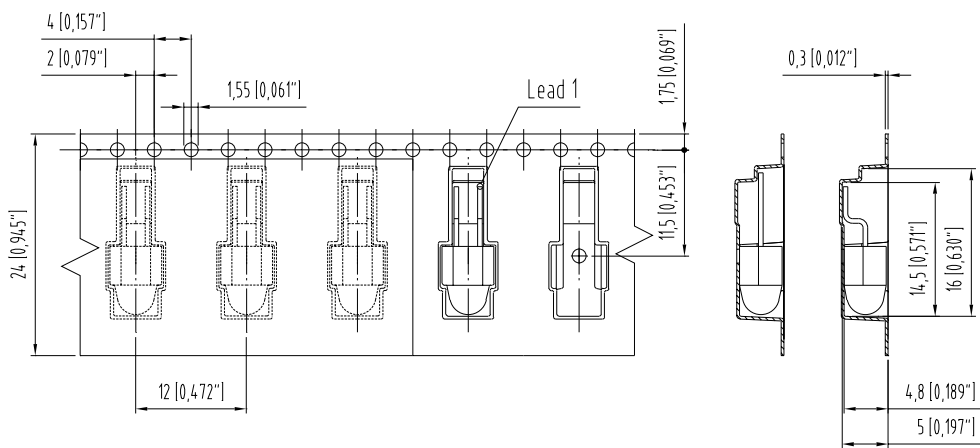

C63062-A3252-B3 -04

**Tape and Reel** <sup>8)</sup>

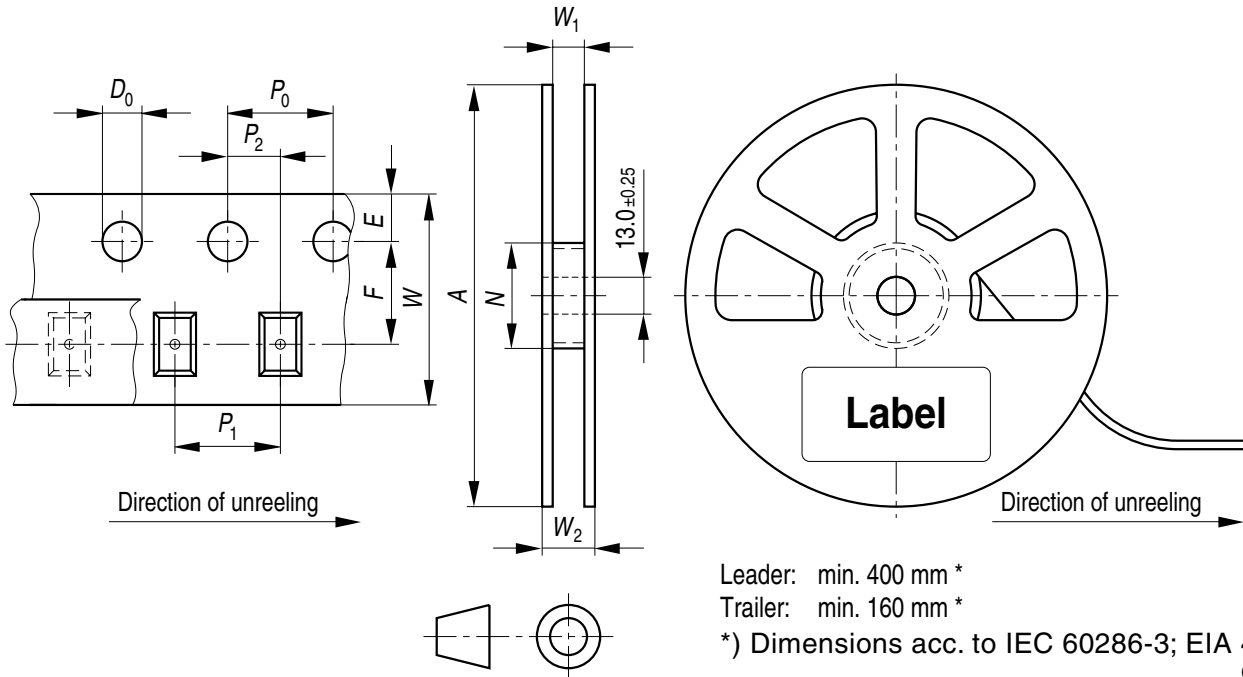

Leader: min. 400 mm \*  
 Trailer: min. 160 mm \*

\*) Dimensions acc. to IEC 60286-3; EIA 481-D  
 OHAY0324

**Reel dimensions [mm]**

A	W	N <sub>min</sub>	W <sub>1</sub>	W <sub>2max</sub>	Pieces per PU
330 mm	24 + 0.3 / - 0.1	60/100	24.4 + 2	30.4	1000

## Barcode-Product-Label (BPL)



## Dry Packing Process and Materials <sup>7)</sup>



Moisture-sensitive product is packed in a dry bag containing desiccant and a humidity card according JEDEC-STD-033.

## Transportation Packing and Materials <sup>7)</sup>

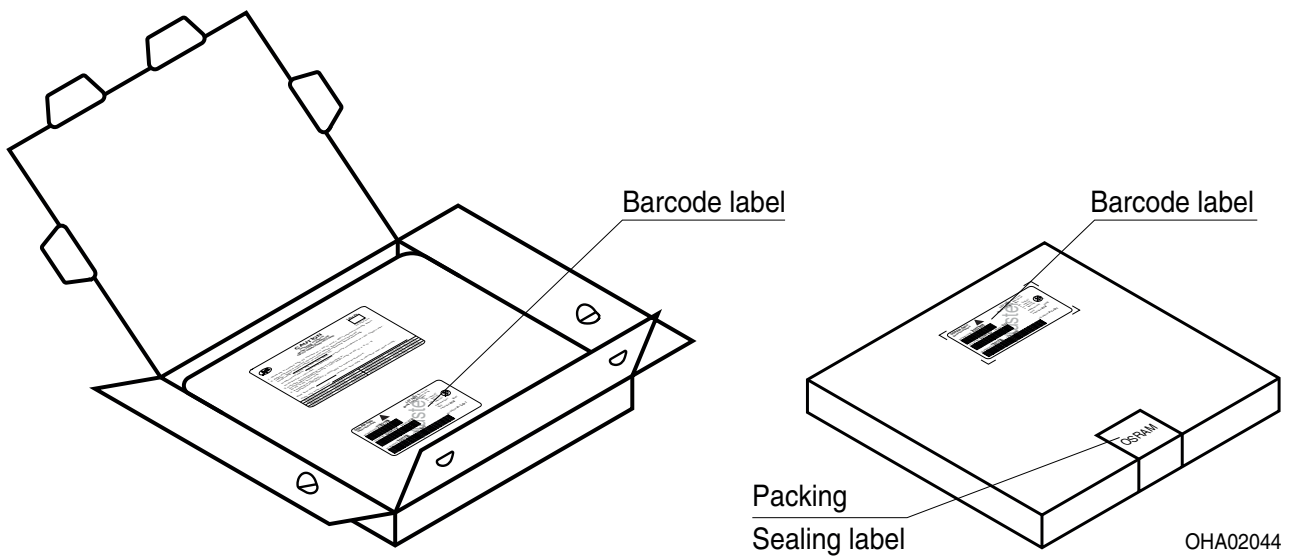

### Dimensions of transportation box in mm

Width	Length	Height
349 ± 5 mm	349 ± 5 mm	38 ± 5 mm

## Notes

The evaluation of eye safety occurs according to the standard IEC 62471:2006 (photo biological safety of lamps and lamp systems). Within the risk grouping system of this IEC standard, the LED specified in this data sheet fall into the class **exempt group (exposure time 10000 s)**. Under real circumstances (for exposure time, eye pupils, observation distance), it is assumed that no endangerment to the eye exists from these devices. As a matter of principle, however, it should be mentioned that intense light sources have a high secondary exposure potential due to their blinding effect. As is also true when viewing other bright light sources (e.g. headlights), temporary reduction in visual acuity and afterimages can occur, leading to irritation, annoyance, visual impairment, and even accidents, depending on the situation.

For further application related informations please visit [www.osram-os.com/apnotes](http://www.osram-os.com/apnotes)

## Disclaimer

### Disclaimer

Language english will prevail in case of any discrepancies or deviations between the two language wordings.

### Attention please!

The information describes the type of component and shall not be considered as assured characteristics. Terms of delivery and rights to change design reserved. Due to technical requirements components may contain dangerous substances.

For information on the types in question please contact our Sales Organization.

If printed or downloaded, please find the latest version in the OSRAM OS Website.

### Packing

Please use the recycling operators known to you. We can also help you – get in touch with your nearest sales office.

By agreement we will take packing material back, if it is sorted. You must bear the costs of transport. For packing material that is returned to us unsorted or which we are not obliged to accept, we shall have to invoice you for any costs incurred.

### Product safety devices/applications or medical devices/applications

OSRAM OS components are not developed, constructed or tested for the application as safety relevant component or for the application in medical devices.

In case Buyer – or Customer supplied by Buyer– considers using OSRAM OS components in product safety devices/applications or medical devices/applications, Buyer and/or Customer has to inform the local sales partner of OSRAM OS immediately and OSRAM OS and Buyer and /or Customer will analyze and coordinate the customer-specific request between OSRAM OS and Buyer and/or Customer.

---

## Glossary

- 1) **Radiant intensity:** Measured at a solid angle of  $\Omega = 0.01$  sr
- 2) **Reverse Operation:** Reverse Operation of 10 hours is permissible in total. Continuous reverse operation is not allowed.
- 3) **Total radiant flux:** Measured with integrating sphere.
- 4) **Thermal resistance:** junction - ambient, mounted on PC-board (FR4), padsize 20 mm<sup>2</sup> each
- 5) **Typical Values:** Due to the special conditions of the manufacturing processes of LED, the typical data or calculated correlations of technical parameters can only reflect statistical figures. These do not necessarily correspond to the actual parameters of each single product, which could differ from the typical data and calculated correlations or the typical characteristic line. If requested, e.g. because of technical improvements, these typ. data will be changed without any further notice.
- 6) **Testing temperature:**  $T_A = 25^\circ\text{C}$
- 7) **Tolerance of Measure:** Unless otherwise noted in drawing, tolerances are specified with  $\pm 0.1$  and dimensions are specified in mm.
- 8) **Tape and Reel:** All dimensions and tolerances are specified acc. IEC 60286-3 and specified in mm.

Published by OSRAM Opto Semiconductors GmbH EU RoHS and China RoHS compliant product  
Leibnizstraße 4, D-93055 Regensburg  
www.osram-os.com © All Rights Reserved.



此产品符合欧盟 RoHS 指令的要求；  
按照中国的相关法规和标准，不含有毒有害物质或元素。