

# SFH 2700 FA

## CHIPLED®

Silicon PIN Photodiode

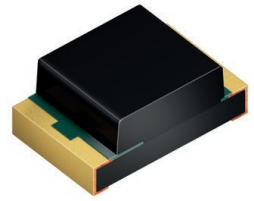

### Applications

- Industrial Automation (Machine Controls, Light Barriers, Vision Controls)

### Features:

- Package: black epoxy
- ESD: 2 kV acc. to ANSI/ESDA/JEDEC JS-001 (HBM, Class 2)
- Very small SMT package
- Especially suitable for applications from 700 nm to 1100 nm

### Ordering Information

Type	Photocurrent $E_e = 0.5 \text{ mW/cm}^2; \lambda = 850 \text{ nm}; V_R = 5 \text{ V}$ $I_P$	Photocurrent typ. $E_e = 0.5 \text{ mW/cm}^2; \lambda = 850 \text{ nm}; V_R = 5 \text{ V}$ $I_P$	Ordering Code
SFH 2700 FA	$\geq 1.2 \mu\text{A}$	$1.5 \mu\text{A}$	Q65112A4434

## Maximum Ratings

Parameter	Symbol		Values
Operating Temperature	$T_{op}$	min.	-40 °C
		max.	100 °C
Storage temperature	$T_{stg}$	min.	-40 °C
		max.	100 °C
Reverse voltage	$V_R$	max.	16 V
ESD withstand voltage acc. to ANSI/ESDA/JEDEC JS-001 (HBM, Class 2)	$V_{ESD}$	max.	2 kV

## Characteristics

$T_A = 25\text{ °C}$

Parameter	Symbol		Values
Wavelength of max sensitivity	$\lambda_{S\ max}$	typ.	890 nm
Spectral range of sensitivity	$\lambda_{10\%}$	typ.	700 ... 1100 nm
Radiant sensitive area	A	typ.	0.35 mm <sup>2</sup>
Dimensions of active chip area	L x W	typ.	0.59 x 0.59 mm x mm
Half angle	$\varphi$	typ.	70 °
Dark current	$I_R$	typ.	0.045 nA
$V_R = 5\text{ V}$		max.	5 nA
Open-circuit voltage	$V_O$	min.	290 mV
$E_e = 0.5\text{ mW/cm}^2$ ; $\lambda = 850\text{ nm}$		typ.	300 mV
Short-circuit current	$I_{SC}$	typ.	1.4 $\mu$ A
$E_e = 0.5\text{ mW/cm}^2$ ; $\lambda = 850\text{ nm}$			
Rise time	$t_r$	typ.	0.12 $\mu$ s
$V_R = 5\text{ V}$ ; $R_L = 50\ \Omega$ ; $\lambda = 850\text{ nm}$			
Fall time	$t_f$	typ.	0.12 $\mu$ s
$V_R = 5\text{ V}$ ; $R_L = 50\ \Omega$ ; $\lambda = 850\text{ nm}$			
Forward voltage	$V_F$	typ.	0.8 V
$I_F = 5\text{ mA}$			
Capacitance	$C_0$	typ.	4.6 pF
$V_R = 0\text{ V}$ ; $f = 1\text{ MHz}$ ; $E = 0$			

### Relative Spectral Sensitivity <sup>1), 2)</sup>

$$S_{rel} = f(\lambda)$$

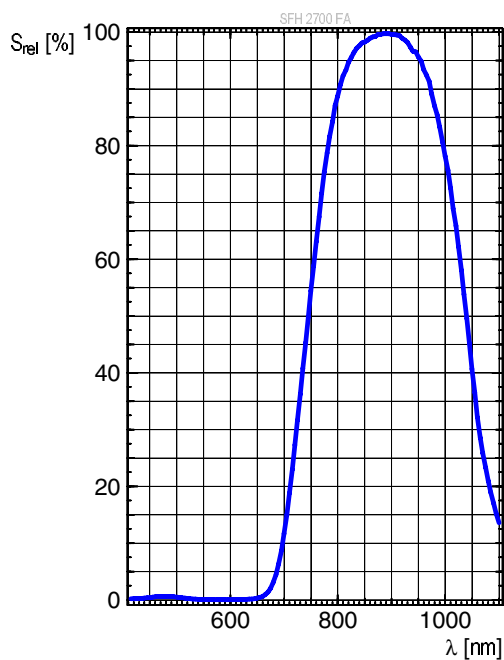

### Directional Characteristics <sup>1), 2)</sup>

$$S_{rel} = f(\varphi)$$

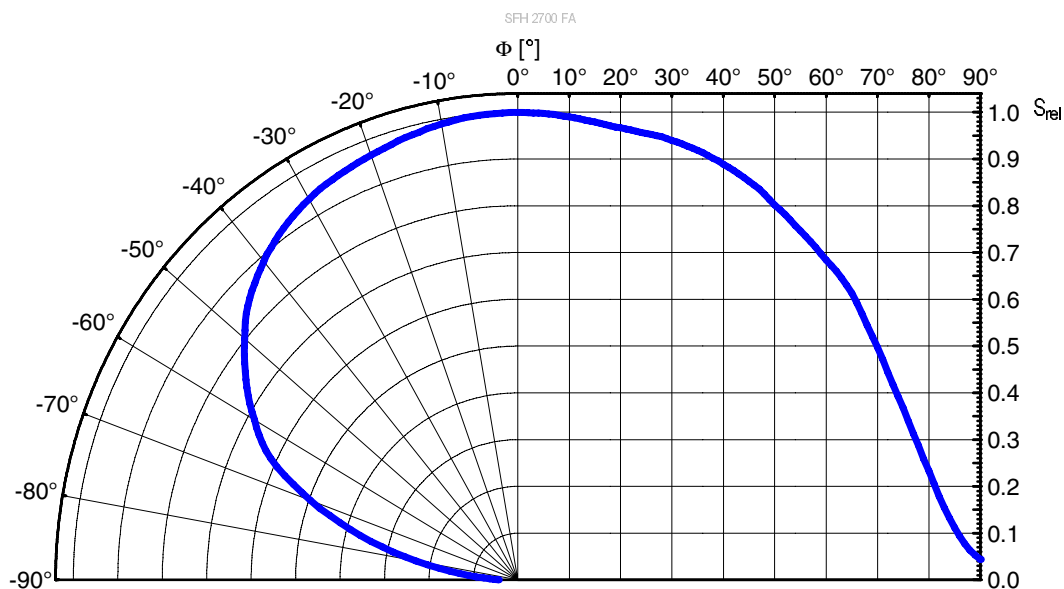

**Photocurrent** <sup>1), 2)</sup>

$I_p = f(E_e); \lambda = 850 \text{ nm}; V_R = 5 \text{ V}$

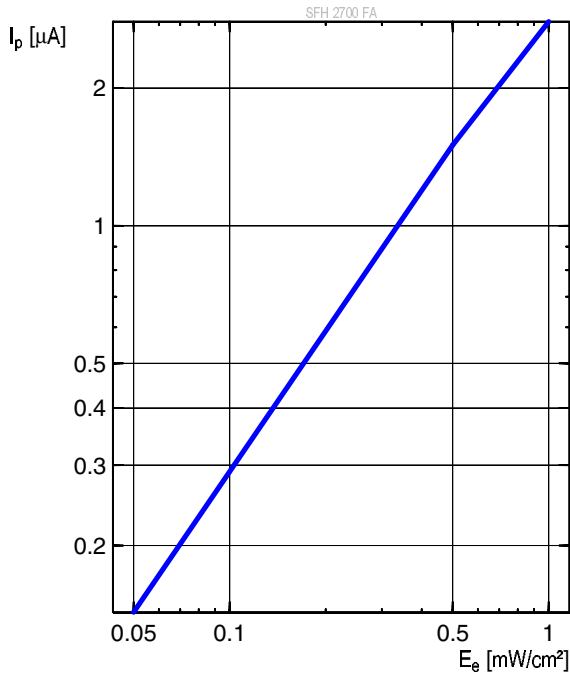

**Dark Current** <sup>1), 2)</sup>

$I_R = f(V_R); E = 0$

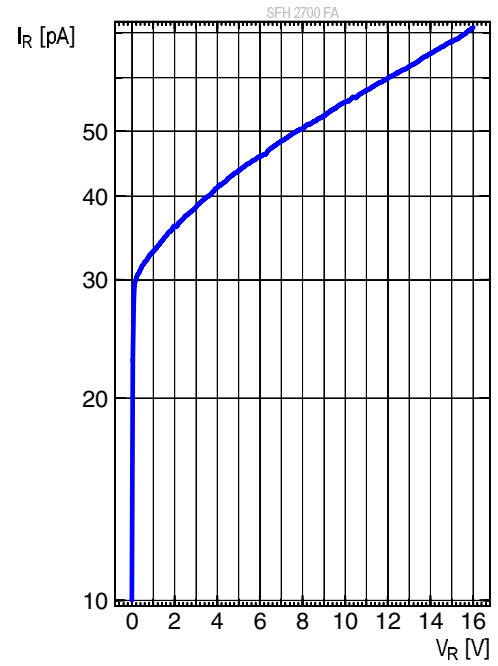

**Capacitance** <sup>1), 2)</sup>

$C = f(V_R); f = 1 \text{ MHz}; E = 0;$

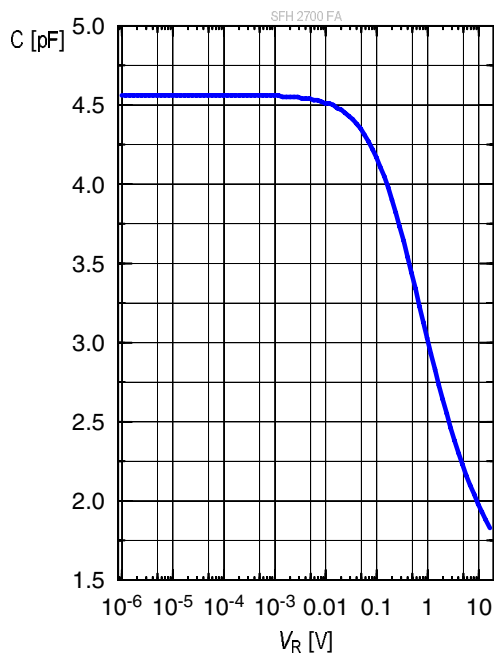

## Dimensional Drawing <sup>3)</sup>

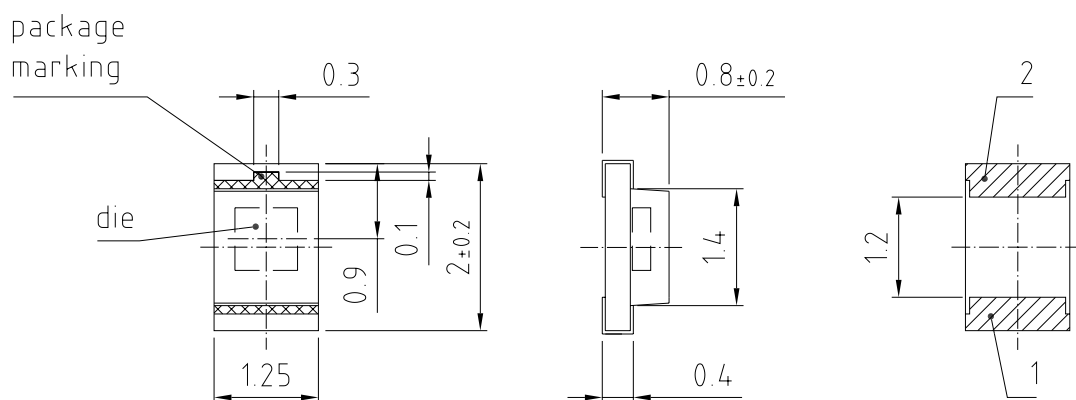

general tolerance  $\pm 0.1$   
lead finish Au 

C67062-A0256-A1..-02

**Approximate Weight:** 3.8 mg  
**Package marking:** Cathode

Pin	Description
1	Anode
2	Cathode

### Recommended Solder Pad <sup>3)</sup>

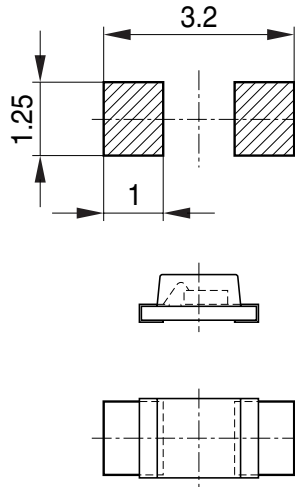

Bauteil positioniert  
Component location on pad

OHFP2578

### Reflow Soldering Profile

Product complies to MSL Level 3 acc. to JEDEC J-STD-020E

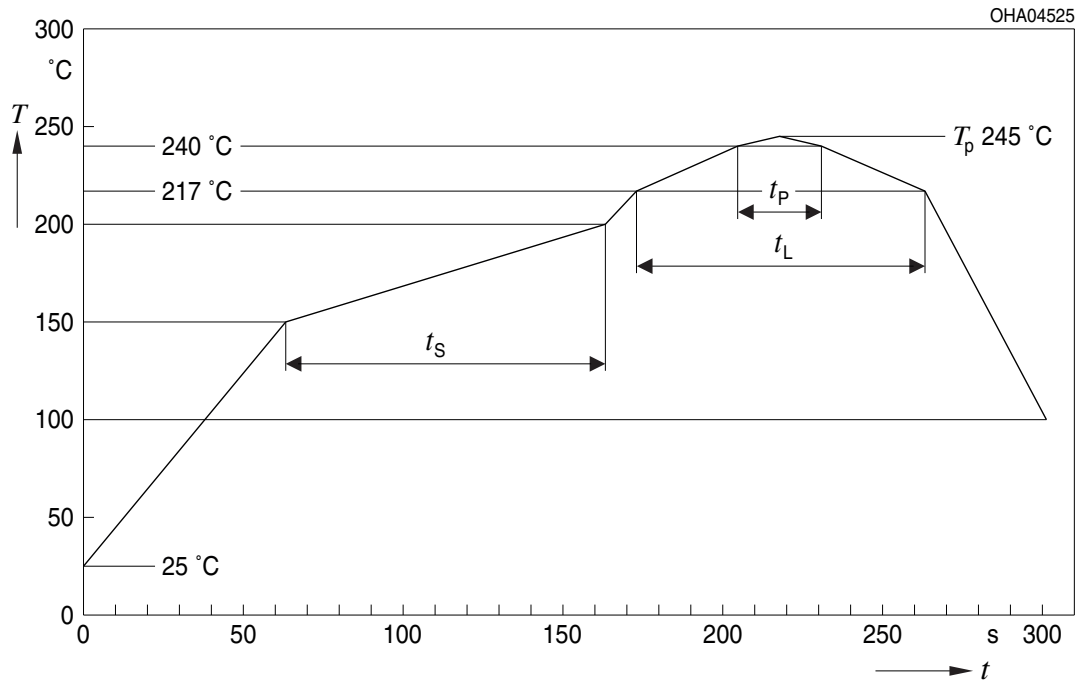

Profile Feature	Symbol	Pb-Free (SnAgCu) Assembly			Unit
		Minimum	Recommendation	Maximum	
Ramp-up rate to preheat <sup>*)</sup> 25 °C to 150 °C			2	3	K/s
Time $t_s$ $T_{Smin}$ to $T_{Smax}$	$t_s$	60	100	120	s
Ramp-up rate to peak <sup>*)</sup> $T_{Smax}$ to $T_p$			2	3	K/s
Liquidus temperature	$T_L$		217		°C
Time above liquidus temperature	$t_L$		80	100	s
Peak temperature	$T_p$		245	260	°C
Time within 5 °C of the specified peak temperature $T_p - 5$ K	$t_p$	10	20	30	s
Ramp-down rate* $T_p$ to 100 °C			3	6	K/s
Time 25 °C to $T_p$				480	s

All temperatures refer to the center of the package, measured on the top of the component

\* slope calculation  $DT/Dt$ :  $Dt$  max. 5 s; fulfillment for the whole T-range

**Taping** <sup>3)</sup>

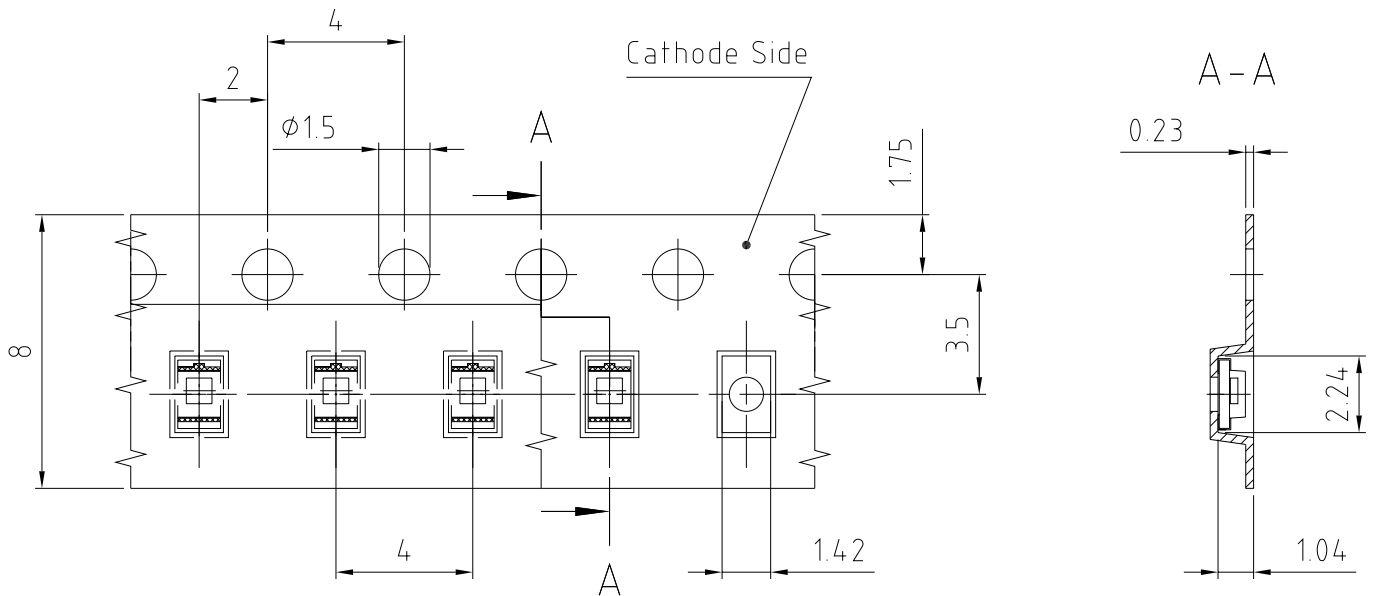

C67062-A0256-B1-02

**Tape and Reel** <sup>4)</sup>

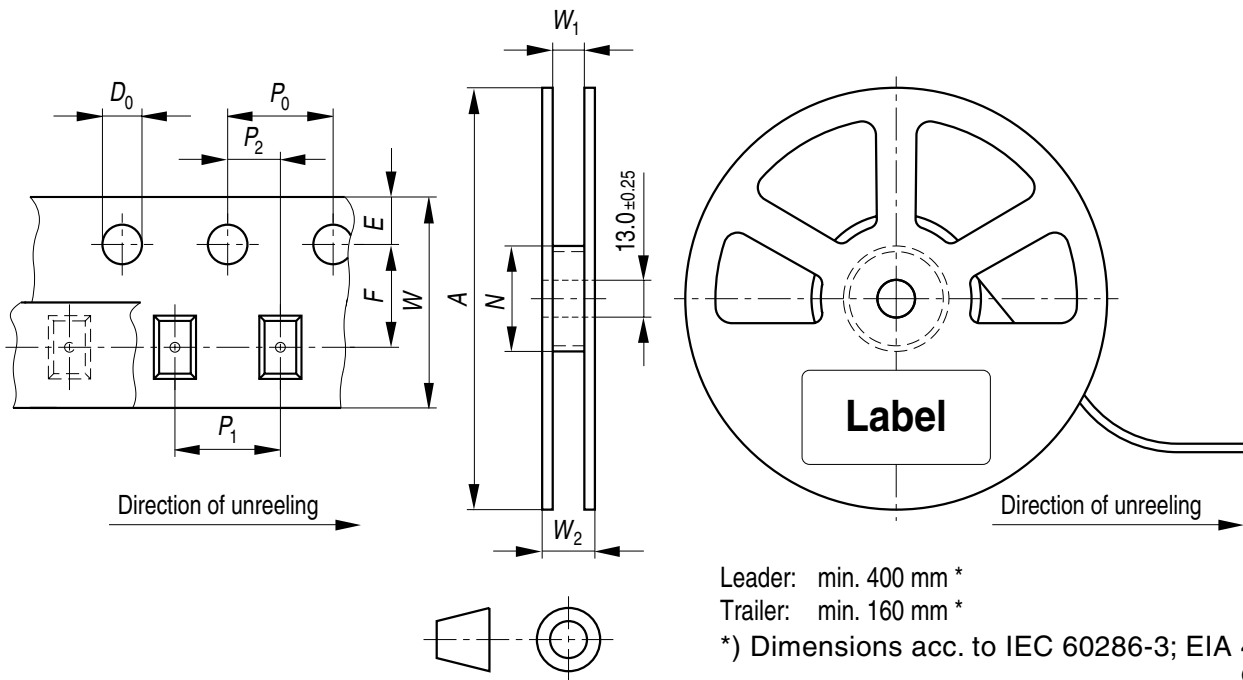

Leader: min. 400 mm \*  
 Trailer: min. 160 mm \*

\*) Dimensions acc. to IEC 60286-3; EIA 481-D  
 OHAY0324

**Reel dimensions [mm]**

A	W	N <sub>min</sub>	W <sub>1</sub>	W <sub>2 max</sub>	Pieces per PU
180 mm	8 + 0.3 / - 0.1	60	8.4 + 2	14.4	3000



## Barcode-Product-Label (BPL)

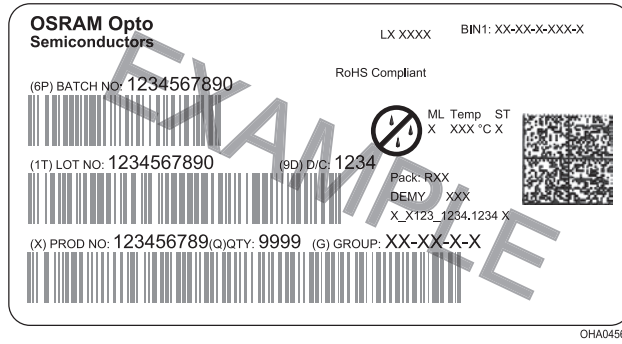

## Dry Packing Process and Materials <sup>3)</sup>

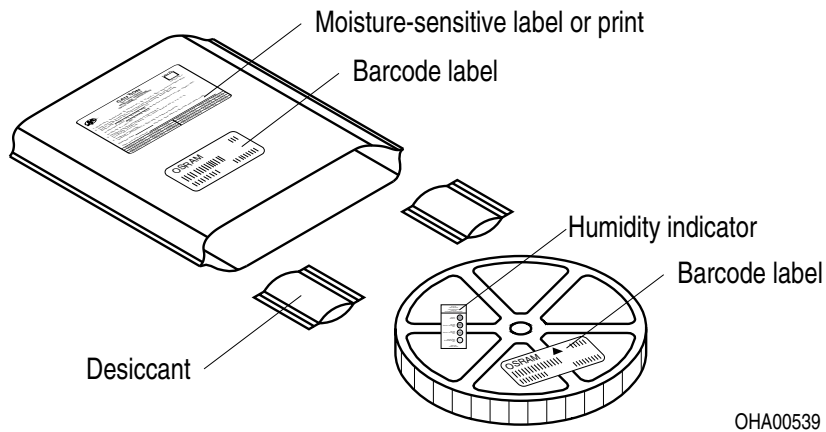

Moisture-sensitive product is packed in a dry bag containing desiccant and a humidity card according JEDEC-STD-033.

## Transportation Packing and Materials <sup>3)</sup>

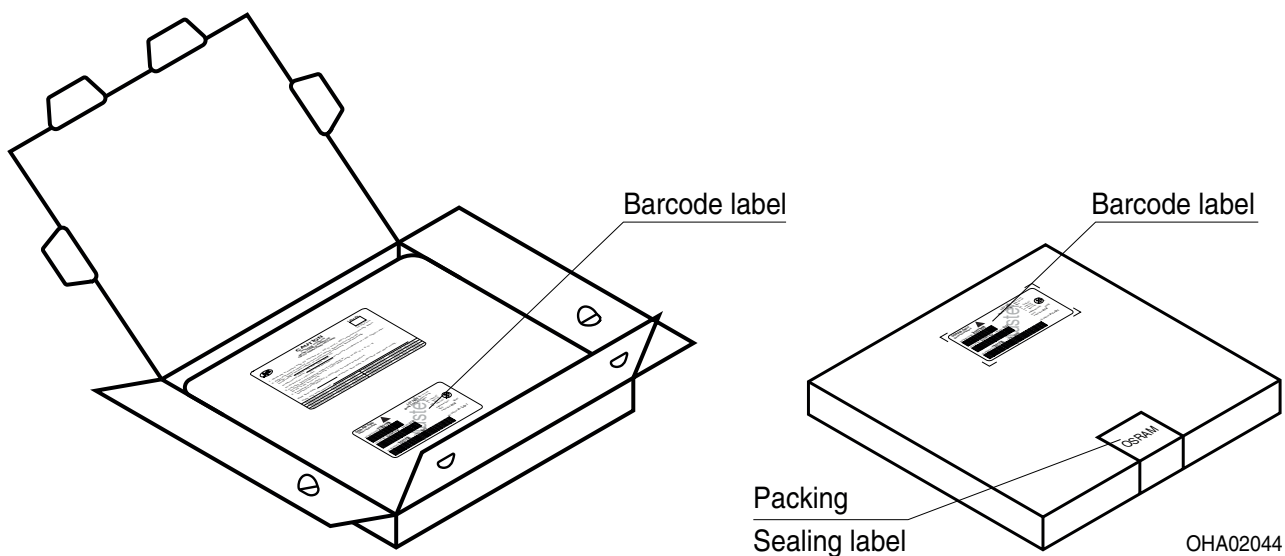

### Dimensions of transportation box in mm

Width	Length	Height
200 ± 5 mm	195 ± 5 mm	30 ± 5 mm

## Notes

The evaluation of eye safety occurs according to the standard IEC 62471:2006 (photo biological safety of lamps and lamp systems). Within the risk grouping system of this IEC standard, the device specified in this data sheet falls into the class **exempt group (exposure time 10000 s)**. Under real circumstances (for exposure time, conditions of the eye pupils, observation distance), it is assumed that no endangerment to the eye exists from these devices. As a matter of principle, however, it should be mentioned that intense light sources have a high secondary exposure potential due to their blinding effect. When looking at bright light sources (e.g. headlights), temporary reduction in visual acuity and afterimages can occur, leading to irritation, annoyance, visual impairment, and even accidents, depending on the situation.

Subcomponents of this device contain, in addition to other substances, metal filled materials including silver. Metal filled materials can be affected by environments that contain traces of aggressive substances. Therefore, we recommend that customers minimize device exposure to aggressive substances during storage, production, and use. Devices that showed visible discoloration when tested using the described tests above did show no performance deviations within failure limits during the stated test duration. Respective failure limits are described in the IEC60810.

For further application related informations please visit [www.osram-os.com/appnotes](http://www.osram-os.com/appnotes)

## Disclaimer

### Disclaimer

Language english will prevail in case of any discrepancies or deviations between the two language wordings.

### Attention please!

The information describes the type of component and shall not be considered as assured characteristics. Terms of delivery and rights to change design reserved. Due to technical requirements components may contain dangerous substances.

For information on the types in question please contact our Sales Organization.

If printed or downloaded, please find the latest version in the OSRAM OS Website.

### Packing

Please use the recycling operators known to you. We can also help you – get in touch with your nearest sales office.

By agreement we will take packing material back, if it is sorted. You must bear the costs of transport. For packing material that is returned to us unsorted or which we are not obliged to accept, we shall have to invoice you for any costs incurred.

### Product safety devices/applications or medical devices/applications

OSRAM OS components are not developed, constructed or tested for the application as safety relevant component or for the application in medical devices.

In case Buyer – or Customer supplied by Buyer– considers using OSRAM OS components in product safety devices/applications or medical devices/applications, Buyer and/or Customer has to inform the local sales partner of OSRAM OS immediately and OSRAM OS and Buyer and /or Customer will analyze and coordinate the customer-specific request between OSRAM OS and Buyer and/or Customer.

## Glossary

- 1) **Typical Values:** Due to the special conditions of the manufacturing processes of semiconductor devices, the typical data or calculated correlations of technical parameters can only reflect statistical figures. These do not necessarily correspond to the actual parameters of each single product, which could differ from the typical data and calculated correlations or the typical characteristic line. If requested, e.g. because of technical improvements, these typ. data will be changed without any further notice.
- 2) **Testing temperature:**  $T_A = 25^\circ\text{C}$
- 3) **Tolerance of Measure:** Unless otherwise noted in drawing, tolerances are specified with  $\pm 0.1$  and dimensions are specified in mm.
- 4) **Tape and Reel:** All dimensions and tolerances are specified acc. IEC 60286-3 and specified in mm.

Published by OSRAM Opto Semiconductors GmbH EU RoHS and China RoHS compliant product  
Leibnizstraße 4, D-93055 Regensburg  
www.osram-os.com © All Rights Reserved.



此产品符合欧盟 RoHS 指令的要求；  
按照中国的相关法规和标准，不含有毒有害物质或元素。