

LED-Anzeigesysteme

LED Display Systems

In die Entwicklung dieser Bausteine ist das über Jahrzehnte erworbene Know-how der Firma MENTOR als Entwickler und Lieferant von Bauelementen für die Industrieelektronik geflossen. Die Bauelementen-Vielfalt erstreckt sich von THT-Einzelanzeigen in unterschiedlichsten Ausführungen über THT-LED-Leisten, Flächenausleuchtssystemen, Signallampen bis hin zu Lampenfassungen. THT-Ausführungen kennzeichnen Bauteile in Durchstecktechnik.

Der Einsatz dieser Bausteine ist überall dort zu suchen, wo Licht flimmert, strahlt oder blinkt, wo Lichtsignale auf Funktionen oder Betriebszustände aufmerksam machen sollen und müssen.

Den sich ständig verändernden Anforderungen unserer Kunden begegnen wir mit Kompetenz und Innovationskraft und der sich daraus ergebenden Möglichkeit, neben Standardlösungen auch spezielle Kundenwünsche zu erfüllen.

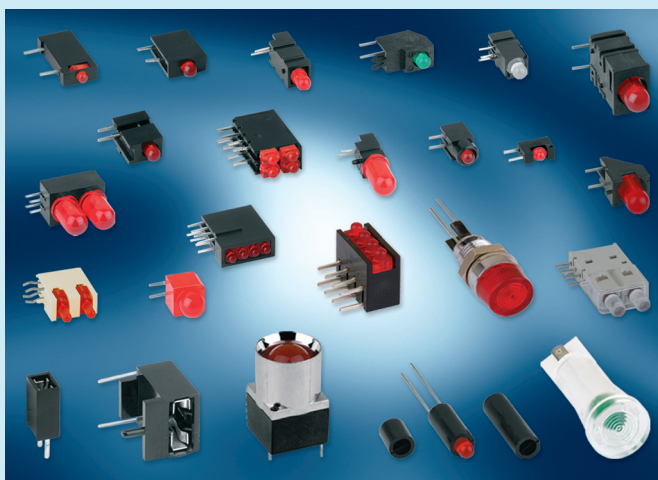

The development of these components benefited from decades of experience gained by MENTOR in developing and supplying components for industrial electronics. The range of components stretches from individual THT displays in various versions via THT LED bars, surfaces made from illumination systems, and signaling lamps all the way to lamp sockets. THT versions designate components in hole-mounted technology.

The area of application of these components covers any scenario where light flickers, radiates or flashes where light signals should and must draw attention to functions or operating status.

We meet our customer's constantly changing demands with competency and innovative energy, thus being able to fulfil not only standard solutions but also to meet customer specific requirements.

Allgemeine technische Daten	(Auswahl bzw. Abweichungen zu den folgenden allgem. Daten: siehe Beschreibung des jeweiligen Artikels)
Lötbarkeit	DIN IEC 68-2-20 (260°C ≤ 5s)
Anschlüsse	verzinkt
Betriebstemperatur	-40°C ... +85°C
Klima	GPF DIN 40040
Beschriftung	auf Sonderwunsch bedruckt oder gelasert
Bestückung mit LED's	Technische Daten siehe Seite 65/66
Sonderwünsche	Sonderbestückung, Verwendung von zusätzlichen Fixierpins sowie umgekehrte Polarität auf Anfrage möglich.
Mindestbestellmengen für Sonderausführungen auf Anfrage.	

General Technical Data	(Selection and deviations from the following general data: see description of the respective item)
Solderability	DIN IEC 68-2-20 (260°C ≤ 5s)
Terminals	tinned
Operatin temperature	-40°C ... +85°C
Climate	GPF DIN 40040
Marking	On special request printed or laser printed
LED's	Technical data see page 65/66
Special requirements	Special components, use of additional fixing pins and reverse polarity on request
Minimum quantity for special design on request.	

Ø2mm Doppel-LED's liegend

Ø2mm Double LEDs horizontal

Allgemeine Hinweise und Technische Daten

Allgemeine Hinweise und technische Daten: siehe Seite 4
Technische Daten LED's: siehe Seite 53/54

General Remarks and Technical Data

General remarks and technical data: see page 4
Technical data LEDs: see page 53/54

Spezifische Technische Daten

Gehäusewerkstoff: PC UL94-V0 beige
ESD-fest gegen Front <12kV (DIN IEC 801-2/VDE 0843T2)

Specific Technical Data

Housing Material: PC UL94-V0 beige
ESD to front <12kV (DIN IEC 801-2/VDE 0843T2)

Dieser Baustein ist im Raster 5mm anreihbar. Seine Besonderheit sind die abgewinkelten Anschlüsse, um ein Rasten und einen Festsitz in der Leiterkarte zu ermöglichen.

This component can be installed in series on a 5mm grid. Its special feature is the angled connections that allow locking and a tight fit on the printed circuit board.

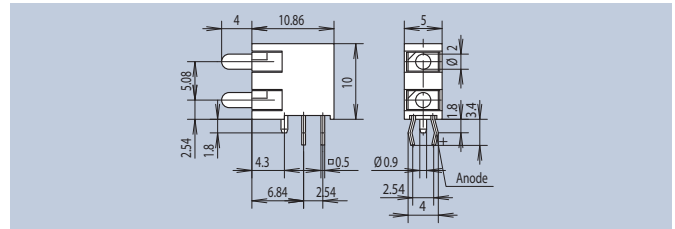
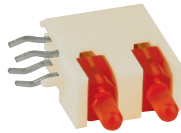

Farbe · Color	LED-Type	Art.-Nr.
	super-red	K1
	yellow	K2
	green	K3

Ø2mm 4-fach-LED's liegend

Ø2mm 4-fold LEDs horizontal

Spezifische Technische Daten

Gehäusewerkstoff: PC UL94 schwarz

Specific Technical Data

Housing Material: PC UL94 black

Dieser Baustein mit vier übereinander angeordneten LED's ist anreihbar.

This component, with four LEDs placed above each other, can be installed in

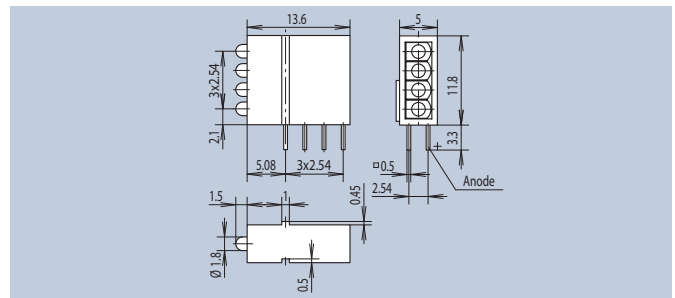
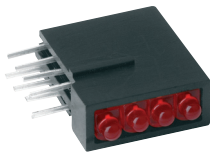

Farbe · Color	LED-Type	Art.-Nr.
	bright red	A22
	yellow	A23
	green	A24

Der Baustein mit 4 übereinander angeordneten Duo-LED's ist im Raster 5mm anreihbar. Wegen möglicher Überstrahlung ist das Bauteil mit und ohne Blende lieferbar, wobei die Blende links und rechts angeordnet sein kann.

This component with four Duo LEDs placed above each other can be installed in series on a 5mm grid. Due to possible irradiation the component can be supplied with or without an aperture. This aperture may be located to the left or to the

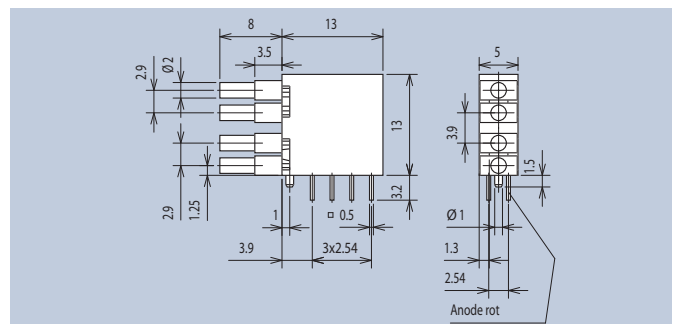
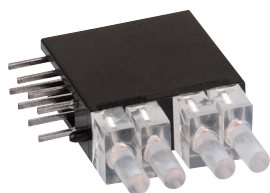

Farbe · Color	LED-Type	Blende · Aperture	Art.-Nr.
	A76	-	2820.2831
	A76	rechts · right	2820.2832
	A76	links · left	2820.2833

ohne Blende · without aperture

Technische Daten THT LED's

Technical Data THT LEDs

LED-Type	Emission Color	Wavelength λ (nm) dominant	Lense Color	Forward Voltage V_F (V)		Luminous Intensity I_V (mcd)			at mA	Fwd. Current I_F max (mA)	Rev. Voltage V_R (V)	2 ϕ (50% I_V) deg.
				typ	max	min	typ	max				
THT												
A 1	red	660	red diffused	2,25	2,5	1	3	-	20 10	25	5	60
A 2	high efficiency red	625	red diffused	2	2,5	8	20	-	20 10	30	5	60
A 3	yellow	588	yellow diffused	2,1	2,5	5	15	-	20 10	30	5	60
A 4	green	568	green diffused	2,2	2,5	8	20	-	20 10	25	5	60
A 5	bright red	660	red diffused	2,25	2,5	1,8	5	-	20 10	25	5	60
A 6	high efficiency red	625	red diffused	2	2,5	8	45	-	20 10	30	5	60
A 7	yellow	588	yellow diffused	2,1	2,5	5	20	-	20 10	30	5	60
A 8	green	568	green diffused	2	2,5	5	20	-	20 10	25	5	60
A 9	high efficiency red	625	red diffused	2	2,5	0,7	3	-	2 20	30	5	60
A 10	yellow	588	yellow diffused	2,1	2,5	0,7	1,5	-	2 20	30	5	60
A 11	green	568	green diffused	2,2	2,5	0,7	2	-	2 20	25	5	60
A 12	high efficiency red	625	red diffused	2	2,5	0,7	5	-	2 20	30	5	60
A 13	yellow	588	yellow diffused	1,85	2,5	0,7	2	-	2	30	5	60
A 14	green	568	green diffused	2,2	2,5	0,7	2	-	2 20	25	5	60
A 19	super-red	628	red clear	2	2,5	11,2	-	71	10	40	12	40
A 20	yellow	587	yellow clear	2	2,5	11,2	-	71	10	40	12	40
A 21	green	570	green clear	2	2,5	18	-	112	10	40	12	40
A 22	bright red	660	red diffused	2,25	2,5	0,7	1,6	-	20 10	25	5	70
A 23	yellow	588	yellow diffused	2,1	2,5	5	8	-	20 10	30	5	70
A 24	green	568	green diffused	2,2	2,5	5	10	-	20 10	25	5	70
A 25	red	660	red diffused	2,25	2,5	0,7	2	-	20 10	25	5	60
A 27	yellow	588	yellow diffused	2,1	2,5	3	10	-	20 10	30	5	60
A 28	green	568	green diffused	2,2	2,5	5	15	-	20 10	25	5	60
A 29	high efficiency red	625	red diffused	2	2,5	36	100	-	20	30	5	30
A 30	yellow	588	yellow diffused	2,1	2,5	18	50	-	20	30	5	30
A 31	green	568	green diffused	2,2	2,5	18	60	-	20	25	5	30
A 32	high efficiency red	625	red diffused	2	2,5	36	100	-	20	30	5	30
A 33	yellow	588	yellow diffused	2,1	2,5	10	50	-	20	30	5	30
A 34	green	568	green diffused	2,2	2,5	18	60	-	20	25	5	30
A 35	high efficiency red	625	red diffused	2	2,5	36	80	-	20	30	5	50
A 36	yellow	588	yellow diffused	2,1	2,5	10	30	-	20	30	5	50
A 37	green	568	green diffused	2,2	2,5	10	40	-	20	25	5	50
A 38	bright red	660	red diffused	2,25	2,5	0,4	1	-	20 10	25	5	100
A 40	yellow	588	yellow diffused	2,1	2,5	1	4	-	20 10	30	5	100
A 41	green	568	green diffused	2,2	2,5	1	4	-	20 10	25	5	100
A 42	bright red	660	red diffused	2,25	2,5	0,4	1	-	20 10	25	5	100
A 44	yellow	588	yellow diffused	2,1	2,5	0,7	3	-	20 10	30	5	100
A 45	green	568	green diffused	2,2	2,5	1	4	-	20 10	25	5	100
A 46	high efficiency red	625	red diffused	2	2,5	3	5	-	20 10	30	5	110
A 47	yellow	588	yellow diffused	2,1	2,5	1	4	-	20 10	30	5	110
A 48	green	568	green diffused	2,2	2,5	1,8	5	-	20 10	25	5	110
A 49	high efficiency red/ green	625/568	white diffused	2/2,2	2,5	7	20/16	-	20	30/25	-	60
A 51	blue	430	blue transparent	3,8	4,5	18	100	-	20	30	5	50
A 52	blue	466	blue transparent	3,8	4,5	70	200	-	20	30	5	30

Technische Daten THT LED's

Technical Data THT LEDs

LED-Type	Emission Color	Wavelength λ (nm) dominant	Lense Color	Forward Voltage V_F (V)		Luminous Intensity I_V (mcd)			at mA	Fwd. Current I_F max (mA)	Rev. Voltage V_R (V)	2ϕ (50% I_V) deg.
				typ	max	min	typ	max				
THT												
A 60	high efficiency red	625	red diffused	5,7	7,5	18	61,6	-	20	60	15	120
A 61	yellow	588	yellow diffused	6	7,5	70	372	-	20	60	15	120
A 62	green	568	green diffused	6	7,5	18	53,3	-	20	50	15	120
A 69	super-red	628	red diffused	2	2,5	7,1	-	18	10	40	12	50
A 70	yellow	587	yellow diffused	2	2,5	7,1	-	18	10	40	12	50
A 71	green	570	green diffused	2	2,5	7,1	-	18	10	40	12	50
A 72	super-red	628	red diffused	2	2,5	7,1	-	18	10	40	12	70
A 76	high efficiency red/ green	625/568	white diffused	2/2,2	2,5	4/2,6	10/8	-	20	30/25	-	70
A 77	super bright red	640	red diffused	1,85	2,5	280	400	-	10	30	5	60
A 78	yellow	588	yellow transpa- rent	2,1	2,5	18	40	-	20	30	5	30
A 79	green	568	green transpa- rent	2,2	2,5	18	60	-	20	25	5	30
C 5	orange red/green	619/564	white diffused	2/2,4	3	1	2,5	-	20	30	6	60
C 12	red	630	red diffused	2	3	4	-	32	20	20	6	40
C 13	yellow	588	yellow diffused	2,4	3	2,5	8	12,5	20	30	6	40
C 14	green	568	green diffused	2,4	3	4	12	20	20	30	6	40
E 3	high efficiency red/ green	625/568	white diffused	2/2,2	2,5	10	50/30	-	20	30/25	5	60
G 1	bright red	660	red diffused	2,25	2,5	0,4	0,8	-	20	25	5	40
G 2	yellow	588	yellow diffused	2,1	2,5	2,6	10	-	20	30	5	40
G 3	super bright green	568	green diffused	2,2	2,5	2,6	10	-	20	25	5	40
K 1	super-red	635 (peak)	red diffused	2	2,8	-	12	-	20	30	5	-
K 2	yellow	585 (peak)	yellow diffused	2	2,8	-	12	-	20	30	5	-
K 3	green	565 (peak)	green diffused	2,1	2,8	-	15	-	20	30	5	-
M 2	white	-	colorless clear	3,6	4	2400	-	6800	20	30	5	20
W 1	white	-	colorless clear	3,1	3,7	180	-	450	10	20	5	40
Argus												
A 15	super-red	628	red clear	2,1	2,5	45	-	71	15	40	5	-