

## Features

- Self adhesive circuit board support on base (Pack of 50)
- The support can be permanently fixed to most smooth and clean surfaces, due to the good retention properties of the adhesive
- As the supports require no fixing screws they are particularly useful where a tapped support pillar cannot be used, e.g. on the rear of front panels



## Specification

Material	PA66, UL94-V2
Colour	Natural
Length	32.4 mm
Adhesive Size	17 x 17 x 0.8 mm
Hole Diameter	4 mm +/- 0.05
Panel Thickness	1.6 mm

## Drawing

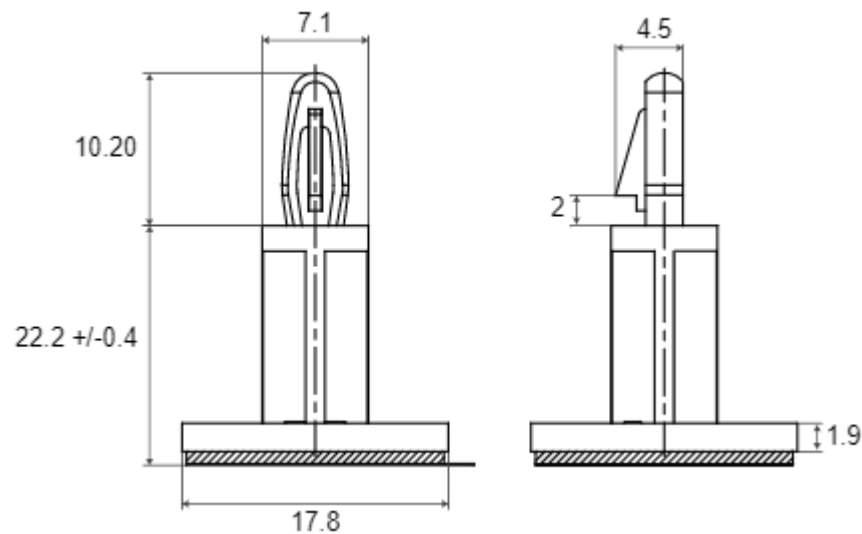

Art. Nr.  
RND 610-00144