

# Cutting pliers

without bevel, ESD

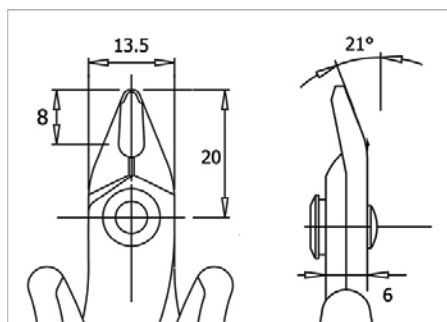

## SPECIFICATION:

Length	138 mm
Head Shape	raised/21°
Variants	ESD
Wire, Cu, ø	1.3 mm
Material	Steel
Cutting type	without bevel

Art. Nr.

RND 550-00111