

"Schutzvermerk nach DIN ISO 16016 beachten" "Please pay attention to copyright note DIN ISO 16016"

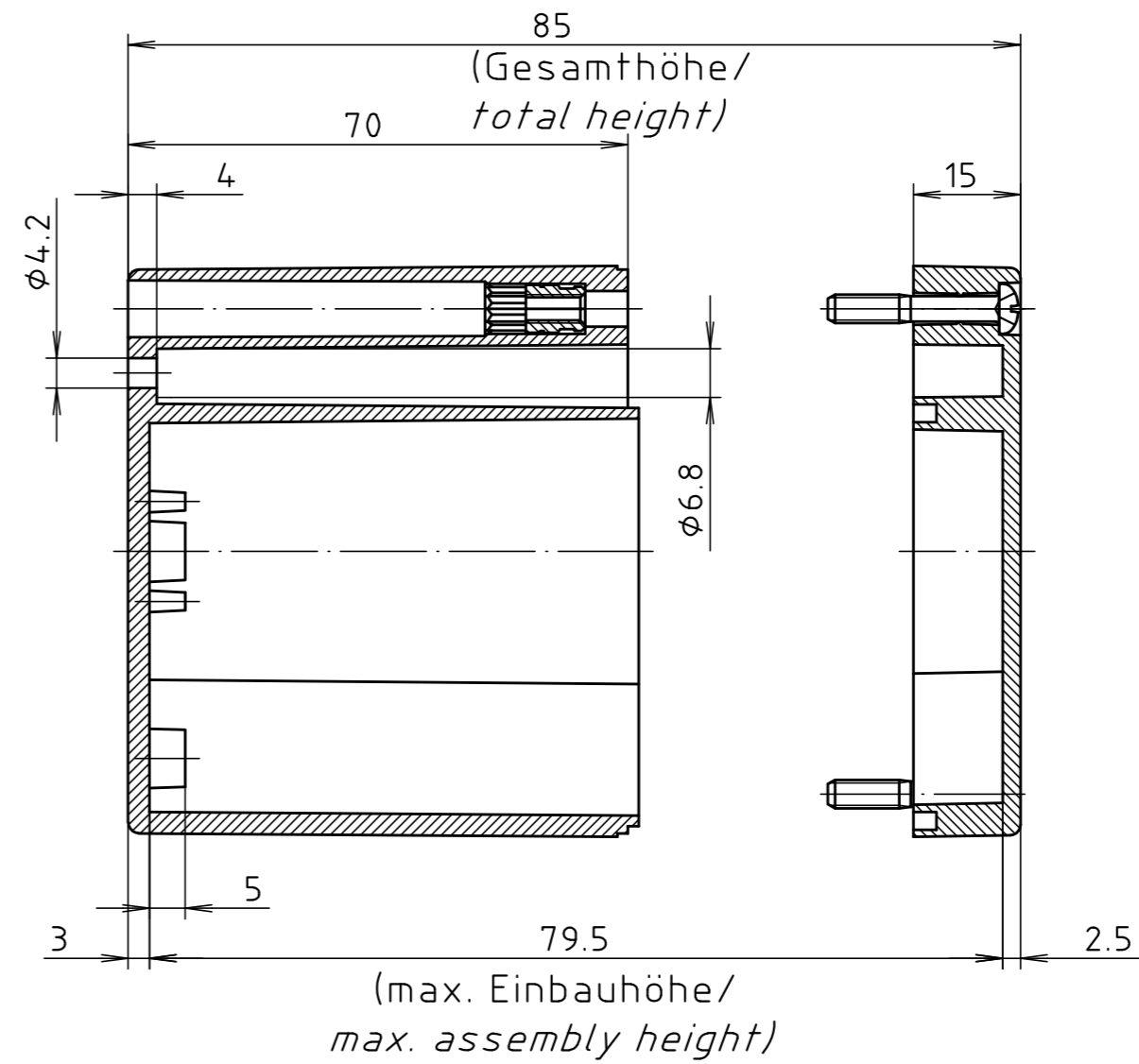
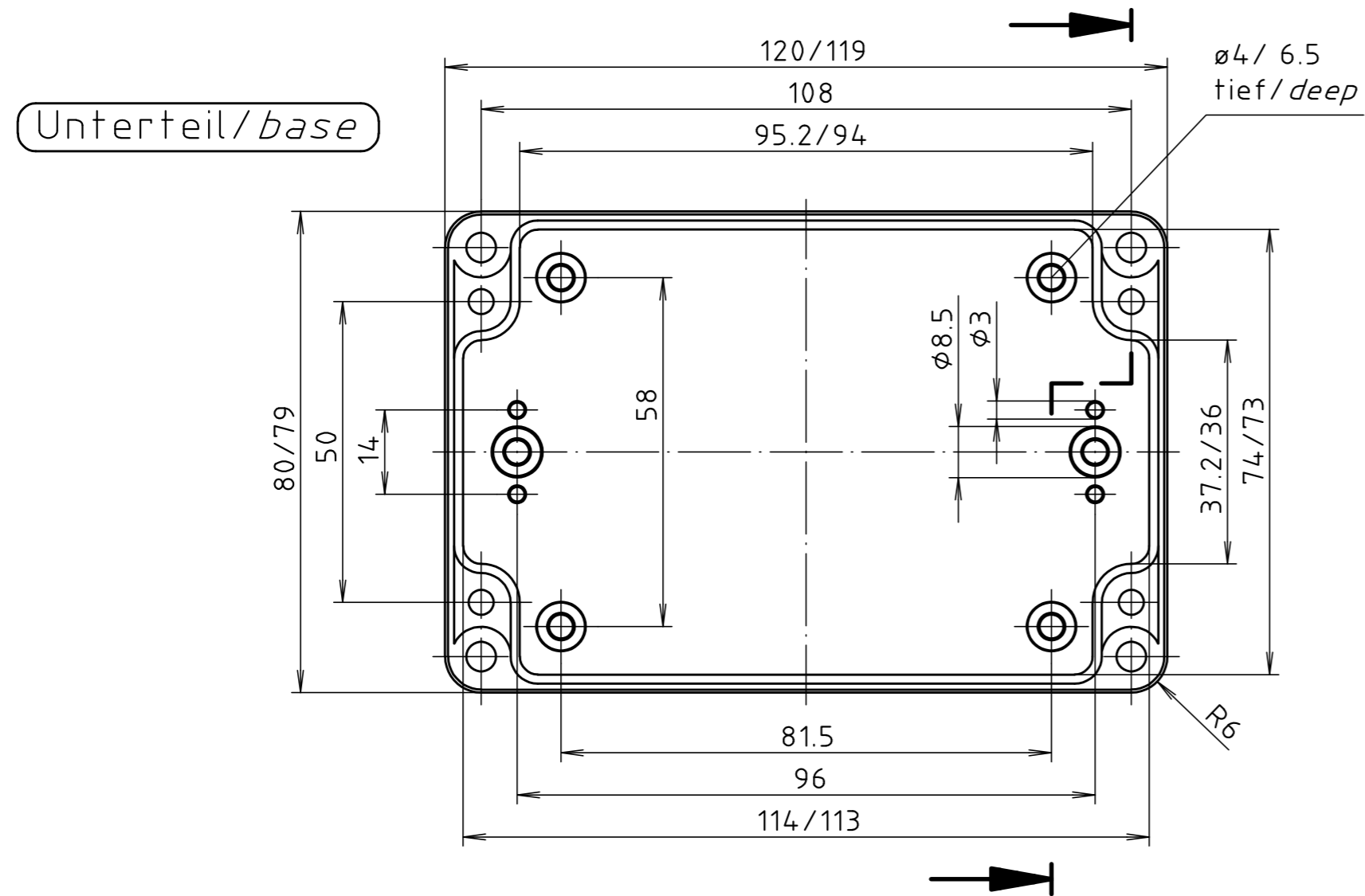
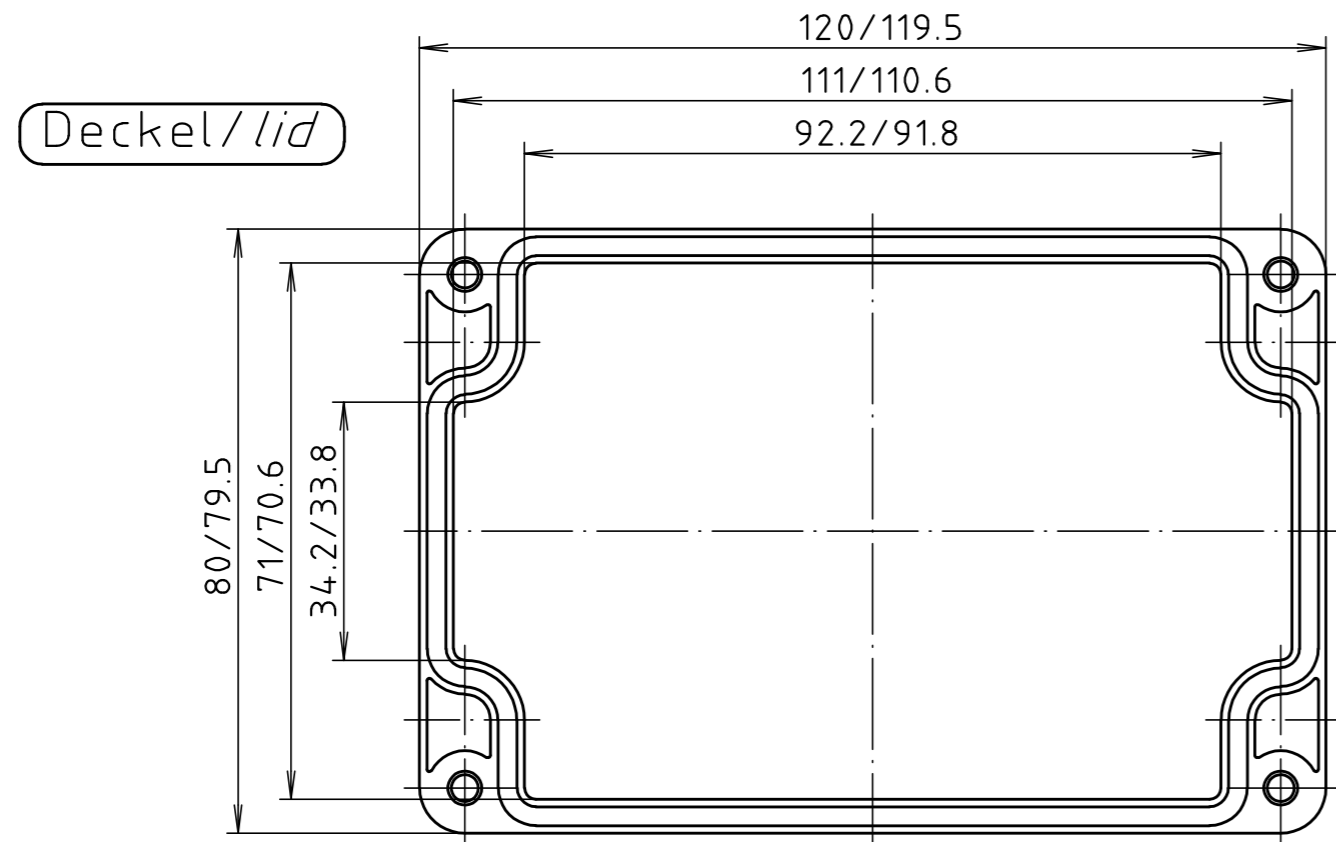

		Allgemein-toleranzen DIN .		Maßstab 1:1	Gewicht .
		Werkstoff PC		Rohteil-Nr. .	
Datum		Name		Benennung	
Bearb. 28.01.20		ES		PC 5U Gehäuse	
Gepr. .		.		Enclosure	
Norm .		.		Zchnng.-Nr.	
.		.		RND 455-01270	
Zust.		Anderung		Ers.für: .	
Datum		Name		Ers.durch: .	
Urspr.: .		.		Blatt	
.		.		Bl.	