

"Schutzvermerk nach DIN ISO 16016 beachten" "Please pay attention to copyright note DIN ISO 16016"

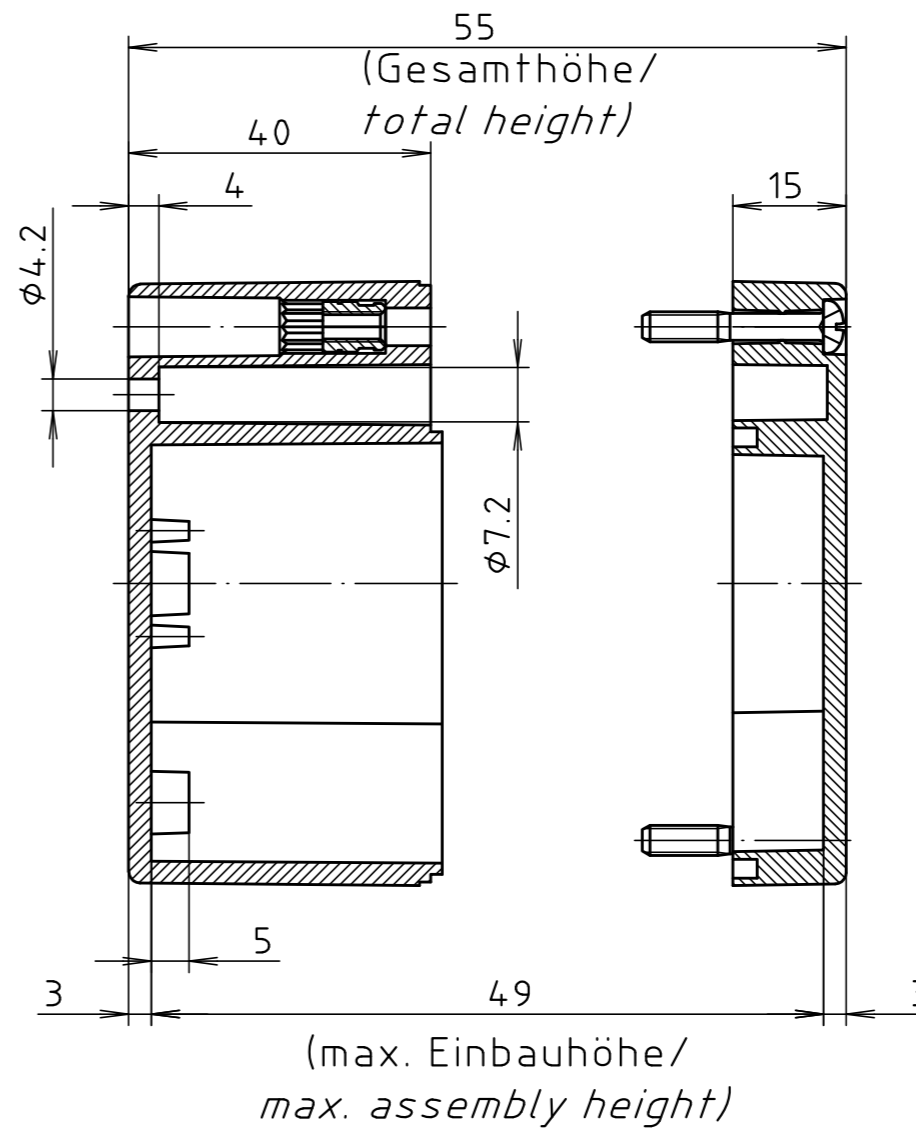
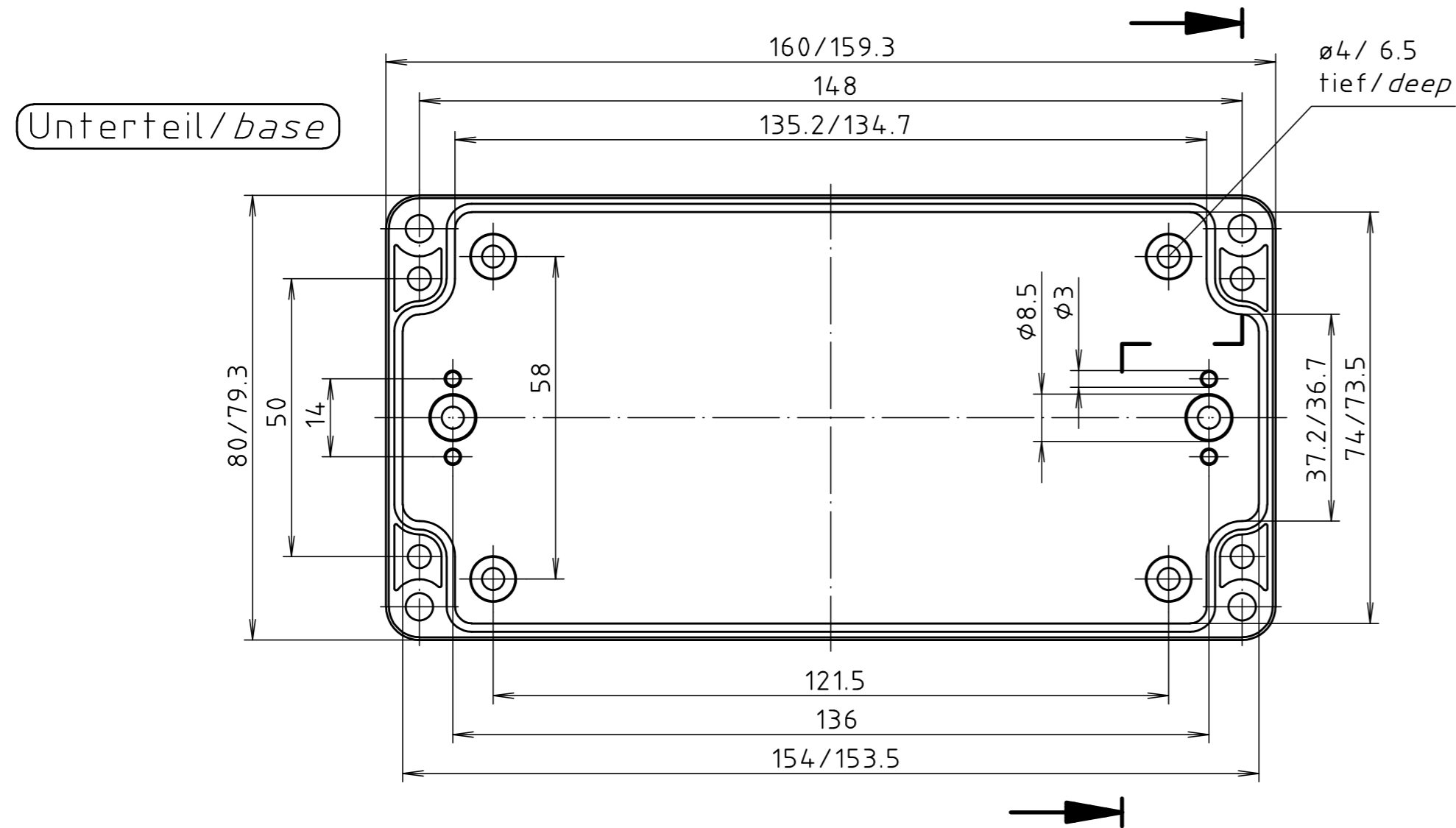
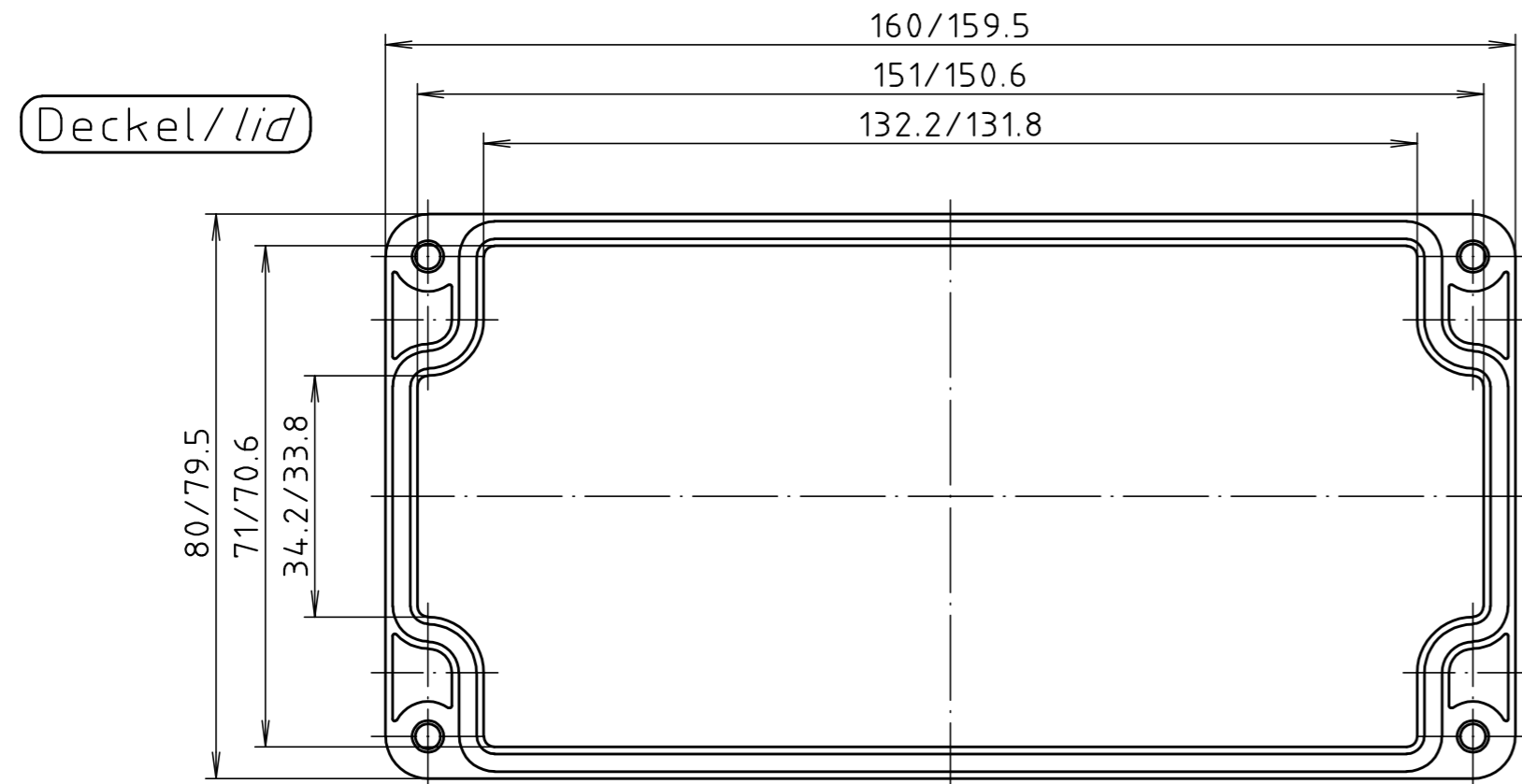

		Allgemein-toleranzen DIN .		Maßstab 1:1		Gewicht .	
		Werkstoff PC		Rohteil-Nr. .		Benennung	
Datum		Name		PC 5U Gehäuse Enclosure			
Bearb. 22.01.20		ES					
Gepr. .		. .					
Norm .		. .		Zchnng.-Nr.		Blatt	
.		RND 455-01262		Bl.	
Zust.	Anderung	Datum	Name	Urspr.	Ers.für:	Ers.durch:	