

SPECIFICATIONS:

ELECTRICAL LIFE: 50,000 make-and-break cycles at full load.

CONTACT RESISTANCE: 10mΩ max. initial @2-4VDC 100mA for both silver and gold plated contacts.

INSULATION RESISTANCE: 1,000MΩ min.

DIELECTRIC STRENGTH: 1,500 VAC @ sea level.

OPERATING TEMPERATURE: -30°C to +85°C

MATERIALS:

CASE: Diallyl phthalate(DAP)(UL 94V-0).

TOGGLE HANDLE: Brass, black finish with o-ring sealed.

BUSHING: Brass, black finish with o-ring sealed

EXTERNAL SHELL: FR52 (UL 94V-0).

TERMINAL SEAL: Epoxy.

Art. Nr.

RND 210-00479

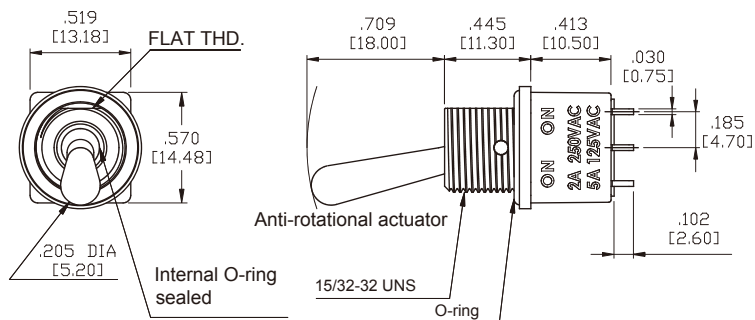

BUSHING

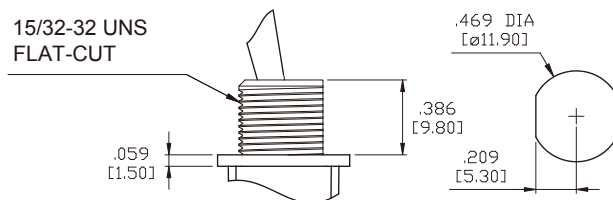

TERMINATION

STD. SOLDER LUG

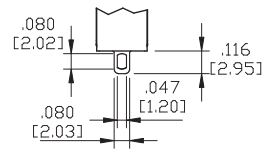

THK .030 [0.75]

ACTUATOR

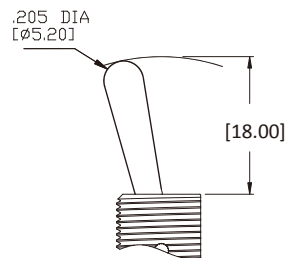

HARDWARE

NUT

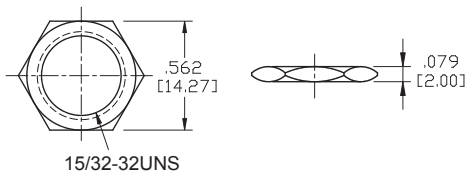

LOCK WASHER

