

## SPECIFICATIONS:

**CONTACT RATING:** 300 mA @ 125 VAC.  
**CURRENT CARRYING CAPACITY:** 5 A continuous. (Non-switching)  
**ELECTRICAL LIFE:** 15000 cycles at full load up to 30,000 detent operations.  
**CONTACT RESISTANCE:** 20 mΩ max. initial.  
**DIELECTRIC STRENGTH:** 500 V RMS @ sea level.  
**OPERATING TEMPERATURE:** -20°C to + 85°C.  
**STOPS:** 2P-6Pos  
**ROTATION TORQUE:** 0.5 ± 0.2 kg/cm.

## MATERIALS:

**SHAFT:** Glass filled nylon, colour-grey.  
**COVER:** Glass filled nylon, colour-grey.  
**BASE:** Glass filled nylon, colour-grey.  
**CONTACTS:** Brass, silver-plated.  
**TERMINALS:** Brass, silver-plated.  
**HARDWARE:** Nut-zinc, nickel-plated.  
**LOCKWASHER:** Steel, bright zinc-plated.  
**STOP RING:** Brass, nickel-plated.

**Art. Nr.**  
**RND 210-00067**

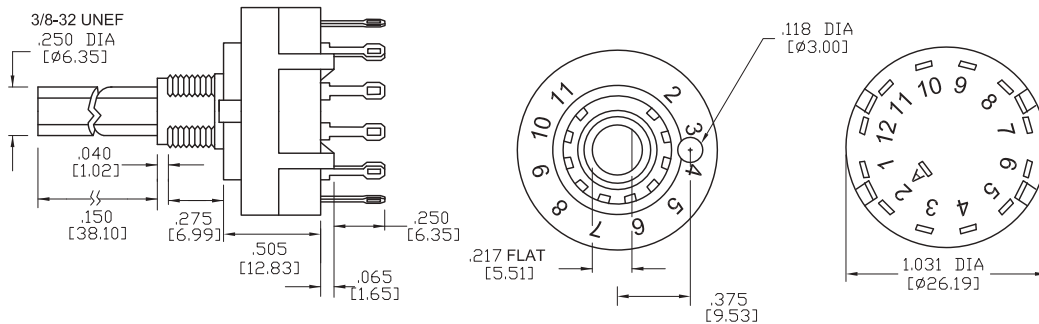

## SWITCHING POSITION

Model No.	Switching Position
RND 210-00067	2P-6Pos

Schematic

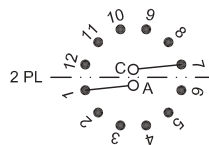

TERM. NOS.  
MOLDED ON HOUSING

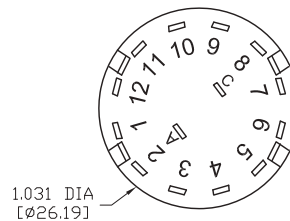

## PANEL MOUNTING

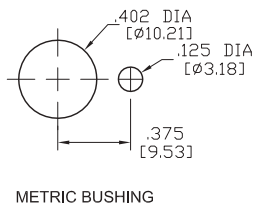
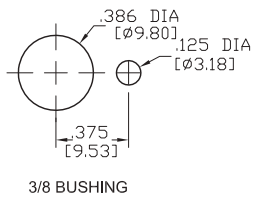

## P.C. MOUNTING

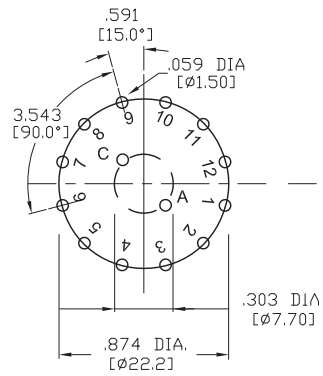

## ACTUATOR OPTIONS

DIM"A"	DIM"L"
.709 [18.00]	.394 [10.00]

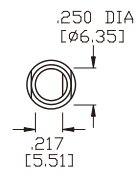
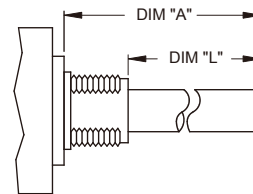

## BUSHING OPTIONS

STD.

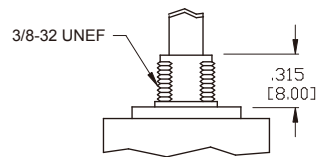

## TERMINATION OPTIONS

STD.

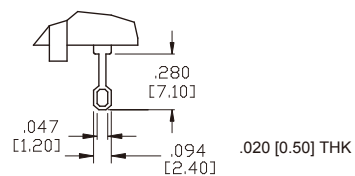

NUT	Q #M# ° o=-k	au\h'k@/8
<p>3/8-32 UNEF-28</p> <p>.500 [12.70]</p> <p>.060 [1.57]</p>	<p>.600 DIA [Ø15.24]</p> <p>.046 [1.17] THK</p>	<p>.540 DIA [Ø13.72]</p> <p>.092 [2.34]</p>

CONTACT OPTIONS

Non-Shorting Contacts: Break before make