

SPECIFICATIONS:

CONTACT RATING: 300 mA @ 125 VAC.
CURRENT CARRYING CAPACITY: 5 A continuous. (Non-switching)
ELECTRICAL LIFE: 15000 cycles at full load up to 30,000 detent operations.
CONTACT RESISTANCE: 20 mΩ max. initial.
DIELECTRIC STRENGTH: 500 V RMS @ sea level.
OPERATING TEMPERATURE: -20°C to + 85°C.
STOPS: 1P-12Pos
ROTATION TORQUE: 0.5 ± 0.2 kg/cm.

MATERIALS:

SHAFT: Glass filled nylon, colour-grey.
COVER: Glass filled nylon, colour-grey.
BASE: Glass filled nylon, colour-grey.
CONTACTS: Brass, silver-plated.
TERMINALS: Brass, silver-plated.
HARDWARE: Nut-zinc, nickel-plated.
LOCKWASHER: Steel, bright zinc-plated.
STOP RING: Brass, nickel-plated.

Art. Nr.
RND 210-00065

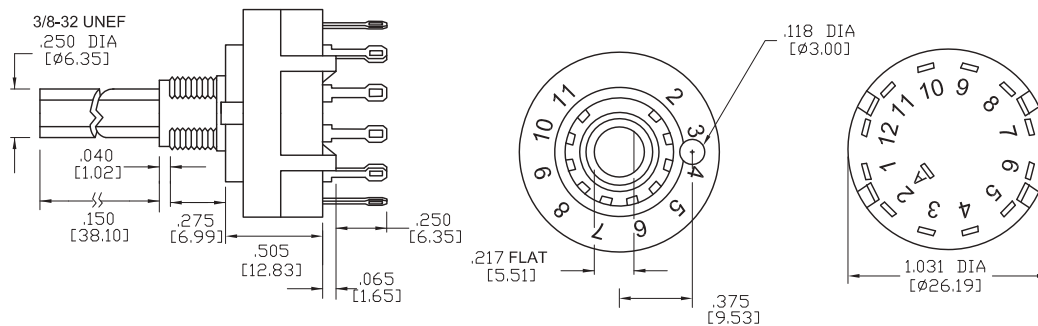

SWITCHING POSITION

Model No.	Switching Position
RND 210-00065	1P-12Pos

Schematic

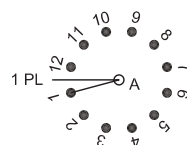

TERM. NOS.
MOLDED ON HOUSING

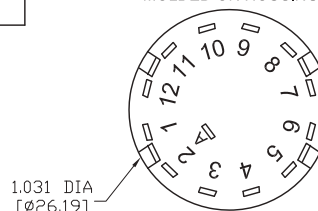

PANEL MOUNTING

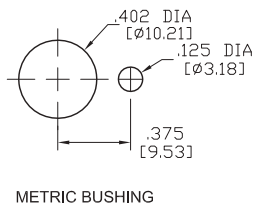
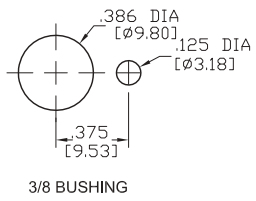

P.C. MOUNTING

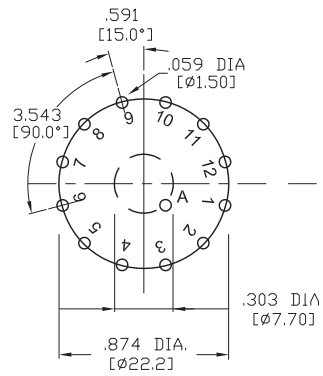

ACTUATOR OPTIONS

DIM"A"	DIM"L"
1.496 [38.00]	1.181 [30.00]

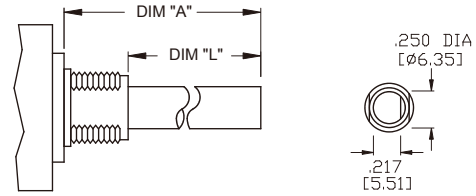

BUSHING OPTIONS

STD.

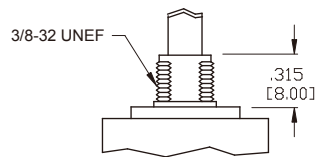

TERMINATION OPTIONS

STD.

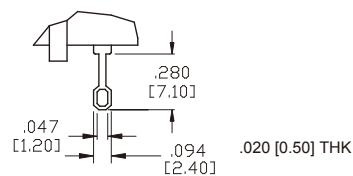

NUT	Q #M# ° o=-k	au\h'k@/8
<p>3/8-32 UNEF-28</p> <p>.500 [12.70]</p> <p>.060 [1.57]</p>	<p>.600 DIA [Ø15.24]</p> <p>.046 [1.17] THK</p>	<p>.540 DIA [Ø13.72]</p> <p>.092 [2.34]</p>

CONTACT OPTIONS

Non-Shorting Contacts: Break before make