

Specification:

Rated current	50A
Rated voltage	600V
Insulation Resistance	5000MΩ
Contact Resistance	0.055±0.005mΩ
Voltage Proof	2200VDC
Life: Without Load(Contact/Disconnect Cycles)	To 10000
Life: With Load(Hot Plug 250 Cycles & 120V)	40A
Flammability	UL94 V-0
Average Connection/Disconnection	95±5N
Contact Barrel Wire Size	6AWG~10-12AWG
Connector Holding Force	250N Min
Environment Temperatures	-20°C...125°C

Material and Surface Performance:**Housing**

Housing Material	PC
Process of Production	Plastic Injection

Shrapnel

Shrapnel Material	Stainless Steel
Process of Production	Precision Punching

Terminal

Terminal Material	Red Copper
Process of Production	Precision Punching
Plating	Ag

Housing

Part Number	Housing Colour
RND 205SG50H-BL	Black
RND 205SG50H-GY	Grey
RND 205SG50H-RE	Red
RND 20550-0001	Red
RND 20550-0002	Grey

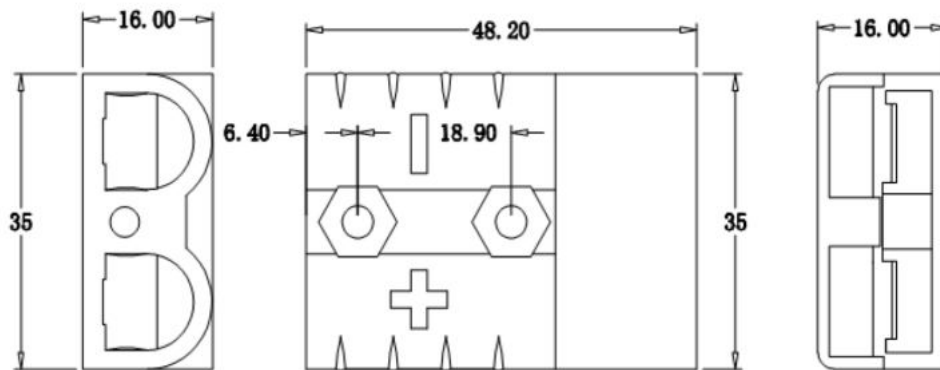

Terminal

Part Number	-A-(mm)	-B-(mm)	-C-(mm)	-D-(mm)	Wire size	Current
RND 205SGD5900-T	29.6	6.9	5.6	12.2	6AWG	50A
RND 205SGD5952-T	29.6	6.9	4.7	12.2	8AWG	50A
RND 205SGD5915-T	29.6	6.9	3.5	12.2	10-12AWG	50A

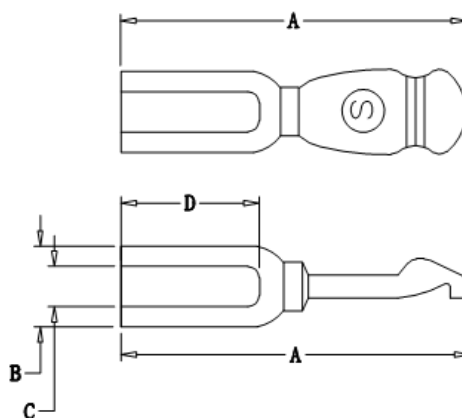

Handle

Part Number	-A-(mm)	-B-(mm)	-C-(mm)	-D-(mm)	-E-(mm)	-F-(mm)
RND 205SG112G1-RE	5.5	14.5	49	9.6	5.8	4.0
RND 205SG112G1-GY	9.6	49	3.5	19.0	14.5	55.5

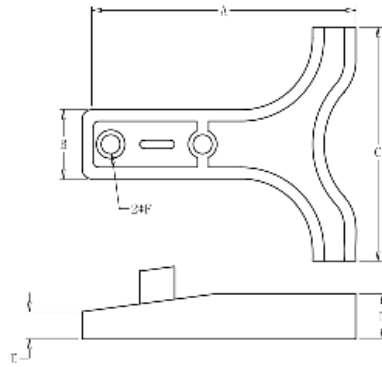

Dust Cover

Part Number	Colour
RND 205SG111F1-BL	Black
RND 205SG111F1-RE	Red

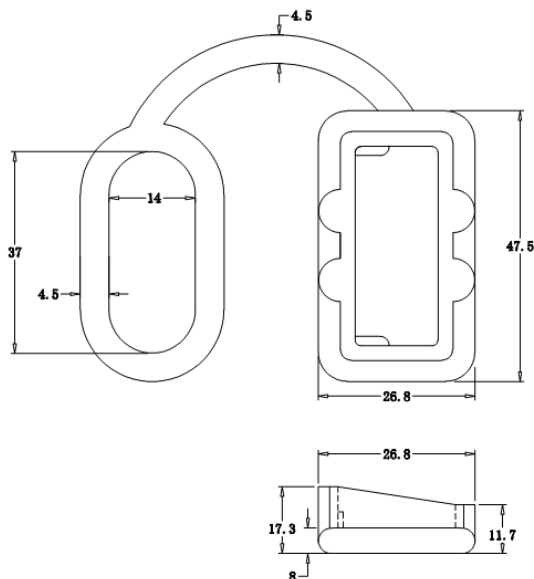

Dust Cover

Part Number	Colour
RND 205SG111F2-BL	Black

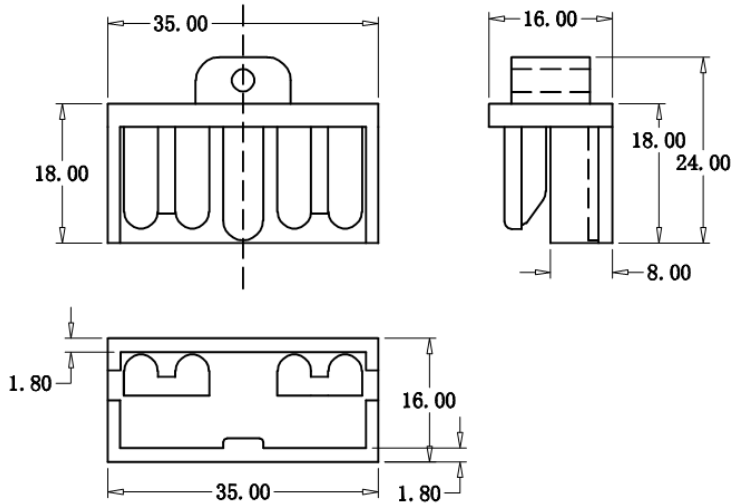

Solid Line Plug

Part Number	Colour
RND 205SG111F3-RE	Red

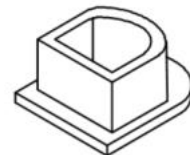
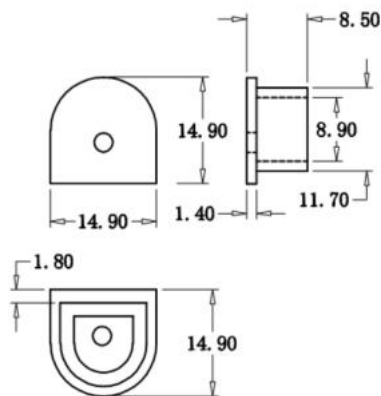

Waterproof Plug

Part Number	Colour
RND 205HU50A-RE	Red

