

# Wafer

## 1 x 4P Male



### FEATURES:

### SPECIFICATION:

Poles	1 x 4
Connector Design	Single row/straight
Pitch	2.54 mm
Gender of contacts	Male
Connector Termination	straight
Rated voltage	250 VAC
Colour	beige
Housing Material	Nylon 66
Temperature range	-25...+85 °C

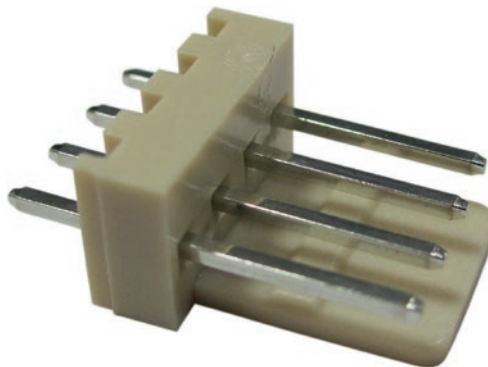

### DRAWING:

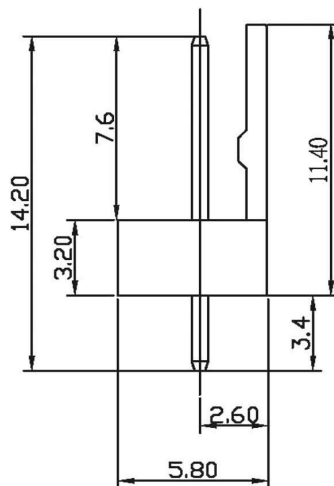
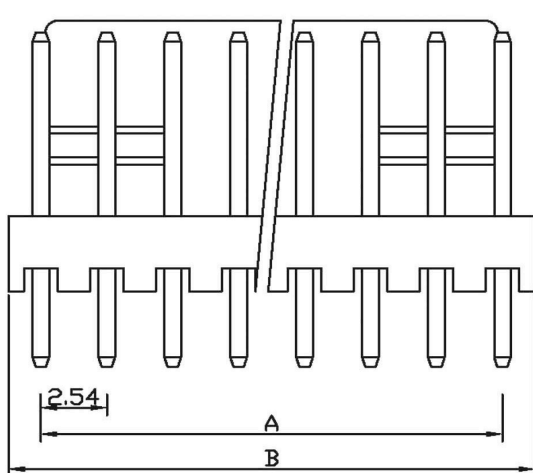
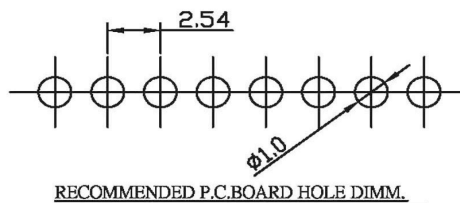
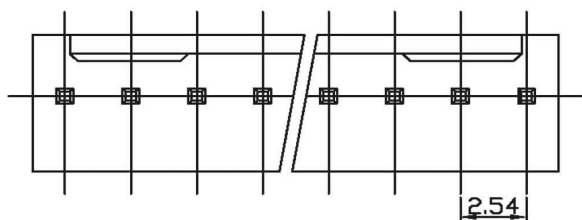

Poles	Dimension mm (in.)	
	A	B
2	2.54(0.100)	5.12(0.202)
3	5.08(0.200)	7.66(0.302)
4	7.62(0.300)	10.20(0.402)
5	10.16(0.400)	12.74(0.502)
6	12.70(0.500)	15.30(0.602)
7	15.24(0.600)	17.94(0.706)
8	17.78(0.700)	20.48(0.806)
9	20.32(0.800)	23.02(0.906)
10	22.86(0.900)	25.58(1.007)
11	25.40(1.000)	28.12(1.107)
12	27.94(1.100)	30.68(1.208)
13	30.48(1.200)	33.10(1.303)
14	33.02(1.300)	35.80(1.409)
15	35.56(1.400)	38.34(1.509)
16	38.10(1.500)	40.94(1.612)
17	40.64(1.600)	43.30(1.705)
18	43.18(1.700)	45.90(1.807)
20	48.26(1.900)	50.80(2.000)

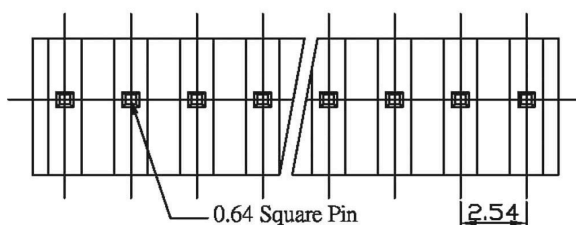

Art. Nr.  
RND 205-00673