

Features

- Superior quality pin header
- For professional and industrial use
- Great use in board to board, wire-wrap or programming applications

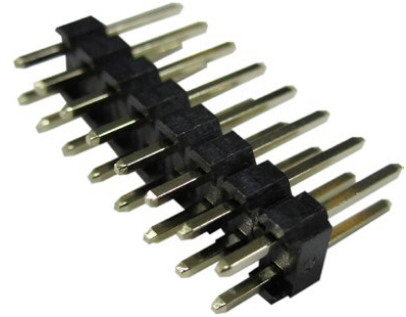

Specification

Number of Poles	16
Number of Lines	2
Current	3 A
Operating Temperature	-55 ... 105 °C
Connector Design	Straight
Pitch	2.54 mm
Contact Gender	Plug
Connector Termination	THT
Colour	Black
Contact Resistance	20 mOhm min.
Insulation Resistance	100 MOhm min.
Withstanding Voltage	1 kVAC RMS

Material Specification

Housing	Thermoplastic, UL94V-0
Contact	Copper Alloy

Drawing

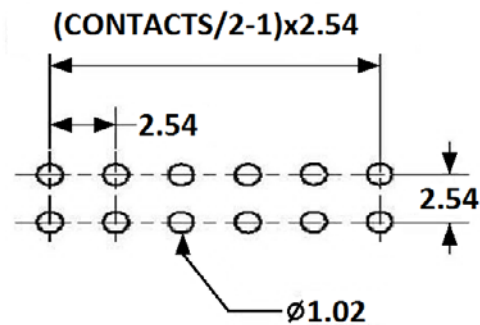
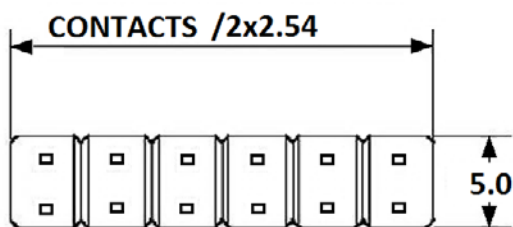

RECOMMENDED P.C.B LAYOUT

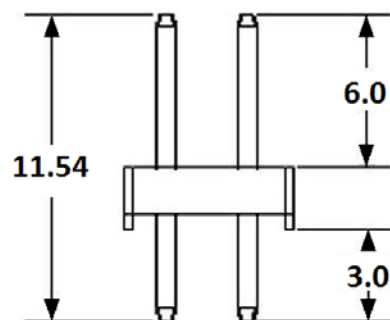
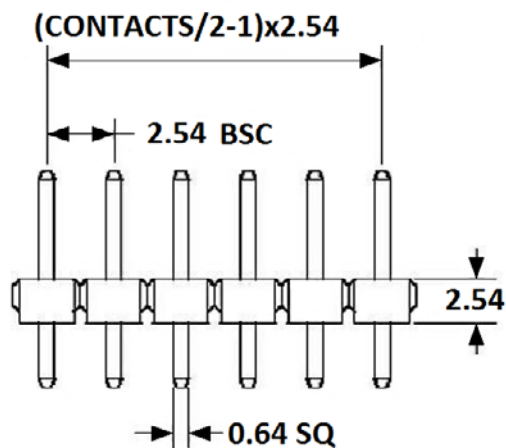

Accessories



Short-Circuit Jumper

RND 205-00797

RND 205-00798

RND 205-00799

Art. Nr.

RND 205-00639