

Features

- RND filters are designed for easy and fast chassis mounting
- High conducted attenuation performance
- Terminals for easy assembly

Applications

- Electrical and electronic equipment / power systems
- Datacom equipment / stepper motor drives
- Stepper motor drives / UPS and inverters

Specification

Voltage Rating	115 / 250 VAC
Current Rating - A @ 115 VAC	2 A RMS Max.
Current Rating - B @ 250 VAC	2 A RMS Max.
Operating Frequency	50 / 60 Hz
Leakage Current: Each Line to Ground - A @ 115 VAC / 60 Hz	0.4 mA max.
Leakage Current: Each Line to Ground - B @ 250 VAC / 50 Hz	0.8 mA max.
Hipot Rating - A - Line to Ground	2250 VDC
Hipot Rating - B - Line to Line	500 VDC
Operating Temperature Min.	-25 °C
Operating Temperature Max.	100 °C
IR	50 MOhm @ 500 VDC Any Input or Output to Ground

Electrical Schematic

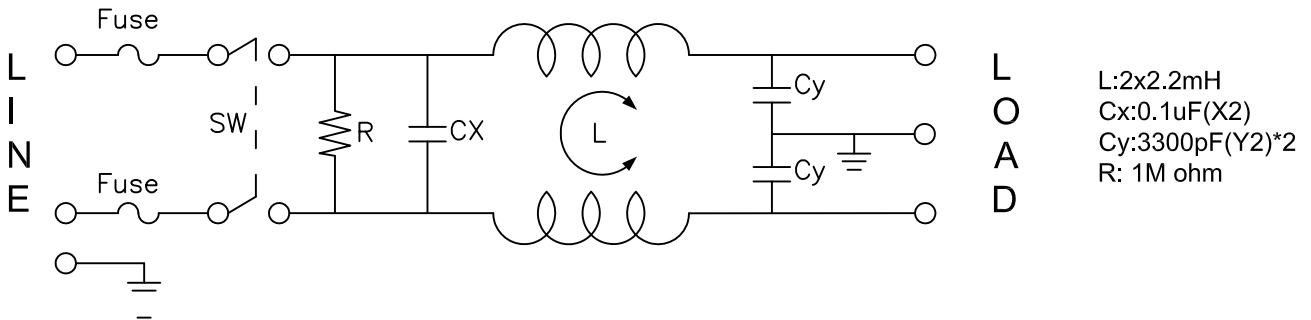

Drawing

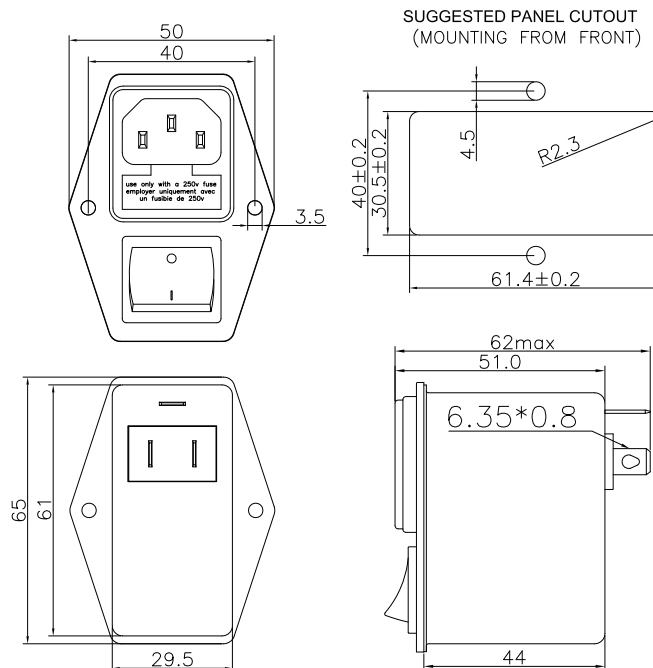

Art Nr.
RND 165-00112