

Features:

- PLCC-6 white package.
- High reliability package with silicone encapsulation.
- Ideal for backlight and light pipe application.
- Suitable for reflow and wave solder processes.

Applications:

- Non-automotive use.
- General signage backlighting.
- Amusement machine backlighting.
- Industrial lighting.
- Light strips.

Part No.	Emitting Color	Lens Color(LED)
RND 135-00190	Cool White	Yellow Diffused

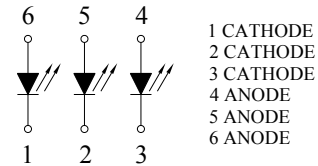
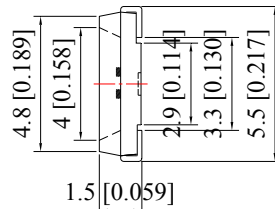
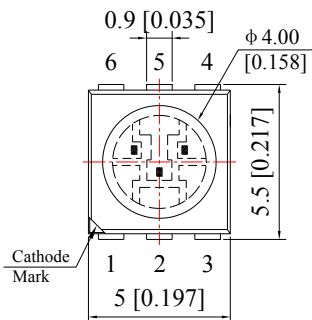

Polarity

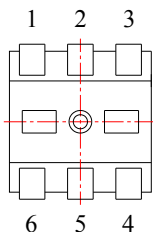
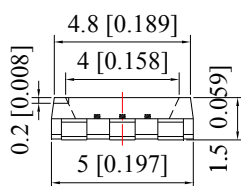

Recommended Soldering Pad dimensions

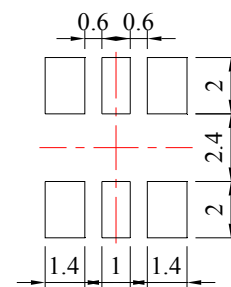

Unit: mm
 Tolerance: $\pm 0.10\text{mm}$

Absolute Maximum Ratings at Ta=25°C

Parameters	Symbol	Max	Unit
Power Dissipation	Pd	90X3	mW
Peak Forward Current ^(a)	IFP	100X3	mA
DC Forward Current ^(b)	IF	25X3	mA
Reverse Voltage	VR	5	V
Electrostatic Discharge (HBM)	ESD	1000	V
Operating Temperature Range	Topr	-40°C to +80°C	
Storage Temperature Range	Tstg	-40°C to +85°C	
Soldering Temperature	Tsld	260°C for 5 Seconds	

Notes:

- a. Derate linearly as shown in derating curve.
- b. Duty Factor = 10%, Frequency = 1 kHz

Electrical Optical Characteristics at Ta=25°C

Parameters	Symbol	Min.	Typ.	Max.	Unit	Test Condition
Luminous Intensity ^(a)	IV	5800	6500	---	mcd	IF=20mA×3=60mA
Luminous Flux ^(a)	Φv	20	22	---	lm	IF=20mA×3=60mA
Viewing Angle ^(b)	2θ1/2	---	120	---	Deg	IF=20mA×3=60mA
Chromaticity Coordinates ^(c)	x	---	0.28	---		IF=20mA×3=60mA
	y	---	0.29	---		
Color Temperature	CCT	8000	10000	---	K	IF=20mA×3=60mA
Color Rendering Index	CRI	70	---	---	Ra	IF=20mA×3=60mA
Forward Voltage	VF	2.80	3.20	3.60	V	IF=20mA×3=60mA
Reverse Current	IR	---	---	10	μA	VR=5V

Notes:

- a. ALuminous intensity is measured with a light sensor and filter combination that approximates the CIE eye-response curve.
- b. 2θ1/2 is the o -axis angle where the luminous intensity is 1/2 the peak intensity
- c. The dominant wavelength (λd) is derived from the CIE chromaticity diagram and represents the single wavelength which defines the color of the device.

Typical Electrical / Optical Characteristics Curves (25°C Ambient Temperature Unless Otherwise Noted)

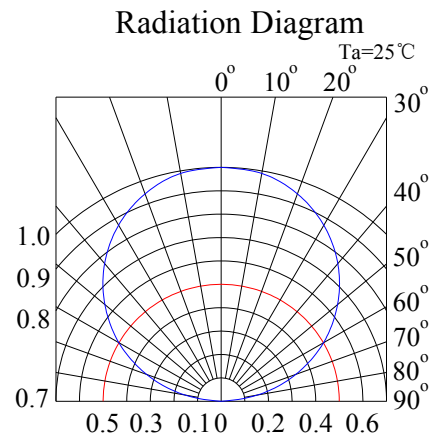
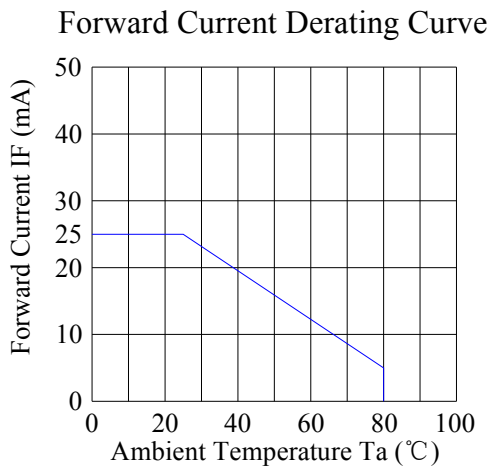
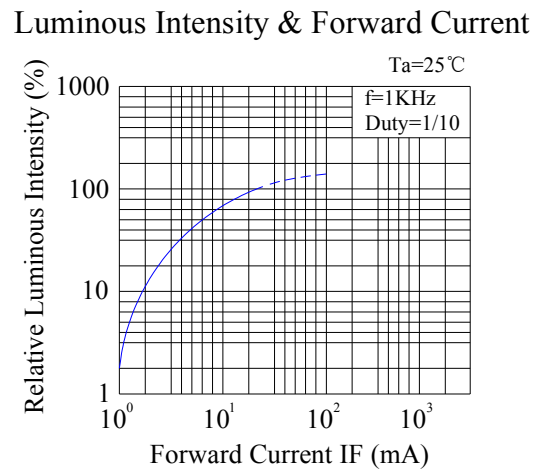
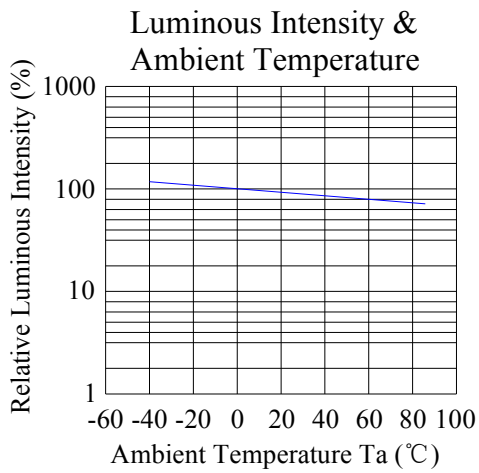
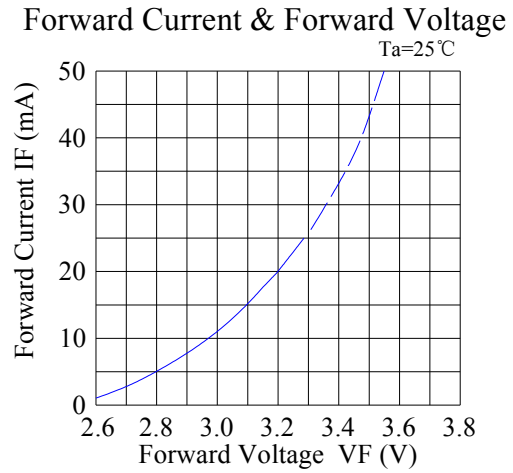
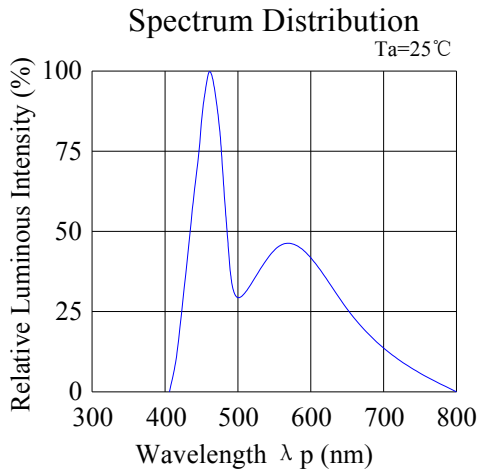

CIE 1931 Chromaticity Diagram:

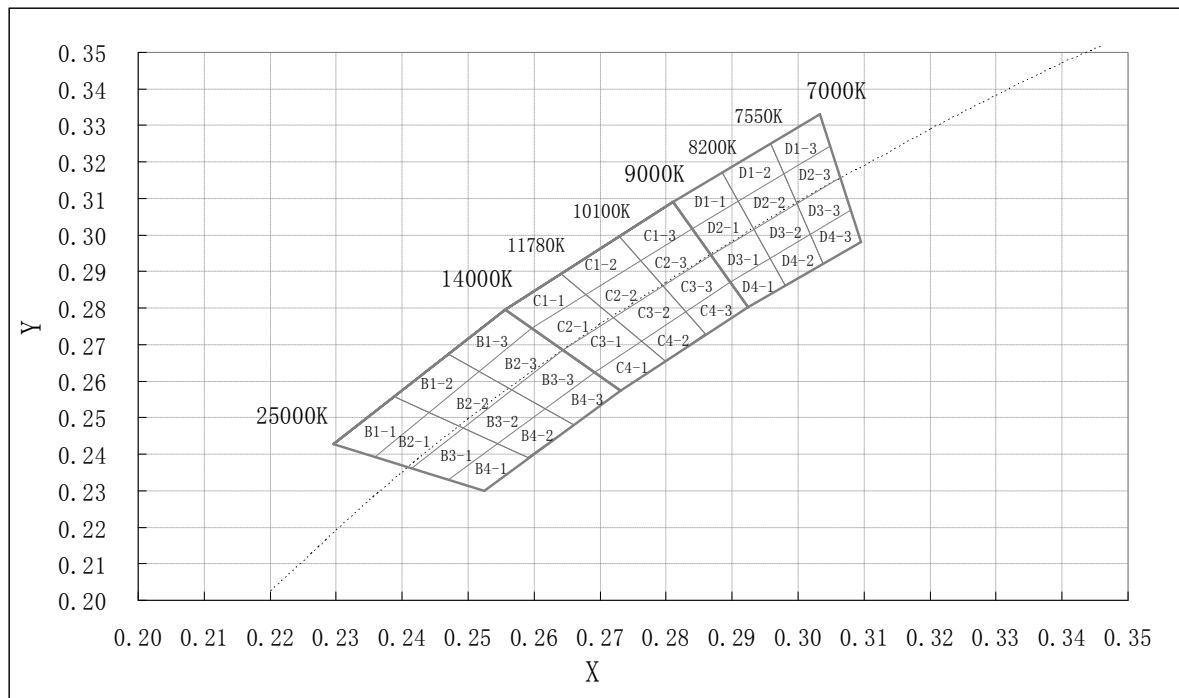

Chromaticity Coordinates Specifications for Bin Rank:

B1-1	0.230	0.243	0.239	0.255	0.244	0.251	0.236	0.239
B2-1	0.236	0.239	0.244	0.251	0.249	0.247	0.241	0.236
B3-1	0.241	0.236	0.249	0.247	0.254	0.243	0.247	0.233
B4-1	0.247	0.233	0.254	0.243	0.259	0.239	0.252	0.230
B1-2	0.239	0.255	0.247	0.267	0.252	0.262	0.244	0.251
B2-2	0.244	0.251	0.252	0.262	0.257	0.258	0.249	0.247
B3-2	0.249	0.247	0.257	0.258	0.261	0.253	0.254	0.243
B4-2	0.254	0.243	0.261	0.253	0.266	0.248	0.259	0.239
B1-3	0.247	0.267	0.256	0.280	0.260	0.274	0.252	0.262
B2-3	0.252	0.262	0.260	0.274	0.264	0.269	0.257	0.258
B3-3	0.257	0.258	0.264	0.269	0.269	0.263	0.261	0.253
B4-3	0.261	0.253	0.269	0.263	0.273	0.257	0.266	0.248
C1-1	0.256	0.280	0.264	0.289	0.268	0.283	0.260	0.274
C2-1	0.260	0.274	0.268	0.283	0.272	0.277	0.264	0.269
C3-1	0.264	0.269	0.272	0.277	0.276	0.271	0.269	0.263
C4-1	0.269	0.263	0.276	0.271	0.280	0.265	0.273	0.257
C1-2	0.264	0.289	0.273	0.299	0.276	0.293	0.268	0.283
C2-2	0.268	0.283	0.276	0.293	0.279	0.286	0.272	0.277
C3-2	0.272	0.277	0.279	0.286	0.283	0.279	0.276	0.271

Chromaticity Coordinates Specifications for Bin Rank:

C4-2	0.276	0.271	0.283	0.279	0.286	0.273	0.280	0.265
C1-3	0.273	0.299	0.281	0.309	0.284	0.302	0.276	0.293
C2-3	0.276	0.293	0.284	0.302	0.287	0.295	0.279	0.286
C3-3	0.279	0.286	0.287	0.295	0.290	0.287	0.283	0.279
C4-3	0.283	0.279	0.290	0.287	0.292	0.280	0.286	0.273
D1-1	0.281	0.309	0.288	0.317	0.291	0.309	0.284	0.302
D2-1	0.284	0.302	0.291	0.309	0.293	0.302	0.287	0.295
D3-1	0.287	0.295	0.293	0.302	0.296	0.294	0.290	0.287
D4-1	0.290	0.287	0.296	0.294	0.298	0.286	0.292	0.280
D1-2	0.288	0.317	0.296	0.325	0.298	0.317	0.291	0.309
D2-2	0.291	0.309	0.298	0.317	0.300	0.308	0.293	0.302
D3-2	0.293	0.302	0.300	0.308	0.302	0.300	0.296	0.294
D4-2	0.296	0.294	0.302	0.300	0.304	0.292	0.298	0.286
D1-3	0.296	0.325	0.303	0.333	0.305	0.324	0.298	0.317
D2-3	0.298	0.317	0.305	0.324	0.307	0.315	0.300	0.308
D3-3	0.300	0.308	0.307	0.315	0.308	0.307	0.302	0.300
D4-3	0.302	0.300	0.308	0.307	0.310	0.298	0.304	0.292

Because different board designs use different number and types of devices, solder pastes, reflow ovens, and circuit boards, no single temperature profile works for all possible combinations.

However, you can successfully mount your packages to the PCB by following the proper guidelines and PCB-specific characterization.

Drive Method

An LED is a current-operated device. In order to ensure intensity uniformity on multiple LEDs connected in parallel in an application, it is recommended that a current limiting resistor be incorporated in the drive circuit, in series with each LED as shown in Circuit A below.

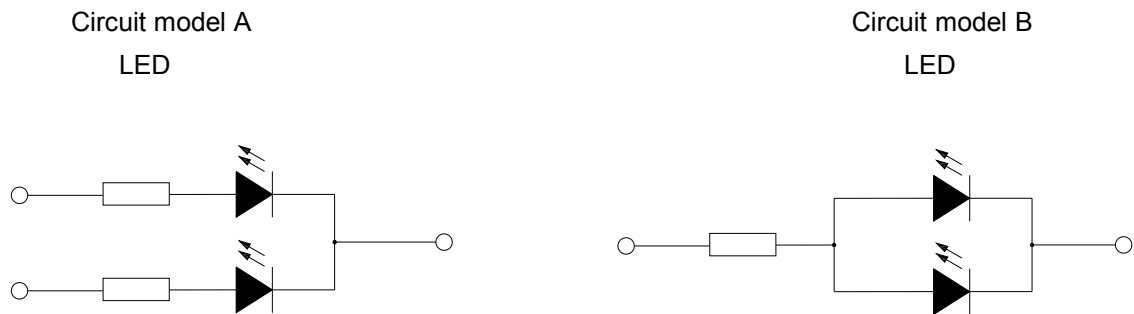

a. Recommended circuit.

b. The brightness of each LED might appear different due to the differences in the I-V characteristics of those LEDs.

ESD (Electrostatic Discharge):

- Use of a conductive wrist band or anti-electrostatic glove when handling these LEDs.
- All devices, equipment, and machinery must be properly grounded.
- Work tables, storage racks, etc. should be properly grounded.
- Use ion blower to neutralize the static charge which might have built up on surface of the LED's plastic lens as a result of friction between LEDs during storage and handling.

ESD-damaged LEDs will exhibit abnormal characteristics such as high reverse leakage current, low forward voltage, or “no lightup” at low currents. To verify for ESD damage, check for “lightup” and V_f of the suspect LEDs at low currents. The V_f of “good” LEDs should be $>2.0V@0.1mA$ for InGaN product and $>1.4V@0.1mA$ for AlInGaP product.