

Product Data Sheet RG190-39/18/2TDMLO

ebmpapst

The engineer's choice



RG190-39/18/2TDMLO

INDEX

1	General	3
2	Mechanics	3
2.1	General.....	3
2.2	Connections.....	3
3	Operating Data	5
3.1	Electrical Interface - Input.....	5
3.2	Electrical Operating Data	7
3.3	Electrical Interface - Output.....	8
3.4	Electrical Features	8
3.5	Aerodynamics.....	10
3.6	Sound Data.....	11
4	Environment	11
4.1	General.....	11
4.2	Climatic Requirements	11
4.3	EMC	11
5	Safety	13
5.1	Electrical Safety	13
5.2	Approval Tests.....	13
6	Reliability	13
6.1	General.....	13

1 General

Fan type	Blower	
Rotating direction looking at rotor	Clockwise	
Airflow direction	Air in axially, Air out radially	
Bearing system	Ball bearing	
Mounting position - shaft	Any	

2 Mechanics

2.1 General

Width	226 mm	
Height	226 mm	
Depth	85,5 mm	
Mass	1,21 kg	
Housing material	Plastic	
Impeller material	Plastic	

2.2 Connections

Electrical connection	Wires	
Lead wire length	L = 350 mm	
Tolerance	+/- 10 mm	
Tube length	S = 35 mm	
Tolerance	+/- 5 mm	

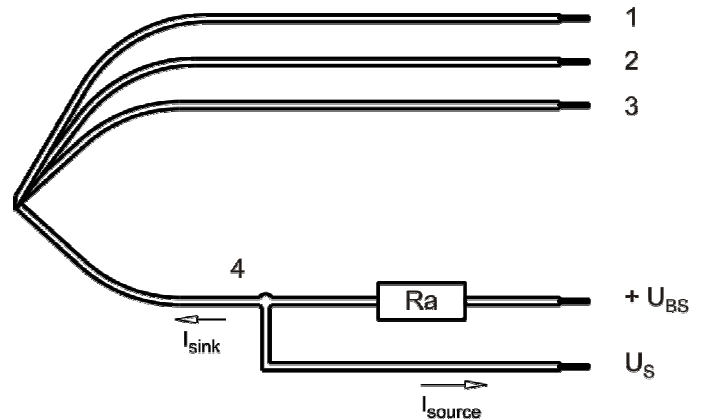

Wire	Color	Operation	Wire size	Insulation diameter
1	red	+ UB	AWG 22	1,7 mm
2	blue	- GND	AWG 22	1,7 mm
3	violet	CONTR	AWG 22	1,7 mm
4	white	Tacho	AWG 22	1,7 mm

The auxiliaries shown on the schematic diagram (which are required for the intended use) are not part of our delivery.

3 Operating Data

3.1 Electrical Interface - Input

Control input	Analog
---------------	--------

Features

PWM - Frequency	1 kHz - 10 kHz typical: 2 kHz
Input voltage range	0 V - 10 V

Characteristics

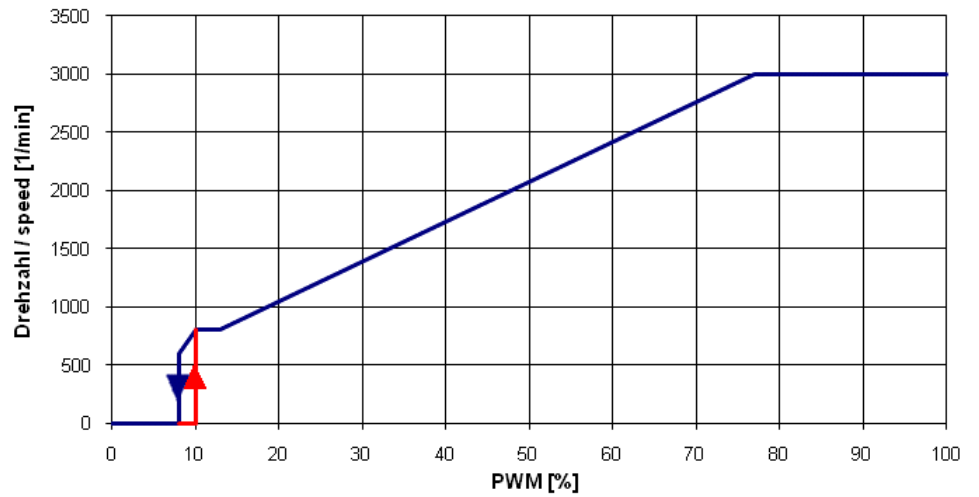
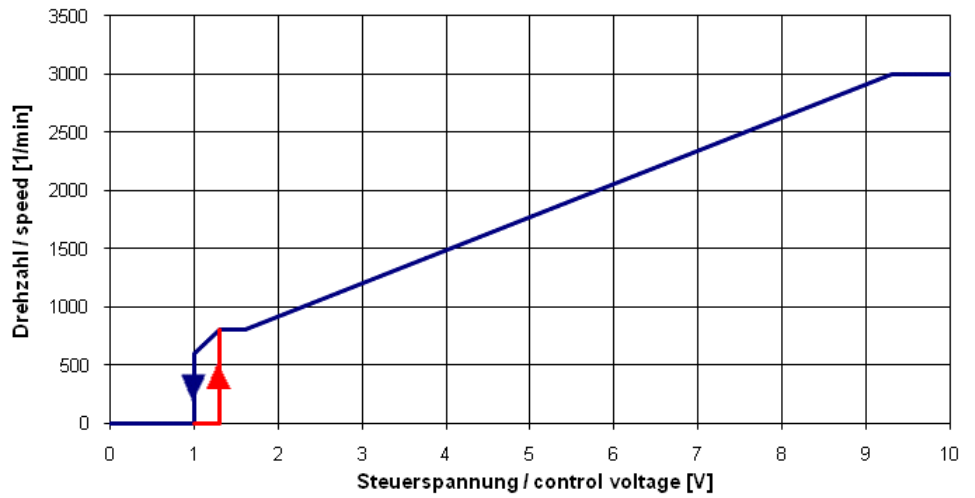

Schematics

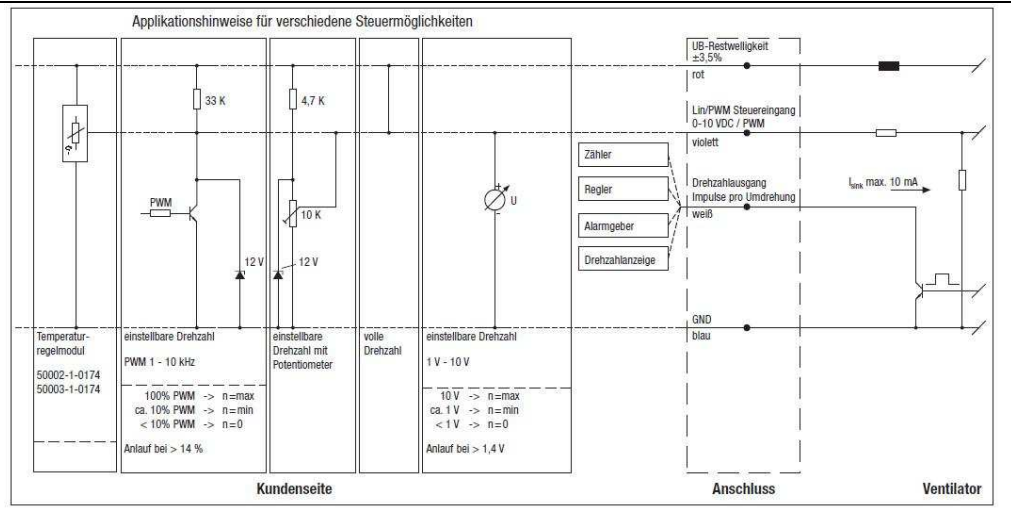

Input voltage divider:

R1 = 47 kOhm

R2 = 36 kOhm

For protection: There is parallel to R2 a 5,1 V Z-Diode

Speed control:

By pulse-width modulation (PWM) 0 ... 100%
 with switching transistor in emitter circuit and collector resistance to 12 V
 Frequency = 2 kHz (1 - 10 kHz)

Information to the curve PWM:

- 0% - <10% PWM: 0 1/min
- 10% PWM: 800 1/min (Fan on, comming from 0% PWM)
- 10% - 13% PWM: 800 1/min (corresponding to min. speed)
- 13% - 78% PWM: linear increasing curve
- 78% - 100% PWM: 3.000 1/min (corresponding to max. speed)
- 10% - >8% PWM: linear decreasing curve (comming from 100% PWM)
- 8% PWM: 600 1/min or 0 1/min (Fan off, comming from 100% PWM)

or:

Speed control:

By analog voltage 0 - 10 V

Information to the curve analog:

- 0 V - < 1,3 V: 0 1/min
- 1,3 V: 800 1/min (Fan on, comming from von 0 V)
- 1,3 V - 1,6 V: 800 1/min (corresponding to min. speed)
- 1,6 V - 9,4 V: linear increasing curve
- 9,4 V - 10 V: 3.000 1/min (corresponding to max. speed)
- 1,3 V - > 1,0 V: linear decreasing curve (comming from 10 V)
- 1,0 V: 600 1/min or 0 1/min (Fan off, comming from 10 V)

All measurement values are measured in the housing!

Fan has no sensor break detection!

3.2 Electrical Operating Data

Measurement conditions: Normal air density = 1,2 kg/m³; Temperature 23°C +/- 3°C; Motor axis horizontal; warm-up time before measuring 5 minutes (unless otherwise specified). In the intake and outlet area should not be any solid obstruction within 0,5 m.

$\Delta p = 0$: corresp. to free air flow (see chapter aerodynamics)

I: corresp. to arithm. mean current value

Name	Condition
U Contr. 0001	U Contr.: 10 V

The data at 5V are no FK features and need not be tested.

Features	Condition	Symbol	Values		
Voltage range		U	36 V		57 V
Nominal voltage		U_N		48 V	
Power consumption	$\Delta p = 0$	P	41 W	58 W	54 W
Tolerance	U Contr. 0010		+/- 10 %	+/- 10,0 %	+/- 10,0 %
Current consumption	$\Delta p = 0$	I	1.130 mA	1.200 mA	950 mA
Tolerance	U Contr. 0010		+/- 10,0 %	+/- 10,0 %	+/- 10,0 %
Speed	$\Delta p = 0$	n	2.740 1/min	3.000 1/min	3.000 1/min
Tolerance	U Contr. 0010		+/- 10,0 %	+/- 5,0 %	+/- 5,0 %
Starting current consumption				1.500 mA	

3.3 Electrical Interface - Output

Tacho type	/2 (open collector)
------------	---------------------

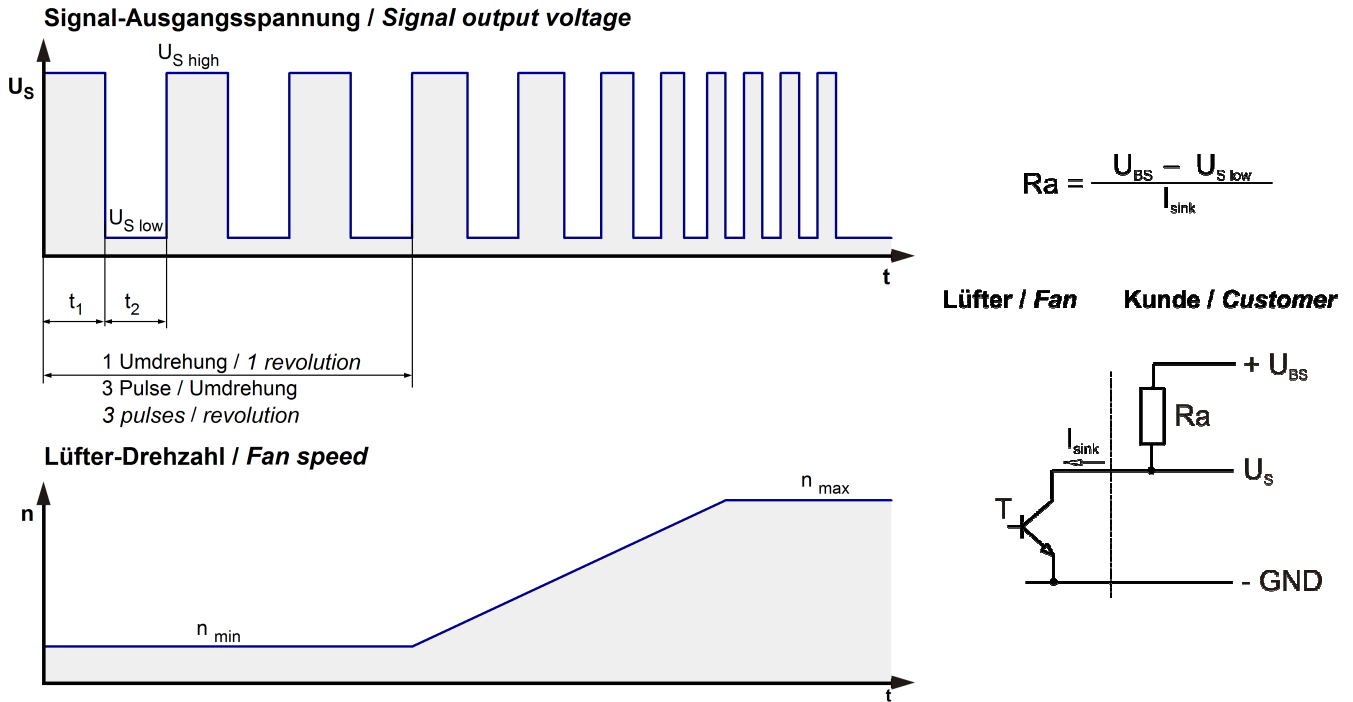

Features	Note	Values
Tacho operating voltage	U_{BS}	$\leq 57\text{ V}$
Tacho signal Low	$U_{S\ low}$	$\leq 0,4\text{ V}$
Tacho signal High	$U_{S\ high}$	$\leq 57\text{ V}$
Maximum sink current	I_{sink}	$\leq 20\text{ mA}$
Maximum source current		0 mA
External resistor	External resistor R_a from U_{BS} to U_S required. All voltages measured to GND.	
Tacho frequency	$(3 \times n) / 60$	150 Hz
Tacho isolated from motor	No	
Slew rate		$\Rightarrow 0,5\text{ V/us}$

n = revolutions per minute (1/min)

Please note:

At zero speed the tacho signal is at a static HIGH. It will be also HIGH when the fan is still spinning, but the speed control signal is set to zero speed already.
 The tacho signal is only activated after the start-up is completed.

3.4 Electrical Features

Electronic function	Speed-Controlled	
Reversed polarity protection	Rectifying diode	

Max. residual current at U_N	$I_F \leq 5 \text{ mA}$	
Locked rotor protection	Auto restart	
Locked rotor current at U_N	I_{block} approx. 1.600 mA	
Clock signal at locked rotor	t_3 / t_4 typical: 6,5 s / 10,0 s	
Internal fuse	Littelfuse NANO2 > Very Fast-Acting > 451/453 Series 3,5A / 125V (Art.No.: 045103.5MRL)	
Voltage control *)	Fan turns on at $U_B >$ or $<$ Fan turns off at $U_B < 28 \text{ V}$ or $> 68 \text{ V}$	

*) This fan has an undervoltage and overvoltage control circuit integrated which turns the motor off if the voltage is out of range.

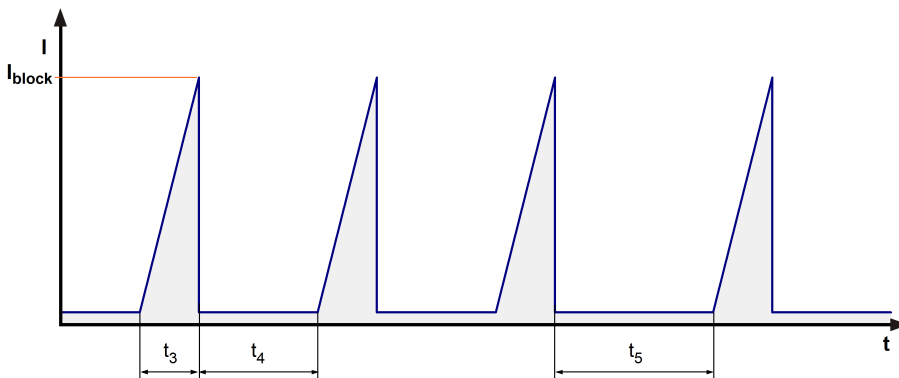

Locked rotor signal t_5 :

After 4 failed start-ups there is an extended timeout of 40,0s.

3.5 Aerodynamics

Measurement conditions:

Measured with a double chamber intake rig acc. to DIN EN ISO 5801.

Normal air density = 1,2 kg/m³; Temperature 23°C +/- 3°C;

In the intake and outlet area should not be any solid obstruction within 0,5 m. Motor shaft horizontal.

The information is only valid under the specified test conditions and may be changed by the installation conditions. If there are deviations from the standard test conditions, the characteristic values must be checked under the installed conditions. Power consumption of the fan motor when operating at normal voltage is shown. Depending on the operating conditions of the application, the power input may be higher.

a.) Operation condition:

3.000 1/min at free air flow	U Contr. 10 V		
------------------------------	---------------	--	--

Max. free-air flow ($\Delta p = 0 / \dot{V} = \text{max.}$)	620 m ³ /h	
Max. static pressure ($\Delta p = \text{max.} / \dot{V} = 0$)	440 Pa	

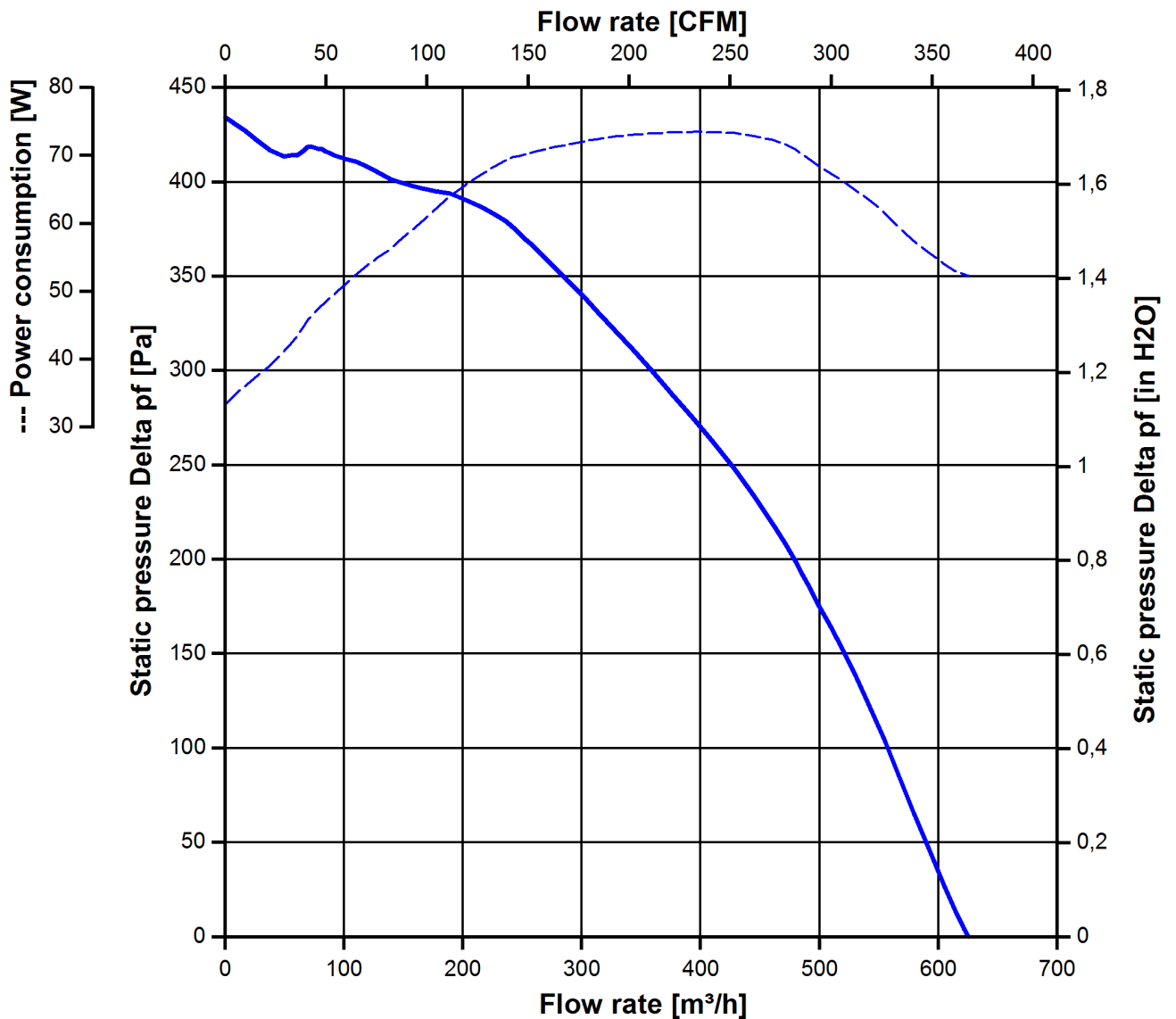

3.6 Sound Data

Measurement conditions: Sound pressure level: 1 meter distance between microphone and the air intake.
 Sound power level: Acc. to DIN 45635 part 38 (ISO 10302)
 Measured in a semianchoic chamber with a background noise level of $L_p(A) < 5 \text{ dB(A)}$
 For further measurement conditions see chapter aerodynamics.

a.) Operation condition:

3.000 1/min at free air flow	U Contr. 10 V		
------------------------------	---------------	--	--

Optimal operating point	480,0 m3/h @ 200 Pa	
Sound power level at the optimal operating point	7,3 bel(A)	
Sound pressure level at free air flow, measured in rubber bands		

4 Environment

4.1 General

Min. permitted ambient temperature TU min.	-20 °C	
Max. permitted ambient temperature TU max.	60 °C	
Min. permitted storage temperature TL min.	-40 °C	
Max. permitted storage temperature TL max.	80 °C	

4.2 Climatic Requirements

Humidity requirements	humid heat, constant; according to DIN EN 60068-2-78, 14 days	
Water exposure	None	
Dust requirements	None	
Salt fog requirements	None	

Permitted application area:

The product is intended for use in sheltered rooms with controlled temperature and controlled humidity. Directly exposure to water must be avoided.

Pollution degree 1 (according DIN EN 60664-1)

There is either no pollution or it occurs only dry, non-conductive pollution. The pollution has no negative impact.

Please require severity levels and specification parameters from the responsible development departments.

4.3 EMC

Kind	Radiated Emission; 30 MHz - 1000 MHz
According	DIN EN 55032:2016-02
Ceck accuracy / Limit	Class B
Result	Below limit Class B

Kind	Electrostatic Discharge Immunity Test
Accordinging	DIN EN 61000-4-2:2001-12
Check accuracy / Limit	Contact Discharge +/- 4 kV; Air Discharge +/- 8 kV
Result	A: The monitored function operates as designed during and after exposure to a disturbance.

Kind	Electromagnetic Field Immunity Test
Accordinging	DIN EN 61000-4-3:2006-12
Check accuracy / Limit	10 V/m; 80 - 1000 MHz; AM; m = 0,8; f = 1 kHz; 1%; t = 3 s
Result	A: The monitored function operates as designed during and after exposure to a disturbance.

Kind	Electrical Fast Transient / Burst Immunity Test
Accordinging	DIN EN 61000-4-4:2005-07
Check accuracy / Limit	+/- 2 kV on Power Lines; Coupling: POS, NEG, {PE}, ALL, 5 kHz and 100 kHz; 1 min
Result	A: The monitored function operates as designed during and after exposure to a disturbance.

Kind	Immunity to Conducted Disturbances, Induced by RF-Fields
Accordinging	DIN EN 61000-4-6:2001-12
Check accuracy / Limit	10 Vrms; 150 kHz - 80 MHz; AM; m = 0,8; f = 1 kHz; 1%; t = 3 s
Result	A: The monitored function operates as designed during and after exposure to a disturbance.

5 Safety

5.1 Electrical Safety

Dielectric strength DIN EN 60950 (VDE 0805) and DIN EN 60335 (VDE 0700) A.) Type test Measuring conditions: After 48h of storage at 95% R.H. and 25°C. No arcing or breakdown is allowed! All connections together to ground.	500 VAC / 1 Min.	
B.) Routine test Measuring conditions: At indoor climate. No arcing or breakdown is allowed! All connections together to ground.	850 VDC / 1 Sec.	
Isolation resistance Measuring conditions: After 48h of storage at 95% R.H. and 25°C measured with U=500 VDC for 1 min.	RI > 10 MOhm	
Clearance / creepage distance	1,0 mm / 1,5 mm	
Protection class	III	

5.2 Approval Tests

CE	EC Declaration of Conformity	Yes
EAC	Eurasian Conformity	Yes
UL	Underwriters Laboratories	Yes / UL507, Electric Fans
VDE	Association for Electrical, Electronic and Information Technologies	Yes / Approval acc. to EN 60950 (VDE 0805) - Information technology equipment
CSA	Canadian Standards Association	Yes / C22.2 No. 113 Fans and Ventilators
CCC	China Compulsory Certification	Yes / GB 12350 Safety Requirements for small Power Motors

6 Reliability

6.1 General

Life expectancy L10 at TU = 40 °C	85.000 h	
Life expectancy L10 at TU = 60 °C	52.500 h	
Life expectancy L10 acc. to IPC 9591 at TU = 40 °C	142.500 h	

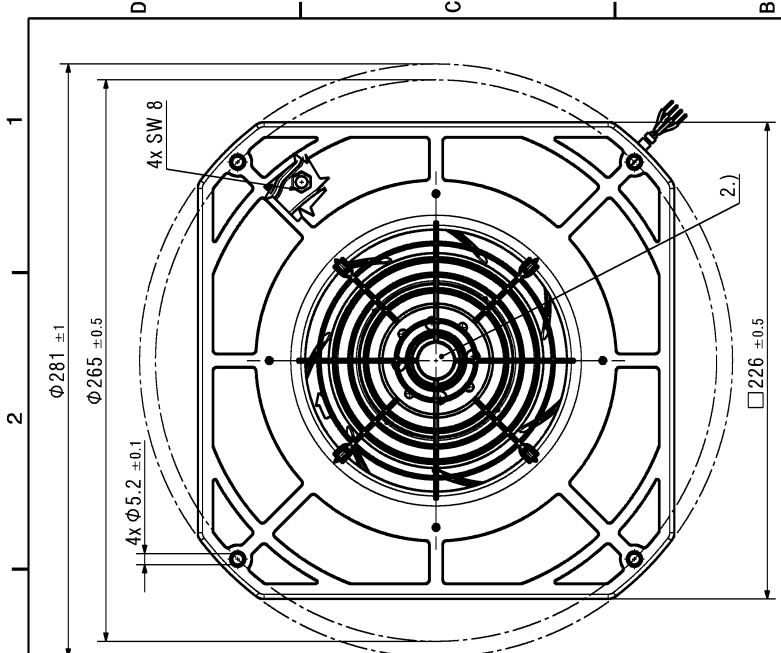

- 1.) Anzahl und Länge der Litzen, Belegung, sowie Länge des Schlauchs siehe Produktspezifikation.
- 2.) Schutzgitter, nur wenn im Lieferumfang enthalten.

- 1.) Length and number of wires, configuration and length of tube see product specification.
- 2.) Finger guard only if included in delivery.

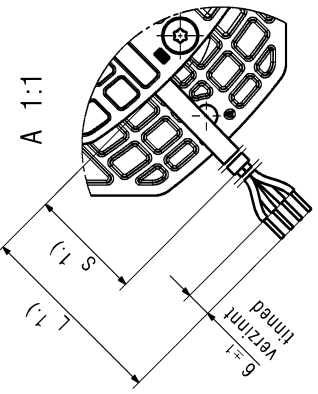
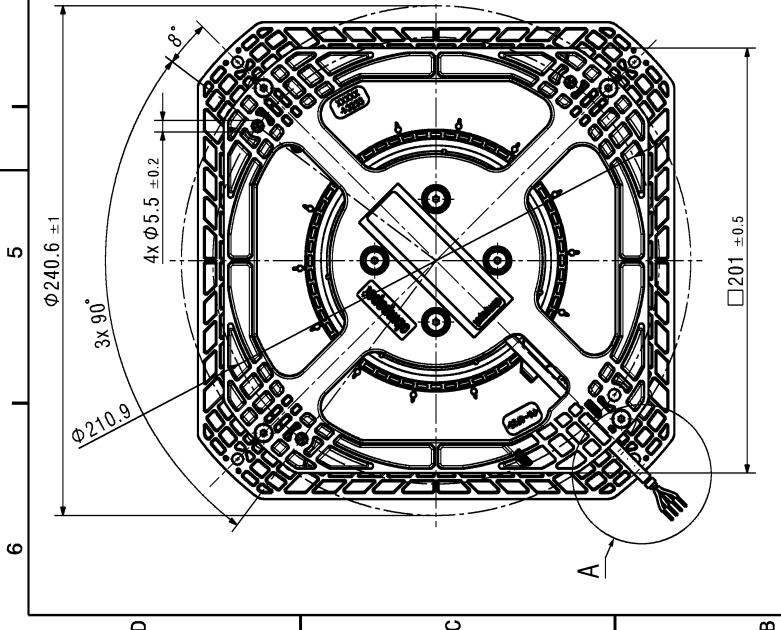
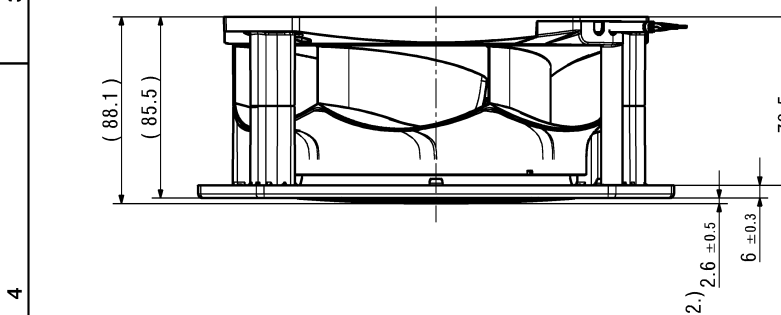

Document Status / Document-Status	CDTA-Version / CDTA-Version	CDTA-Modell / CDTA-Modell	Revision / Material	Volume / Menge
	ISSUE/1/1/1/1/1/1/1/1/1			
	Datum	Name	Titel / Title	
	Referenzmodell / Reference Model			
	Part / Bauteil	Part / Bauteil	Part / Bauteil	Part / Bauteil
	Part / Bauteil	Part / Bauteil	Part / Bauteil	Part / Bauteil
	Part / Bauteil	Part / Bauteil	Part / Bauteil	Part / Bauteil
	Part / Bauteil	Part / Bauteil	Part / Bauteil	Part / Bauteil
ebmpapst ebm-papst G. Georgiyevich & Co. KG			Form / Size	Mass / Weight

Reproduction of this document, and giving it others and using it without the written consent of ebm-papst G. Georgiyevich & Co. KG is prohibited. In the event of the grant of a patent or the registration of a utility model or design, ebm-papst G. Georgiyevich & Co. KG shall be liable for the grant of a patent or design. All rights are reserved.