

Solid State Relays Industrial, 1-Phase ZS w. LED and Built-in Varistor Types RAM1A..G

CARLO GAVAZZI

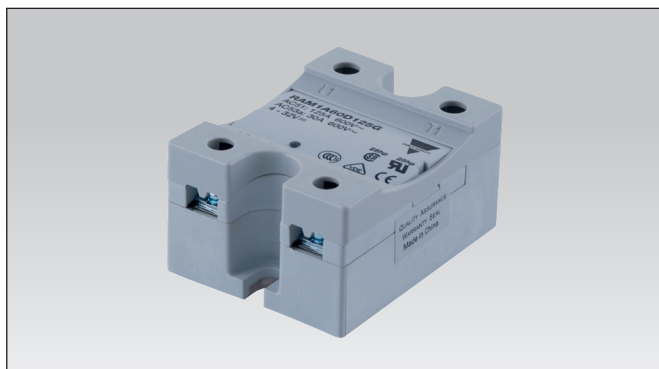

- Zero switching AC Solid State Relay
- Direct copper bonding (DCB) technology
- Operational ratings: Up to 125 AACrms and 600 VACrms
- 2 input ranges: 3-32 VDC* and 20-280 VAC/22-48 VDC
- Built-in varistor on output
- LED indication
- Clip-on IP 20 protection cover
- Self-lifting terminals
- Housing free of moulding mass
- VDE certified for Glow wire test according to EN60335-1



Product Description

The industrial, 1-phase relay with antiparallel thyristor output is the most widely used industrial SSR due to its multiple application possibilities. The relay can be used for resistive, inductive and capacitive loads. The zero switching relay switches ON when the sinusoidal curve

crosses zero and switches OFF when the current crosses zero. The built-in varistor secures transient protection. The LED indicates the status of the control input. The clip-on cover secures touch protection (IP 20). Protected output terminals can handle cables up to 16 mm².

Ordering Key

RAM 1 A 60 D 50 G

Solid State Relay _____
 Number of poles _____
 Switching mode _____
 Rated operational voltage _____
 Control voltage _____
 Rated operational current _____
 Glow wire certified (EN60335-1) _____

Type Selection

Switching mode	Rated operational voltage	Control voltage	Rated operational current	Options
A: Zero Switching (ZS)	23: 230 VACrms 60: 600 VACrms	A: 20-280 VAC/22-48 VDC D: 3 - 32 VDC*	25: 25 AACrms 50: 50 AACrms 51: 50 AACrms 100: 100 AACrms 125: 125 AACrms	G: certified for glow wire requirements of EN60335-1

* 4-32 VDC for RAM1A60...

Selection Guide

Rated operational voltage	Blocking voltage	Control voltage	Max. operational Current (with suitable heatsink)				
			25 AAC	50 AAC	50 AAC High I ² t	100 AAC	125 AAC
230 VACrms	650 V _p	3 - 32 VDC	RAM1A23D25G	RAM1A23D50G	-	-	-
		20-280 VAC/22-48 VDC	RAM1A23A25G	RAM1A23A50G	-	-	-
600 VACrms	1200 V _p	4 - 32 VDC	RAM1A60D25G	RAM1A60D50G	RAM1A60D51G	RAM1A60D100G	RAM1A60D125G
		20-280 VAC/22-48 VDC	RAM1A60A25G	RAM1A60A50G	RAM1A60A51G	RAM1A60A100G	RAM1A60A125G

General Specifications

	RAM1A23..	RAM1A60..
Operational voltage range	24 to 265 VACrms	42 to 660 VACrms
Blocking voltage	650 V _p	1200 V _p
Zero voltage turn-on	≤ 10 V	≤ 10 V
Operational frequency range	45 to 65 Hz	45 to 65 Hz
Power factor	> 0.5 @ 230 VACrms	> 0.5 @ 600 VACrms
Approvals	UR, cUR, CSA, VDE*, CCC, EAC	UR, cUR, CSA, VDE*, CCC, EAC
CE-marking	Yes	Yes**
Isolation		
Input to Output	4000 Vrms	4000 Vrms
Input and Output to case	4000 Vrms	4000 Vrms

* VDE0805, VDE0700 clause 29, 30.2.3

** Heatsink must be connected to ground

*** RAM1A..51G is UR, cUR approved only

Input Specifications

	RAM1...D..	RAM1...A..
Control voltage range		
RAM1A23...	3-32 VDC	20-280 VAC, 22-48 VDC
RAM1A60...	4-32 VDC	20-280 VAC, 22-48 VDC
Pick-up voltage @ Ta = 25°C		
RAM1A23...	2.5 VDC	18 VAC/DC
RAM1A60...	3.5 VDC	18 VAC/DC
Reverse voltage	32 VDC	-
Drop out voltage	1.2 VDC	6 VAC/DC
Input current @ max input voltage	≤ 12 mA	≤ 20 mA
Response time pick-up	1/2 cycle	≤ 12 ms
Response time drop-out	≤ 1/2 cycle	≤ 40 ms

Output Specifications

	RAM1...25	RAM1...50	RAM1...51	RAM1...100	RAM1...125
Rated operational current*					
AC51 @ Ta=25°C	25 Arms	50 Arms	50 Arms	100 Arms	125Arms
AC53a @ Ta=25°C	5 Arms	15 Arms	15 Arms	20 Arms	30Arms
Min. operational current	150 mA	250 mA	400 mA	400 mA	500mA
Rep. overload current t=1 s	< 55 AACrms	< 125 AACrms	< 125 AACrms	< 150 AACrms	< 200AACrms
Non-rep. surge current t=10 ms	325 A _p	600 A _p	800 A _p	1150 A _p	1900A _p
Off-state leakage current @ rated voltage and frequency	< 3 mArms	< 3m Arms	< 3 mArms	< 3 mArms	< 3mArms
I ² t for fusing t= 10 ms	< 525 A ² s	< 1800 A ² s	< 3200 A ² s	< 6600 A ² s	<18000A ² s
Critical dV/dt off-state min.	1000 V/μs	1000 V/μs	1000 V/μs	1000 V/μs	1000V/μs
Endurance testing acc. to UL 508	100,000 cycles	100,000 cycles	6,000 cycles	6,000 cycles	6,000 cycles

Note: UL requirement for General Use Endurance Testing is 6,000 cycles

* Refer to Heatsinks dimensions section for selection of a suitable heatsink

Motor Ratings*: HP (UL508)

	230 VAC	400 VAC	480 VAC	600 VAC
RAM1..25	1.5 HP	3 HP	3 HP	5 HP
RAM1..50, 51	3 HP	5 HP	7.5 HP	10 HP
RAM1..100	7.5 HP	15 HP	20 HP	25 HP
RAM1..125	10 HP	15 HP	25 HP	30 HP

* with suitable heatsink

Output Power Dissipation

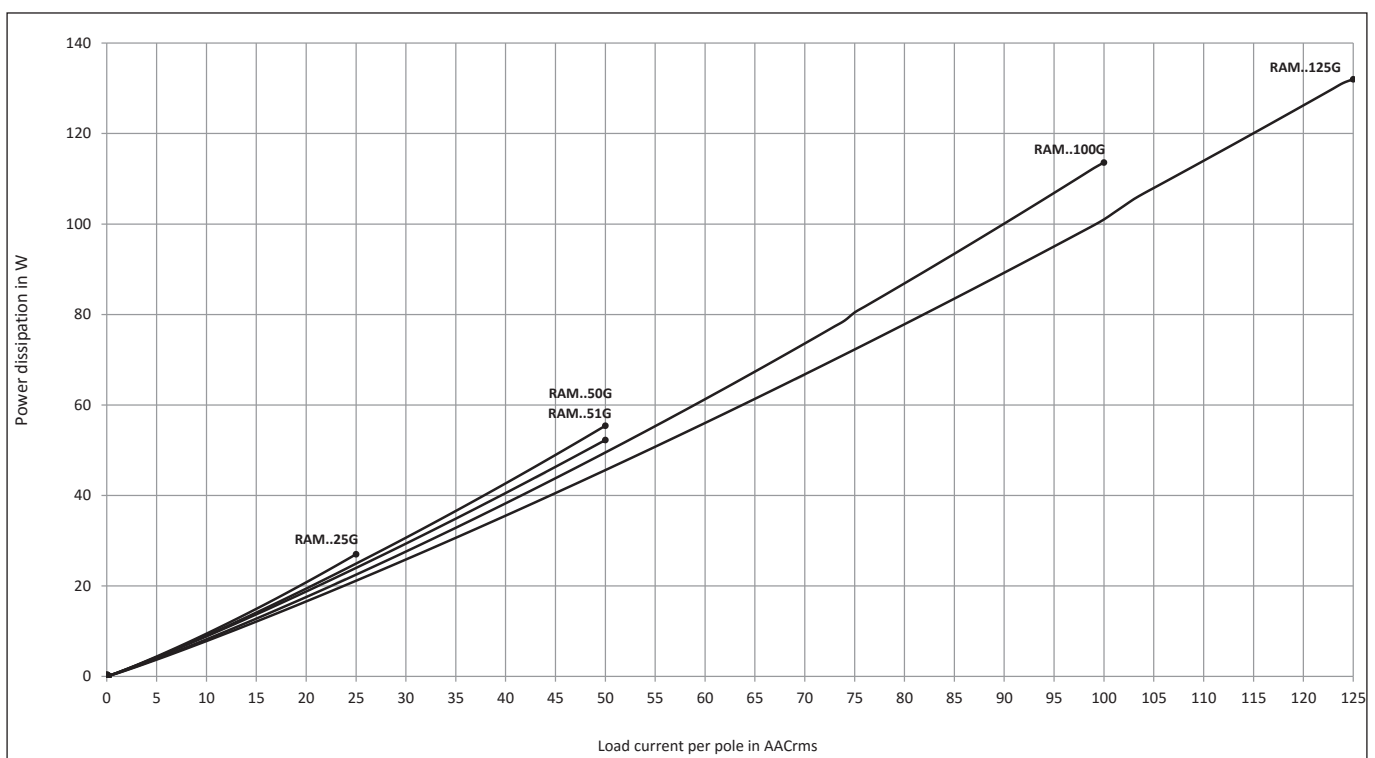

Electromagnetic Compatibility

Immunity	EN60947-4-3	Radiated Radio Frequency	Immunity IEC/EN 61000-4-3
Electrostatic Discharge (ESD)		10 V/m, 80 - 1000 MHz	Performance Criteria 1
Immunity	IEC/EN 61000-4-2	10 V/m, 1.4 - 2.0 GHz	Performance Criteria 1
Air discharge, 8 kV	Performance Criteria 2	3 V/m, 2.0 - 2.7 GHz	Performance Criteria 1
Contact, 4 kV	Performance Criteria 2	Conducted Radio Frequency Immunity	IEC/EN 61000-4-6
Electrical Fast Transient (Burst) Immunity		10 V/m, 0.15 - 80 MHz	Performance Criteria 1
Output: 2 kV, 5 kHz	IEC/EN 61000-4-4	Voltage Dips Immunity	IEC/EN 61000-4-11
Input: 1 kV, 5 kHz	Performance Criteria 1	0% for 0.5, 1 cycle	Performance Criteria 2
	Performance Criteria 1	40% for 10 cycles	Performance Criteria 2
Electrical Surge Immunity	IEC/EN 61000-4-5	70% for 25 cycles	Performance Criteria 2
Output, line to line, 2 kV	Performance Criteria 2	80% for 250 cycles	Performance Criteria 2
Output, line to earth, 2 kV	Performance Criteria 2	Voltage Interruptions Immunity	IEC/EN 61000-4-11
Input, line to line, 1 kV	Performance Criteria 2	0% for 5000 ms	Performance Criteria 2
Input, line to earth, 2 kV	Performance Criteria 2		
EMC Emission	EN60947-4-3	Radio Interference	
Radio Interference		Field Emission (Radiated)	IEC/EN 55011
Voltage Emission (Conducted)	IEC/EN 55011	30 - 1000 MHz	Class B
0.15 - 30 MHz	Class A (industrial) with filters IEC/EN 60947-4-3 Class A (no filtering needed up to 75AAC)		





Notes:

- Control input lines must be installed together to maintain products' susceptibility to Radio Frequency interference.
- Performance Criteria 1: No degradation of performance or loss of function is allowed when the product is operated as intended.
- Performance Criteria 2: During the test, degradation of performance or partial loss of function is allowed. However, when the test is complete the product should return operating as intended by itself.
- Performance Criteria 3: Temporary loss of function is allowed, provided the function can be restored by manual operation of the controls.

Housing Specifications

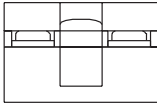
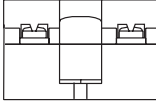
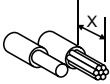
Weight 25 A, 50 A 100 A, 125 A	Approx. 60 g Approx. 100 g	Glow wire	850°C, 750°C/2s according to EN60335-1
Housing material	PA66, RAL7035	Relay Mounting screws Mounting torque	M5 1.5-2.0 Nm
Baseplate 25 A, 50 A 100 A, 125 A	Aluminium Copper, nickel-plated		

Connection Specifications

Connection terminals	L1, T1	A1, A2			
					
Stripping length (X)	12 mm	8 mm			
Connection Type	M5 screw with captivated washer	M3 screw with captivated washer			
Rigid (solid & stranded) UR rated data		1x 2.5 - 6.0 mm ² 1x 14 - 10 AWG	2x 2.5 - 6.0 mm ² 2x 14 - 10 AWG	1x 0.5 - 2.5 mm ² 1x 18 - 12 AWG	2x 0.5 - 2.5 mm ² 2x 18 - 12 AWG
Flexible with end sleeve		1x 1.0 - 4.0 mm ² 1x 18 - 12 AWG	2x 1.0 - 2.5 mm ² 2x 2.5 - 4.0 mm ² 2x 18 - 14 AWG 2x 14 - 12 AWG	1x 0.5 - 2.5 mm ² 1x 18 - 12 AWG	2x 0.5 - 2.5 mm ² 2x 18 - 12 AWG
Flexible without end sleeve		1x 1.0 - 6.0 mm ² 1x 18 - 10 AWG	2x 1.0 - 2.5 mm ² 2x 2.5 - 6.0 mm ² 2x 18 - 14 AWG 2x 14 - 10 AWG		
Torque specification		Pozidrive 2 2.4 Nm (21.2 lb-in)	Pozidrive 1 0.5 Nm (4.4 lb-in)		
Aperture for termination lug		12 mm	7.5 mm		

Functional Diagram

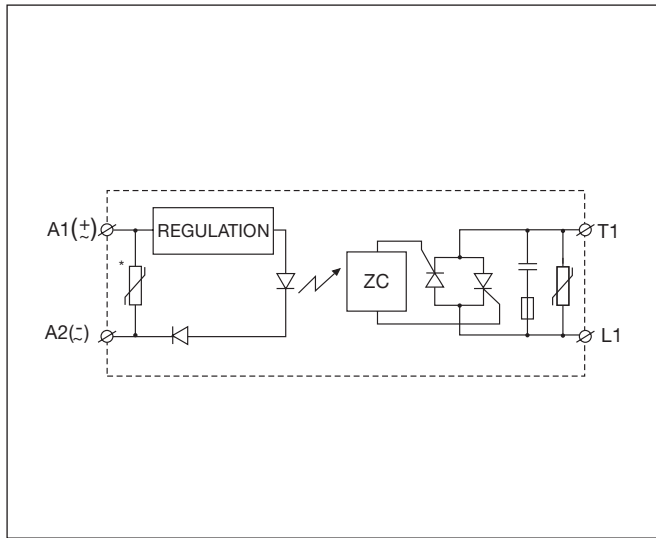

* Varistor across input applies to AC control versions only.

Dimensions

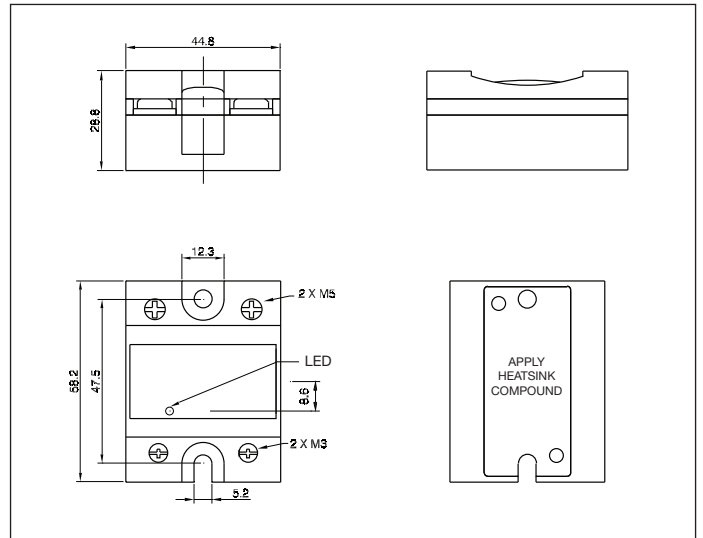

All dimensions in mm.

Connection Diagram

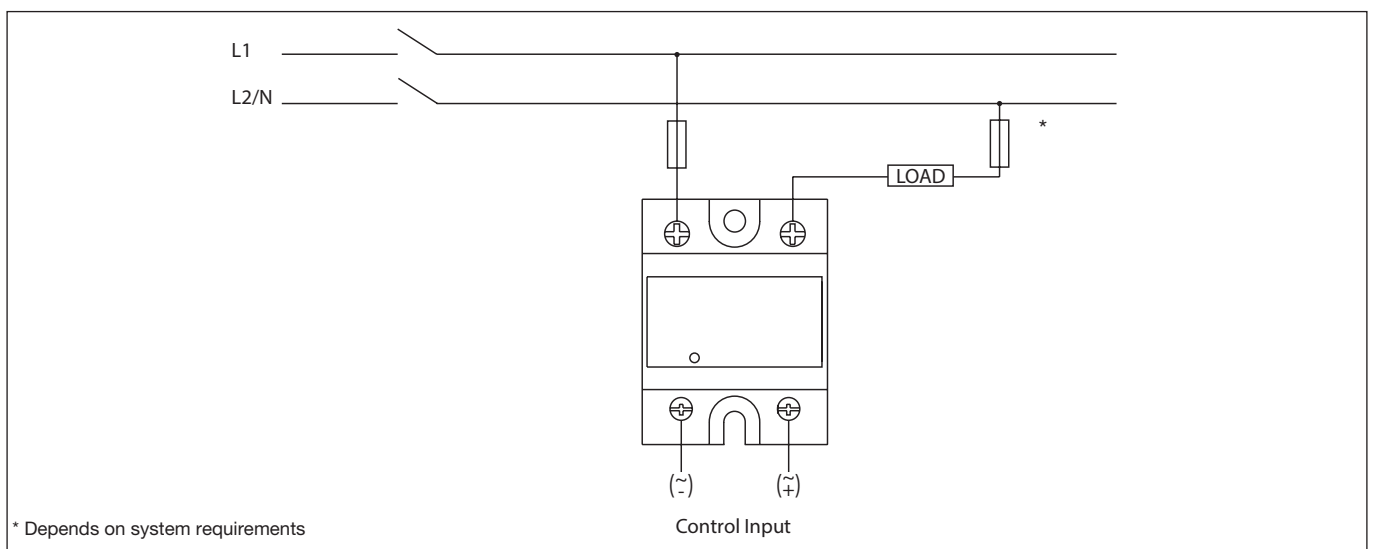

* Depends on system requirements



Heatsink Dimensions (load current versus ambient temperature)

RAM..25

Load current [A]	Thermal resistance [°C/W]						
	20	30	40	50	60	70	80
25.0	3.23	2.80	2.37	1.94	1.51	1.09	0.66
22.5	3.70	3.21	2.73	2.24	1.75	1.26	0.78
20.0	4.30	3.74	3.17	2.61	2.05	1.49	0.92
17.5	5.07	4.41	3.76	3.10	2.44	1.78	1.12
15.0	6.12	5.33	4.54	3.75	2.96	2.17	1.38
12.5	7.58	6.61	5.64	4.66	3.69	2.72	1.75
10.0	9.80	8.55	7.30	6.05	4.80	3.55	2.30
7.5	13.5	11.80	10.09	8.37	6.66	4.94	3.23
5.0	-	18.3	15.7	13.04	10.39	7.74	5.09
2.5	-	-	-	-	-	16.2	10.7

RAM..50, 51

Load current [A]	Thermal resistance [°C/W]						
	20	30	40	50	60	70	80
50.0	1.25	1.07	0.88	0.70	0.52	0.34	0.16
45.0	1.46	1.25	1.04	0.84	0.63	0.42	0.21
40.0	1.73	1.49	1.25	1.01	0.77	0.52	0.28
35.0	2.08	1.80	1.51	1.23	0.94	0.66	0.37
30.0	2.56	2.22	1.87	1.53	1.18	0.84	0.49
25.0	3.24	2.81	2.38	1.95	1.52	1.09	0.66
20.0	4.26	3.71	3.15	2.59	2.03	1.47	0.92
15.0	5.99	5.22	4.45	3.67	2.90	2.12	1.35
10.0	9.49	8.27	7.06	5.85	4.64	3.43	2.22
5.0	-	17.5	15.0	12.4	9.91	7.39	4.86

Junction to ambient thermal resistance, $R_{th\ j-a}$	< 20.0	°C/W
Junction to case thermal resistance, $R_{th\ j-c}$	< 0.80	°C/W
Case to heatsink thermal resistance, $R_{th\ c-s^2}$	< 0.20	°C/W
Maximum allowable case temperature	100	°C
Maximum allowable junction temperature	125	°C

Junction to ambient thermal resistance, $R_{th\ j-a}$	< 20.0	°C/W
Junction to case thermal resistance, $R_{th\ j-c}$	< 0.50	°C/W
Case to heatsink thermal resistance, $R_{th\ c-s^2}$	< 0.20	°C/W
Maximum allowable case temperature	100	°C
Maximum allowable junction temperature	125	°C

RAM..100

Load current [A]	Thermal resistance [°C/W]						
	20	30	40	50	60	70	80
100.0	0.60	0.52	0.43	0.34	0.26	0.17	0.09
90.0	0.74	0.64	0.54	0.44	0.34	0.24	0.14
80.0	0.91	0.79	0.68	0.56	0.45	0.33	0.22
70.0	1.09	0.96	0.82	0.68	0.55	0.41	0.27
60.0	1.33	1.16	1.00	0.83	0.66	0.50	0.33
50.0	1.66	1.45	1.24	1.04	0.83	0.62	0.41
40.0	2.16	1.89	1.62	1.35	1.08	0.81	0.54
30.0	3.01	2.64	2.26	1.88	1.51	1.13	0.75
20.0	4.73	4.14	3.55	2.96	2.37	1.78	1.18
10.0	9.94	8.70	7.45	6.21	4.97	3.73	2.48

RAM..125

Load current [A]	Thermal resistance [°C/W]						
	20	30	40	50	60	70	80
125.0	0.63	0.55	0.47	0.40	0.32	0.24	0.16
112.5	0.73	0.64	0.54	0.45	0.36	0.27	0.18
100.0	0.84	0.74	0.63	0.53	0.42	0.32	0.21
87.5	0.99	0.87	0.74	0.62	0.50	0.37	0.25
75.0	1.20	1.05	0.90	0.75	0.60	0.45	0.30
62.5	1.48	1.30	1.11	0.93	0.74	0.56	0.37
50.0	1.92	1.68	1.44	1.20	0.96	0.72	0.48
37.5	2.65	2.32	1.98	1.65	1.32	0.99	0.66
25.0	4.12	3.60	3.09	2.57	2.06	1.54	1.03
12.5	8.55	7.48	6.41	5.34	4.27	3.21	2.14

Junction to ambient thermal resistance, $R_{th\ j-a}$	< 20.0	°C/W
Junction to case thermal resistance, $R_{th\ j-c}$	< 0.35	°C/W
Case to heatsink thermal resistance, $R_{th\ c-s^2}$	< 0.10	°C/W
Maximum allowable heatsink temperature	100	°C
Maximum allowable junction temperature	125	°C

Junction to ambient thermal resistance, $R_{th\ j-a}$	< 20.0	°C/W
Junction to case thermal resistance, $R_{th\ j-c}$	< 0.30	°C/W
Case to heatsink thermal resistance, $R_{th\ c-s^2}$	< 0.10	°C/W
Maximum allowable heatsink temperature	100	°C
Maximum allowable junction temperature	125	°C

Heatsink Selection

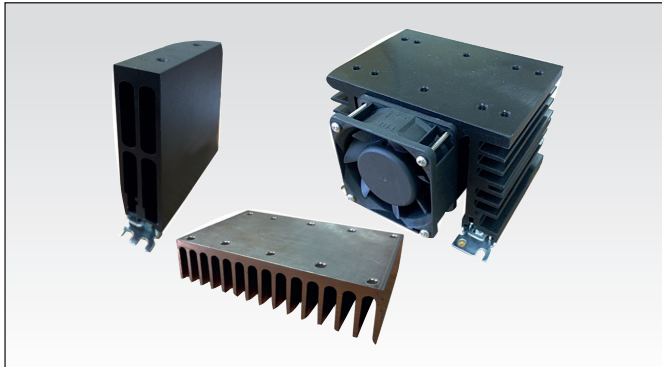

Ordering Key

RHS..

- Heatsinks and fans
- 5.40°C/W to 0.12°C/W thermal resistance
- DIN, panel or thru wall mounting
- Single or multiple SSR mounting

Heatsink Range Overview:

http://www.productselection.net/PDF/UK/ssr_accessories.pdf

Heatsink Selector Tool:

<http://www.productselection.net/heatsink/heatsinkselector.php?LANG=UK>

Thermal Specifications

Operating temperature	-40° to +80°C (-40° to +176°F)
Storage temperature	-40° to +100°C (-40° to +212°F)
Junction temperature	≤ 125°C (257°F)

Note: The thermal resistance values indicated in the tables above are applicable if a fine layer of thermal paste, HTS02S, is applied between heatsink and SSR.

Short Circuit Protection

Protection Co-ordination, Type 1 vs. Type 2:

Type 1 protection implies that after a short circuit, the device under test will no longer be in a functioning state. In type 2 co-ordination the device under test will still be functional after the short circuit. In both cases, however, the short circuit has to be interrupted. The fuse between enclosure and supply shall not open. The door or cover of the enclosure shall not be blown open. There shall be no damage to conductors of terminals and the conductors shall not separate from terminals. There shall be no breakage or cracking of insulating bases to the extent that the integrity of the mounting of live parts is impaired. Discharge of parts or any risk of fire shall not occur.

The product variants listed in the table hereunder are suitable for use on a circuit capable of delivering not more than 65,000A rms Symmetrical Amperes, 600Volts maximum when protected by fuses. Tests at 65,000A were performed with Class J, fast acting: please refer to the table below for maximum allowed ampere rating of the fuse. Use fuses only.

Co-ordination type 1 (UL508)

Part No.	Prospective short circuit current [kArms]	Max. fuse size [A]	Class/ Model	Voltage [VAC]
RAM1..25..	65	30	J or CC	600
RAM1..50.., 51..	65	30 20	J HSJ20 (Mersen)*	600 600
RAM1..100..	65	80 60	J HSJ60 (Mersen)*	600 600
RAM1..125..	65	125 60	J HSJ60 (Mersen)*	600 600

Co-ordination type 2 (IEC/EN60947-4-3)

Part No.	Prospective short circuit current [kArms]	Max. fuse size [A]	Brand	Model	Size
RAM1.23..25..	10	25	Mersen*	6.9gRB 10-25	10.3 x 38
RAM1.60..25..	10	20	Mersen*	6.9gRB 10-20	10.3 x 38
RAM1.23..50.., 51..	10	50	Mersen*	6.9zz CP gRC 14x51/50	14 x 51
RAM1.60..50.., 51..	10	50	Mersen*	6.9zz CP gRC 22x58/50	22 x 58
RAM1.60.100..	10	80	Mersen*	6.9zz CP gRC 22x58/80	22 x 58
RAM1.60.125..	10	125	Mersen*	6.921 CP URGD 27x60/125	27 x 60

zz = 00, without fuse trip indication

zz = 21, with fuse trip indication

* formerly Ferraz Shawmut

Type 2 Protection with Miniature Circuit Breakers (M.C.B.s)

Solid State Relay type	ABB Model no. for Z - type M. C. B. (rated current)	ABB Model no. for B - type M. C. B. (rated current)	Wire cross sectional area [mm ²]	Minimum length of Cu wire conductor [m]*
RAM..25..	1-pole			
	S201-Z4 (4A)	S201-B2 (2A)	1.0	21.0
	S201-Z6 UC (6A)	S201-B2 (2A)	1.0	21.0
			1.5	31.5
RAM..50.. RAM..51..	1-pole			
	S201-Z10 (10A)	S201-B4 (4A)	1.0	7.6
			1.5	11.4
			2.5	19.0
	S201-Z16 (16A)	S201-B6 (6A)	1.0	5.2
			1.5	7.8
			2.5	13.0
			4.0	20.8
	S201-Z20 (20A)	S201-B10 (10A)	1.5	12.6
			2.5	21.0
	S201-Z25 (25A)	S201-B13 (13A)	2.5	25.0
			4.0	40.0
	RAM..100..	2-pole		
S202-Z25 (25A)		S202-B13 (13A)	2.5	19.0
			4.0	30.4
1-pole				
S201-Z20 (20A)		S201-B10 (10A)	1.5	4.2
			2.5	7.0
			4.0	11.2
S201-Z32 (32A)		S201-B16 (16A)	2.5	13.0
			4.0	20.8
			6.0	31.2
2-pole				
S202-Z20 (20A)	S202-B10 (10A)	1.5	1.8	
		2.5	3.0	
		4.0	4.8	
S202-Z32 (32A)	S202-B16 (16A)	2.5	5.0	
		4.0	8.0	
		6.0	12.0	
		10.0	20.0	
S202-Z50 (50A)	S202-B25 (25A)	4.0	14.8	
		6.0	22.2	
		10.0	37.0	
RAM..125..	1-pole			
	S201-Z50 (50A)	S201-B25 (25A)	4.0	4.8
			6.0	7.2
			10.0	12.0
			16.0	19.2
	S201-Z63 (63A)	S201-B32 (32A)	6.0	7.2
			10.0	12.0
			16.0	19.2

* Between MCB and Load (including return path which goes back to the mains).

Note: A prospective current of 6kA and a 230/400V power supply system is assumed for the above suggested specifications. For cables with different cross section than those mentioned above please consult Carlo Gavazzi's Technical Support Group.



Environmental Information

The declaration in this section is prepared in compliance with People’s Republic of China Electronic Industry Standard SJ/T11364-2014: Marking for the Restricted Use of Hazardous Substances in Electronic and Electrical Products.

Part Name	Toxic or Harardous Substances and Elements					
	Lead (Pb)	Mercury (Hg)	Cadmium (Cd)	Hexavalent Chromium (Cr(VI))	Polybrominated biphenyls (PBB)	Polybrominated diphenyl ethers (PBDE)
Power Unit Assembly	x	○	○	○	○	○

O: Indicates that said hazardous substance contained in homogeneous materials for this part are below the limit requirement of GB/T 26572.

X: Indicates that said hazardous substance contained in one of the homogeneous materials used for this part is above the limit requirement of GB/T 26572.

环境特性

这份申明根据中华人民共和国电子工业标准 SJ/T11364-2014：标注在电子电气产品中限定使用的有害物质

零件名称	有毒或有害物质与元素					
	铅 (Pb)	汞 (Hg)	镉 (Cd)	六价铬 (Cr(VI))	多溴化联苯 (PBB)	多溴联苯醚 (PBDE)
功率单元	x	○	○	○	○	○

O:此零件所有材料中含有的该有害物低于GB/T 26572的限定。

X: 此零件某种材料中含有的该有害物高于GB/T 26572的限定。



FASTON terminals



- Faston tabs
- Tab dimensions according to DIN 46342 part 1
- Pure tin-plated brass

Faston terminals in packs of 20

RS, RM Solid State Relay
Tab orientation

RM48 **

F4 *

- * 0: flach (0°)
- 4: abgewinkelt (45°)

- ** 48: 4.8mm faston for input
- 63: 6.3mm faston for output

Fork Terminals

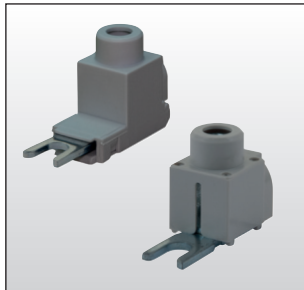

- Terminal adaptors for 35mm² cable
- Type RM635FK
- Pack size: 10 pieces

Ordering Key

RM terminal adaptor
Touch protected (optional)

RM635FK

P

Other Accessories

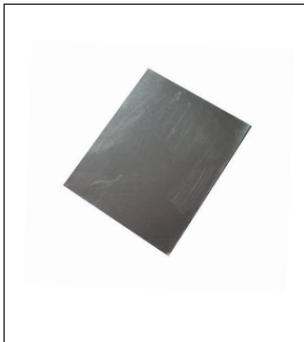

- Graphite thermal pad with adhesive on one side
- Type KK071CUT
- Dimensions: 35 x 43 x 0.25mm
- Packing quantity: 50pcs.

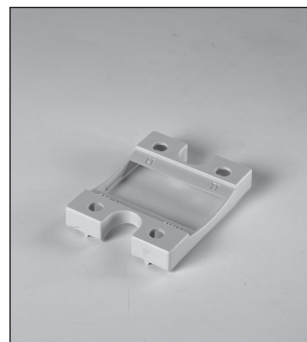

- Touch safety cover
- Type RMIP20
- IP20 protection degree
- Pack size: 20 pieces

All accessories can be ordered pre-assembled with Solid State Relays.
Other accessories include DIN rail adaptors, fuses, varistors and spacers.

For further information refer to Accessories datasheets at:
www.productselection.net/PDF/UK/SSR_Accessories.pdf