

User's Guide

QL-700

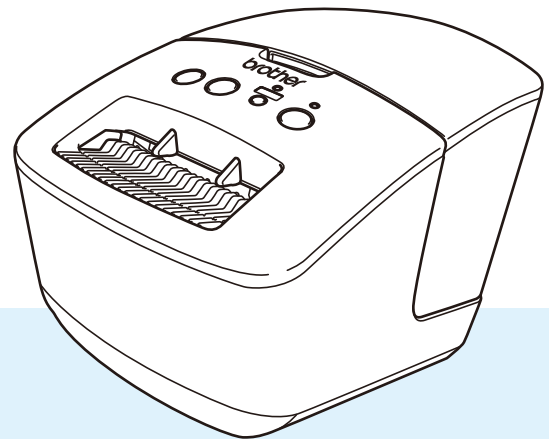

Read the *Product Safety Guide* first, then read the *Quick Setup Guide* for the correct setup procedure. After reading this guide, keep it in a safe place for quick reference.

Introduction

Important Notice

- The contents of this document and the specifications of this product are subject to change without notice.
- Brother reserves the right to make changes without notice in the specifications and materials contained herein and shall not be responsible for any damages (including consequential) caused by reliance on the materials presented, including but not limited to typographical and other errors relating to the publications.
- Screen images in this document may differ depending on your computer's operating system, your product model, and software version.
- Before using the label printer, make sure you read all the documents included with the printer for information about safety and operation.
- The printer shown in the illustrations may be different from your printer.
- The available supplies may vary depending on the country.

Available Manuals

Visit the Brother support website at support.brother.com and click **Manuals** on your model page to download the latest manuals.



Product Safety Guide ¹	This guide provides safety information; read it before you use the printer.
Quick Setup Guide ¹	This guide provides basic information about using the printer.
User's Guide ²	This guide provides additional information about the printer settings and operations, troubleshooting tips, and maintenance instructions.

¹ Printed manual in the box

² PDF manual on the Brother support website



Symbols Used in This Guide

The following symbols are used throughout this guide:

 WARNING	Indicates a potentially hazardous situation which, if the product is handled without following the warnings and instructions, could result in death or serious injuries.
 CAUTION	Indicates a potentially hazardous situation which, if not avoided, may result in minor or moderate injuries.
IMPORTANT	Indicates information or directions that should be followed. Ignoring them may result in damage, or failed operations.
 Note	Indicates notes that provide information or directions that can help you better understand and use the product more efficiently.

General Precautions

DK Roll (DK Label and DK Tape)

- Use only genuine Brother accessories and supplies (with ,  marks). DO NOT use any unauthorised accessories or supplies.
- If the label is attached to a wet, dirty, or oily surface, it may peel off easily. Before applying the label, clean the surface to which the label will be applied.
- DK Rolls use thermal paper or film that can fade in colour or peel off surfaces if exposed to ultraviolet light, wind, or rain.
- DO NOT expose the DK Rolls to direct sunlight, high temperatures, high humidity, or dust. Store in a cool, dark place. Use the DK Rolls soon after opening the package.
- Scratching the printed surface of the label with your finger nails or metal objects, or touching the printed surface with damp or wet hands can cause the colour to change or fade.
- DO NOT apply labels to any persons, animals, or plants. In addition, never apply labels to public or private property without permission.
- As the end of the DK Roll is designed to not adhere to the label spool, the last label may not be cut correctly. If this happens, remove the remaining labels, insert a new DK Roll, and reprint the last label.
Note: To account for this, the number of DK Labels included on each DK Roll may be more than indicated on the package.
- When a label is removed after being applied to a surface, a portion of the label may remain applied.
- Prior to using CD/DVD labels, be sure to follow the instructions in your CD/DVD player's instruction guide regarding applying CD/DVD labels.
- DO NOT use CD/DVD labels in a slot loading CD/DVD player.
- DO NOT peel off the CD/DVD label once it is applied to the CD/DVD, a thin surface layer may come off, resulting in damage to the disc.
- DO NOT apply CD/DVD labels to CDs/DVDs designed for use with inkjet printers. Labels peel off these discs easily and using discs with peeling labels can result in loss or damage of data.
- When applying CD/DVD labels, use the applicator included with the CD/DVD label rolls. Failure to do so could cause damage to the CD/DVD player.
- Users shall take full responsibility for applying CD/DVD labels. Brother accepts no responsibility for any loss or damage of data caused by the inappropriate use of CD/DVD labels.
- Be careful not to drop the DK Roll.
- DK Rolls use thermal paper and thermal film. Both the label and print will fade with sunlight and heat. DO NOT use DK Rolls for any outdoor use that requires durability.
- Depending on the area, material, and environmental conditions, the label may unpeel or become irremovable, or the colour of the label may change or be transferred to other objects. Before applying the label, check the environmental conditions and the material. Test the label by affixing a small piece of it to an inconspicuous area of the intended surface.

Section I Basic Operations

1	Set Up the Label Printer	2
	Parts Description	2
	Front	2
	Rear	3
	Connect the Power Cord	4
	Load the DK Roll.....	5
	Turn Power On/Off.....	7
2	Print Using a Computer (P-touch Editor)	8
	Install the Printer Driver and Software on a Computer	8
	Connect the Label Printer to a Computer	8
	Print from a Computer	9
	Available Applications.....	9
	Create Labels from Your Computer.....	10
	Attach Labels.....	11
	Install the Printer Driver and Software on a Computer not connected to the Internet	11

Section II Application

3	How to Use P-touch Editor	13
	For Windows.....	13
	Starting P-touch Editor	13
	Printing with P-touch Editor	15
	For Mac.....	17
	Start P-touch Editor	17
	Operation modes	18
4	How to Use P-touch Editor Lite (Windows only)	19
5	How to Use the P-touch Address Book (Windows only)	23
	Start the P-touch Address Book	23
	Create a New Contact	26
6	How to Use P-touch Library (Windows only)	28
	Start P-touch Library.....	28
	Open and Edit Templates	30
	Print Templates.....	31
	Search for Templates	32

7	How to Update P-touch Software	34
	Update P-touch Editor and P-touch Address Book (Windows only).....	34
	Update the Firmware	36
	For Windows.....	36
	For Mac	38
Section III Appendix		
8	Reset the Label Printer	41
	Reset Device Settings to the Factory Settings Using the Label Printer Buttons.....	41
9	Maintenance	42
	Clean the Exterior of the Unit.....	42
	Clean the Label Outlet.....	42
	Self-Cleaning Print Head	42
10	Troubleshooting	43
	Overview.....	43
	Driver Installation Problems (for Windows).....	43
	LED Indications.....	44
	Printing Problems	46
	Version Information	49
11	Product Specifications	50
	Label Printer Specifications	50
	Operating environment	50
12	Printing directly from other Windows software	51
	Setting the Printer Driver	51
	Basic Tab.....	52
	Advanced Tab	52
	Other Tab	53
	Printing from other Windows software.....	54



Basic Operations

Set Up the Label Printer	2
Print Using a Computer (P-touch Editor)	8

1

Set Up the Label Printer

1

Parts Description

Front

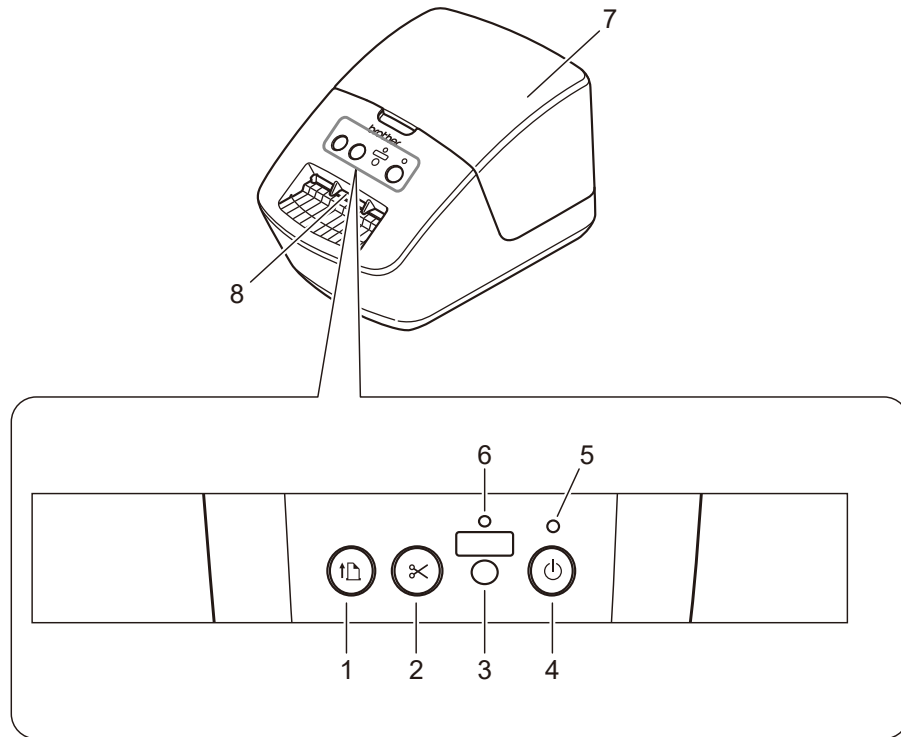

- 1 Feed Button
- 2 Cutter Button
- 3 Editor Lite Button
- 4 Power Button

- 5 Status LED
- 6 Editor Lite LED
- 7 DK Roll Compartment Cover
- 8 Label Output Slot

Rear

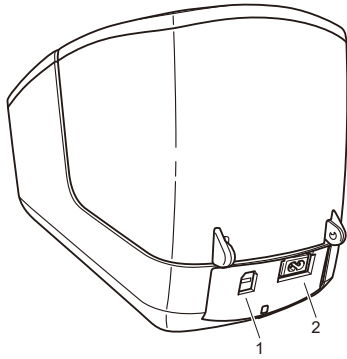

- 1 USB Port
- 2 AC Power Port

Connect the Power Cord

Connect the AC Power Cord to the printer. Then, plug the AC Power Cord into an electrical socket.

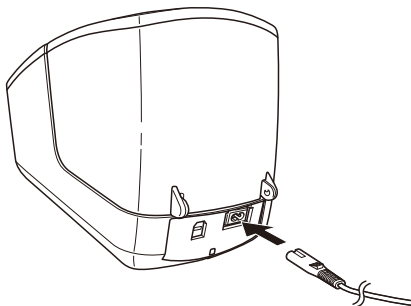

IMPORTANT

Do not use your printer in areas where the power source voltage is different from the printer's specified voltage. For more information, see *Product Specifications* on page 50.

Load the DK Roll

- 1 Hold the printer by the front, and firmly lift the DK Roll Compartment Cover to open it.

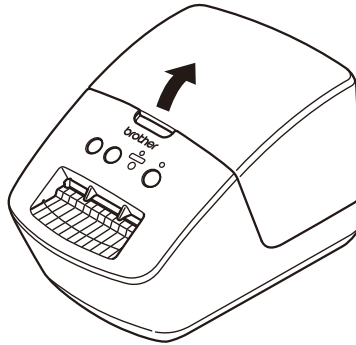

- 2 Place the DK Roll into the Roll Spool Guide (1).
 - Make sure that the Roll Spool Arm (2) is inserted firmly in the Roll Spool Guide.
 - Make sure the Stabiliser (3) slides into the notch of the printer.

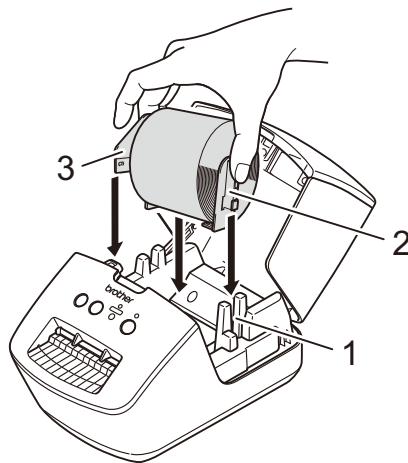

- 3 Thread the DK Roll through the printer.
 - Align the edge of the DK Roll with the upright edge of the Label Output Slot.
 - Check that the DK Roll is threaded straight so that the labels will not be skewed.

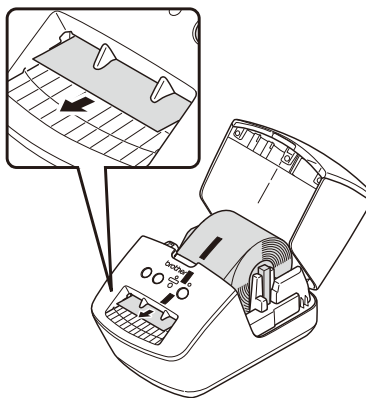

- Push the first label through the Label Output Slot until the end comes out of the Slot as shown.

- 4 Close the DK Roll Compartment Cover.

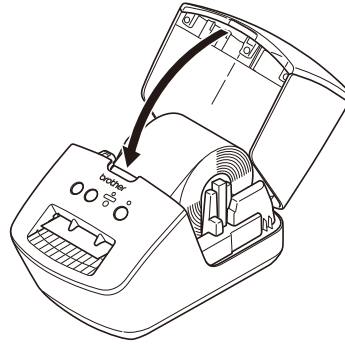

IMPORTANT

- Do not leave any printed labels in the printer. Doing so will cause the labels to jam.
 - When not in use, remove any DK Rolls from inside the printer and close the DK Roll Compartment Cover to prevent dust and debris from accumulating in the printer.
-

Turn Power On/Off

On: Press the Power (⏻) Button to turn the printer On. The Status LED turns green.

IMPORTANT

- If the DK Die-cut Label is installed, the end of the label will be aligned automatically after you press the Power Button.
 - If a different label is set, press the Feed (↓↵) Button to align the end of the label.
-

Off: Press and hold the Power (⏻) Button again to turn the printer Off.

Install the Printer Driver and Software on a Computer

To print from your Windows computer or Mac, install the printer driver, P-touch Editor, and other applications on your computer.

Software for Windows:

Printer Driver, P-touch Editor, P-touch Address Book, P-touch Update Software

Software for Mac:

Printer Driver, P-touch Editor, P-touch Update Software



Note

If the computer is not connected to the Internet, see *Install the Printer Driver and Software on a Computer not connected to the Internet* on page 11.

- 1 Visit install.brother and download the Software Installer for the latest software and manuals.
- 2 Double-click the downloaded EXE file (for Windows) or DMG file (for Mac), and follow the on-screen instructions to proceed with the installation.
- 3 Close the dialog box when the installation is complete.

Connect the Label Printer to a Computer

You can connect the printer to a Windows computer or Mac via a USB cable.

- 1 Make sure the printer is turned Off before connecting the USB cable.
- 2 Connect the USB cable to the USB Port on the back of the printer, and then to your computer.

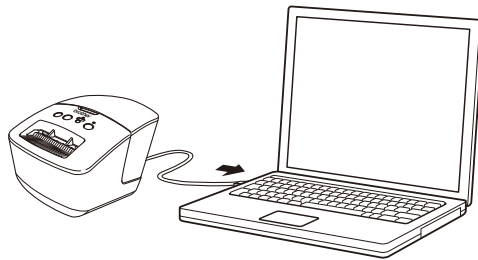

- 3 Turn the printer On.

Print from a Computer

Available Applications

To use the printer effectively, a number of applications and functions are available.

You must install the printer driver to use these applications.

Visit install.brother and download the installer for the applications and printer driver.

Application	Windows	Mac	Features
P-touch Editor	✓	✓	Designs and prints custom labels with built-in drawing tools, text using different fonts and styles, imported graphic images, and barcodes.
P-touch Library	✓		Manages and prints P-touch Editor templates. You can use P-touch Library to print templates. This application is installed with P-touch Editor.
P-touch Update Software	✓	✓	Updates software to the latest version.
P-touch Address Book	✓		Prints address labels using an address database.

Create Labels from Your Computer



There are various methods for printing with this printer.

The following describes the procedure for printing from a computer using P-touch Editor or P-touch Address Book.

- 1 Start P-touch Editor or P-touch Address Book, and then open the document you want to print.
- 2 Create a label design.
- 3 Check the cutting options.
- 4 Select **File > Print** or click the **Print** icon.

Cutting Options

The cutting options allow you to specify how the item is fed and cut when it is printed. Use the printer driver to select the cutting option when printing from the computer.

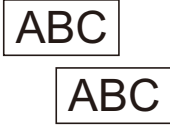
Auto Cut	Cut at End	Image
No	Yes	
No	No	
Yes	Yes or No	

Attach Labels

- 1 Peel the backing from the label.
- 2 Position the label, and then press firmly from top to bottom with your finger to attach the label.



Note

Labels may be difficult to attach to surfaces that are wet, dirty, or uneven. The labels may peel off easily from these surfaces.

Install the Printer Driver and Software on a Computer not connected to the Internet

- 1 On a computer connected to the Internet, visit support.brother.com, select your model, and open the **Downloads** page.
- 2 Select the operating system of the computer not connected to the Internet.
- 3 Download the files you need.

IMPORTANT

You must download at least the Printer Driver and P-touch Editor to the computer to use the printer.

Windows

- Do not use the **Software/Document Installer** as it needs an active Internet connection.
- Download each type of software individually, for example: the **Printer Driver** or **P-touch Editor**.

Mac

Download the **Full Software Package**.

- 4 Copy the downloaded EXE file (for Windows) or DMG file (for Mac) from the Downloads folder onto removable media (for example, a USB flash drive or CD-ROM).
- 5 Copy the downloaded files from the removable media onto the computer not connected to the Internet.
- 6 Double-click the downloaded files, and follow the on-screen instructions to proceed with the installation.
- 7 Close the dialog box when the installation is complete.



Application

How to Use P-touch Editor	13
How to Use P-touch Editor Lite (Windows only)	19
How to Use the P-touch Address Book (Windows only)	23
How to Use P-touch Library (Windows only)	28
How to Update P-touch Software	34

To use your label printer with your computer, install P-touch Editor and the printer driver.

For the latest drivers and software, visit support.brother.com and go to your model's **Downloads** page.

For Windows

Starting P-touch Editor

1 Start the P-touch Editor .

■ **For Windows 7:**

Click **Start > All Programs > Brother P-touch > P-touch Editor 5.2**, or double-click the **P-touch Editor 5.2** shortcut icon on the desktop.

■ **For Windows 8/ Windows 8.1:**

Click **P-touch Editor 5.2** on the **Apps** screen or double-click the **P-touch Editor 5.2** icon on the desktop.

■ **For Windows 10:**

Click **Start > P-touch Editor 5.2** under **Brother P-touch**, or double-click the **P-touch Editor 5.2** icon on the desktop.

2 When P-touch Editor starts, select whether you want to create a new layout or open an existing layout.



Note

To change how P-touch Editor functions when it starts, click **Tools > Options** in the P-touch Editor menu bar to display the **Options** dialog box. On the left side, select the **General** heading, and then the setting you want in the **Operations** list box under **Startup Settings**. The factory setting is **Display New View**.

3 Select one of the displayed options:

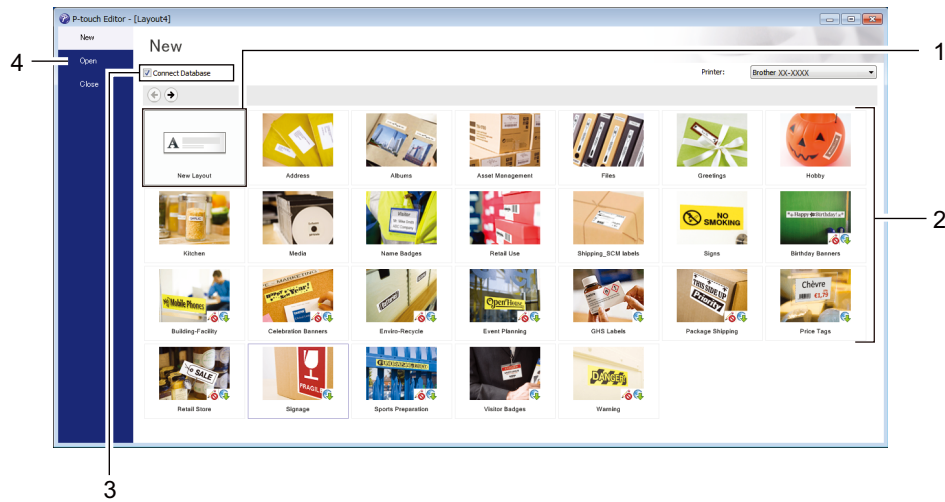

- 1 To create a new layout, double-click **New Layout**, or click **New Layout** and then click → .
- 2 To create a new layout using a preset layout, double-click a category button, or select a category button and then click →.
- 3 To connect a preset layout to a database, select the check box next to **Connect Database**.
- 4 To open an existing layout, click **Open**.

Printing with P-touch Editor

■ Express mode

This mode allows you to quickly create layouts that include text and images.

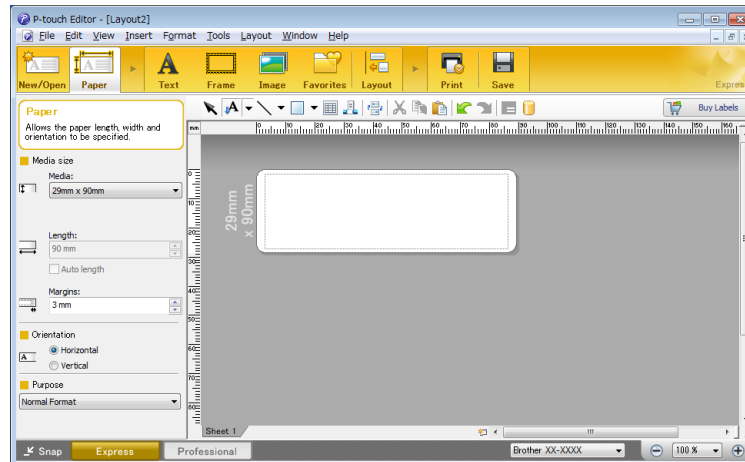

Configure the Printing Settings in the Print screen before printing.
To print, click **File** > **Print** from the menu bar or click the Print icon.

■ Professional mode

This mode allows you to create layouts using a wide-range of advanced tools and options.

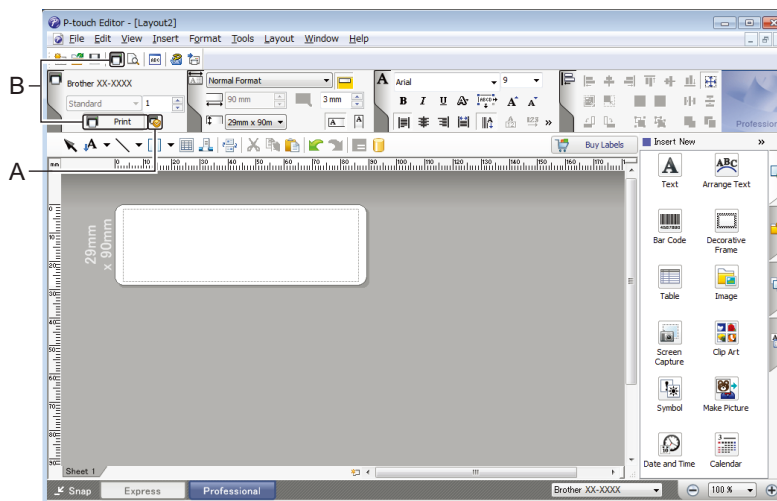

Configure the Printing Settings in the Print screen before printing.
To print, click **File** > **Print** from the menu bar or click the Print icon (A).

In addition, click the **Print** icon (B) to start printing without changing the printing settings.

■ Snap mode

This mode allows you to capture all or a portion of your computer screen display, print it as an image, and save it for future use.

- 1 Click the **Snap** mode selection button.
The **Description of Snap mode** dialog box appears.

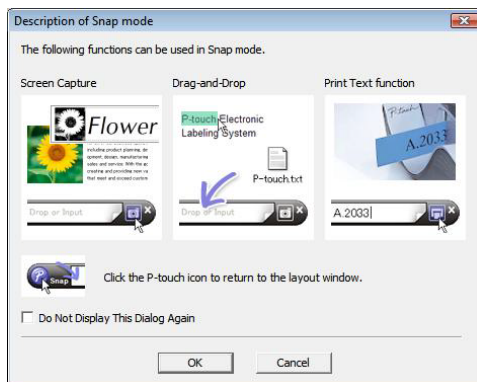

- 2 Click **OK**.
The **Snap** mode palette appears.

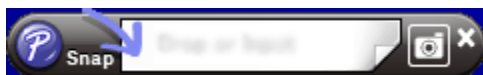

For Mac

Start P-touch Editor

Double-click **Macintosh HD > Applications**, and then double-click the **P-touch Editor** application

icon. 



Note

When using a Mac, you cannot transfer label data created using P-touch Editor to the printer.

When P-touch Editor starts, select whether you want to create a new layout or open an existing layout.

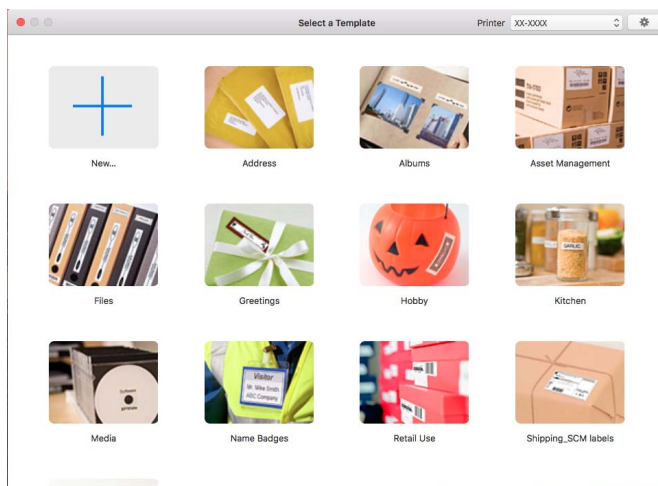

Operation modes

■ Standard mode

This mode allows you to create labels with text and images.

The Standard mode consists of the following sections:

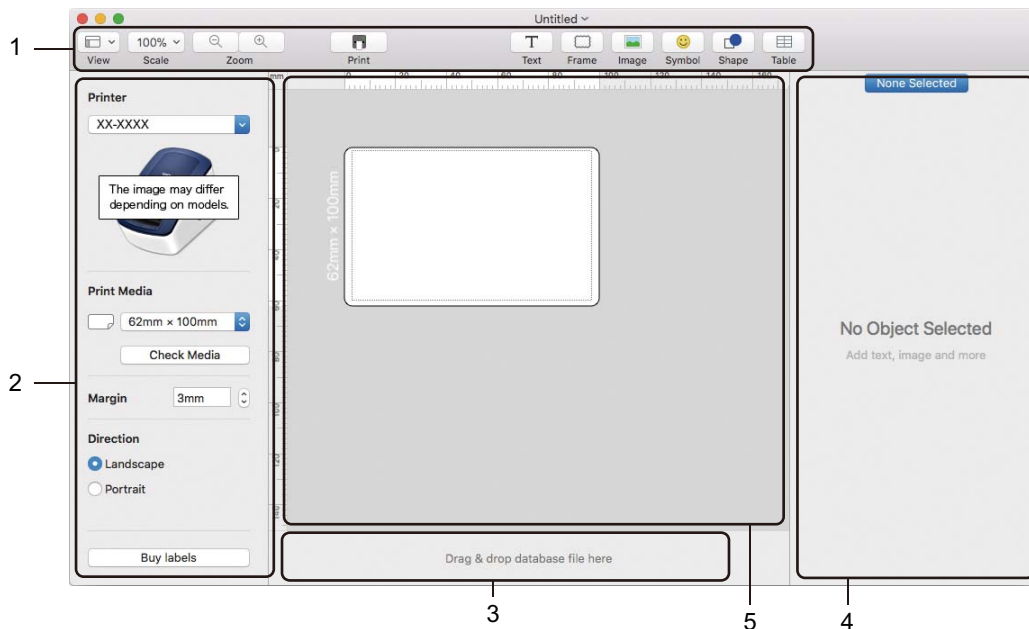

- 1 Toolbar
- 2 Label Inspector
- 3 Database Connection Area
- 4 Object Inspector
- 5 Layout Window

4

How to Use P-touch Editor Lite (Windows only)

With P-touch Editor Lite, you can quickly create various simple label layouts without installing any drivers or software.





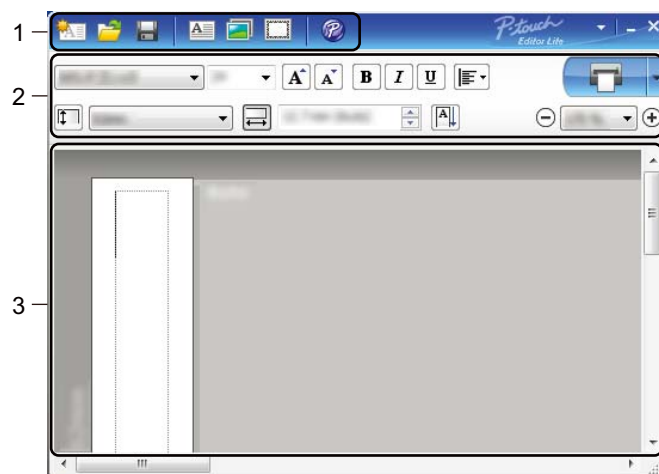





- 1 Turn the printer On.
- 2 Press and hold the P-touch Editor Lite Button until the green LED above it is lit.
- 3 Connect the USB Cable to your computer. After the USB Cable has been connected, a dialog box appears on your computer screen. The screens may differ depending on your operating system.
- 4 Start P-touch Editor Lite by double-clicking  PtLite10.

Layout Window





























- 1 Command Toolbar
- 2 Properties Toolbar
- 3 Label View

1 Command Toolbar

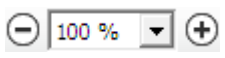





Icon	Function
	Displays the new label creation screen.
	Opens a saved file with P-touch Editor Lite.
	Saves the data to your computer, but not to the printer.
	Inserts a new text box (useful when creating labels containing both single and multiple lines of text).
	Inserts an image into your label. From file: Inserts an image stored on your computer. Screen capture: Inserts the selected area of the computer screen as a graphic. Symbol: Inserts one of your computer's built-in symbols.
	Inserts a frame.
	Opens the label in P-touch Editor instead of P-touch Editor Lite. The printer driver and P-touch Editor must be already installed.
	Displays the menu. The menu includes all P-touch Editor Lite functions.
	Minimises P-touch Editor Lite.
	Exits P-touch Editor Lite.

2 Properties Toolbar

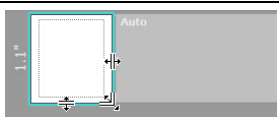
Icon	Function
	Click  to change the font.
	Click  to specify the font size. You can adjust the font size up or down one level by clicking  or  .
	Specifies the font style:    /      Underline
	Specifies the alignment of text in a text box.
	Sets the width of the label. Click  to automatically detect the width of the inserted label.
	Sets the length of the label. Click  to automatically adjust the length of the label to accommodate the entered text.

Icon	Function
	Changes the label direction to vertical.
	Click  to set the zoom factor for the Label View. You can also change the zoom factor by clicking  or  .
	Click  to print normally or  to print with options. Auto Cut: Each label is automatically cut after printing. Cut at end: Cuts labels after the last label is printed. Copies: Prints multiple copies of a label.

3 Label View

Display	Function
	This label view is displayed when the software is started. The label width currently set is displayed on the left of the label image. When "Auto" is shown on the right, the label length is automatically adjusted to the text length.
	To manually change the label length and width, move the pointer to the label area's border, and then drag it when the blue line appears.
	To adjust the size of the P-touch Editor Lite window, move the pointer over an edge of the window and drag it when the pointer changes to an arrow.
	Guidelines are sometimes displayed when moving objects. They are shown when the object is aligned at the left, right, top, or bottom edge of the Printable area, or in the centre. In the illustration on the left, the guidelines indicate that the object is centred at the top edge of the label.
	Inserted text boxes, images, and frames are treated as objects. Objects are surrounded by handles (indicated by eight blue points).
	Indicates that an object is selected.
	The pointer changes to an arrow when moved over a handle. Drag the handles to change the object's size.
	To move objects, drag them when the pointer changes to a crosshair. For text objects, the pointer only changes to a crosshair over the border of the object.

Right-click in the layout view area to select and execute the following menu items.

Other Functions (right-click to view)

Menu	Do this
Undo Redo	Click Undo to undo the last operation. Click Redo to redo the last operation.
Cut Copy Paste	Select the text area (or object) that you want to cut or copy and select Cut or Copy . Click in the destination area and select Paste .
Margins	The function is not available for this model.
Insert	Click Insert , and do one of the following: <ul style="list-style-type: none"> • Select Text box to insert text into the label. • Select From File to insert an image stored on your computer. • Select Screen Capture to select and insert an area of the computer screen. • Select Symbol to insert one of your computer's built-in symbols. • Select Frame to insert one of P-touch Editor Lite's built-in frames.
Direction	Select the text object and click either Horizontal Text or Vertical Text to change the direction of the text.
Numbering	Select the number or letter within your text and click Numbering to insert an incremented number or letter on each label. Click  to the right of the Print button and click Print Options . Select the Numbering box and enter the number of labels for printing in the Count field. Click the Print button.
Change Image	Select the image and click Change Image to replace the current image with a different image.
Rotate	Rotate objects to 0° , 90° , 180° or 270° .
Order	Select one of the objects and click Order , then select Bring to Front , Send to Back , Bring Forward , or Send Backward to set the order of each object in the layer.
P-touch Editor...	Open the label in P-touch Editor instead of P-touch Editor Lite. The printer driver and P-touch Editor must be already installed.
Options	Click Options . Select either millimeters (mm) or inches (in) to set the measurement unit setting. Select the P-touch Editor Lite language. Restart the application to apply the new selected " Language ". Select either Display New Value after Printing or Reset to Original Value after Printing to set the numbering option.
Brother Solutions Center	Click Brother Solutions Center to go to the website for assistance and information.
About...	Click About to learn about the P-touch Editor Lite version.
Exit	Click Exit to exit P-touch Editor Lite.

How to Use the P-touch Address Book (Windows only)

This section describes how to efficiently create labels from contacts using the P-touch Address Book. The screens may differ depending on your operating system.

(P-touch Address Book is not supported in some languages.)

Start the P-touch Address Book

- 1 Start the P-touch Address Book .

- **For Windows 7:**

Click **Start > All Programs > Brother P-touch > P-touch Address Book 1.3**, or double-click the **P-touch Address Book 1.3** shortcut icon on the desktop.

- **For Windows 8/ Windows 8.1:**

Click **P-touch Address Book 1.3** on the Apps screen or double-click the **P-touch Address Book 1.3** icon on the desktop.

- **For Windows 10:**

Click **Start > P-touch Address Book 1.3** under **Brother P-touch**, or double-click the **P-touch Address Book 1.3** icon on the desktop.

- 2 When the P-touch Address Book is launched, the **Startup** dialog box appears, which allows you to create new contacts, or import Outlook contacts and CSV formatted data.

- 3 In the **Startup** dialog box, specify the P-touch Address Book operation you want to perform and click the **OK** button.

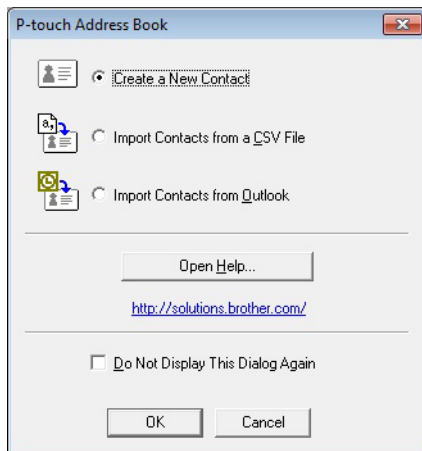

- When **Create a New Contact** is selected, the **New Contact** dialog box appears.
- When **Import Contacts from a CSV File** or **Import Contacts from Outlook** is selected, you can import contacts in other formats.
- Click the **Open Help...** button to open the P-touch Address Book Help files. The P-touch Address Book Help offers detailed information on available features and explains how to use the P-touch Address Book.

■ Layout Window

The Layout Window consists of the following sections:

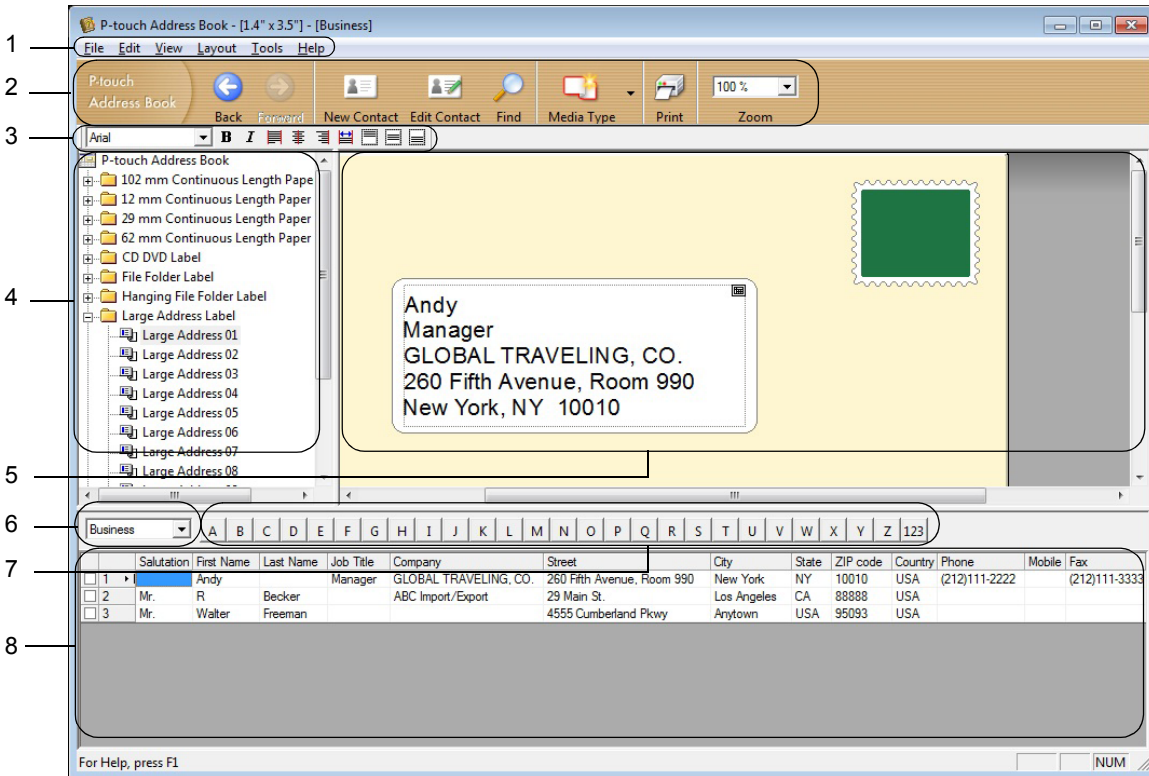

1 Menu Bar

Commands are categorised under each menu (File, Edit, View, Layout and Tools) according to their functions.

2 Standard Toolbar

Provides a group of frequently used commands (such as New Contact, Edit Contact, Find or Print).

3 Text Toolbar

Used to adjust text attributes such as font size and alignment for text formatting.

4 Layout Style Selection View

Displays layout styles stored in the folder.

5 Layout Work Area

Used to display or edit a layout that uses the layout style in the Layout Style Selection view.

6 Contact List Combo Box

Displays the contact list that is currently specified. You can choose from **Personal**, **Business**, **Other1**, **Other2** and **Other3**.

7 Index Tab

You can search within the field in Record View. Click **Tools > Sort** to open the **Sort** dialog box, and specify the field you want using **Key1**.

8 Record View

Displays the contact data in each field. The data can also be edited (added, deleted, or modified).

Create a New Contact

This section explains how to create a new contact.

- 1 Click **File > New Contact**, or click the **New Contact**  button.

The **New Contact** dialog box appears.

- 2 Enter the new contact information.

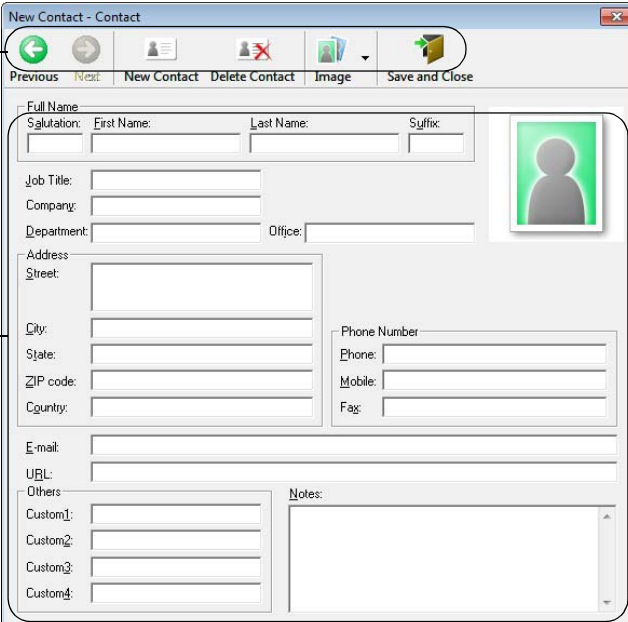





1

2

1 New Contact Form Toolbar

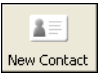
The following commands are categorised in the menu:

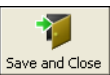
Icon	Button Name	Function
	Previous	Displays the previous contact.
	Next	Displays the next contact.
	New Contact	Displays the form window for a new contact.
	Delete Contact	Deletes the contact that is currently selected.
	Image	Allows you to insert an image for a contact from a file or a camera currently connected to the computer. The following file types are supported: <ul style="list-style-type: none"> • Bitmap (*.bmp, *.dib) • JPEG file (*.jpg, *.jpeg) • TIFF file (uncompressed) (*.tif) • GIF file (*.gif) • Icon (*.ico) • Windows Meta File (*.wmf, *.emf) (Image adjustment is not allowed.) • PNG file (*.png)
	Save and Close	Saves the contact and closes the New Contact dialog box.

2 Contact Form

Used to enter each item, such as name, address, phone number, company information, and email address for the new contact.

- 3 When you finish entering the data, click the **Save and Close**  button to store.

6

How to Use P-touch Library (Windows only)

This program allows you to manage and print P-touch Editor templates.

Start P-touch Library

■ For Windows 7:

Click **Start > All Programs > Brother P-touch > P-touch Tools > P-touch Library 2.3**.

■ For Windows 8 / Windows 8.1:

On the **Apps** screen, click **P-touch Library 2.3**.

■ For Windows 10:

Click **Start > P-touch Library 2.3** under **Brother P-touch**.

When P-touch Library starts, the Main window appears.

Main window

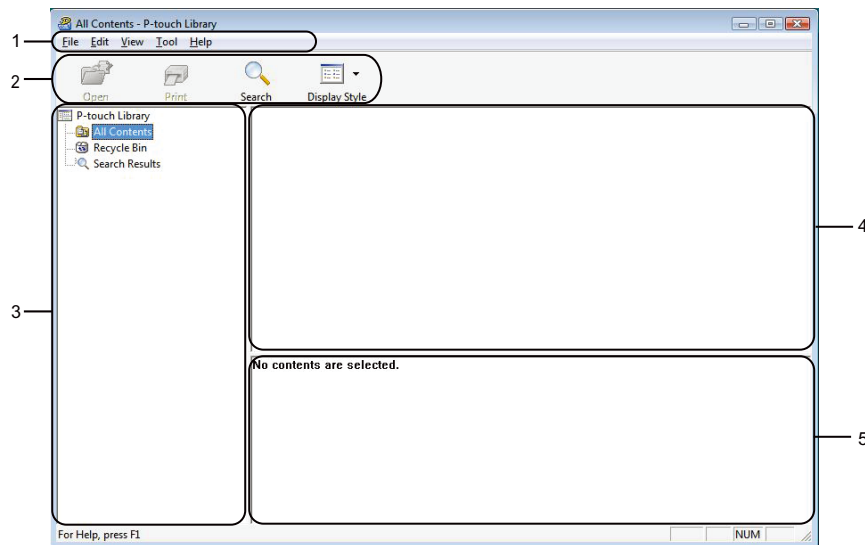

1 Menu Bar

Provides access to all available commands, which are grouped under each menu title (**File**, **Edit**, **View**, **Tool**, and **Help**) according to their functions.

2 Toolbar

Provides access to frequently used commands.

3 Folder List

Displays a list of folders. When you select a folder, the templates in the selected folder appear in the templates list.





4 Templates List

Displays a list of the templates in the selected folder.

5 Preview

Displays a preview of the templates selected in the templates list.

Explanations of the Toolbar Icons

Icon	Button name	Function
	Open	Opens the selected template.
	Print	Prints the selected template with the printer.
	Search	Allows you to search for templates registered to P-touch Library.
	Display Style	Changes the file display style.

Open and Edit Templates

Select the template you want to open or edit, and then click **Open**.

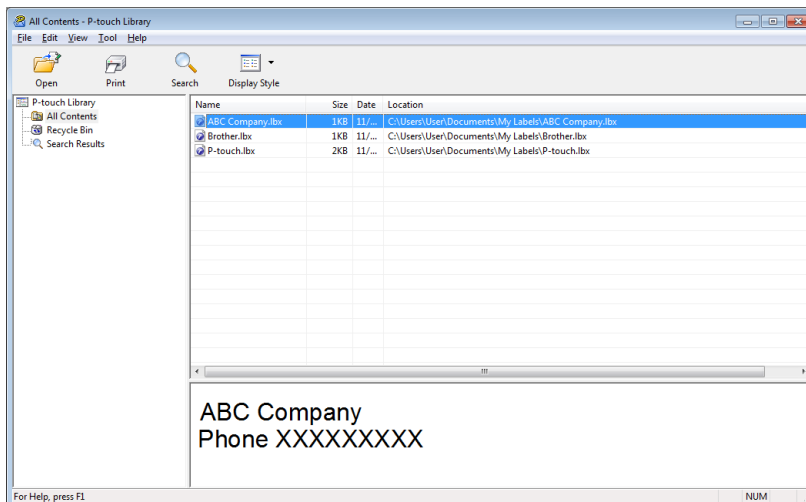

The program associated with the template launches, allowing you to edit the template.

Print Templates

Select the template you want to print, and then click **Print**.

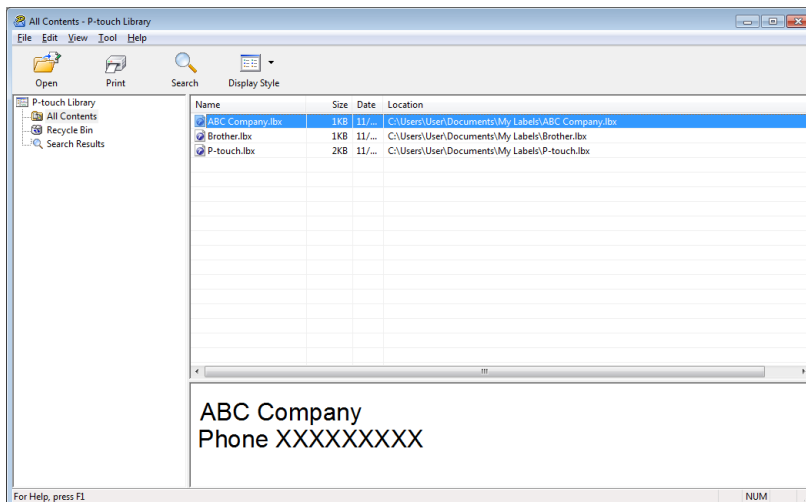

The connected printer prints the template.

Search for Templates

You can search for templates registered to P-touch Library.

- 1 Click **Search**.
The **Search** dialog box appears.

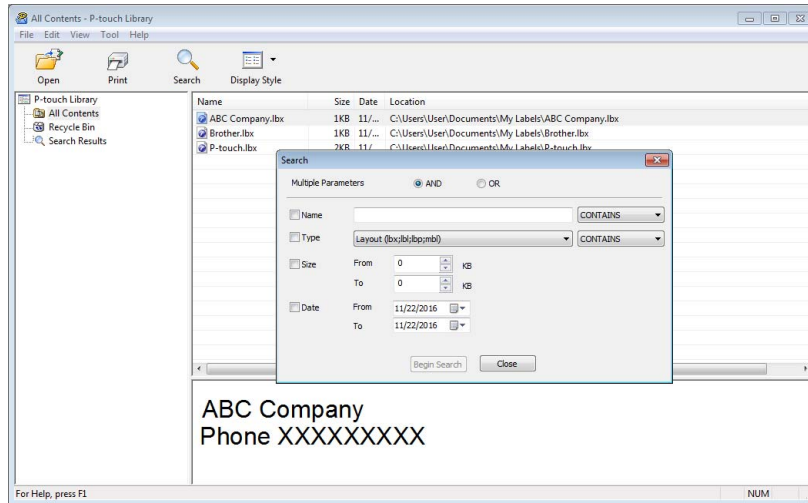

- 2 Specify the search criteria.
The following search criteria are available:

Settings	Details
Multiple Parameters	Determines how the program searches when multiple criteria are specified. If you select AND , the program searches for files that satisfy all of the criteria. If you select OR , the program searches for files that satisfy any of the criteria.
Name	Search for a template by specifying the file name.
Type	Search for a template by specifying the file type.
Size	Search for a template by specifying the file size.
Date	Search for a template by specifying the file date.

- 3 Click **Begin Search**.
The search begins and the search results are displayed.

- 4 Close the **Search** dialog box.
To confirm the search results, click **Search Results** in the folder view.



Note

You can register templates to P-touch Library by dragging and dropping them into the **All Contents** folder or to the folder list. You can also configure P-touch Editor to register templates to P-touch Library automatically, using the following procedure:

- 1 From the P-touch Editor menu, select **Tools > Options**.
- 2 In the **Options** dialog box, click **General > Registration Settings**.
- 3 Select the timing for registering templates created with P-touch Editor, and then click **OK**.

7

How to Update P-touch Software

The software can be upgraded to the latest available version using the P-touch Update Software.



Note

- The actual software and the contents of this manual may differ.
- Do not turn off the power when transferring data or updating firmware.

Update P-touch Editor and P-touch Address Book (Windows only)

IMPORTANT

Before updating P-touch Editor and P-touch Address Book, install the printer driver.



1 Start the P-touch Update Software.

■ For Windows 7:

Double-click the **P-touch Update Software** icon.



Note

The following method can also be used to start P-touch Update Software:

Click **Start > All Programs > Brother P-touch > P-touch Update Software**.

■ For Windows 8 / Windows 8.1:

Click **P-touch Update Software** on the **Apps** screen or double-click **P-touch Update Software** on the desktop.

■ For Windows 10:

Click **Start > Brother P-touch > P-touch Update Software**, or double-click **P-touch Update Software** on the desktop.



- 2 Click the **Computer software update** icon.

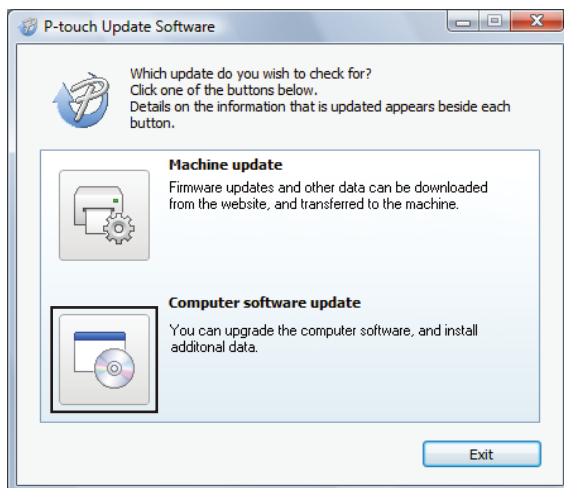

- 3 Select the **Printer** and **Language**, select the check boxes next to P-touch Editor and P-touch Address Book, and then click **Install**.

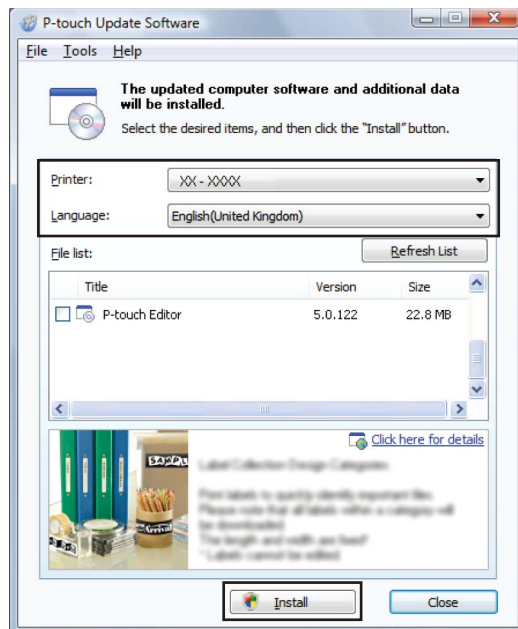

- 4 A message appears indicating that the installation has finished.

Update the Firmware

IMPORTANT

- Before updating the firmware you must install the printer driver.
 - Do not turn off the power when transferring data or updating firmware.
 - If another application is running, exit the application.
 - If the Editor Lite LED is lit in green, press and hold the Editor Lite Button until the LED is off.
-

For Windows

1 Turn the printer On and connect the USB cable.

2 Start the P-touch Update Software.

■ **For Windows 7:**

Double-click the **P-touch Update Software** icon.



Note

The following method can also be used to start P-touch Update Software:

Click **Start > All Programs > Brother P-touch > P-touch Update Software**.

■ **For Windows 8 / Windows 8.1:**

Click **P-touch Update Software** on the **Apps** screen or double-click **P-touch Update Software** on the desktop.

■ **For Windows 10:**

Click **Start > Brother P-touch > P-touch Update Software**, or double-click **P-touch Update Software** on the desktop.



- 3 Click the **Machine update** icon.

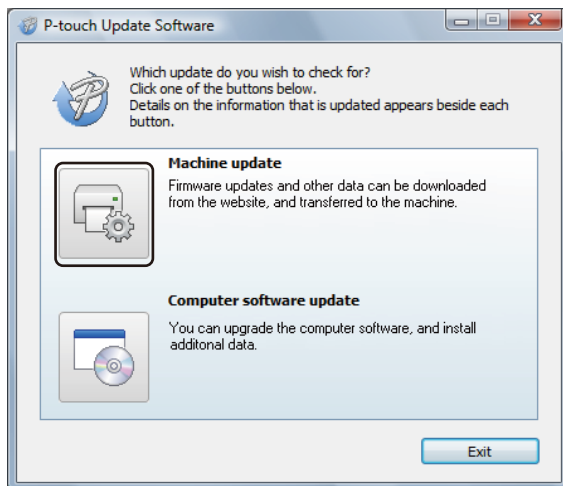

- 4 Select the **Printer**, make sure that **The machine is connected correctly.** message appears, and then click **OK**.

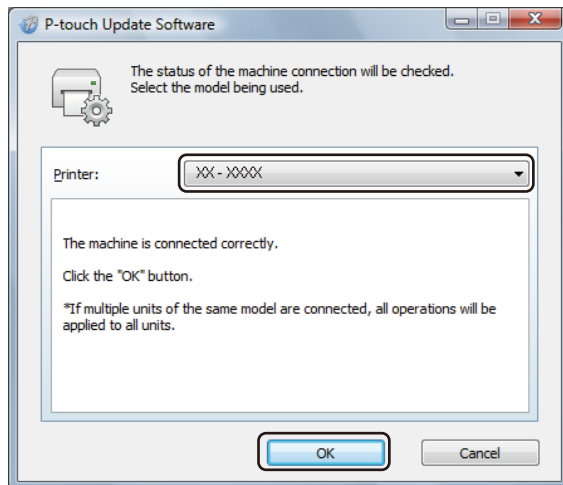

- 5 Select the **Language**, select the check box next to the firmware you want to update to, and then click **Transfer**.

IMPORTANT

Do not turn the printer off or disconnect the cable during data transfer.

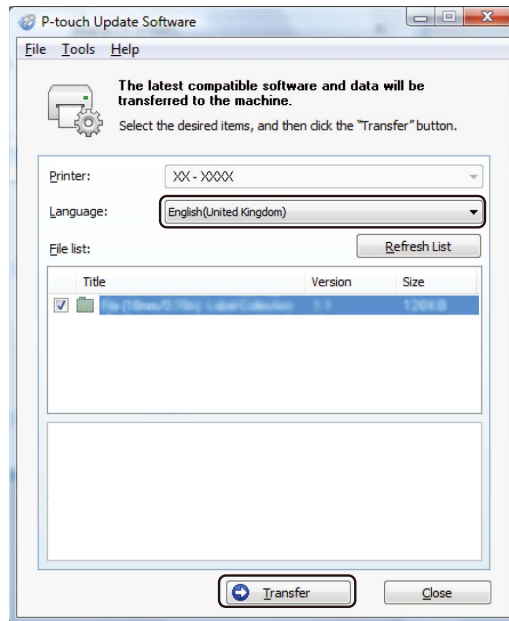

- 6 Check the content to be updated, and then click **Start** to begin the update. The firmware update begins.

IMPORTANT

Do not turn the printer off or disconnect the cable during the update process.

For Mac

- 1 Turn the printer On and connect the USB cable.
- 2 Double-click **Macintosh HD > Applications > P-touch Update Software**, and then double-click the **P-touch Update Software** application icon.



- 3 Click the **Machine update** icon.

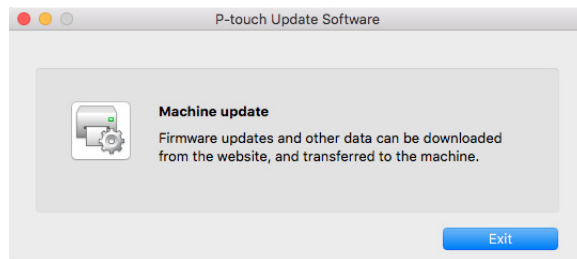

- 4 Select the **Printer**, make sure that **The machine is connected correctly.** message appears, and then click **OK**.
- 5 Select the **Language**, select the check box next to the firmware you want to update to, and then click **Transfer**.

IMPORTANT

Do not turn the printer off or disconnect the cable during data transfer.

- 6 Check the content you want to update, and then click **Start** to begin the update. The firmware update begins.



Note

Do not turn the printer off during the update process.



Appendix

Reset the Label Printer	41
Maintenance	42
Troubleshooting	43
Product Specifications	50
Printing directly from other Windows software	51

Reset your printer's device settings if the printer is not operating correctly.

Reset Device Settings to the Factory Settings Using the Label Printer Buttons

To reset the printer, do the following:

- 1 Turn the printer off.
- 2 Press and hold the Power (⏻) and Cutter (✂) Buttons for about two seconds. The Status LED lights in orange and the Editor Lite LED flashes in green.
- 3 Continue holding down the Power (⏻) Button, and press the Cutter (✂) Button six times.
- 4 Release the Power (⏻) Button. The Status LED flashes in orange and the Editor Lite LED flashes in green. Then, the Status LED lights in green.

We recommend cleaning your printer on a regular basis to maintain its correct performance.

**Note**

Always disconnect the AC Power Cord before cleaning the printer.

Clean the Exterior of the Unit

Wipe any dust and marks from the main unit using a soft, dry cloth.

Use a cloth slightly damp with water on difficult to remove marks.

**Note**

Do not use paint thinner, benzene, alcohol or any other organic solvent.

These may deform or damage the printer case.

Clean the Label Outlet

If a label causes the machine to jam due to adhesive residue attached to the label outlet, disconnect the AC Power Cord from the machine and clean it with a cloth or cotton swab dipped in isopropyl alcohol or ethanol.

**Note**

Use isopropyl alcohol or ethanol according to the manufacturer's safety guidelines, as applicable.

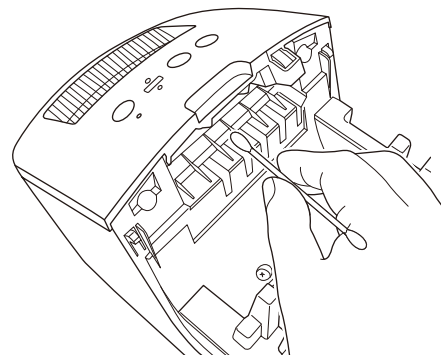
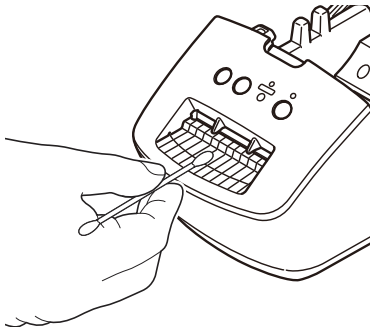

Self-Cleaning Print Head

The DK Roll (thermal recording paper type) used with the machine is designed to clean the print head automatically. When the DK Roll passes the print head during printing and label feeding, the print head is cleaned.

Overview

This chapter explains how to resolve typical problems you may encounter when using the label printer. If you have any problems with the printer, first make sure you have performed the following tasks correctly:

- Connect the printer to an electrical socket. For more information, see *Connect the Power Cord* on page 4.
- Remove all protective packaging from the printer.
- Install and select the correct printer driver. For more information, see *Install the Printer Driver and Software on a Computer* on page 8.
- Connect the printer to a computer. For more information, see *Connect the Label Printer to a Computer* on page 8.
- Close the DK Roll Compartment Cover completely.
- Insert a DK Roll correctly. For more information, see *Load the DK Roll* on page 5.









If you still have problems, read the troubleshooting tips in this chapter for help. If, after reading this chapter, you are unable to resolve your problem, visit the Brother support website at support.brother.com.















Driver Installation Problems (for Windows)







Problem	Solution
The "Device driver software was not successfully installed." message appears on the computer.	<ul style="list-style-type: none"> • Although such Windows messages may continue to appear during the installation, you can still install the driver correctly using the installer. • Before you run the installer, make sure that the printer is on and that it is connected to your computer with a USB cable. • If the printer driver is not successfully installed, go to <i>I cannot install the printer driver even if I follow the correct procedure.</i> on page 43.
<ul style="list-style-type: none"> • I cannot install the printer driver even if I follow the correct procedure. • I cannot see my printer listed in P-touch Editor even though I have installed the printer driver. 	<p>If you cannot use your printer even though you have installed the printer driver:</p> <ol style="list-style-type: none"> 1 Download the Printer Driver Uninstaller from support.brother.com. 2 Use the Printer Driver Uninstaller to remove the printer information. 3 Run the installer again and follow the on-screen instructions to proceed with the installation.

LED Indications

The indicators light and flash to indicate the printer's status.

-  or  or  Indicator is lit in the colour shown
-  or  or  Indicator is flashing in the colour shown
-  Indicator can be off, lit, or flashing in any colour
-  Indicator is off

Status LED	Editor Lite LED	Condition
		Power is Off
		Idle mode
		Feeding mode
		Printing mode
		Cutting mode
		P-touch Editor Lite mode
		Receiving data
		Cancelling the print job
		The DK Roll Compartment Cover is open. Close the DK Roll Compartment Cover correctly.
		The printer is in Reset mode. For more information, see <i>Reset Device Settings to the Factory Settings Using the Label Printer Buttons</i> on page 41.
		The printer is in Cooling mode.
		The printer settings are being reset. For more information, see <i>Reset Device Settings to the Factory Settings Using the Label Printer Buttons</i> on page 41.
		The printer is in Boot mode. Try updating the firmware. For more information, see <i>Update the Firmware</i> on page 36. If the printer is still in Boot mode, contact Brother customer service.

Status LED	Editor Lite LED	Condition
 <p>(Once for 2 seconds)</p>		Roll end error
		No media error
		Wrong media error
		Feed error
		Cover open error
		Transferred data error
 <p>(Twice for 2 seconds)</p>		Cutter error
 <p>(Flashes rapidly)</p>		System error Contact Brother customer service.

Printing Problems

Problem	Solution
The Status LED is not lit.	Is the AC Power Cord inserted correctly? Check that the AC Power Cord is inserted. If it is inserted correctly, try plugging it into another electrical socket.
The printer does not print, or a printing error is received.	<ul style="list-style-type: none"> • Is the cable loose? Check that the cable is connected securely. • Is the DK Roll installed correctly? If not, remove the DK Roll and reinstall it. • Is there enough roll remaining? Check that there is enough roll remaining. • Is the DK Roll Compartment Cover open? Check that the DK Roll Compartment Cover is closed. • Has a print error or transmission error occurred? Turn the printer Off and then turn it On again. If there is still a problem, contact your Brother customer service. • If the printer is connected via a USB hub, try connecting it directly to the computer. If not, try connecting it to another USB port.
The printed label contains streaks or poor quality characters, or the label is not fed correctly.	Is the print head or roller dirty? While the print head generally remains clean under normal use, lint or dirt from the roller may become stuck on the printer head. If this occurs, clean the roller. For more information, see <i>Self-Cleaning Print Head</i> on page 42.
A data transmission error appears on the computer.	Is the printer in cooling mode (the Status LED is flashing in orange)? Wait until the Status LED stops flashing and then try printing again.
Labels are jammed in the cutter.	Contact Brother customer service.
The label is not ejected correctly after printing.	<ul style="list-style-type: none"> • Check that the Label Output Slot is not blocked. • Check that the DK Roll is set correctly by removing the DK Roll and reinstalling it. • Ensure that the DK Roll Compartment Cover is closed correctly.
I want to cancel the current printing job.	Make sure that the printer is On, and press the Power (⏻) Button.
The print quality is poor.	Is there dirt or lint on the roller preventing it from rolling freely? For more information, see <i>Self-Cleaning Print Head</i> on page 42.
After replacing the Roll while the Add-In feature was activated, the layout style was not updated.	Close P-touch Editor to exit the Add-In, and then reactivate the Add-In.
The P-touch Add-In icon is not displayed in Microsoft Word.	<ul style="list-style-type: none"> • Is Microsoft Word started up from Microsoft Outlook? • Is Microsoft Word chosen as the default editor for Microsoft Outlook? Due to program limitations, the Microsoft Word Add-In does not work with the above settings. Quit Microsoft Outlook, and restart Microsoft Word.

Problem	Solution
<p>The printer is in cooling mode</p>	<p>The thermal head is too hot.</p> <p>The printer stops and resumes printing only after the thermal head has cooled down. The head may become too hot if you are printing a large number of labels.</p> <p>When the thermal head becomes too hot, it may produce imaging outside the print area. To avoid or delay overheating, make sure the printer has adequate ventilation and is not located in an enclosed space.</p> <p>If the printer must cool down because it overheated due to the type of DK Roll you are using or the contents of the label, printing may take longer than usual.</p> <p> Note _____ This condition may occur more often when the printer is used at high altitude (more than 10,000 ft (3,048 m)) due to a lower air density available to cool the printer.</p>
<p>Cutter error</p>	<p>If a cutter error occurs, keep the DK Roll Compartment Cover closed and press the Power (⏻) Button. The cutter moves back to the normal position and the printer turns off automatically.</p> <p>After the printer is Off, check the label outlet and remove any jammed labels. Contact Brother customer service.</p>
<p>Unable to reset an error</p>	<p>To reset an error:</p> <ol style="list-style-type: none"> 1 Open the DK Roll Compartment Cover, and then close it. 2 If the error is not reset, press the Cutter (✂) Button or Feed (↓) Button. 3 If the error is not reset, turn the printer off, and then turn it on again. 4 If the error is not reset, contact Brother customer service.
<p>I want to reset the printer.</p>	<p>You can reset the printer using the Printer buttons.</p> <p>For more information, see <i>Reset Device Settings to the Factory Settings Using the Label Printer Buttons</i> on page 41.</p>

Problem	Solution
<p>Printed barcodes cannot be read.</p>	<ul style="list-style-type: none"> ■ Print labels so that barcodes are aligned with the print head as shown below: <div data-bbox="889 394 1209 552" style="text-align: center;"> <p>The diagram illustrates the correct alignment for printing barcodes. A horizontal grey bar at the top is labeled '1' and represents the print head. Below it, a rectangular box represents a label, labeled '3'. Inside the label box, a barcode is shown, labeled '2'. A downward-pointing arrow indicates the direction of the print head's movement over the barcode.</p> </div> <ul style="list-style-type: none"> 1 Print head 2 Barcodes 3 Printing orientation <ul style="list-style-type: none"> ■ Barcodes may not be read if they are reduced or enlarged. ■ Try using another scanner. ■ We recommend printing barcodes with Print Quality options set to Give priority to print quality. <p>For Windows 7: To display the Quality options, open the printer properties by clicking Start > Devices and Printers, right-clicking the printer you want to set up, and then clicking Printing preferences.</p> <p>For Windows 8 / Windows 8.1: To display the Quality options, open the printer properties by clicking Control Panel in the Apps screen > Hardware and Sound > Devices and Printers, right-clicking the printer you want to set up, and then clicking Printing preferences.</p> <p>For Windows 10: To display the Quality options, open the printer properties by clicking Start > Settings > Devices > Printers & scanners > Devices and Printers, right-clicking the printer you want to set up, and then clicking Printing preferences.</p> <p>For Mac: To change the Print Quality options, open the Print dialog box and select Basic from the print options pop-up menu.</p>

Version Information

Problem	Solution
I do not know the version number of the firmware for the printer.	To check for the latest firmware: <ol style="list-style-type: none"> 1 Turn your printer on. 2 Press and hold the Cutter (✂) Button for several seconds to print the report. We recommend you use a 62 mm DK Roll.
I want to confirm whether I am using the latest version of the software.	Use the P-touch Update Software to confirm whether you have the latest version. For more information about the P-touch Update Software, see <i>How to Update P-touch Software</i> on page 34.

Label Printer Specifications

Items	Specifications	
Display	Status LED (green, orange, red), Editor Lite LED (green)	
Print	Printing method	Direct thermal printing via thermal head
	Speed of printing	Max. 150 mm/sec, Max. 93 labels/min. (Standard Address Labels)(When connected to the PC and using P-touch Editor)
	Print head	300 dpi/720 dot
	Max. printing width	59 mm
	Max. printing length	1 m
	Min. printing length	12.7 mm
Cutter	Durable automatic cutter	
Buttons	Power (⏻) button, Feed (↓) button, Cutter (✂) button, Editor Lite Button	
Interface	USB	
Power supply	220 V - 240 V AC, 50/60 Hz, 1.1 A	
Size (W x D x H)	128 mm x 221 mm x 153 mm	
Weight	Approx. 1.1 kg (Without DK Rolls)	

Operating environment

Items	Specifications
Operating temperature	10°C to 35°C
Operating humidity	20% to 80% (without condensation)

You can use this machine to print directly from various Windows software, by installing the printer driver.

IMPORTANT

Because the paper size for this machine is different from other regular printers, you may not be able to print even after installing the driver and software, unless the software allows for the correct label size to be set.

Setting the Printer Driver

The printer names in the following screens may differ from your printer's name.

The screens may vary depending on the printer model, or your operating system.

- 1 Open the **Devices and Printers** window.
 - **For Windows 7:**
Click the **Start** menu > **Devices and Printers**.
 - **For Windows 8 / Windows 8.1:**
 - 1 On the desktop screen, move your cursor to the upper or lower right corner. The menu bar will appear on the right edge of the Desktop screen.



Note

If the Start screen is on your computer screen, click the desktop tile on the Start screen first.

- 2 Click **Settings > Control Panel > Hardware and Sound > Devices and Printers**.
 - **For Windows 10:**
 - 1 Click / right-click (For the touch operation, touch and hold) **Start** on the desktop.
 - 2 (**Windows System >**) **Control Panel > Hardware and Sound > Devices and Printers**.



Note

For details, see Windows Help.

- 2 Select "Brother QL-XXX" (where "XXX" is your printer name), and right click and select **Select printing preferences**. The **Brother QL-XXX printing preferences** dialog box appears.
- 3 Select the settings you want and click **OK**. You can set the paper size, number of copies, quality and cut option.

Basic Tab

You can set the paper size, number of copies, quality and cut option.

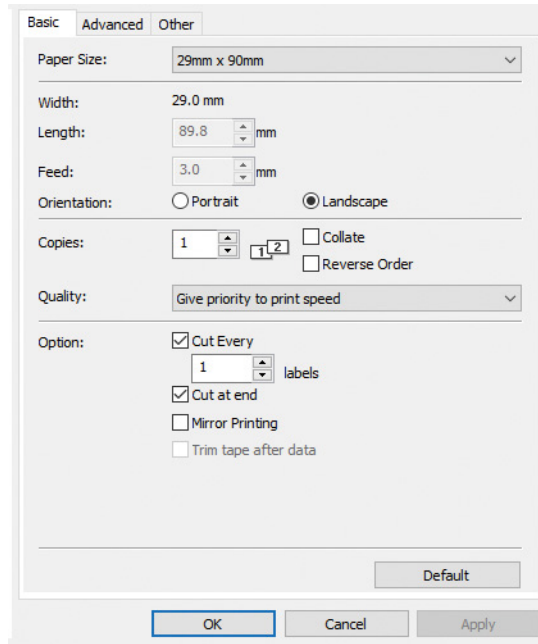

Advanced Tab

You can set graphics options ("Halftone", "Brightness" and "Contrast") and "Continuous Tape Format".

You can change the Label Format or create a new Label Format from the **Continuous Tape Format** dialog box, which appears when you click **Settings....**

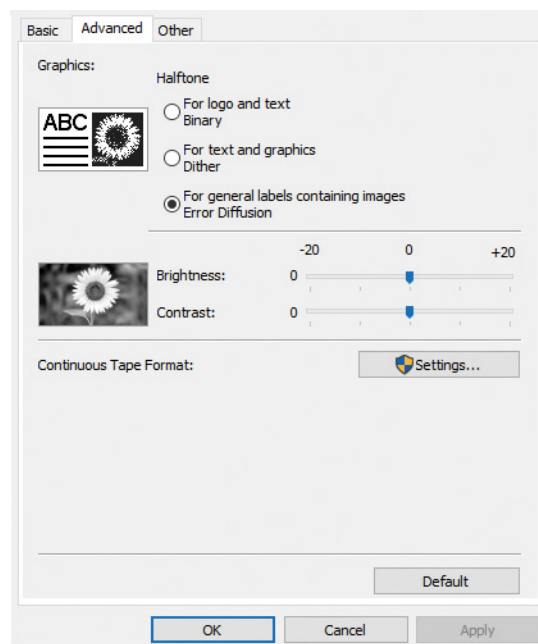

You can set the format name ("Name") and size ("Width", "Length", and "Feed"), and click **Default**.

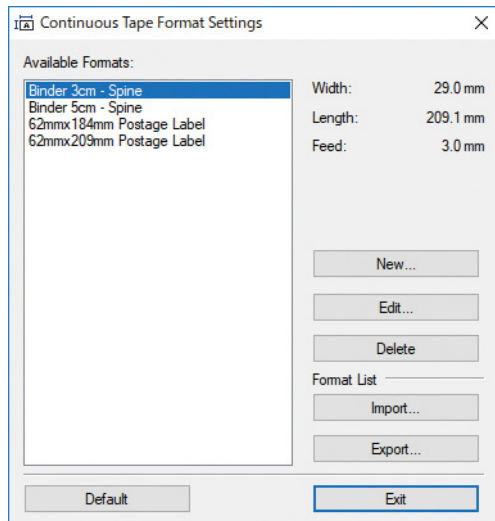

Other Tab

You can change the measurement unit ("mm" or "inch").

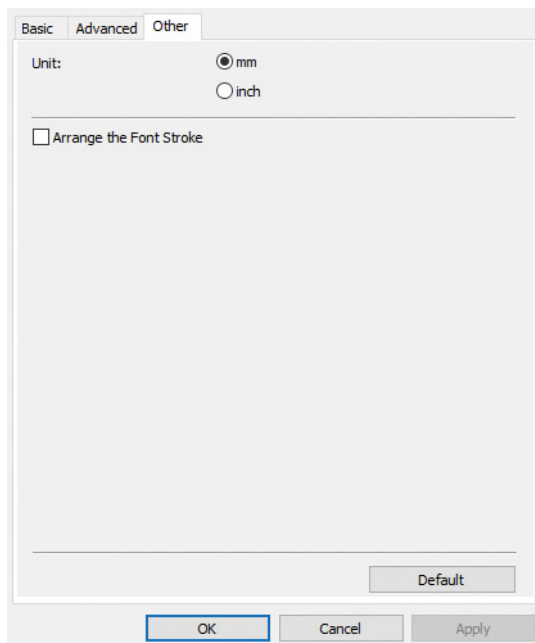

Printing from other Windows software

To print from other Windows software, you must follow the instructions below.

The operation methods may differ depending on the software.

IMPORTANT

Because the paper size for this machine is different from other regular printers, this printer may not achieve optimal results.

- 1 Select "Brother QL-XXX" (where "XXX" is your printer name) in the printer setting of the application.
- 2 Adjust the paper size setting to the size of DK Roll set in your printer.

brother