

Connector ProTOP - Part no. 125

- screw terminals
- cable gland and sealing
- strain relief and protection against kinking
- enclosure with thread lock and safety slide

Technical information

Ampere	32 A
Poles	4 p
Voltage	230V
Earth position	9 h
Hertz	50-60 Hz
Connection technology	Screw terminals
Contact	standard
Protection type	IP 44

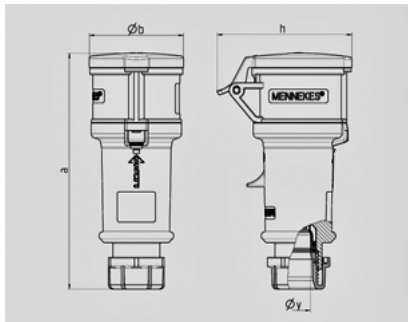

Drawing 3 MB 60	Amp. Poles	16			32		
		3	4	5	3	4	5
Dim. in mm	a	160	174	172	214	214	210
	b	57	61	69	75	75	80
	h	83	92	98	100	100	108
	y	16	16	16	22	22	22
Terminal for cond. cross		1	1	1	2,5	2,5	2,5
section (mm²) min.-max.		-2,5	-2,5	-2,5	-6	-6	-6