



Model Number

NBN40-U1-A2

Features

- Sensor head bidirectional and rotatable
- 40 mm non-flush
- 4-wire DC
- 4 LEDs indicator for 360° visibility

Accessories

V1-M20-80

Receptacles, M12/M20; plastic version

MHW 01

Modular mounting bracket

Technical Data

General specifications

Switching function		complementary
Output type		PNP
Rated operating distance	s_n	40 mm
Installation		non-flush
Output polarity		DC
Assured operating distance	s_a	0 ... 32.4 mm
Reduction factor r_{Al}		0.31
Reduction factor r_{Cu}		0.3
Reduction factor r_{304}		0.74
Reduction factor r_{Brass}		0.39
Output type		4-wire

Nominal ratings

Operating voltage	U_B	10 ... 30 V DC
Switching frequency	f	0 ... 180 Hz
Hysteresis	H	typ. 5 %
Reverse polarity protection		reverse polarity protected
Short-circuit protection		pulsing
Voltage drop	U_d	≤ 2 V
Design data		
Operating current	I_L	0 ... 200 mA
Off-state current	I_r	0 ... 0.5 mA
No-load supply current	I_0	≤ 20 mA
Time delay before availability	t_v	80 ms
Operating voltage indicator		LED, green
Switching state indicator		LED, yellow

Functional safety related parameters

MTTF _d	1230 a
Mission Time (T_M)	20 a
Diagnostic Coverage (DC)	0 %

Ambient conditions

Ambient temperature	-25 ... 85 °C (-13 ... 185 °F)
---------------------	--------------------------------

Mechanical specifications

Connection type	screw terminals
Information for connection	A maximum of two conductors with the same core cross section may be mounted on one terminal connection! tightening torque 1.2 Nm + 10 %
Core cross-section	up to 2.5 mm ²
Minimum core cross-section	without wire end ferrule 0.5 mm ² , with connector sleeves 0.34 mm ²
Maximum core cross-section	without wire end ferrule 2.5 mm ² , with connector sleeves 1.5 mm ²
Housing material	PA/metal with epoxy powder coating
Sensing face	PA
Housing base	plastic
Degree of protection	IP68 / IP69K
Mass	225 g
Note	Tightening torque: 1.8 Nm (housing)

Compliance with standards and directives

Standard conformity	
Standards	EN 60947-5-2:2007 EN 60947-5-2/A1:2012 IEC 60947-5-2:2007 IEC 60947-5-2 AMD 1:2012

Approvals and certificates

EAC conformity	TR CU 020/2011
UL approval	cULus Listed, General Purpose
CCC approval	CCC approval / marking not required for products rated ≤36 V

Dimensions

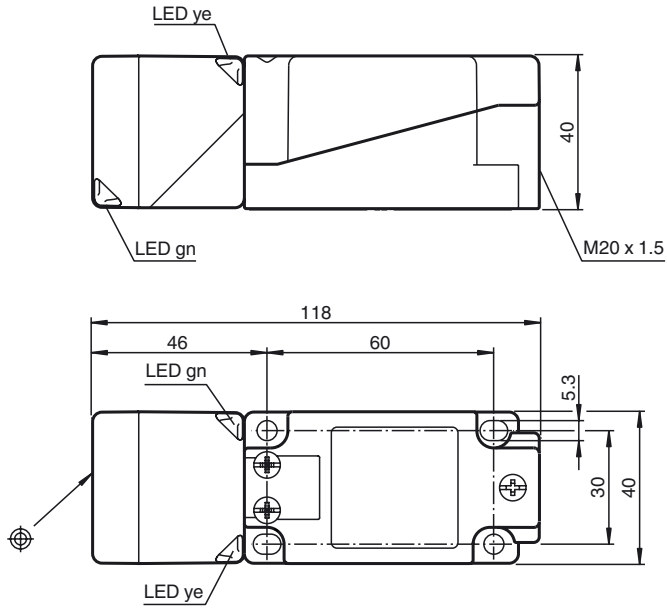

Electrical Connection

