

# PE8216/PE8324

## ECO PDU

- As part of its NRGence line, ATEN has developed a new generation of green energy power distribution units (eco PDUs) to effectively increase the efficiency of data center power usage. The NRGence PE8216 / PE8324 eco PDUs are intelligent PDUs that contain 16, or 24 AC outlets and are available in various IEC socket configurations. Models in the advanced PE8 ranges feature NRGence's proactive overload protection, which automatically powers off the last outlet that caused the current overload.

NRGence eco PDUs provide secure, centralized, intelligent, power management (power on, off, cycle) of data center IT equipment (servers, storage systems, KVM switches, network devices, serial data devices, etc.), as well as the ability to monitor the center's health environment via sensors



NRGence eco PDUs offer remote power control combined with real-time power measurement – allowing you to control and monitor the power status of devices attached to the PDUs, either at the PDU device, bank, or outlet level, depending on the model, from practically any location via a TCP/IP connection.

The power status of each outlet can be set individually, allowing users to switch each device On/Off. The eco PDU also offers comprehensive power analysis reports which can separate departments and locations, providing precise measurements of current, voltage, power and watt-hour in a real-time display. Installation and operation is fast and easy: plugging cables into their appropriate ports and user-friendly browser-based configuration and management is all that is entailed. Since the eco PDU firmware is upgradeable over the Net, you can stay current with the latest functionality improvements simply by downloading updates from our website as they become available.

NRGence eco PDU supports any 3rd party V3 SNMP Manager Software and NRGence eco Sensors (eco PDU Manager Software). eco Sensors provides you with an easy method for managing multiple devices, offering an intuitive and user-friendly Graphical User Interface that allows you to configure a PDU device and monitor power status of the equipment connected to it.

With its advanced security features and ease of operation, the eco PDU is the most convenient, most reliable, and most cost effective way to remotely manage power access for multiple computer installations and allocate power resources in the most efficient way possible.

# PE8216B ECO PDU

|                       |   |
|-----------------------|---|
| Description:          | 100-240V 20A 0U 16-Outlet PDU   |
| Function:             | 16-Outlet Metering,<br>16-Outlet Switching Control &<br>1-Bank Metering   |
| Input Power Plug:     | NEMA 6-20P   |
| Power Capacity:       | 4.2 kW  |
| Socket Configuration: | IEC 60320 C19 (2) <br>IEC 60320 C13 (14)  |

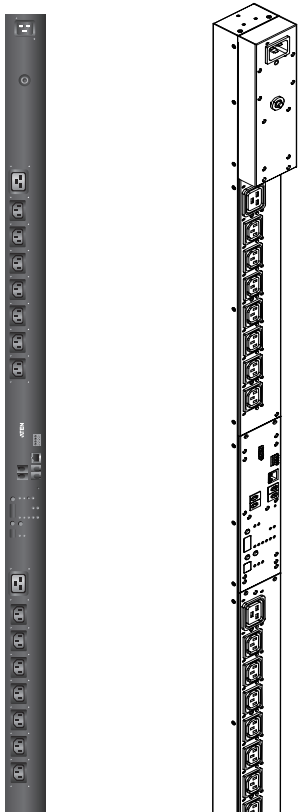

## Features

### Connections

- Supports 10/100Mbit Ethernet Interface
- Supports TCP/IP, UDP, HTTP, HTTPS, SSL, DHCP, ARP, NTP, DNS, Telnet, Auto Sense, Ping, SNMP V1,V2&V3
- Supports three-level account/password security, IP/MAC filter, 128 bit SSL, RADIUS
- Supports, eco Sensors, multiple Browsers (IE, Firefox, Chrome, Safari)

### Metering

- PDU and outlet level power metering and monitoring
- Environment monitoring – supports external temperature/temperature & humidity sensors for rack temperature and humidity monitoring
- Current, voltage, power, power dissipation, temperature, and humidity metering and threshold level setting
- Support door sensor

### Outlet Switch Control

- Remote power outlet control (On/Off, Power Cycle) by individual outlets and outlet groups
- Outlet group support at the PDU
- Supports multiple power control methods – Wake on LAN, System After AC Back, Kill the Power
- Power-On sequencing – users can set the power-on sequence and delay time for each outlet to allow equipment to be powered on in the correct order
- Proactive overload protection(POP) – automatically powers off the last outlet that caused the current overload *Patent Pending!*

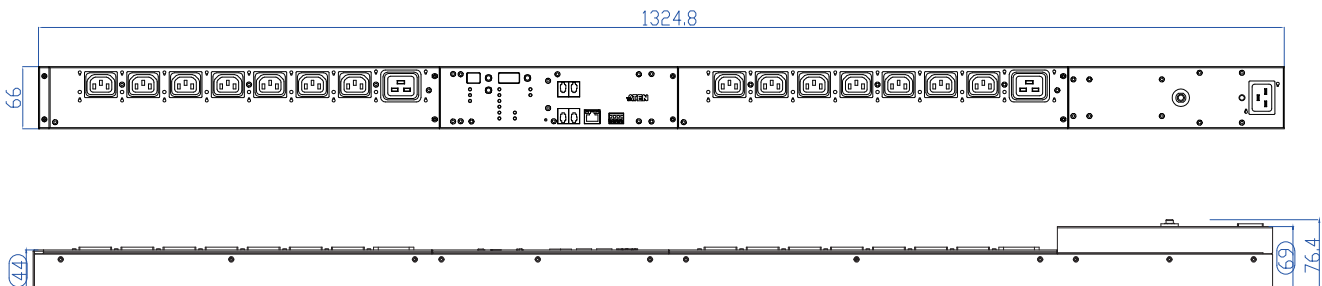

## Specifications

| Model                             | PE8216B   |
|-----------------------------------|---|
| <b>Electrical</b>                 |   |
| Nominal Input Voltage             | 100 – 240 VAC   |
| Maximum Input Current             | 20A Max ; 16A (UL de-rated)   |
| Input Frequency                   | 50-60 Hz  |
| Input Connection                  | 1 x NEMA 6-20P  |
| Input Power                       | 4160 VA(Max) 3328 VA (UL de-rated)<br>Total : 14 x IEC320 C13 + 2 x IEC320 C19  |
| Outlet Type                       | Bank1-1 : Outlet 1 – 8 ; 7 x C13 + 1 x C19<br>Bank1-2 : Outlet 9 – 16 ; 7 x C13 + 1 x C19                                 |
| Nominal Output Voltage            | 100 – 240 VAC   |
| Maximum Output Current (Outlet)   | C13 : 15A (Max) 12A(UL de-rated)<br>C19 : 20A (Max) 16A(UL de-rated)  |
| Maximum Output Current (Bank)     | 20A(Max) 16A (UL de-rated)  |
| Maximum Output Current (Total)    | 20A(Max) 16A (UL de-rated)  |
| Breakers                          | 1 x 20A Non-Fuse breaker  |
| Metering                          | Per Outlet Level Current, Voltage, VA, PF, KWh Monitoring   |
| Outlet Switch                     | Yes   |
| Environment Sensor Port           | 4   |
| Metering Accuracy                 | Voltage Range: 100VAC ~ 250VAC +/-1%<br>Power Range: 100W ~ 5000W +/- 2%<br>Current Range: 0.1A~1A +/- 0.1A, 1A~20A +/-1% |
| <b>Mechanical</b>                 |   |
| Dimension (H x W x D)             | 132.5 x 6.6 x 4.4 cm  |
| Shipping Dimensions ( H x W x D)  | 142 x 16 x 17 cm  |
| Weight/Shipping Weight            | 3.9 / 7.9 kg  |
| Power Cord Length                 | 1.6 m   |
| <b>Environmental</b>              |   |
| Temperature (Operating / Storage) | 0 – 50°C / -20 – 60°C   |
| Humidity (Operating & Storage)    | 0 – 80% RH, Non-Condensing  |
| <b>Compliance</b>                 |   |
| EMC Verification                  | FCC Part 15 Class A, Others by Reuest   |
| Safety Verification               | TUV-CB, Others by Reuest  |

### Package Contents

1. PE8216B
2. Standard Rack Mount Kit
3. Quick Start Guide
4. CD-ROM (Manual, eco Sensors Software)
5. Power Cord



Rack Mount Kit

## Optional Accessories

### Environment Sensors

| Part No. | Sensor                              |
|----------|-------------------------------------|
| EA1140   | Temperature                         |
| EA1240   | Temperature / Humidity              |
| EA1340   | Differential Pressure / Temperature |
| EA1440   | Photo Door Sensor                   |
| EA1441   | Inductive Proximity Door Sensor     |

### Cable Holders

| Part No. | Description  |
|----------|--|
| 2X-EA07  | Lok-U-Plug Cable Holder (10 pcs per pack) <b>Patent Pending!</b> |
| 2X-EA08  | Lok-U-Plug Installation Tool (4 pcs per pack)                    |

#### • Lok-U-Plug Installation



### Mounting Kit



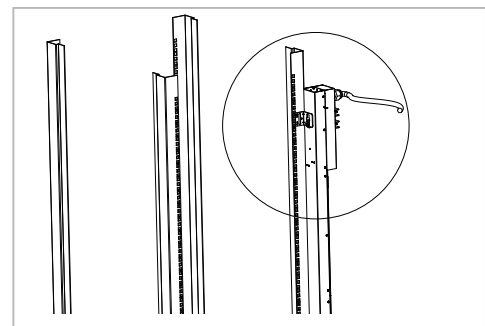

Button Mount Kit (2X-017G)

#### • Button Mount Installation



# PE8216G ECO PDU

|                       |   |
|-----------------------|---|
| Description:          | 100-240V 16A 0U 16-Outlet PDU   |
| Function:             | 16-Outlet Metering,<br>16-Outlet Switching Control &<br>1-Bank Metering   |
| Input Power Plug:     | IEC 60320 C20    |
| Power Capacity:       | 3.7 kW  |
| Socket Configuration: | IEC 60320 C19 (2) <br>IEC 60320 C13 (14)  |

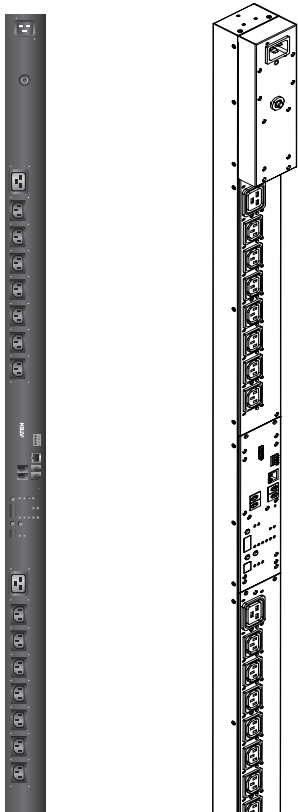

## Features

### Connections

- Supports 10/100Mbit Ethernet Interface
- Supports TCP/IP, UDP, HTTP, HTTPS, SSL, DHCP, ARP, NTP, DNS, Telnet, Auto Sense, Ping, SNMP V1,V2&V3
- Supports three-level account/password security, IP/MAC filter, 128 bit SSL, RADIUS
- Supports, eco Sensors, multiple Browsers (IE, Firefox, Chrome, Safari)

### Metering

- PDU and outlet level power metering and monitoring
- Environment monitoring – supports external temperature/temperature & humidity sensors for rack temperature and humidity monitoring
- Current, voltage, power, power dissipation, temperature, and humidity metering and threshold level setting
- Support door sensor

### Outlet Switch Control

- Remote power outlet control (On/Off, Power Cycle) by individual outlets and outlet groups
- Outlet group support at the PDU
- Supports multiple power control methods – Wake on LAN, System After AC Back, Kill the Power
- Power-On sequencing – users can set the power-on sequence and delay time for each outlet to allow equipment to be powered on in the correct order
- Proactive overload protection(POP) – automatically powers off the last outlet that caused the current overload *Patent Pending!*

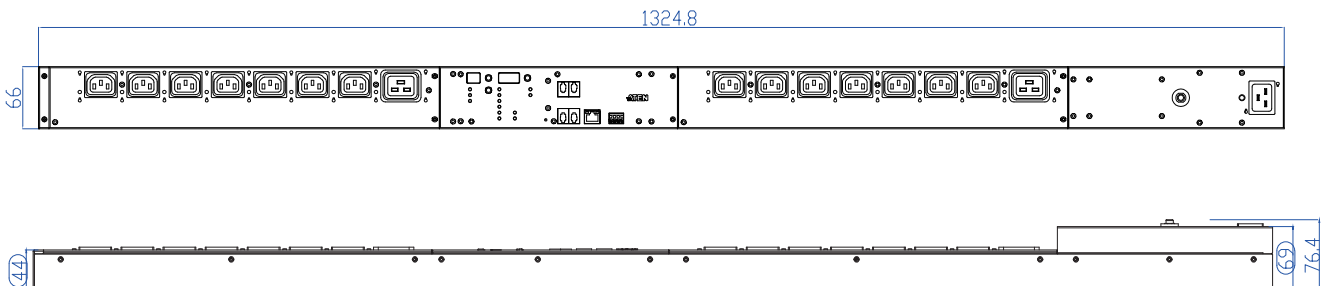

## Specifications

| Model                             | PE8216G   |
|-----------------------------------|---|
| <b>Electrical</b>                 |   |
| Nominal Input Voltage             | 100 – 240 VAC   |
| Maximum Input Current             | 16A Max   |
| Input Frequency                   | 50-60 Hz  |
| Input Connection                  | 1 x IEC60320 C20  |
| Input Power                       | 3680 VA(Max)  |
| Outlet Type                       | Total : 14 x IEC320 C13 + 2 x IEC320 C19<br>Bank1-1 : Outlet 1 – 8 ; 7 x C13 + 1 x C19<br>Bank1-2 : Outlet 9 – 16 ; 7 x C13 + 1 x C19 |
| Nominal Output Voltage            | 100 – 240 VAC   |
| Maximum Output Current (Outlet)   | C13 : 10A (Max)<br>C19 : 16A (Max) , TUV De-rated 15A(Max)  |
| Maximum Output Current (Bank)     | 16A(Max), TUV De-rated 15A(Max)   |
| Maximum Output Current (Total)    | 16A(Max), TUV De-rated 15A(Max)   |
| Breakers                          | 1 x 16A Non-Fuse breaker  |
| Metering                          | Per Outlet Level Current, Voltage, VA, PF, KWh Monitoring   |
| Outlet Switch                     | Yes   |
| Environment Sensor Port           | 4   |
| Metering Accuracy                 | Voltage Range: 100VAC ~ 250VAC +/-1%<br>Power Range: 100W ~ 5000W +/- 2%<br>Current Range: 0.1A~1A +/- 0.1A, 1A~20A +/-1%             |
| <b>Mechanical</b>                 |   |
| Dimension (H x W x D)             | 132.5 x 6.6 x 4.4 cm  |
| Shipping Dimensions ( H x W x D)  | 142 x 16 x 17 cm  |
| Weight/Shipping Weight            | 3.9 / 7.9 kg  |
| Power Cord Length                 | 1.6 m   |
| <b>Environmental</b>              |   |
| Temperature (Operating / Storage) | 0 – 40°C / -20 – 60°C   |
| Humidity (Operating & Storage)    | 0 – 80% RH, Non-Condensing  |
| <b>Compliance</b>                 |   |
| EMC Verification                  | CE, Others by Request   |
| Safety Verification               | TUV-CB, CE-LVD, Others by Request   |

### Package Contents

1. PE8216G
2. Standard Rack Mount Kit
3. Quick Start Guide
4. CD-ROM (Manual, eco Sensors Software)
5. Power Cord



Rack Mount Kit

## Optional Accessories

### Environment Sensors

| Part No. | Sensor                              |
|----------|-------------------------------------|
| EA1140   | Temperature                         |
| EA1240   | Temperature / Humidity              |
| EA1340   | Differential Pressure / Temperature |
| EA1440   | Photo Door Sensor                   |
| EA1441   | Inductive Proximity Door Sensor     |

### Cable Holders

| Part No. | Description  |
|----------|--|
| 2X-EA07  | Lok-U-Plug Cable Holder (10 pcs per pack) <b>Patent Pending!</b> |
| 2X-EA08  | Lok-U-Plug Installation Tool (4 pcs per pack)                    |

#### • Lok-U-Plug Installation



### Mounting Kit



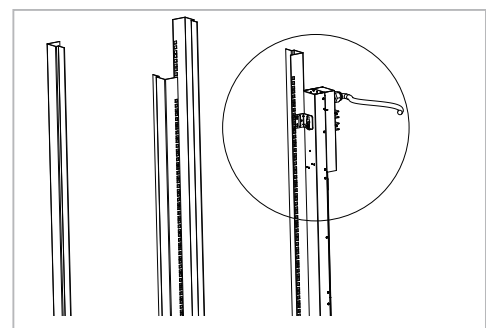

Button Mount Kit (2X-017G)

#### • Button Mount Installation



# PE8324B ECO PDU

|                       |   |
|-----------------------|---|
| Description:          | 100-240V 30A 0U 24-Outlet PDU   |
| Function:             | 24-Outlet Metering,<br>24-Outlet Switching Control &<br>2-Bank Metering   |
| Input Power Plug:     | NEMA L6-30P    |
| Power Capacity:       | 6.2 kW  |
| Socket Configuration: | IEC 60320 C19 (3) <br>IEC 60320 C13 (21)  |

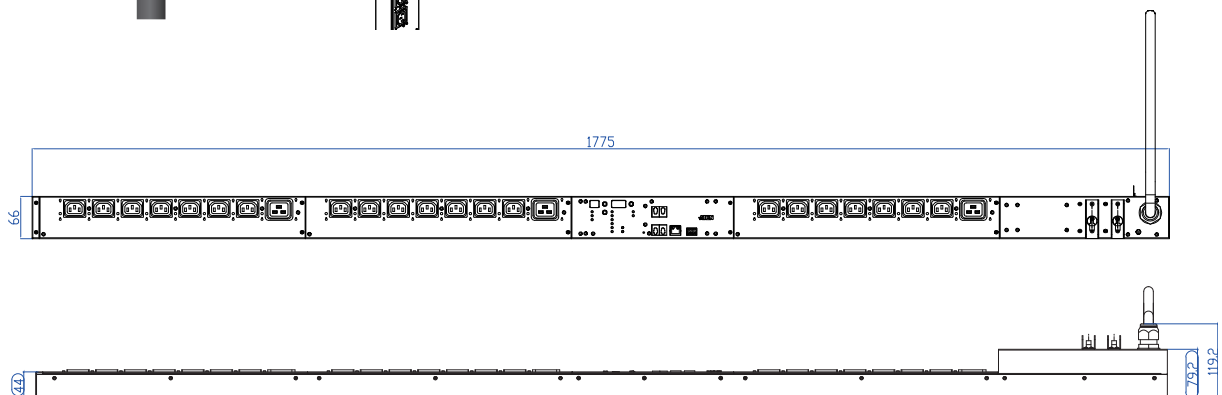
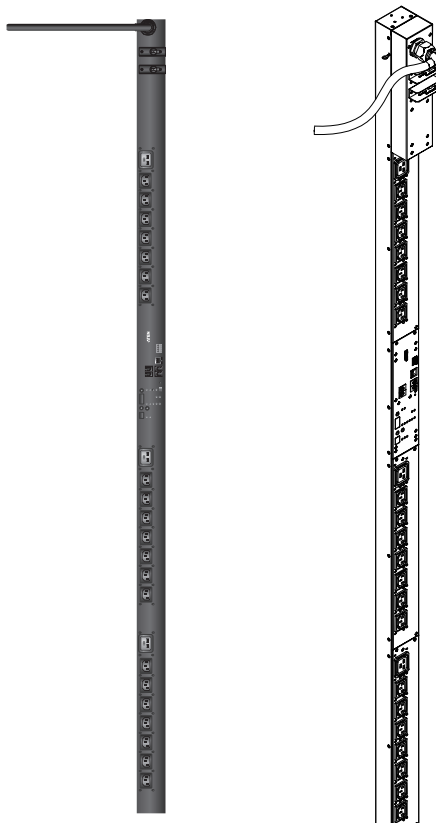

## Features

### Connections

- Supports 10/100Mbit Ethernet Interface
- Supports TCP/IP, UDP, HTTP, HTTPS, SSL, DHCP, ARP, NTP, DNS, Telnet, Auto Sense, Ping, SNMP V1,V2&V3,
- Supports three-level account/password security, IP/MAC filter, 128 bit SSL, RADIUS
- Supports, eco Sensors, multiple Browsers (IE, Firefox, Chrome, Safari)

### Metering

- PDU and outlet level power metering and monitoring
- Environment monitoring – supports external temperature/temperature & humidity sensors for rack temperature and humidity monitoring
- Current, voltage, power, power dissipation, temperature, and humidity metering and threshold level setting
- Support door sensor

### Outlet Switch Control

- Remote power outlet control (On/Off, Power Cycle) by individual outlets and outlet groups
- Outlet group support at the PDU
- Supports multiple power control methods – Wake on LAN, System After AC Back, Kill the Power
- Power-On sequencing – users can set the power-on sequence and delay time for each outlet to allow equipment to be powered on in the correct order
- Proactive overload protection(POP) – automatically powers off the last outlet that caused the current overload *Patent Pending!*

| Model                             | PE8324B   |
|-----------------------------------|---|
| <b>Electrical</b>                 |   |
| Nominal Input Voltage             | 100 – 240 VAC   |
| Maximum Input Current             | 30A Max ; 24A (UL de-rated)   |
| Input Frequency                   | 50-60 Hz  |
| Input Connection                  | NEMA L6-30P   |
| Input Power                       | 6240 VA(Max) 4992 VA (UL de-rated)  |
| Outlet Type                       | Total : 21 x IEC320 C13 + 3 x IEC320 C19<br>Bank1-1 : Outlet 1 – 8 ; 7 x C13 + 1 x C19<br>Bank1-2 : Outlet 9 – 16 ; 7 x C13 + 1 x C19<br>Bank2 : Outlet 17 – 24 ; 7 x C13 + 1 x C19 |
| Nominal Output Voltage            | 100 – 240 VAC   |
| Maximum Output Current (Outlet)   | C13 : 15A (Max) 12A(UL de-rated)<br>C19 : 15A (Max) 12A(UL de-rated)  |
| Maximum Output Current (Bank)     | 15A(Max) 12A (UL de-rated)  |
| Maximum Output Current (Total)    | 30A(Max) 24A (UL de-rated)  |
| Breakers                          | 2 x 16A UL489 Breaker   |
| Metering                          | Per Outlet Level Current, Voltage, VA, PF, KWh Monitoring   |
| Outlet Switch                     | Yes   |
| Environment Sensor Port           | 4   |
| Metering Accuracy                 | Voltage Range: 100VAC ~ 250VAC +/-1%<br>Power Range: 100W ~ 5000W +/- 2%<br>Current Range: 0.1A~1A +/- 0.1A, 1A~20A +/-1%   |
| <b>Mechanical</b>                 |   |
| Dimension (H x W x D)             | 177.5 x 6.6 x 4.4 cm  |
| Shipping Dimensions ( H x W x D)  | 189 x 21 x 17 cm  |
| Weight/Shipping Weight            | 6.5 / 10.5 kg   |
| Power Cord Length                 | 1.6 m   |
| <b>Environmental</b>              |   |
| Temperature (Operating / Storage) | 0 – 50°C / -20 – 60°C   |
| Humidity (Operating & Storage)    | 0 – 80% RH, Non-Condensing  |
| <b>Compliance</b>                 |   |
| EMC Verification                  | FCC Part 15 Class A, Others by Reuest   |
| Safety Verification               | TUV-CB, Others by Reuest  |

### Package Contents

1. PE8324B
2. Standard Rack Mount Kit
3. Quick Start Guide
4. CD-ROM (Manual, eco Sensors Software)



Rack Mount Kit

### Environment Sensors

| Part No. | Sensor                              |
|----------|-------------------------------------|
| EA1140   | Temperature                         |
| EA1240   | Temperature / Humidity              |
| EA1340   | Differential Pressure / Temperature |
| EA1440   | Photo Door Sensor                   |
| EA1441   | Inductive Proximity Door Sensor     |

### Cable Holders

| Part No. | Description  |
|----------|--|
| 2X-EA07  | Lok-U-Plug Cable Holder (10 pcs per pack) <b>Patent Pending!</b> |
| 2X-EA08  | Lok-U-Plug Installation Tool (4 pcs per pack)                    |

#### • Lok-U-Plug Installation



### Mounting Kit



Slide Rail Kit (2X-016G)



Button Mount Kit (2X-017G)



#### • Side Mount Installation

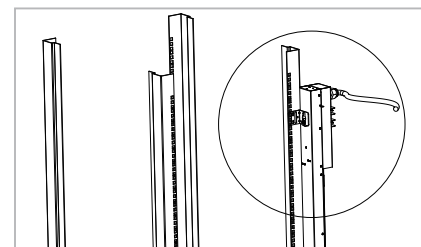

#### • Button Mount Installation



# PE8324G ECO PDU

|                       |   |
|-----------------------|---|
| Description:          | 100-240V 32A 0U 24-Outlet PDU   |
| Function:             | 24-Outlet Metering,<br>24-Outlet Switch Control & 2-Bank<br>Metering  |
| Input Power Plug:     | IEC 60309 32A    |
| Power Capacity:       | 7.4 kW  |
| Socket Configuration: | IEC 60320 C19 (3) <br>IEC 60320 C13 (21)  |

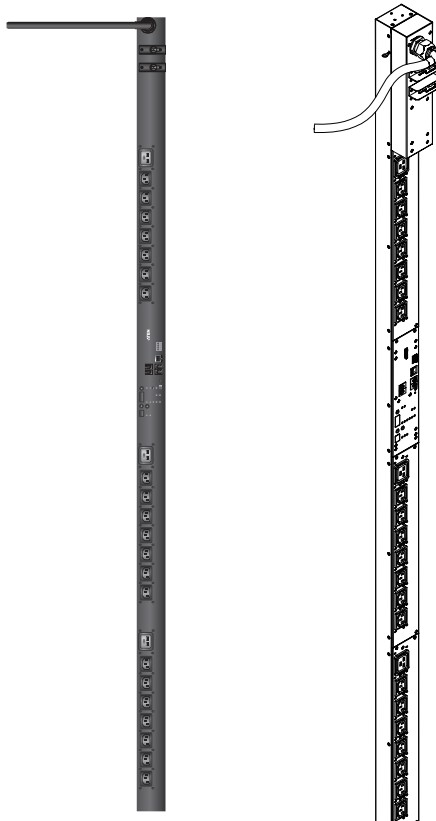

## Features

### Connections

- Supports 10/100Mbit Ethernet Interface
- Supports TCP/IP, UDP, HTTP, HTTPS, SSL, DHCP, ARP, NTP, DNS, Telnet, Auto Sense, Ping, SNMP V1,V2&V3,
- Supports three-level account/password security, IP/MAC filter, 128 bit SSL, RADIUS
- Supports, eco Sensors, multiple Browsers (IE, Firefox, Chrome, Safari)

### Metering

- PDU and outlet level power metering and monitoring
- Environment monitoring – supports external temperature/temperature & humidity sensors for rack temperature and humidity monitoring
- Current, voltage, power, power dissipation, temperature, and humidity metering and threshold level setting
- Support door sensor

### Outlet Switch Control

- Remote power outlet control (On/Off, Power Cycle) by individual outlets and outlet groups
- Outlet group support at the PDU
- Supports multiple power control methods – Wake on LAN, System After AC Back, Kill the Power
- Power-On sequencing – users can set the power-on sequence and delay time for each outlet to allow equipment to be powered on in the correct order
- Proactive overload protection(POP) – automatically powers off the last outlet that caused the current overload *Patent Pending!*

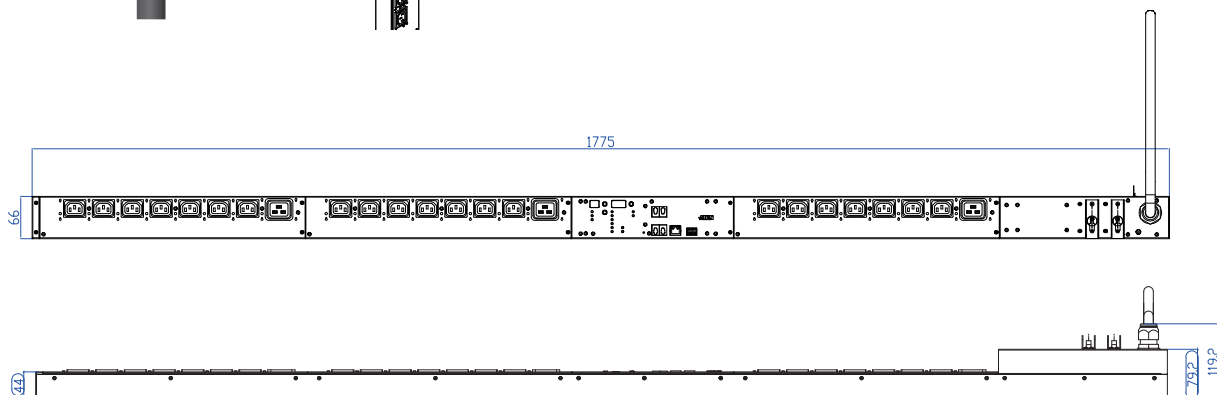



## Specifications

| Model                             | PE8324G   |
|-----------------------------------|---|
| <b>Electrical</b>                 |   |
| Nominal Input Voltage             | 100 – 240 VAC   |
| Maximum Input Current             | 32A Max   |
| Input Frequency                   | 50-60 Hz  |
| Input Connection                  | IEC 60309 32A   |
| Input Power                       | 7360 VA(Max)  |
| Outlet Type                       | Total : 21 x IEC320 C13 + 3 x IEC320 C19<br>Bank1-1 : Outlet 1 – 8 ; 7 x C13 + 1 x C19<br>Bank1-2 : Outlet 9 – 16 ; 7 x C13 + 1 x C19<br>Bank2 : Outlet 17 – 24 ; 7 x C13 + 1 x C19 |
| Nominal Output Voltage            | 100 – 240 VAC   |
| Maximum Output Current (Outlet)   | C13 : 10A (Max)<br>C19 : 16A (Max), TUV De-rated 15A(Max)   |
| Maximum Output Current (Bank)     | 16A(Max), TUV De-rated 15A(Max)   |
| Maximum Output Current (Total)    | 32A(Max), TUV De-rated 30A(Max)   |
| Breakers                          | 2 x 16A UL489 Breaker   |
| Metering                          | Per Outlet Level Current, Voltage, VA, PF, KWh Monitoring   |
| Outlet Switch                     | Yes   |
| Environment Sensor Port           | 4   |
| Metering Accuracy                 | Voltage Range: 100VAC ~ 250VAC +/-1%<br>Power Range: 100W ~ 5000W +/- 2%<br>Current Range: 0.1A~1A +/- 0.1A, 1A~20A +/-1%   |
| <b>Mechanical</b>                 |   |
| Dimension (H x W x D)             | 177.5 x 6.6 x 4.4 cm  |
| Shipping Dimensions (H x W x D)   | 189 x 21 x 17 cm  |
| Weight/Shipping Weight            | 6.5 / 10.5 kg   |
| Power Cord Length                 | 1.6 m   |
| <b>Environmental</b>              |   |
| Temperature (Operating / Storage) | 0 – 40°C / -20 – 60°C   |
| Humidity (Operating & Storage)    | 0 – 80% RH, Non-Condensing  |
| <b>Compliance</b>                 |   |
| EMC Verification                  | CE, Others by Request   |
| Safety Verification               | TUV-CB, CE-LVD, Others by Request   |

### Package Contents

1. PE8324G
2. Standard Rack Mount Kit
3. Quick Start Guide
4. CD-ROM (Manual, eco Sensors Software)



Rack Mount Kit

## Optional Accessories

### Environment Sensors

| Part No. | Sensor                              |
|----------|-------------------------------------|
| EA1140   | Temperature                         |
| EA1240   | Temperature / Humidity              |
| EA1340   | Differential Pressure / Temperature |
| EA1440   | Photo Door Sensor                   |
| EA1441   | Inductive Proximity Door Sensor     |

### Cable Holders

| Part No. | Description  |
|----------|--|
| 2X-EA07  | Lok-U-Plug Cable Holder (10 pcs per pack) <b>Patent Pending!</b> |
| 2X-EA08  | Lok-U-Plug Installation Tool (4 pcs per pack)                    |

#### • Lok-U-Plug Installation



### Mounting Kit



Slide Rail Kit (2X-016G)



Button Mount Kit (2X-017G)

#### • Side Mount Installation



#### • Button Mount Installation

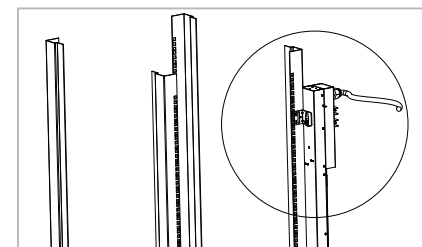

### ATEN International Co., Ltd.

3F., No.125, Sec. 2, Datong Rd., Sijhih District., New Taipei City 221, Taiwan  
 Phone: 886-2-8692-6789 Fax: 886-2-8692-6767  
 www.aten.com E-mail: marketing@aten.com

NRGence\_Full\_Catalog\_V1\_2013\_01



© Copyright 2013 ATEN® International Co., Ltd.  
 ATEN and the ATEN logo are trademarks of ATEN International Co., Ltd.  
 All rights reserved. All other trademarks are the property of their respective owners.