



# 1000W Intelligent Single Output Battery Charger

# PB-1000 series



### ■ Features :

- Controlled by microprocessor
- 2/3/8 stage charging selectable on output panel (Note 4)
- Universal AC input / Full range
- Built-in active PFC function PF>0.95
- Protection: Reverse Polarity / Short circuit / Over voltage / Over temperature
- Charger for lead-acid batteries
- 3 color LED loading indicator
- Built-in remote ON-OFF control
- 2-Bank charger
- Temperature compensation function
- FAN on/off control (depends on charging current)
- 3 years warranty



### SPECIFICATION

MODEL	PB-1000-12	PB-1000-24	PB-1000-48	
OUTPUT	BOOST CHARGE VOLTAGE	14.4V	28.8V	57.6V
	FLOAT CHARGE VOLTAGE	13.8V	27.6V	55.2V
	OUTPUT CURRENT	60A	34.7A	17.4A
	RECOMMENDED BATTERY CAPACITY(AMP HOURS)(Note 3)	200 ~ 600Ah	120 ~ 350Ah	60 ~ 175Ah
	BATTERY TYPE	Open & Sealed Lead Acid		
	LEAKAGE CURRENT FROM BATTERY (Typ.)	<1mA		
INPUT	VOLTAGE RANGE	90 ~ 264VAC    127 ~ 370VDC		
	FREQUENCY RANGE	47 ~ 63Hz		
	POWER FACTOR (Typ.)	0.95/230VAC	0.98/115VAC at full load	
	EFFICIENCY (Typ.)	85%	88%	89%
	AC CURRENT (Typ.)	12A/115VAC	5.2A/230VAC	
	INRUSH CURRENT (Typ.)	25A/115VAC	50A/230VAC	
	LEAKAGE CURRENT	<3.5mA / 240VAC		
PROTECTION	OVER VOLTAGE	16 ~ 18V	32 ~ 35V	64.5 ~ 69.5V
		Protection type : Shut down o/p voltage, re-power on to recover		
	OVER TEMPERATURE	Shut down o/p voltage, recovers automatically after temperature goes down		
	SHORT CIRCUIT	YES, protected by internal circuit		
	REVERSE POLARITY	YES, protected by internal circuit		
FUNCTION	REMOTE CONTROL	Open: Normal work    Short: Stop Charging		
	BATTER BANKS	2 banks (A & B)		
	FAST CHARGE	2 / 3 / 8 stage selectable		
	CHARGER OK	Relay contact rating(max.): 30V/1A resistive ; "Short" when the unit is working properly, "Open"when the unit is failure or the protection function is activating		
	OUTPUT OK	Relay contact rating(max.): 30V/1A resistive ; "Short" when the battery is full, "Open" when the battery is still charging		
	TEMPERATURE COMPENSATION	By NTC, compensate both banks at the same time		
ENVIRONMENT	WORKING TEMP.	-20 ~ +60°C (Refer to "Derating Curve")		
	WORKING HUMIDITY	20 ~ 90% RH non-condensing		
	STORAGE TEMP., HUMIDITY	-40 ~ +85°C, 10 ~ 95% RH		
	TEMP. COEFFICIENT	±0.05%/°C (0 ~ 50°C)		
	VIBRATION	10 ~ 500Hz, 2G 10min./1cycle, 60min. each along X, Y, Z axes		
SAFETY & EMC (Note 2)	SAFETY STANDARDS	UL60950-1, TUV EN60950-1 approved		
	WITHSTAND VOLTAGE	I/P-O/P:3KVAC    I/P-FG:2KVAC    O/P-FG:0.5KVAC		
	ISOLATION RESISTANCE	I/P-O/P, I/P-FG, O/P-FG:100M Ohms / 500VDC / 25°C / 70% RH		
	EMC EMISSION	Compliance to EN55022 (CISPR22), EN61000-3-2,-3		
	EMC IMMUNITY	Compliance to EN61000-4-2,3,4,5,6,8,11, EN55024, light industry level, criteria A		
OTHERS	MTBF	127.4K hrs min.    MIL-HDBK-217F (25°C)		
	DIMENSION	300*184*70mm(L*W*H)		
	PACKING	3.5Kg; 4pcs/15Kg/1.83CUFT		
NOTE	<ol style="list-style-type: none"> <li>1. All parameters NOT specially mentioned are measured at 230VAC input, rated load and 25°C of ambient temperature.</li> <li>2. The power supply is considered a component which will be installed into a final equipment. The final equipment must be re-confirmed that it still meets EMC directives.</li> <li>3. This is Mean Well's suggested range. Please consult your battery manufacturer for their suggestions about maximum charging current limitation.</li> <li>4. Please choose the "3 stage" selection when the charger is used to charge the batteries and power the loads in the same time.</li> </ol>			

■ Mechanical Specification

Case No. 804B Unit:mm

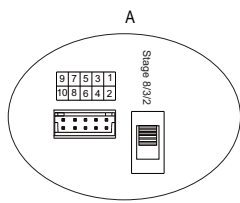
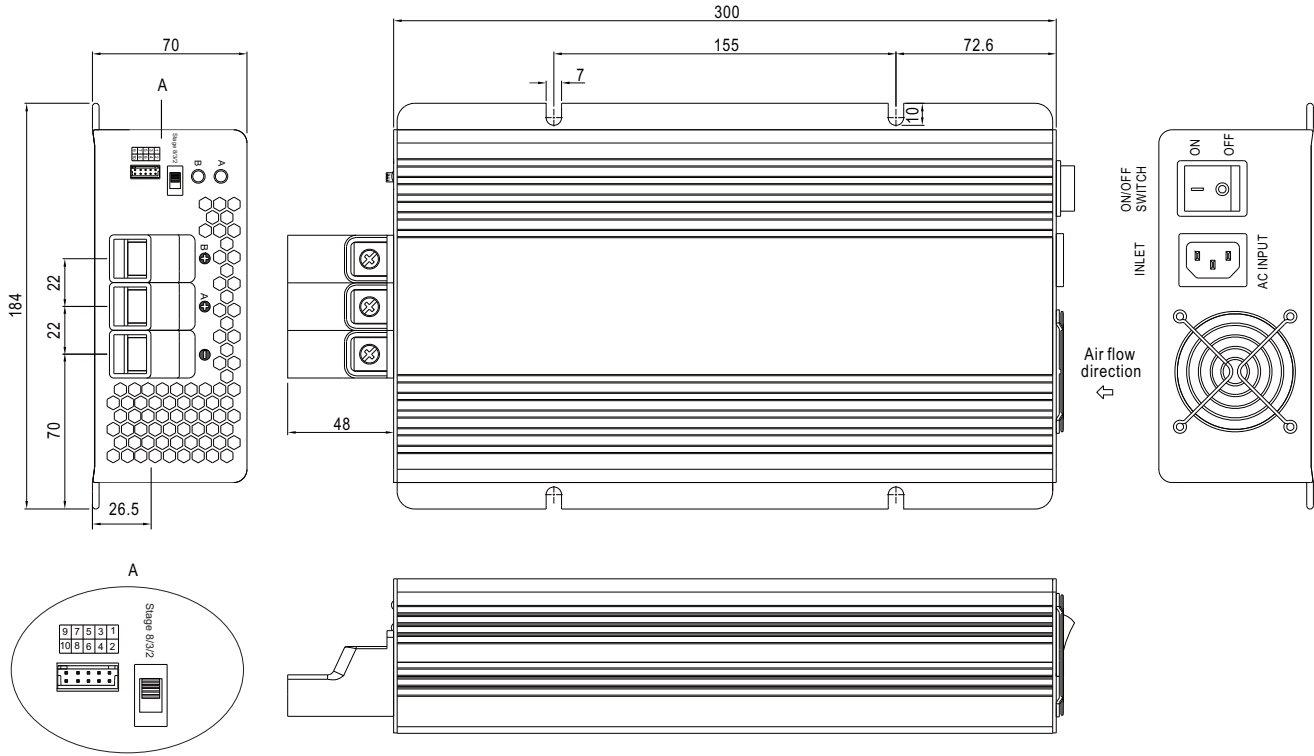

Control Pin No. Assignment(CN100) : HRS DF11-10DP-2DS or equivalent

Pin No.	Assignment	Pin No.	Assignment	Mating Housing	Terminal
1,2	RY13	8	NTC(5KΩ)	HRS DF11-10DS or equivalent	HRS DF11-10DS or equivalent
3,4	RY14	9	RC-		
5,6	RY15	10	RC+		
7	GND				

RY13 : Bank A OK      NTC / GND : Temperature sense  
 RY14 : Bank B OK      RC+ / RC- : Remote ON/OFF  
 RY15 : Charger OK

■ Charging Curve

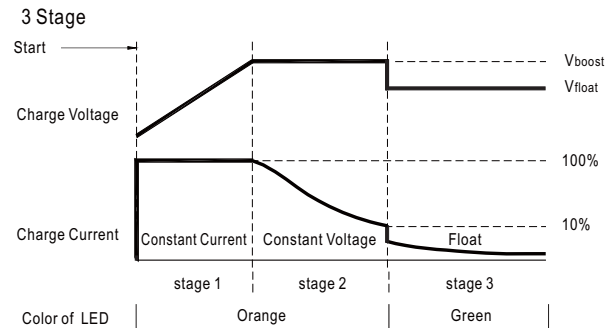
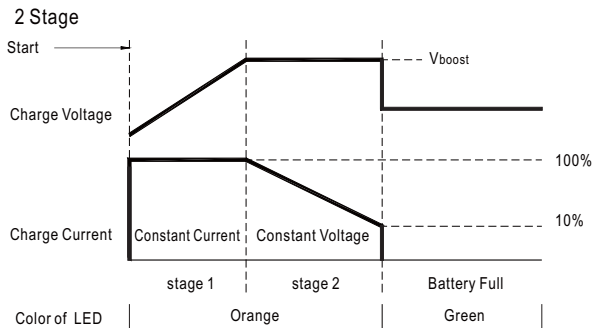

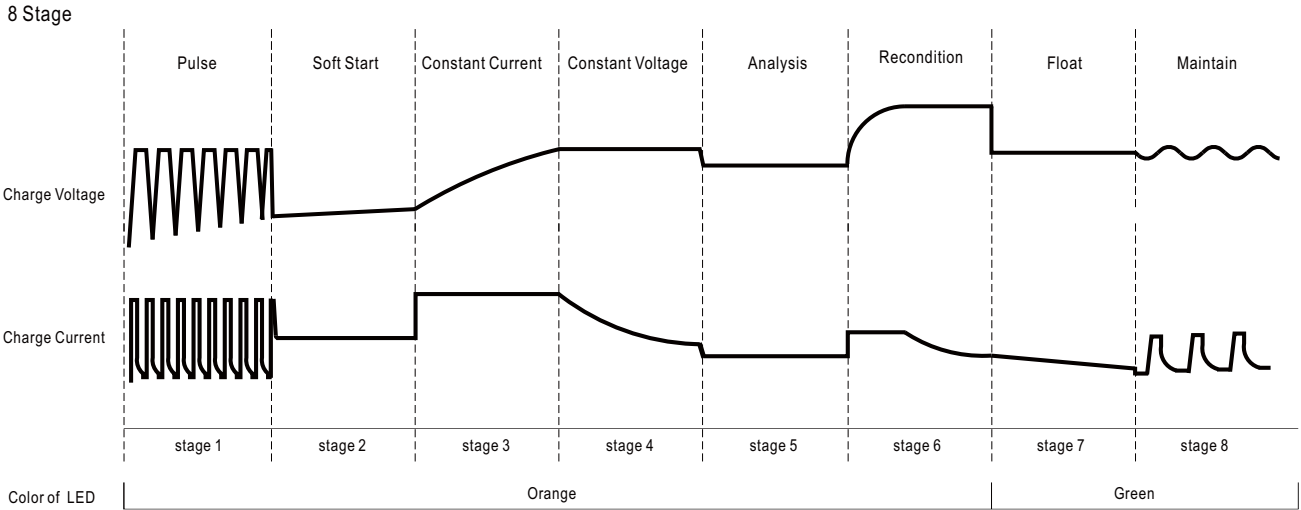

**Block Diagram**

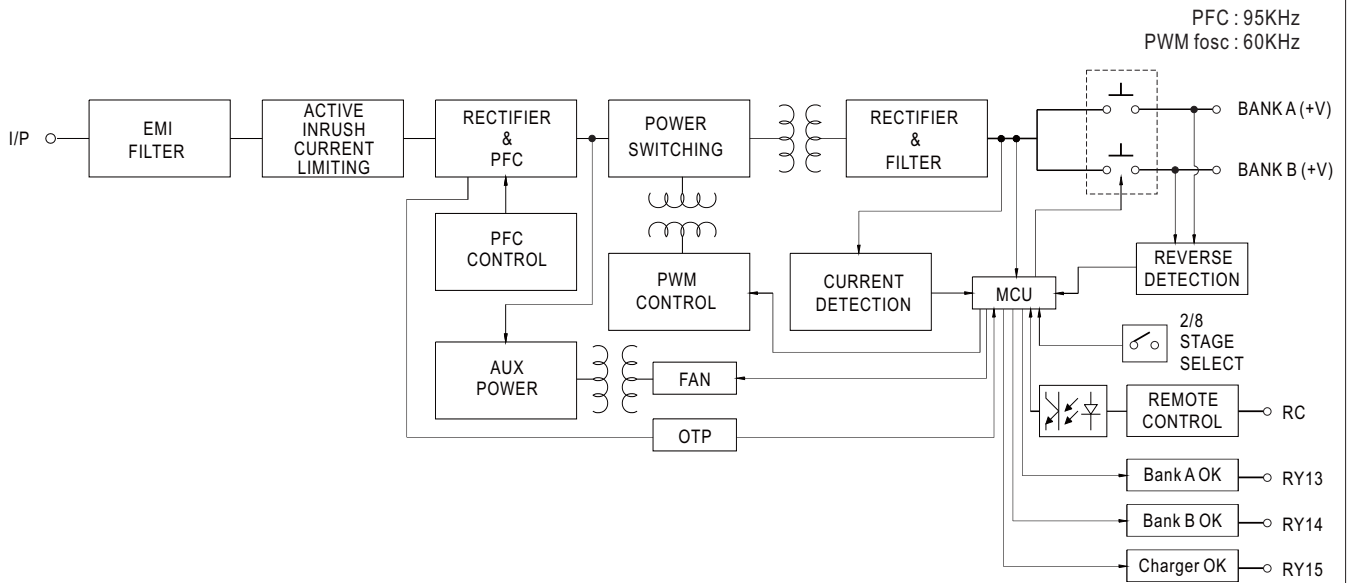

**Derating Curve**

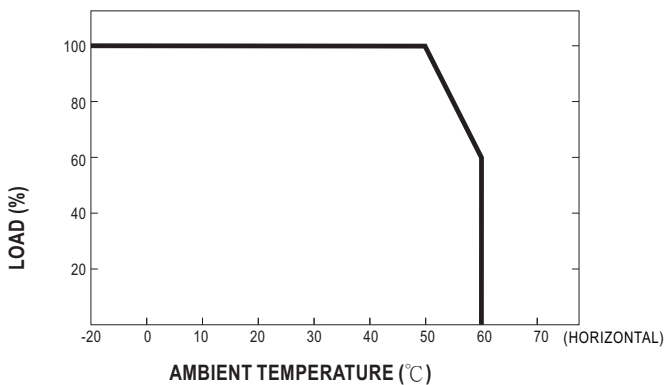

**The Function of LEDs**

Color	Status	Steady	Flashing
	● Red	Fail	
● Orange			Charging
● Green	Full		Charging

■ **Function Description of CN100**

Pin No.	Function	Description
1,2	RY13	Relay contact rating(max.): 30V/1A resistive. ; "Short" when the battery A is full, "Open" when the battery A is still charging.
3,4	RY14	Relay contact rating(max.): 30V/1A resistive. ; "Short" when the battery B is full, "Open" when the battery B is still charging.
5,6	RY15	Relay contact rating(max.): 30V/1A resistive. ; "Short" when the unit is working properly, "Open" when the unit is failure or the protection function is activating.
7,8	GND / RTH	Temperature sensor comes along with the charger can be connected to the unit to allow temperature compensation of the charging voltage. <b>If the temperature sensor is not used, the charger still works normally.</b>
9,10	RC- / RC+	Turn the output on and off by electrical or dry contact between pin 10 (RC+) and pin 9(RC-), "Open" : Normal work , "Short" : Stop charging

■ **Function Manual**

**1.Remote Control**

The charger can be turned ON/OFF by using the "Remote Control" function.

Between RC+(pin10) and RC-(pin9)	Charger
SW Open	ON
SW Short	OFF

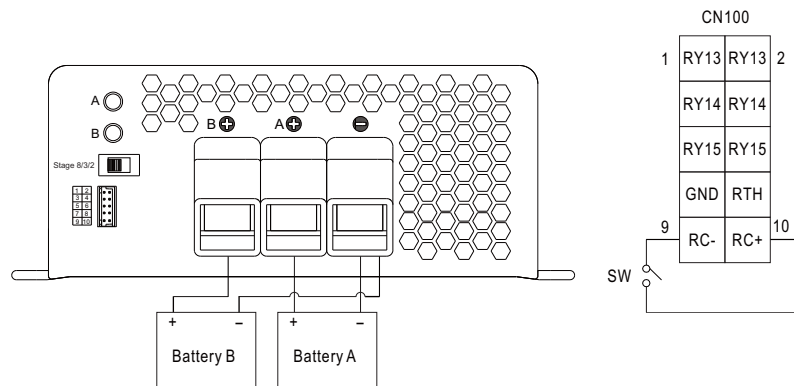

**2.Two Battery Banks (2/8 stage only)**

The charger may be hooked up two battery banks (A and/or B). Connect the battery bank(s) as below. If you are connecting 2 battery banks in the same time, keep in mind that they must share a common ground.

NOTE: The charger will charge bank A first then bank B if both channels are connected.

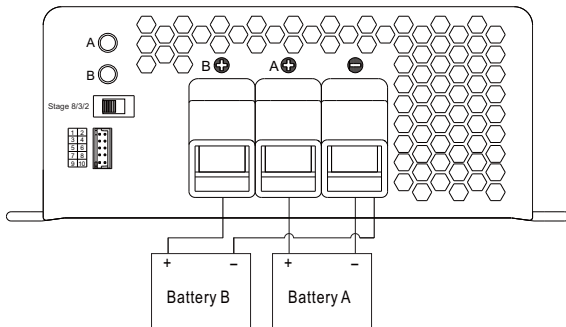
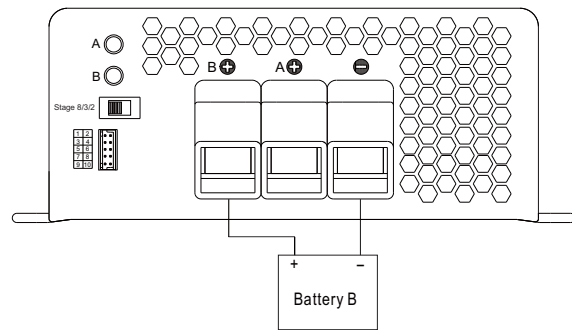
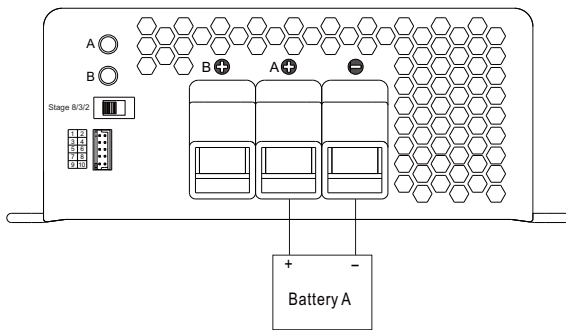

**3. 2,3, or 8 stage Charging Select**

(1)The charger features user selectable 2,3, or 8 stage charging.

The charging profile is selected by moving the slide switch on the back panel.

Switch	Charging mode
Right	2 stage charging
Middle	3 stage charging
Left	8 stage charging

(2)Please choose the "3 stage" selection when the charger is used to charge the batteries and power the loads in the same time.

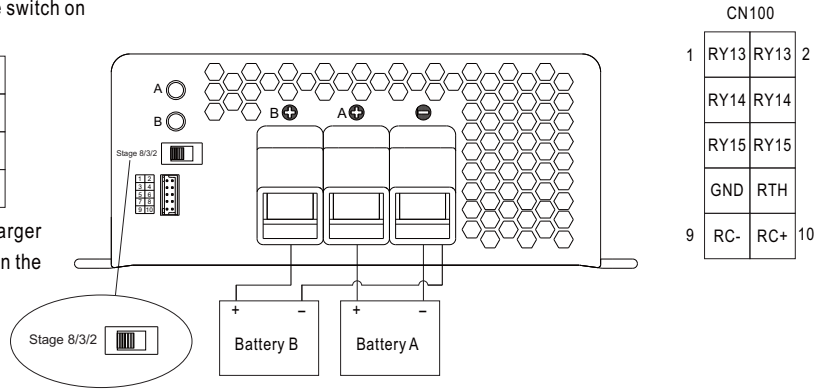

**4.Charger OK Relay(RY15)**

Charger	Between pin5 and pin6(RY15)
Normal work	ON (Short)
Failure or the protection function is activating	OFF (Open)

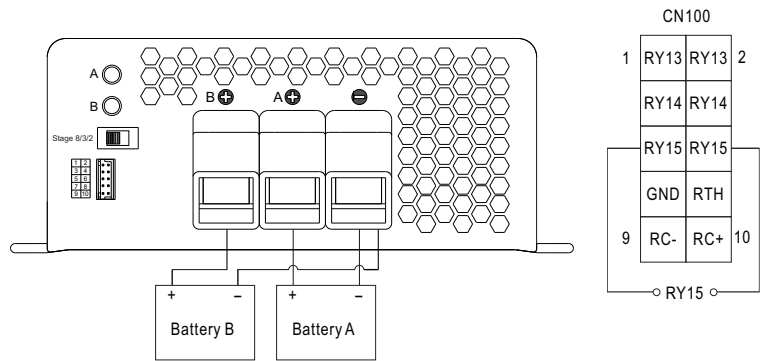

**5.Output OK Relay(RY13 & RY14)**

**1.Bank A OK (RY13)**

Bank A	Between pin1 and pin2(RY13)	Color of LED A
Battery A Full	ON (Short)	Green
Charging	OFF (Open)	Orange

**2.Bank B OK (RY14)**

Bank B	Between pin3 and pin4(RY14)	Color of LED B
Battery B Full	ON (Short)	Green
Charging	OFF (Open)	Orange

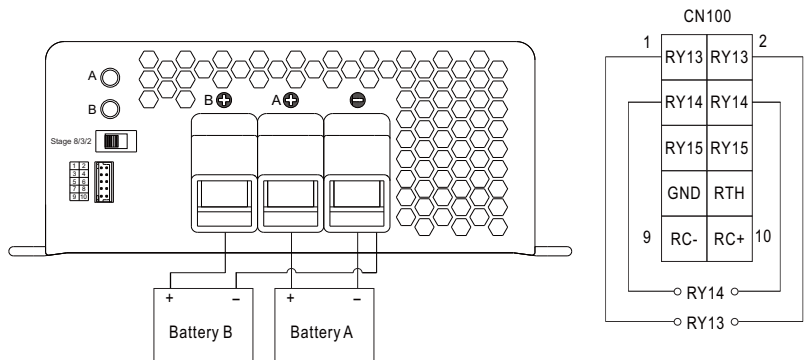

**6.Temperature Compensation**

Temperature sensor comes along with the charger can be connected to the unit to allow temperature compensation of the charging voltage.

**If the temperature sensor is not used, the charger still works normally.**

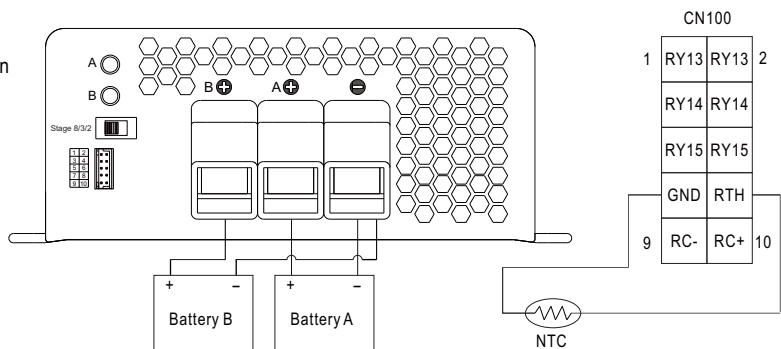

The temperature sensor can either be attached to the battery or placed in its surrounding environment.