

## OTe 10/220...240/700 PC

OPTOTRONIC Phase-cut OTE | Compact constant current LED driver – Dimmable



### Product family features

- Dimmable via leading edge/trailing edge
- Type of protection: IP20

### Product family benefits

- Compact housing for mounting in very tight spaces
- Compatible with the most common leading-edge and trailing-edge phase dimmers

### Areas of application

- Optional cable clamp E-style for independent mounting
- Suitable for indoor installations
- Suitable for indoor SELV installations



## Technical data

### Electrical data

Nominal input voltage	220...240 V
Mains frequency	50/60 Hz
Input voltage AC	198...264 V <sup>1)</sup>
Total harmonic distortion	< 20 %
Power factor $\lambda$	0.95/0.90 <sup>2)</sup>
Efficiency in full-load	79 % <sup>3)</sup>
Device power loss	2.8 W <sup>4)</sup>
Inrush current	5 A <sup>5)</sup>
Max. ECG no. on circuit breaker 10 A (B)	101
Max. ECG no. on circuit breaker 16 A (B)	160
Max. ECG no. on circuit breaker 25 A (B)	-
Surge capability (L/N-Ground)	1 kV
Surge capability (L-N)	1 kV
Nominal output voltage	7...14 V
U-OUT (working voltage)	25 V
Nominal output current	700 mA <sup>6)</sup>
Output current tolerance	±10 %
Output ripple current (100 Hz)	35 % <sup>7)</sup>
Output PSTLM	≤1
Output SVM	≤1.0
Nominal output power	10 W <sup>8)</sup>
Maximum output power	10 W
Galvanic isolation	SELV

<sup>1)</sup> Permitted voltage range

<sup>2)</sup> Full load at 230 V/Minimum load at 230 V

<sup>3)</sup> at 230 V, 50 Hz

<sup>4)</sup> Maximum

<sup>5)</sup>  $t_{width} = 100 \mu s$  (measured at 50 %  $I_{peak}$ )

<sup>6)</sup> ±10%

<sup>7)</sup> Typical

<sup>8)</sup> Partial load 5...10 W

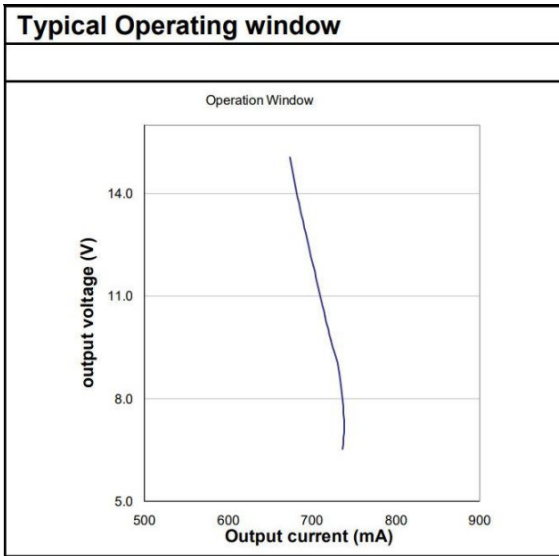

OTE 10220-240700 PC Operating Window

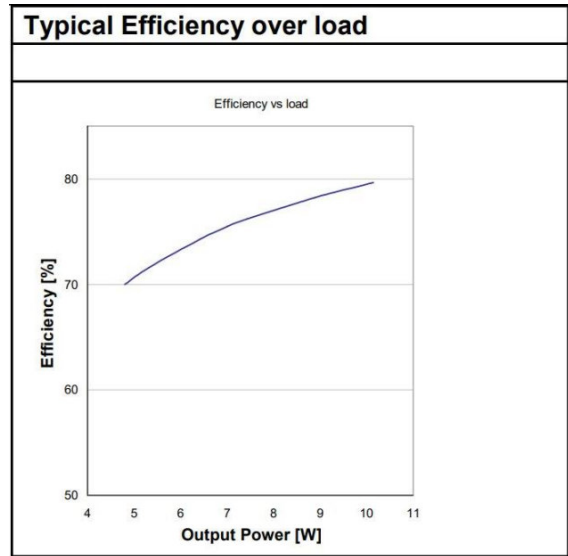

OTE 10220-240700 PC Typical Efficiency vs. Load (230 V 50 Hz)

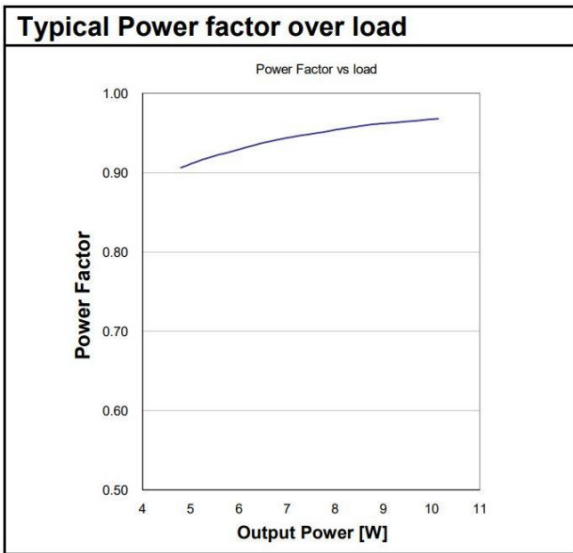

OTE 10220-240700 PC Typical Power Factor vs. Load

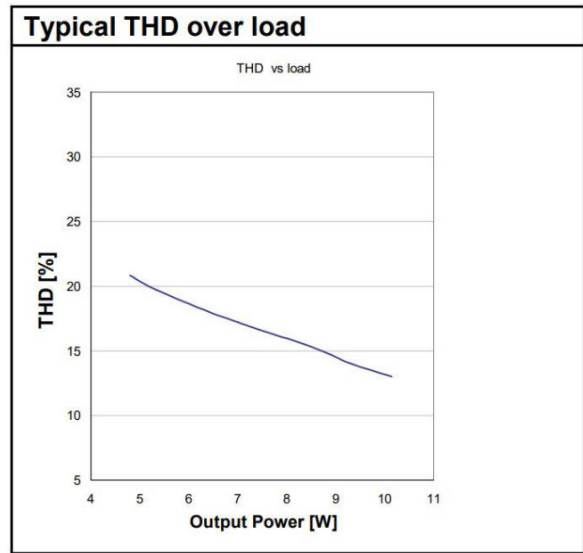

OTE 10220-240700 PC Typical THD Vs Load

## Dimensions & weight

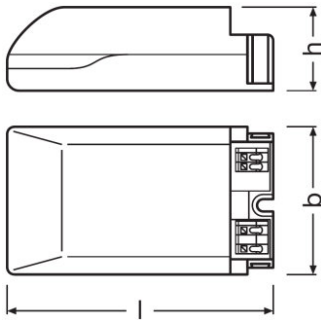

<b>Mounting hole spacing, length</b>	-
<b>Mounting hole spacing, width</b>	-
<b>Product weight</b>	81.00 g
<b>Cable cross-section, input side</b>	0.75...1.5 mm <sup>2</sup> <sup>1)</sup>
<b>Cable cross-section, output side</b>	0.5...1.5 mm <sup>2</sup> <sup>1)</sup>
<b>Wire preparation length, input side</b>	8.0...9.0 mm
<b>Wire preparation length, output side</b>	8.0...9.0 mm
<b>Length</b>	95.0 mm
<b>Width</b>	53.0 mm
<b>Height</b>	25.0 mm

<sup>1)</sup> Flexible / Solid leads

## Colors & materials

<b>Casing material</b>	Plastic
------------------------	---------

## Temperatures & operating conditions

<b>Ambient temperature range</b>	-20...+55 °C
<b>Maximum temperature at tc test point</b>	80 °C <sup>1)</sup>
<b>Max.housing temperature in case of fault</b>	110 °C
<b>Temperature range at storage</b>	-25...75 °C
<b>Permitted rel. humidity during operation</b>	5...85 % <sup>2)</sup>

<sup>1)</sup> Maximum at the T<sub>c</sub>-point

<sup>2)</sup> Maximum 56 days/year at 85 %

## Lifespan

<b>ECG lifetime</b>	50000 h <sup>1)</sup>
---------------------	-----------------------

<sup>1)</sup> At  $T_{case} = 70^{\circ}C$  at  $T_c$  point / 10% failure rate

### Capabilities

<b>Dimmable</b>	Yes
<b>Dimming interface</b>	Phase Cut <sup>1)</sup>
<b>Dimming range</b>	10...100 %
<b>Dimming method</b>	Amplitude Modulation
<b>Overheating protection</b>	Automatic reversible
<b>Overload protection</b>	Automatic reversible
<b>Short-circuit protection</b>	Automatic reversible
<b>No-load proof</b>	Yes
<b>Intended for no-load operation</b>	No
<b>Max. cable length to lamp/LED module</b>	2.0 m
<b>Suitable for fixtures with prot. class</b>	I / II
<b>Type of connection, output side</b>	Push terminal

<sup>1)</sup> Trailing edge / Leading edge





### Certificates & standards

<b>Approval marks – approval</b>	CE / ENEC 10 / VDE / CB
<b>Standards</b>	Acc. to IEC 61347-1/Acc. to IEC 61347-2-13/Acc. to IEC 62384/Acc. to CISPR 15/Acc. to IEC 61000-3-2/Acc. to IEC 61000-3-3/Acc. to IEC 61547
<b>Protection class</b>	II
<b>Type of protection</b>	IP20





### Logistical data

<b>Commodity code</b>	850440829000
-----------------------	--------------

### Download Data

File	
	Certificates OT EMC 40038482 220421
	Certificates OT ENEC 40038447 210721
	Certificates 496535_CB report OTe 10 700 PC and OTe 13 350 PC
	Declarations of conformity OTe PC UK DoC 4281102 180221
	Declarations of conformity OTE PC CE 3365230 230821

## Product datasheet

	Installation/Operation notice OT PC dimmer list (EN)
	Installation guide 501498_OTe 10220-240700 PC
	CAD data 3-dim 377012_OTe 10-13 PC -cable clamp
	CAD data 3-dim 377013_OTe 10-13 PC -housing
	CAD data 3-dim 377014_OTe 10-13 PC -housing with cable clamp

### Ecodesign regulation information:

Intended for use with LED modules.

The forward voltage of the LED light source shall be within the defined operating window of the control gear in all operating conditions including dimming if applicable.

Separate control gear and light sources must be disposed of at certified disposal companies in accordance with Directive 2012/19/EU (WEEE) in the EU and with Waste Electrical and Electronic Equipment (WEEE) Regulations 2013 in the UK. For this purpose, collection points for recycling centres and take-back systems (CRSO) are available from retailers or private disposal companies, which accept separate control gear and light sources free of charge. In this way, raw materials are conserved and materials are recycled.

### Logistical Data

Product code	Product description	Packaging unit (Pieces/Unit)	Dimensions (length x width x height)	Volume	Gross weight
4052899105300	OTe 10/220...240/700 PC	Shipping carton box 20	284 mm x 207 mm x 96 mm	5.64 dm <sup>3</sup>	1890.00 g

The mentioned product code describes the smallest quantity unit which can be ordered. One shipping unit can contain one or more single products. When placing an order, for the quantity please enter single or multiples of a shipping unit.

### Accessories Optional

Product description	Accessory name	Accessory code
OTe 10/220...240/700 PC	OT CABLE CLAMP E-STYLE	▶ 4052899167896

### Disclaimer

Subject to change without notice. Errors and omission excepted. Always make sure to use the most recent release.