

**New Products**

**CONTACT** No. 313

**NIKK**  
SWITCHES  
*Innovation Driving Quality*

# Provides Crisp Feedback

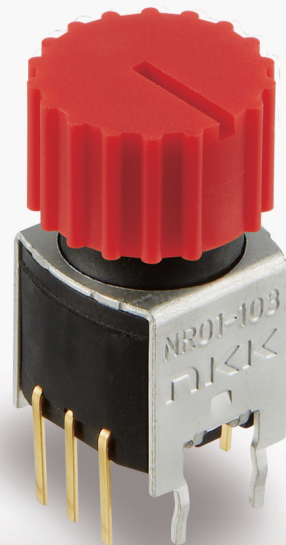
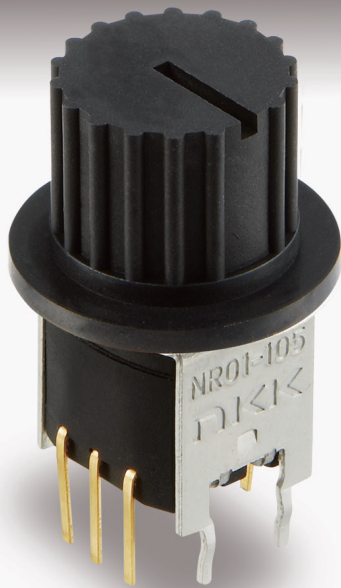

## NR01 Series Miniature Rotaries

**NKK SWITCHES CO., LTD.**

(Registered design)

## Provides Crisp Feedback in Miniature Body

### ☞ Fully Washable

The switch contacts feature a sealed design enabling automated soldering and cleaning.

### ☞ Light Operating Feel

The switching mechanism uses a steel ball to ensure light operation and positive feeling of actuation.

### ☞ Locking Out Flux

Insert molded terminals and a sealed design lock out flux, solvent and other contaminants.

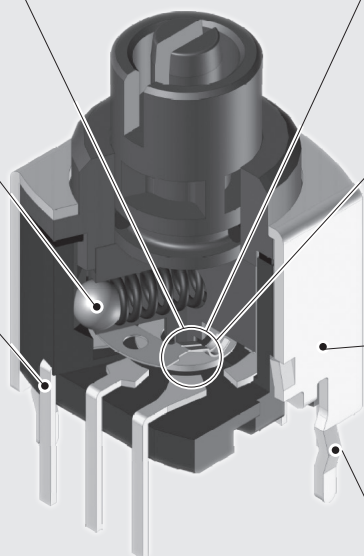

### ☞ Sliding Contact Mechanism

The switch contacts are gold plated and equipped with a sliding dual-contact mechanism for improved contact reliability.

### ☞ Improved Contact Reliability

The switch contacts feature a sealed design to lock out water, gas, foreign particles, or dust and to ensure high contact reliability and consistent quality.

### ☞ Enhanced Mounting Strength

Includes a bracket to enhance mounting strength on printed circuit boards.

### ☞ Antilifting Design

The bracket feet are crimped to ensure secure PC mounting and to prevent dislodging during soldering.

## General Specifications

General Specifications	
Electrical Capacity	0.4VA maximum @ 28V maximum (AC/DC) ( Applicable Range 0.1 mA ~ 0.1A @ 20mV ~ 28V )
Contact Resistance	100mΩ maximum (10mA @ 20mV)
Insulation Resistance	100MΩ minimum @ 500V DC
Dielectric Strength	500V AC for 1 minute minimum
Mechanical Life	30,000 minimum round-trip cycles
Electrical Life	10,000 minimum round-trip cycles
Operating Temperature Range	-25°C through +70°C (-13°F through +158°F)
Soldering	▶ Manual soldering: Profile A ▶ Wave Soldering: Profile A See Profile A in the supplementary section "Switch Guide".

## ▶ Actual Size

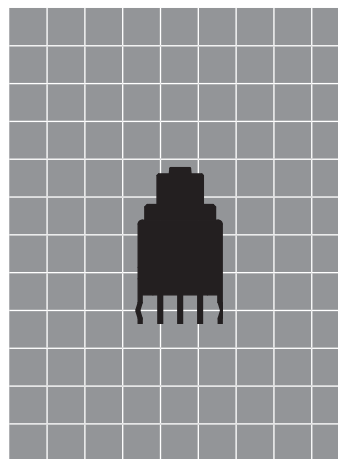

⚠ Each rated value/performance value is obtained through independent testing. Therefore, the same results are not guaranteed under complex conditions. Please refer to General Specifications page in General Catalog "Switch Guide" on specific models, ratings and ordering instructions.

## ▶ Applications

- Power Supply Control Equipment
- Measuring Equipment
- Medical Equipment
- Communication Equipment

## ► Switch Classification System

### Switch Body

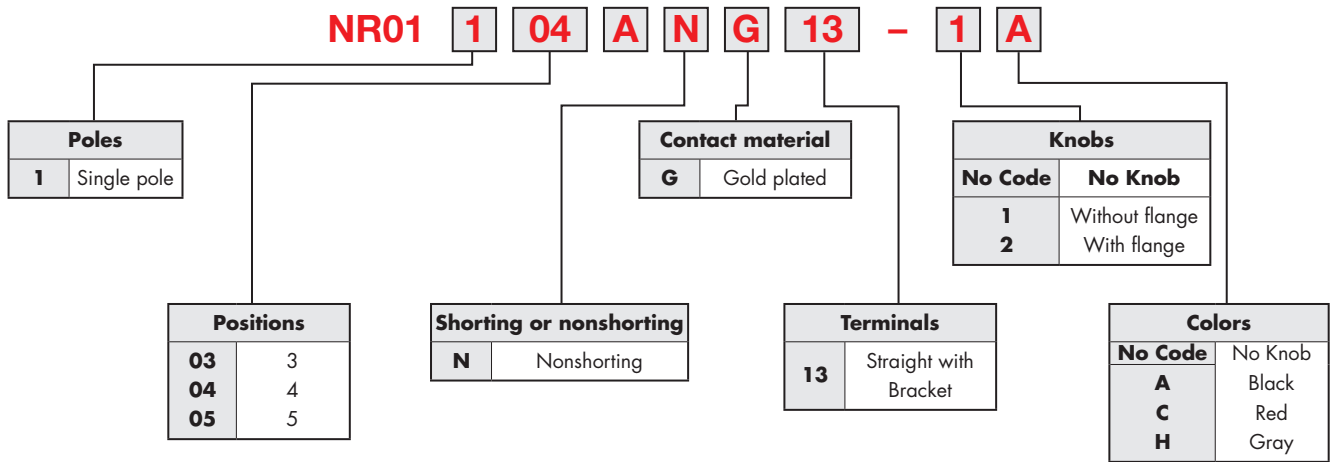

### Knob

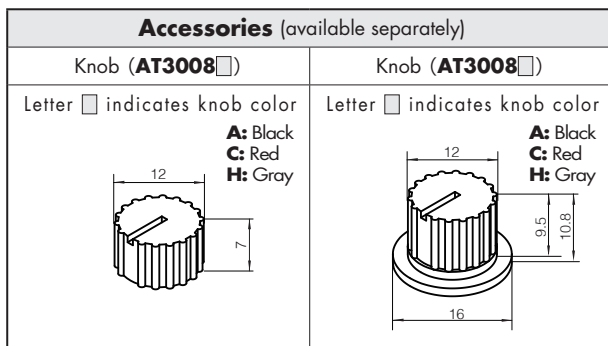
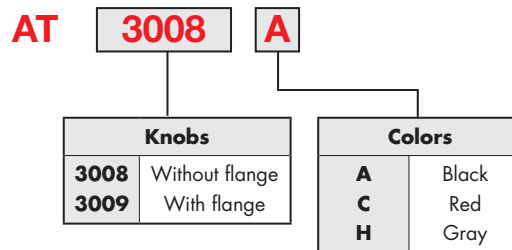

## ► Sales Date

July 3, 2017

## ▶ Typical Switch Dimensions

Model	Circuit & Position	Connected Position Number					
		I	II	III	IV	V	
NR01103ANG13	SP3T	C-2	C-3	C-4	—	—	(1) and (5) are support terminals
NR01104ANG13	SP4T	C-2	C-3	C-4	C-5	—	(1) is a support terminal
NR01105ANG13	SP5T	C-1	C-2	C-3	C-4	C-5	

### 45° Indexing SP3T PC Bracket

▶Knobs are available separately. ▶Terminal numbers are not marked on the switch body.

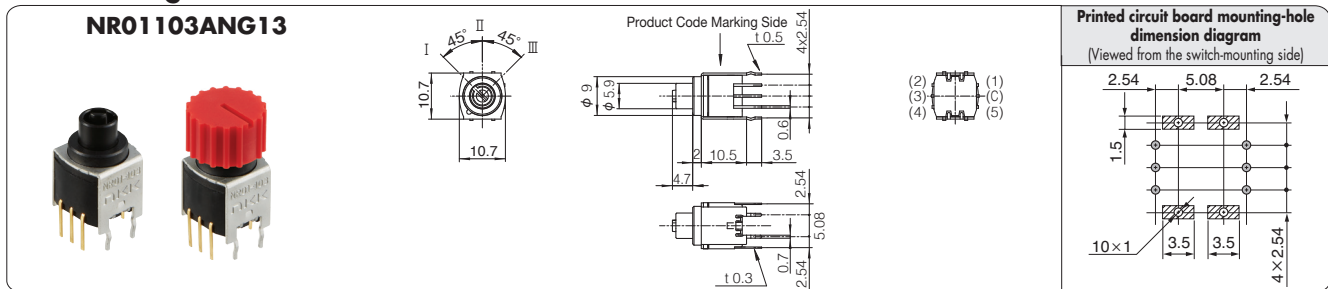

### 45° Indexing SP4T PC Bracket

▶Knobs are available separately. ▶Terminal numbers are not marked on the switch body.

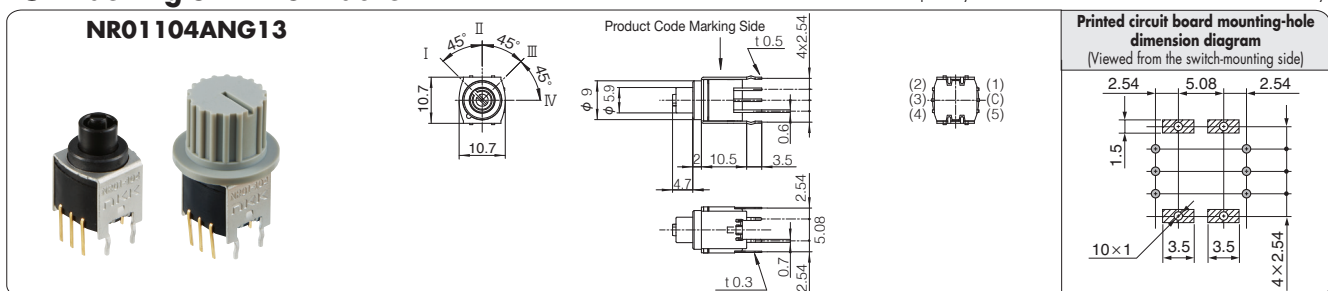

### 45° Indexing SP5T PC Bracket

▶Knobs are available separately. ▶Terminal numbers are not marked on the switch body.

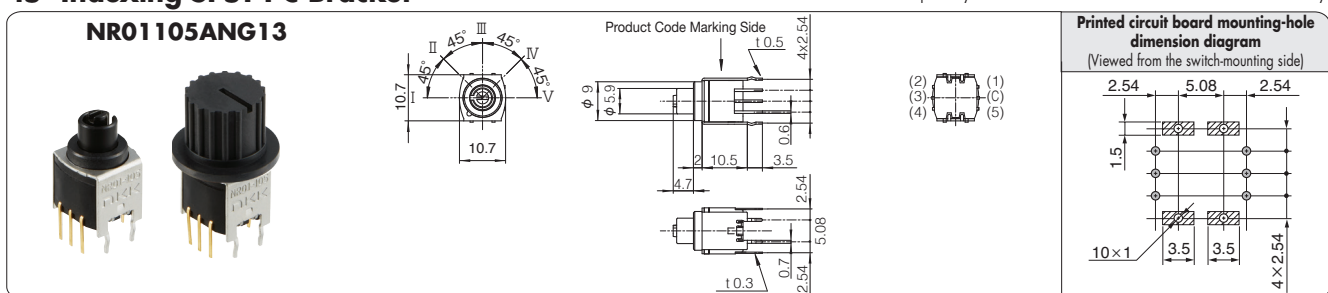

## ▶ Handling Instructions

### Knob Insertion

The knob is crimp-fitted onto the switch body and may become detached if tampered with or pulled forcefully.

To prevent the knob from detaching, use AT3009A/C/H and mount with the flange of the knob underneath the panel.

(See "Recommended panel mounting method.")

### Recommended panel mounting method

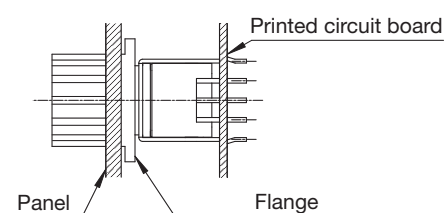

## Ideal for equipment requiring precise operation Compact but dependable

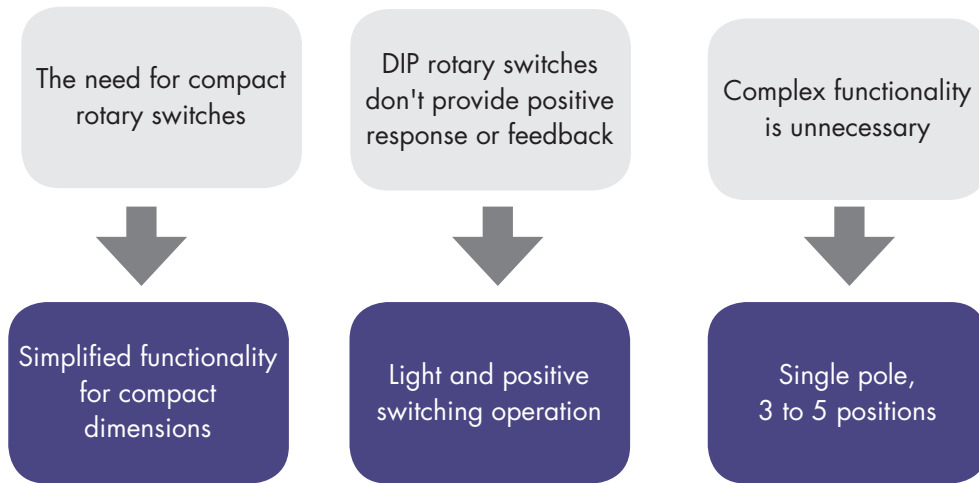

## Advantages

- Easy to solder and clean, thus reducing labor hours
- Increased mounting strength and durability due to the use of a bracket
- Minimized functions for ease of use
- Compact design, with a crisp actuation

## Typical Applications



**Function selector switch**

For example, selecting "F1", "F2", "F3", or "F4"

**Handy terminal**

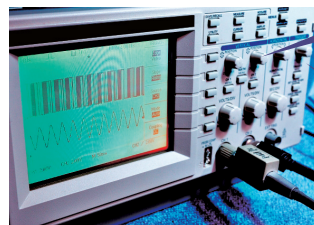

**Input selector switch**

For example, selecting "AC", "DC", or "GND"

**Signal waveform selector**

For example, selecting "CH1", "CH2", or "DUAL"

**Measuring equipment**

## Comparison of Circuit Board-mounted Rotary Switches

Type	NR01	MRB	MRA-□	FR01-K□
Circuit	1	1, 2	1, 2, 4	—
Terminals	3, 4, 5	2, 3	2 to 12	—
Electrical Capacity	0.4VA maximum @ 28V maximum AC/DC	0.4VA maximum @ 28V maximum AC/DC	250mA @ 125V AC	100mA @ 5V DC
Electrical Life	10,000 cycles minimum	10,000 cycles minimum	10,000 cycles minimum	10,000 detent cycles minimum
Operating Temperature Range	-25°C through +70°C (-13°F through +158°F)	-10°C through +70°C (14°F through +158°F)	-10°C through +70°C (14°F through +158°F)	-25°C through +85°C (-13°F through +185°F)
Dimensions	10.7 mm x 10.7 mm (.421" x .421")	14.5 mm x (15.74) mm (.571" x .620")	φ 16 mm (.630" Dia.)	10 mm x 10 mm (.394" x .394")
Fully Washable	OK	OK	OK	Not OK

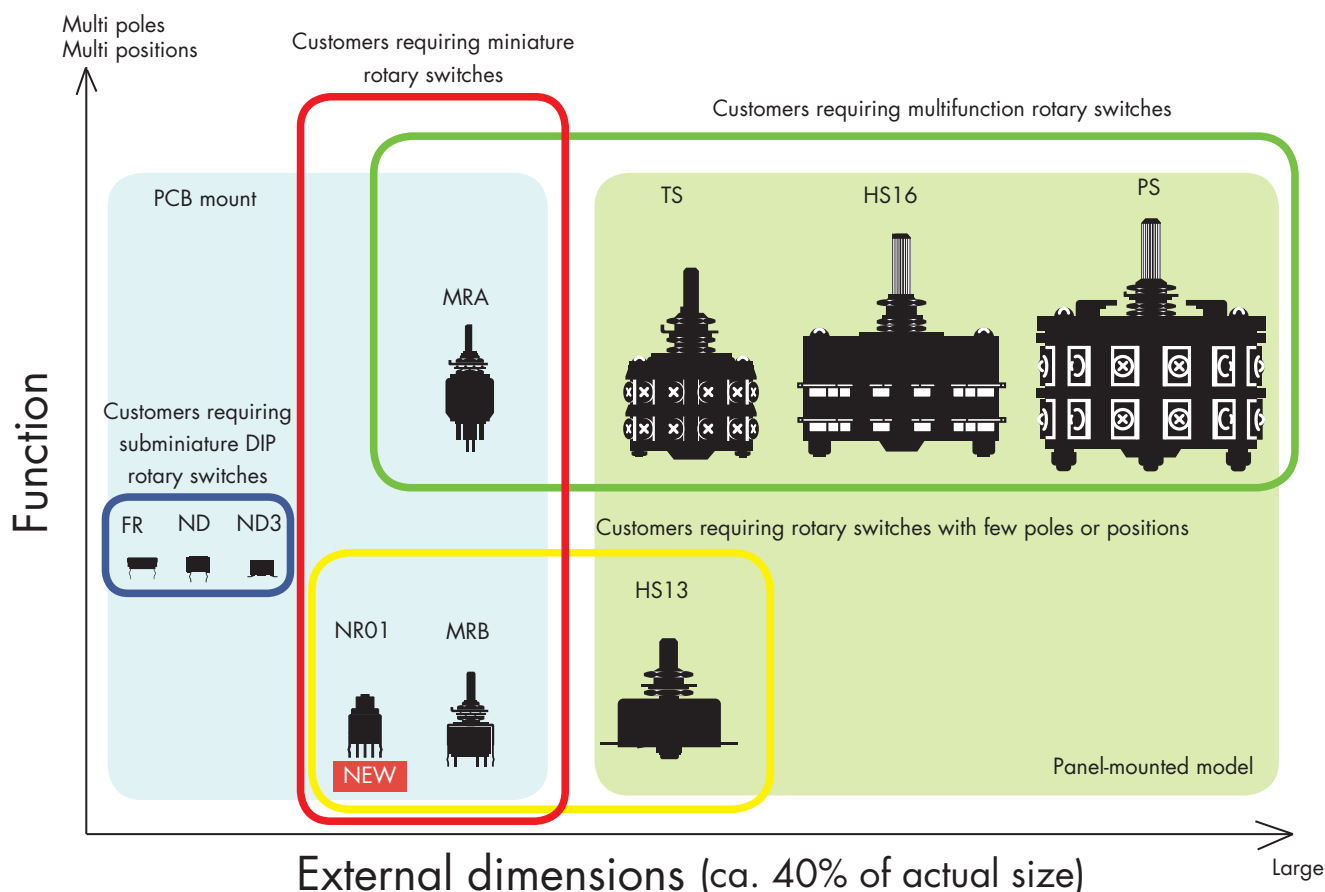

\* Specifications presented here are subject to change without notice. Check with our staff for the latest specifications.

**NKK SWITCHES CO., LTD.** <http://www.nkk.com> E-mail: [nkkswitches@nkkswitches.co.jp](mailto:nkkswitches@nkkswitches.co.jp)

715-1 Unane, Takatsu-ku, Kawasaki-shi, Kanagawa-ken 213-8553 Japan Tel: +81 44 813 8001 Fax: +81 44 813 8031