

Metal Switch Medium Stroke, Switching Voltage up to 250 VAC



See below:

### Approvals and Compliances

#### Description

- Switch with homogeneous surface illumination Assembly method: clip micro-switch into the saddle, secure switch using mounting nut
- Equipped with flat-pin plugs to permit fast connection

#### Unique Selling Proposition

- Attractive tactile feedback
- High quality materials
- Long life span
- Scratch-resistant biocompatible ceramic actuator

#### Characteristics

- Housing material: high-quality stainless steel, actuator material: highly durable ceramic
- Variety of design options regarding size, colour, illumination, connection or lettering
- Switching voltage from 30 VDC to 250 VAC, switching current from 0.1 A to 10 A
- IP-Protection: IP 67 from front side to contact area, Micro-Switch is available in versions IP 40 or IP 67
- for use in harsh environments (see technical data)

#### References

Alternative: double-pole switch: [MSM DP 22](#); [MSM DP 30](#)

Alternative: switch with latching function: [MSM LA CS 19](#); [MSM LA CS 22](#); [MSM LA 19](#); [MSM LA 22](#)

Alternative: switch with ring illumination: [MSM 16](#); [MSM 19](#); [MSM 22](#); [MSM 30](#)

Alternative: Other diameter [MSM CS 19](#); [MSM CS 22](#)

#### Weblinks

[html-datasheet](#), [General Product Information](#), [CAD-Drawings](#), [Product News](#), [Detailed request for product](#)

**Technical Data****Electrical Data**

Switching Function	N.O., N.C., N.O./N.C.
Number of Poles	1-pole
Supply Voltage	24 VDC Surface backlighting 2 kV MSM

**Micro Switch 5 A / 125 VAC or 3 A / 250 VAC, IP40**

Contact Material	Ag
Switching Voltage	max. 125 / 250 VAC
Switching Current	max. 5 / 3 A
Rated Switching Capacity	750 W
Lifetime	0.2 million actuations at Rated Switching Capacity
Contact Resistance	< 30 mΩ
Insulation Resistance	> 100 MΩ
Duration of Bounce	< 5 ms

**Micro Switch 0,1 A / 30 VDC, IP40**

Contact Material	Au
Switching Voltage	max. 30 VDC
Switching Current	max. 0.1 A
Rated Switching Capacity	3 W
Lifetime	0.2 million actuations at Rated Switching Capacity
Contact Resistance	< 50 mΩ
Insulation Resistance	> 100 MΩ
Duration of Bounce	< 5 ms

**Micro Switch for Electrical Rating 10 A / 250 VAC (Protection Class IP40)**

Contact Material	Ag
Switching Voltage	max. 250 VAC
Switching Current	max. 10 A
Rated Switching Capacity	2500 W
Lifetime	0.05 million actuations at Rated Switching Capacity
Contact Resistance	< 30 mΩ
Insulation Resistance	> 100 MΩ
Duration of Bounce	< 5 ms

**Micro Switch 6 A / 250 VAC, IP67**

Switching Voltage	max. 250 VAC
Switching Current	max. 5
Rated Switching Capacity	1250 W
Lifetime	0.05 million actuations at Rated Switching Capacity

**Micro Switch 0,1 A / 250 VAC, IP67 - on request**

Switching Voltage	max. 250 VAC
Switching Current	max. 0.1
Rated Switching Capacity	25 W
Lifetime	0.05 million actuations at Rated Switching Capacity

**Micro Switch 10 A / 250 VAC, IP67 - on request**

Switching Voltage	max. 250 VAC
Switching Current	max. 10 A
Rated Switching Capacity	2500 W
Lifetime	0.01 million actuations at Rated Switching Capacity

**Mechanical Data**

Actuating Force	4.5 N
Actuating Travel	1.0 mm
Lifetime	1.5 million actuations
Shock Protection	IK 07
Tightening Torque Plastic Nut	max. 2 Nm
Tightening Torque Stainless Steel Nut	max. 10 Nm

**Climatical Data**

Operating Temperature	-25 to +85 °C
Storage Temperature	-25 to +85 °C
Protection Class	IP 67
Switching Unit	IP 40 IP 67 optional
Salt Spray Test (acc. to DIN 50021-SS)	24 h / 48 h / 96 h Residence Time

**Material**









Housings	Stainless Steel
Actuator	Ceramic (Zirconium Dioxide)
Seal Ring	NBR70
Switcher Collet	PA

**Approvals and Compliances**

Detailed information on product approvals, code requirements, usage instructions and detailed test conditions can be looked up in [Details about Approvals](#)



**Approvals**

Approval Reference Type: MSM 16

Approval Logo	Certification Body	Description
		Low Voltage Directive 2014/35/EU compliant following certificate numbers apply to micro switch
		VDE / ENEC Certificate Number (Omron): 40008425, 129246, 125256
	UL	UL / CSA File Number (Omron): E41515
		VDE / ENEC Certificate Number (Marquardt): 097550
	UL	UL / CSA File Number (Marquardt): E41791
	KEMA	KEMA / ENEC File Number (Cherry): 2089323.01
	UL	UL / CSA File Number (Cherry): E23301
	CQC	CQC File Number (Marquardt): CQC13005090991

### Product standards

Product standards that are referenced

Organization	Design	Standard	Description
	Designed according to	DIN EN 61058-1	Switches for appliances. Part 1. General requirements
	Designed according to	UL 1054	UL standard for safety special-use switches

### Application standards

Application standards where the product can be used

Organization	Design	Standard	Description
	Designed for applications acc.	IEC/UL 60950	IEC 60950-1 includes the basic requirements for the safety of information technology equipment.

### Compliances

The product complies with following Guide Lines

Identification	Details	Initiator	Description
	RoHS	SCHURTER AG	EU Directive RoHS 2011/65/EU
	REACH	SCHURTER AG	On 1 June 2007, Regulation (EC) No 1907/2006 on the Registration, Evaluation, Authorization and Restriction of Chemicals 1 (abbreviated as "REACH") entered into force.

## Dimension [mm]

MSM CS

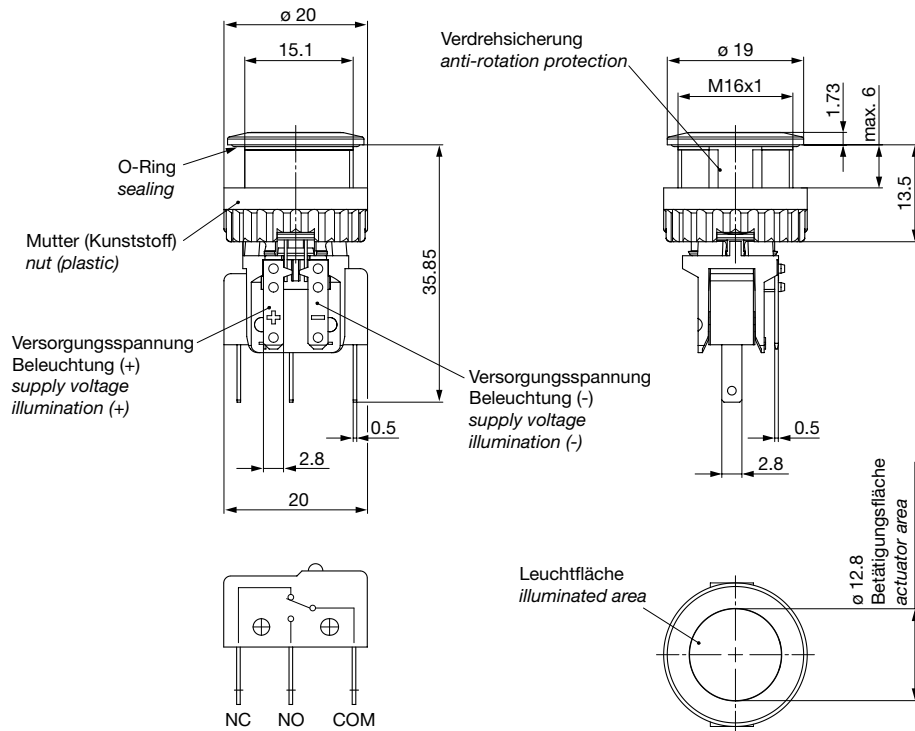

## Tolerance Range

Actuator Tolerance Range

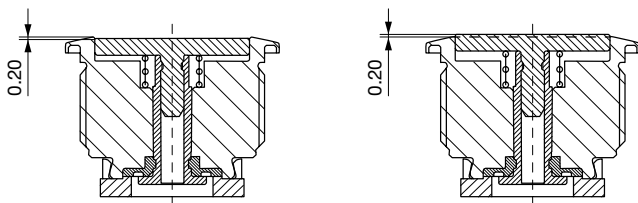

The mounting tolerance range of the actuator varies from 0.2 mm projection length and 0.2 mm short length to the housing edge. The slanting position of the actuator can range within this tolerance.

## Dimension

MSM 16 CS

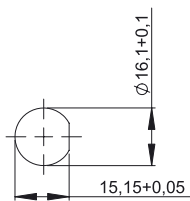

Drilling diagram

**Assembly Instructions**

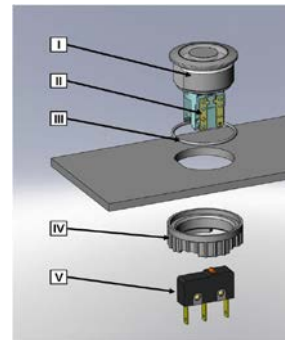
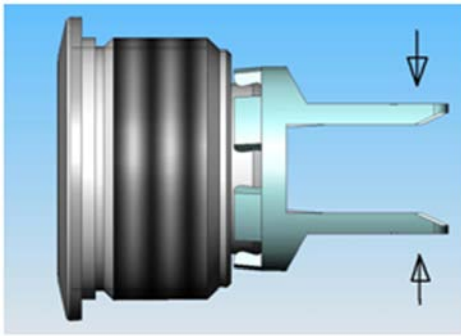

During assembly, the protruding bars of the holder should not be pressed together.

- I Housing
- II Flat Pin Terminal (Illumination)
- III Gasket
- IV Nut (Nut type see Dimensions)
- V Module Switching Contact

Installation Instruction:

- 1.) Place the gasket accurately on the actuator housing. Then mount the actuator housing assembly into the panel.
- 2.) Tighten the screw nut according to the torque instructions.
- 3.) Clasp the module switching contact into the micro switch holder of the actuator housing.

Installation information:

- 1.) The power supply and the configuration of the flat pin terminals have to be installed correctly for the illumination and micro switch function.
- 2.) Insulate the terminals as required. Fully insulated plug-in sleeves are recommended.
- 3.) Installation instructions according to VDE-standard DIN VDE 0100-100 or alternatively IEC 60354 standard.

**Diagrams**

MSM CS

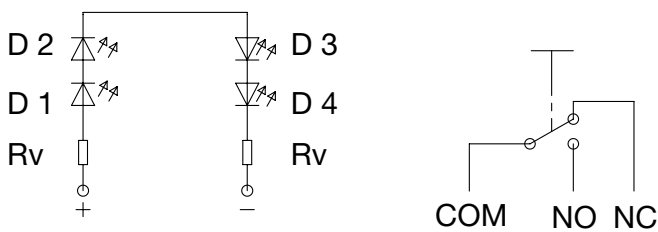

**Lettering**





The last three digits in the order number define the lettering:

000	No Lettering
001-074	Standard Lettering
101-	Customized Lettering

**Lettering Colour of Laser Lettering**

Material	Lettering Colour
Ceramic	black Filled letters

## Order Index Lettering

Laser Marking			
001 = <b>A</b>	021 = <b>U</b>	041 = ÷	061 = <b>EIN</b>
002 = <b>B</b>	022 = <b>V</b>	042 = *	062 = <b>AUS</b>
003 = <b>C</b>	023 = <b>W</b>	043 = =	063 = <b>AUF</b>
004 = <b>D</b>	024 = <b>X</b>	044 = #	064 = <b>AB</b>
005 = <b>E</b>	025 = <b>Y</b>	045 = ↔	065 = <b>ON</b>
006 = <b>F</b>	026 = <b>Z</b>	046 = †	066 = <b>OFF</b>
007 = <b>G</b>	027 = <b>0</b>	047 = →	067 = <b>UP</b>
008 = <b>H</b>	028 = <b>1</b>	048 = ←	068 = <b>DOWN</b>
009 = <b>I</b>	029 = <b>2</b>	049 = ↓	069 = <b>HIGH</b>
010 = <b>J</b>	030 = <b>3</b>	050 = ↑	070 = <b>LOW</b>
011 = <b>K</b>	031 = <b>4</b>	051 = %	071 = <b>ON/OFF</b>
012 = <b>L</b>	032 = <b>5</b>	052 = √	072 = <b>START</b>
013 = <b>M</b>	033 = <b>6</b>	053 = <b>CTRL</b>	073 = <b>RESET</b>
014 = <b>N</b>	034 = <b>7</b>	054 = <b>RETURN</b>	074 = 
015 = <b>O</b>	035 = <b>8</b>	055 = <b>SHIFT</b>	075 = 
016 = <b>P</b>	036 = <b>9</b>	056 = <b>LOCK</b>	076 = 
017 = <b>Q</b>	037 = <b>+</b>	057 = <b>STOP</b>	077 = 
018 = <b>R</b>	038 = <b>-</b>	058 = <b>ENTER</b>	
019 = <b>S</b>	039 = <b>.</b>	059 = <b>BACK</b>	
020 = <b>T</b>	040 = <b>x</b>	060 = <b>LINE</b>	

## All Variants

IP Switching Unit	Switching Current [A]	Switching Voltage [VAC/VDC]	Illumination, LED	Housing Material, Torsion Protection	Actuator Material, Torsion Protection	Config. Code	Order Number
IP 40	100 mA	30 VDC	Backlighted, red, 24 VDC	Stainless Steel ,yes	Stainless Steel ,yes	MSM 16 CS red	3-102-633
IP 40	10 A	250 VAC	Backlighted, red, 24 VDC	Stainless Steel ,yes	Stainless Steel ,yes	MSM 16 CS red	3-102-635
IP 40	100 mA	30 VDC	Backlighted, green, 24 VDC	Stainless Steel ,yes	Stainless Steel ,yes	MSM 16 CS green	3-102-636
IP 40	10 A	250 VAC	Backlighted, green, 24 VDC	Stainless Steel ,yes	Stainless Steel ,yes	MSM 16 CS green	3-102-639
IP 40	100 mA	30 VDC	Backlighted, blue, 24 VDC	Stainless Steel ,yes	Stainless Steel ,yes	MSM 16 CS blue	3-102-640
IP 40	10 A	250 VAC	Backlighted, blue, 24 VDC	Stainless Steel ,yes	Stainless Steel ,yes	MSM 16 CS blue	3-102-642
IP 40	100 mA	30 VDC	Backlighted, yellow, 24 VDC	Stainless Steel ,yes	Stainless Steel ,yes	MSM 16 CS yellow	3-102-643
IP 40	10 A	250 VAC	Backlighted, yellow, 24 VDC	Stainless Steel ,yes	Stainless Steel ,yes	MSM 16 CS yellow	3-102-645
IP 40	100 mA	30 VDC	Backlighted, white, 24 VDC	Stainless Steel ,yes	Stainless Steel ,yes	MSM 16 CS white	3-102-646
IP 40	10 A	250 VAC	Backlighted, white, 24 VDC	Stainless Steel ,yes	Stainless Steel ,yes	MSM 16 CS white	3-102-648

Legend:

Type:

MSMCS = Ceramic Surface

Al = BL = Full Surface Backlighting: Lettering possible (see Lettering, last 3 digits)

IP-Protection: IP 67 from front side to contact area, Micro-Switch is available in versions IP 40 or IP 67, see Technical Data Micro-Switch

Variants with 6 A micro switch have IP67

The MOQ for standard laser lettering on standard variants is 10 pieces.

Customer-specific versions available on request.

Special materials for use in salt and chlorinated environment on request.

The nut with gasket and micro switch are enclosed in the box.

 Most Popular.Availability for all products can be searched real-time: <https://www.schurter.com/en/Stock-Check/Stock-Check-SCHURTER>**Packaging unit** 10 in box with insert or packed in air cushion bags



- Actuating elements in ESD safe packaging
- Screw nuts and sealing rings in a bag (enclosed in the box)

## Accessories

### Description



Installation Wrench MSM 16  
Installation Wrench



Power Supply  
Power Supply IP42 for LED- and Illumination applications indoor 90~264 VAC => 24 VDC 0.34 A 8 W