

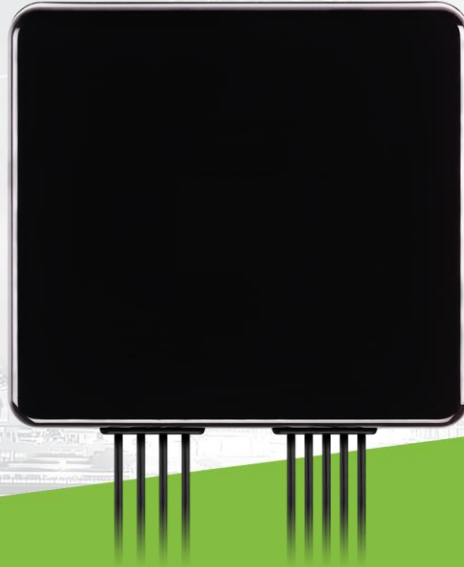

# TAOGLAS®



# Datasheet

## 9-in-1 Guardian

**Part No:**  
MA990.A.001

### **Description:**

Guardian 9-in-1 Combination Adhesive Mount Antenna  
1\*Active Dual-band GNSS, 8\*5G/4G MIMO

### **Features:**

Low-profile IP67 Rated Housing  
8\*5G/4G MIMO  
1\*GNSS – GPS/GLONASS/BeiDou/Galileo L1/L2  
Cables: GNSS 1m of RG-174, 5G/4G 1m of TGC-1.5DS  
Connectors: SMA Male Straight  
Dimensions: 148 x 134 x 20.5mm  
CE Certified  
RoHS & Reach Compliant

1. Introduction	3
2. Specifications	5
3. Antenna Characteristics	10
4. Active Antenna Characteristics	23
5. Radiation Patterns	27
6. Mechanical Drawing	62
7. Packaging	63
8. Application Note	64
<hr/>	
Changelog	80

Taoglas makes no warranties based on the accuracy or completeness of the contents of this document and reserves the right to make changes to specifications and product descriptions at any time without notice. Taoglas reserves all rights to this document and the information contained herein. Reproduction, use or disclosure to third parties without express permission is strictly prohibited.



# 1. Introduction



The Taoglas MA990 Guardian has been designed to be the smallest 9-in-1 combination antenna in the world. The MA990 Guardian is also the worlds first 9-in-1 antenna with dual-band GNSS and high performance 5G/4G allowing it to be compatible with the next generation of modules and routers. The MA990 combines all 9 antenna elements in one low-profile heavy-duty, IP67 rated waterproof, adhesive mount external enclosure.

It comes with 1\* Active dual-band GPS/GLONASS/BeiDou/Galileo L1/L2 coverage, 8\* 5G/4G Cellular MIMO. The MA990 has been designed as a low profile solution for IoT and Automotive applications where space is at a premium allowing it to be installed in the headliners of vehicles or on the back window of a vehicle.

This is an ideal external combination antenna solution that is used where drilling a hole through the roof of a vehicle or a metal panel for an external antenna is not feasible or desired and can be covertly installed via the adhesive pad supplied with the antenna.

Typical applications include:

- Passenger Bus / Rail / Air Applications.
- Automotive and Heavy Equipment Vehicle Tracking and Telematics
- HD Video over 5G/4G
- First Responder and Emergency Services
- 

The MA990 Guardian has been specifically designed to hit certain 5G bands required for modules, for example MIMO 4 and MIMO are tuned from 600-6000MHz while MIMO 3 and MIMO 6 are tuned from 3000-6000MHz to cover high band 5G and C-band/CBRS applications. This data is shown below in the performance table, and it is recommended to use the suitable connections for your required frequency bands by reviewing this table before connecting the antenna to your device.

Taoglas also provides services to ensure optimum overall performance for your entire system by working closely with the customer to design in the best antenna and potential additional components for your system.

5G/4G applications demand high-speed data uplink and downlink. High efficiency and high gain MIMO antennas are necessary to achieve the required signal to noise ratio and throughput required to solve these challenges. Taoglas also takes care to ensure high isolation between the MIMO antennas to prevent self-interference. Low loss cables are used to keep efficiency high over longer cable lengths. In contrast, smaller MIMO antennas with poorer quality thin cables will have reduced efficiency and isolation, which would lead to a large drop in system throughput, increased incidences of signal drops, and may indeed not make a system connection at all.

Cable type and length, and connector types are fully customizable and the Guardian can also be customized for any variation of antennas below 9-in-1 and the addition of Wi-Fi/Single Band GNSS is also possible. Contact your regional Taoglas customer support team for more information.

## 2. Specifications

GNSS Frequency Bands Covered						
GPS	L1	L2	L5			
	■	■	□			
GLONASS	G1	G2	G3			
	■	□	■			
Galileo	E1	E5a	E5b	E6		
	■	□	■	□		
BeiDou	B1	B2a	B2b	B3		
	■	□	■	□		
QZSS (Regional)	L1	L2C	L5	L6		
	■	■	□	□		
IRNSS (Regional)	L5					
	□					
SBAS	L1/E1/B1	L5/B2a/E5a	G1	G2	G3	
	■	□	■	□	■	

■ GNSS Frequency Bands Covered. □ GNSS Frequency Bands Not Covered.

\*SBAS systems: WASS(L1/L5), EGNOS(E1/E5a), SDCM(G1/G2/G3), SNAS(B1,B2a), GAGAN(L1/L5), QZSS(L1/L5), KAZZ(L1/L5).

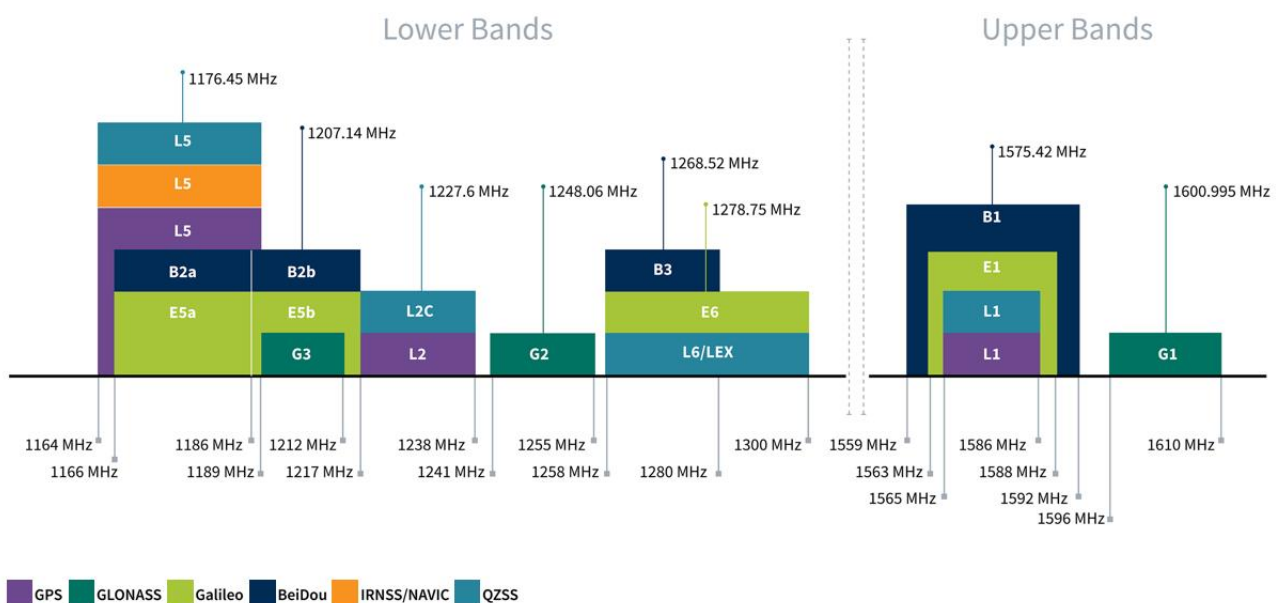

### GNSS Bands and Constellations

GPS L1 & L2 Antenna						
Frequency	GPS_L2 1207-1239	GLONASS_G2 1241-1248	BeiDou_B1 1559-1563	Galileo_E1 1563-1587	GPS_L1 1564-1587	GLONASS 1593-1610
Average Gain (dB)	-2	-3.2	-4.4	-1.6	-1.6	-4.4
Efficiency (%)	63.2	47.5	36.3	69.1	69.1	36.1
Peak Gain (dBi)	4.2	3.2	0.9	3.7	3.7	0.8
Axial Ratio at Zenith	13.7	22.2	17.4	8.6	6.6	19.1
Impedance	50 Ω					
Polarization	RHCP					

LNA and Filter Electrical Properties	
3V (Typ.)	
LNA Gain	L2 19.6
	L1 22.6
Noise Figure	L1 3.8
	L2 2.4
Current Consumption	16.8mA
Outer Band Attenuation (dB)	30 @ Fc +/-100MHz 40 @ Fc +/-200MHz
Output Impedance	50 Ohm
Return loss (dB)	<-10 dB
Input Voltage (V)	+ 1.8 to 5.5

5G/4G MIMO								
Band	Frequency (MHz)		Efficiency (%)	Average Gain (dB)	Peak Gain (dBi)	VSWR	Impedance	Polarization
5G NR/4G Band 5,8,12,13,14,17,18,20,26,27,28, 29,71	617~960	MIMO 1	N/A	N/A	N/A	3 Max	50Ω	Linear
		MIMO 2	N/A	N/A	N/A			
		MIMO 3	N/A	N/A	N/A			
		MIMO 4	43.6	-3.6	1.5			
		MIMO 5	43.8	-3.6	2.1			
		MIMO 6	N/A	N/A	N/A			
		MIMO 7	N/A	N/A	N/A			
		MIMO 8	N/A	N/A	N/A			
5G NR/4G Band 21,32,74,75,76	1427~1518	MIMO 1	N/A	N/A	N/A			
		MIMO 2	36.2	-4.4	2.2			
		MIMO 3	N/A	N/A	N/A			
		MIMO 4	37.4	-4.3	-0.1			
		MIMO 5	41.8	-3.8	0.1			
		MIMO 6	N/A	N/A	N/A			
		MIMO 7	39	-4.1	1.6			
		MIMO 8	N/A	N/A	N/A			

<b>4G/3G</b> Band 1,2,3,4,9,23,25,35,39,66	<b>1710~2200</b>	MIMO 1	53.2	-2.7	4			
		MIMO 2	53	-2.8	2.2			
		MIMO 3	N/A	N/A	N/A			
		MIMO 4	45.7	-3.4	3.5			
		MIMO 5	51.4	-2.9	3.25			
		MIMO 6	N/A	N/A	N/A			
		MIMO 7	39	-2.8	2.4			
		MIMO 8	52.7	-2.8	3.6			
<b>4G/3G</b> Band 7,30,38,40,41	<b>2390~2690</b>	MIMO 1	49	-3.1	3.3			
		MIMO 2	48	-3.2	1.9			
		MIMO 3	N/A	N/A	N/A			
		MIMO 4	47	-3.3	3.3			
		MIMO 5	44.5	-3.5	2.6			
		MIMO 6	N/A	N/A	N/A			
		MIMO 7	45	-3.5	2.8			
		MIMO 8	47.1	-3.3	4.5			
<b>5GNR/4G</b> Band 22,42,43,48,77,78,79	<b>3300~5000</b>	MIMO 1	51.5	-2.9	5.4			
		MIMO 2	N/A	N/A	N/A			
		MIMO 3	41	-3.9	4			
		MIMO 4	45.2	-3.5	2.9			
		MIMO 5	47.7	-3.2	2.5			
		MIMO 6	38	-4.2	4.2			
		MIMO 7	N/A	N/A	N/A			
		MIMO 8	52	-2.8	5.1			
<b>LTE5200/ Wi-Fi 5800</b>	<b>5150~5925</b>	MIMO 1	50.1	-2.9	5.2	3 Max	50Ω	Linear
		MIMO 2	N/A	N/A	N/A			
		MIMO 3	54	-2.7	5.3			
		MIMO 4	45	-3.5	7.1			
		MIMO 5	42	-3.8	6.6			
		MIMO 6	46.3	-3.3	4.2			
		MIMO 7	N/A	N/A	N/A			
		MIMO 8	51.5	-2.9	4.8			

<b>Mechanical</b>	
<b>Height</b>	20.5mm
<b>Planner Dimension</b>	146 x 134mm
<b>Housing Material</b>	ASA
<b>Adhesive</b>	CR4305 + 3M 9448HK
<b>Cable</b>	1m TGC-1.5DS for 5G/4G – Fully Customizable 1m RG174 for GNSS – Fully Customizable
<b>Connector</b>	5G/4G: SMA Male Straight – Fully Customizable GNSS: SMA Male Straight – Fully Customizable
<b>Weight</b>	800g
<b>Environmental</b>	
<b>Protection</b>	IP67
<b>Temperature Range</b>	-40°C to 85°C
<b>Humidity</b>	Non-condensing 65°C 95% RH



5G/4G Bands						
Band Number	5G NR / FR1 / LTE / LTE-Advanced / WCDMA / HSPA / HSPA+ / TD-SCDMA					
	Uplink	Downlink	Covered (4G/5G-1&8)	Covered (4G/5G-2&7)	Covered (4G/5G-3&6)	Covered (4G/5G-4&5)
1	UL: 1920 to 1980	DL: 2110 to 2170	✓	✓	✗	✓
2	UL: 1850 to 1910	DL: 1930 to 1990	✓	✓	✗	✓
3	UL: 1710 to 1785	DL: 1805 to 1880	✓	✓	✗	✓
4	UL: 1710 to 1755	DL: 2110 to 2155	✓	✓	✗	✓
5	UL: 824 to 849	DL: 869 to 894	✗	✗	✗	✓
7	UL: 2500 to 2570	DL: 2620 to 2690	✓	✓	✓	✓
8	UL: 880 to 915	DL: 925 to 960	✗	✗	✗	✓
9	UL: 1749.9 to 1784.9	DL: 1844.9 to 1879.9	✓	✓	✗	✓
11	UL: 1427.9 to 1447.9	DL: 1475.9 to 1495.9	✓	✓	✗	✓
12	UL: 699 to 716	DL: 729 to 746	✗	✗	✗	✓
13	UL: 777 to 787	DL: 746 to 756	✗	✗	✗	✓
14	UL: 788 to 798	DL: 758 to 768	✗	✗	✗	✓
17	UL: 704 to 716	DL: 734 to 746	✗	✗	✗	✓
18	UL: 815 to 830	DL: 860 to 875	✗	✗	✗	✓
19	UL: 830 to 845	DL: 875 to 890	✗	✗	✗	✓
20	UL: 832 to 862	DL: 791 to 821	✗	✗	✗	✓
21	UL: 1447.9 to 1462.9	DL: 1495.9 to 1510.9	✓	✓	✗	✓
22	UL: 3410 to 3490	DL: 3510 to 3590	✓	✓	✓	✓
23	UL: 2000 to 2020	DL: 2180 to 2200	✓	✓	✗	✓
24	UL: 1625.5 to 1660.5	DL: 1525 to 1559	✗	✓	✗	✓
25	UL: 1850 to 1915	DL: 1930 to 1995	✓	✓	✗	✓
26	UL: 814 to 849	DL: 859 to 894	✗	✗	✗	✓
27	UL: 807 to 824	DL: 852 to 869	✗	✗	✗	✓
28	UL: 703 to 748	DL: 758 to 803	✗	✗	✗	✓
29	UL: -	DL: 717 to 728	✗	✗	✗	✓
30	UL: 2305 to 2315	DL: 2350 to 2360	✓	✓	✗	✓
31	UL: 452.5 to 457.5	DL: 462.5 to 467.5	✗	✗	✗	✗
32	UL: -	DL: 1452 - 1496	✗	✓	✗	✓
35	1850 to 1910		✓	✓	✗	✓
38	2570 to 2620		✓	✓	✗	✓
39	1880 to 1920		✓	✓	✗	✓
40	2300 to 2400		✓	✓	✗	✓
41	2496 to 2690		✓	✓	✗	✓
42	3400 to 3600		✓	✗	✓	✓
43	3600 to 3800		✓	✗	✓	✓
48	3550 to 3700		✓	✗	✓	✓
66	UL: 1710-1780	DL: 2110-2200	✓	✓	✗	✓
71	617 to 698		✗	✗	✗	✓
74/75/76	1427 to 1518		✗	✓	✗	✓
77/78/79	3300 to 3800		✓	✓	✓	✓
WiFi 5800	5150 to 5925		✓	✓	✓	✓

### 3. Antenna Characteristics

#### 3.1 Return Loss - GNSS

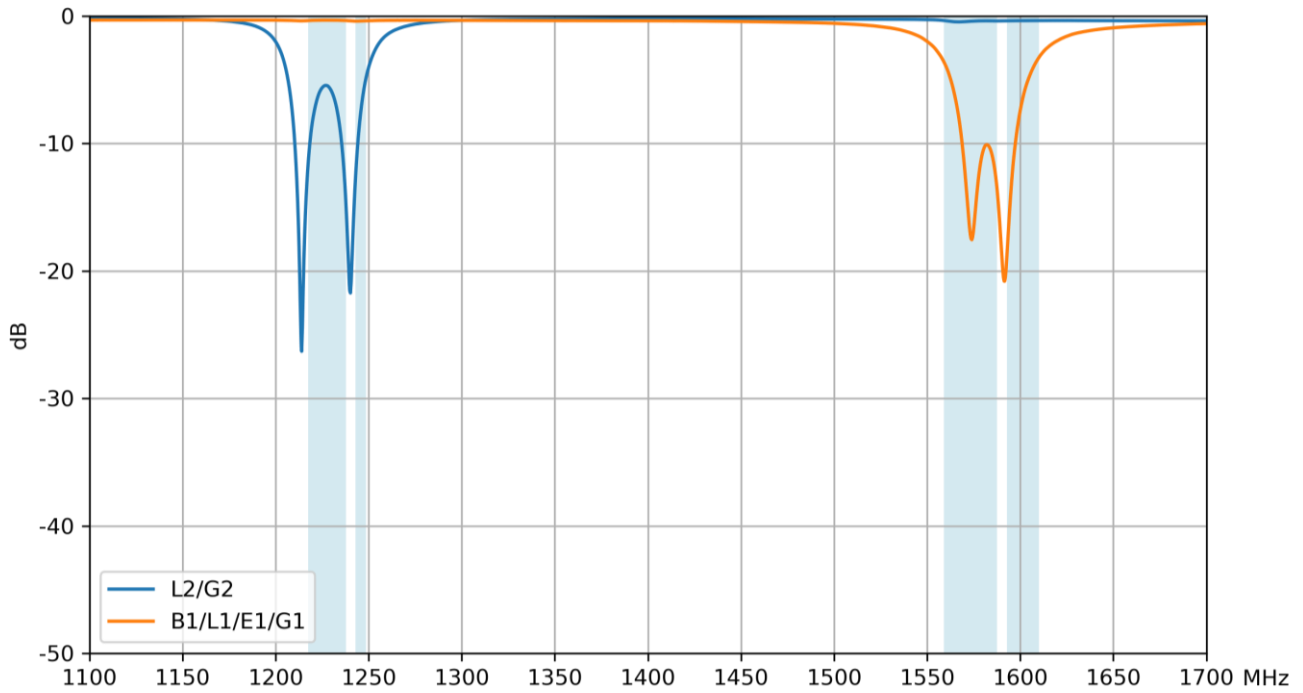

#### 3.2 VSWR – GNSS

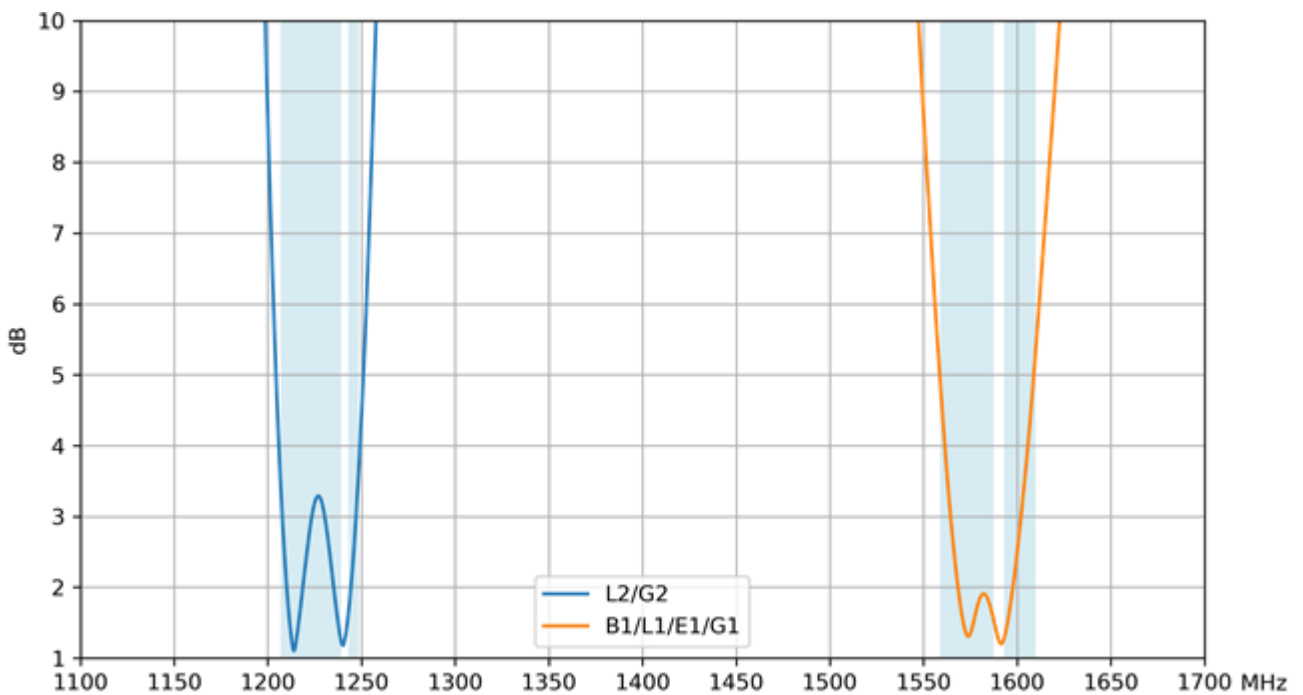

### 3.3 Efficiency – GNSS

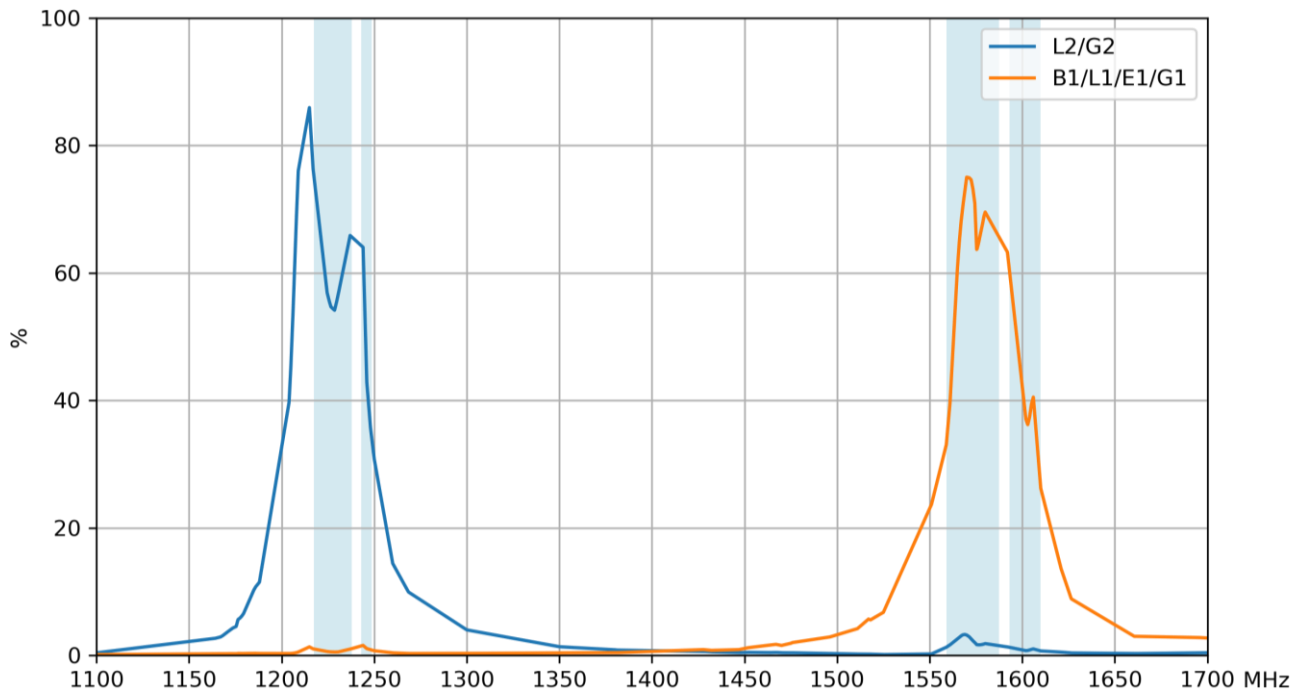

### 3.4 Average Gain - GNSS

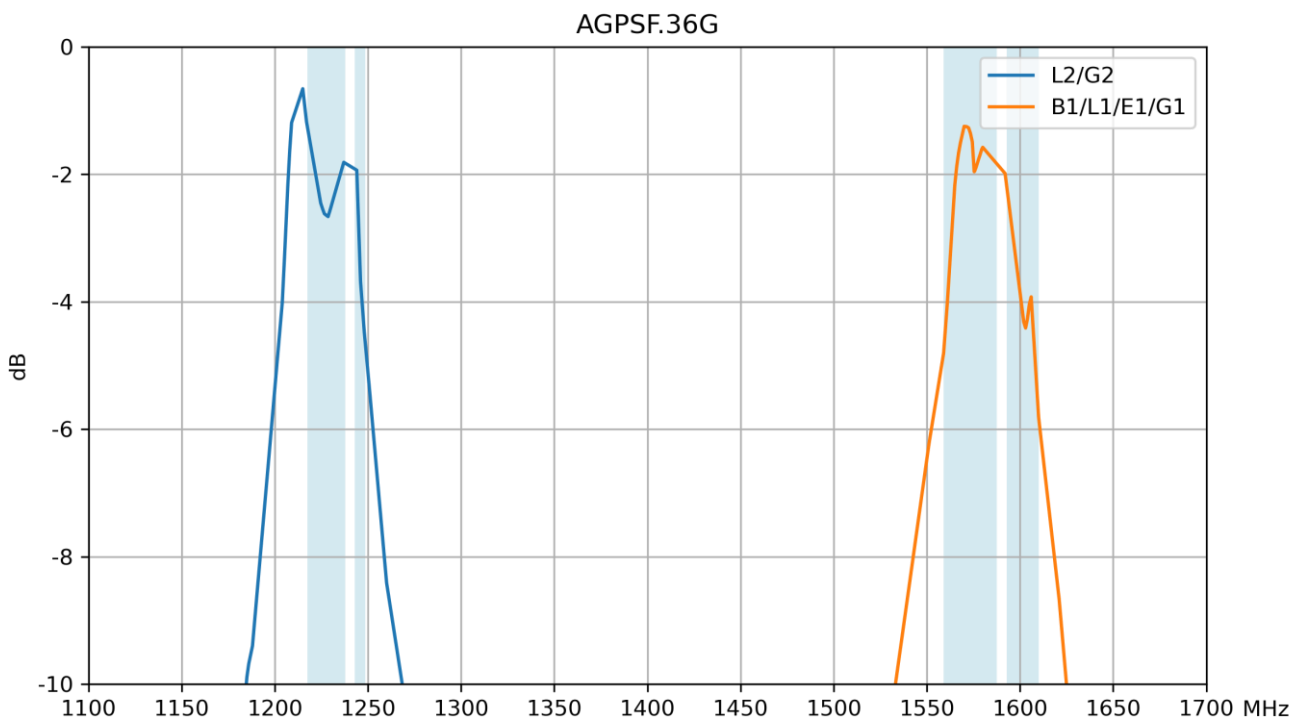

### 3.5 Peak Gain – GNSS

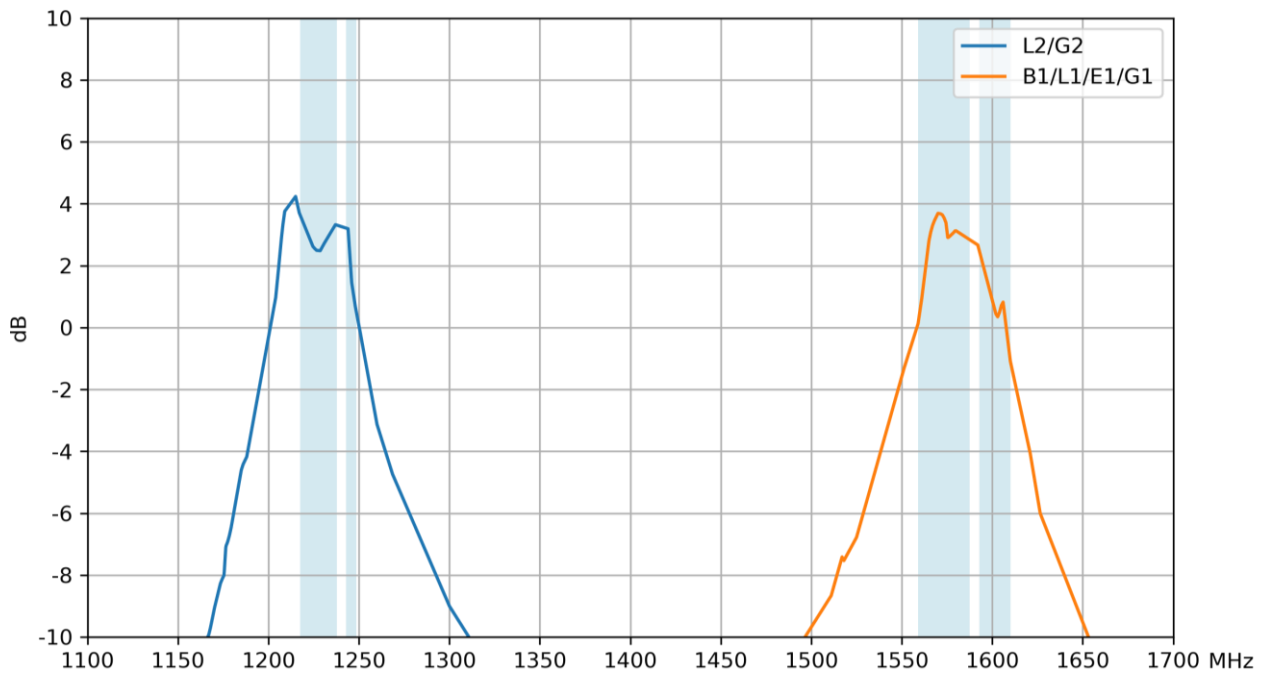

### 3.6 Axial Ratio – GNSS

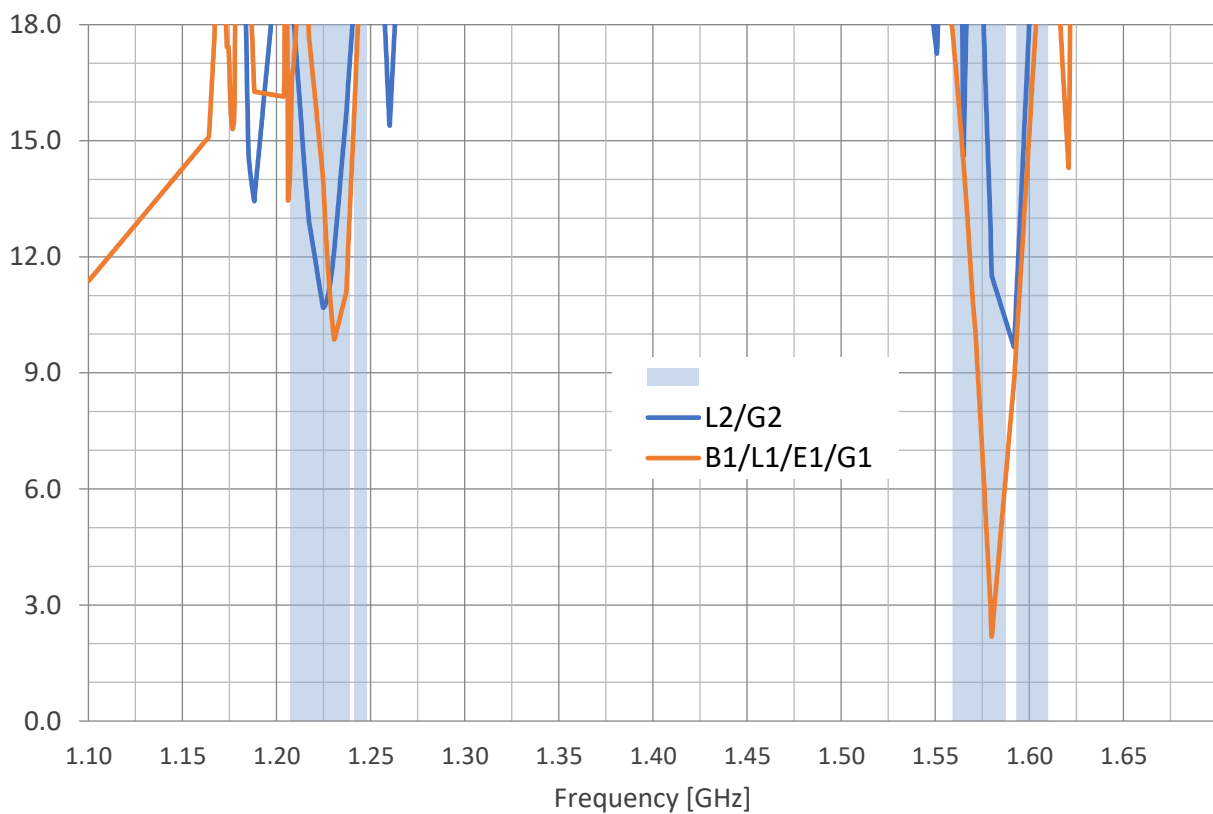

### 3.7 Return Loss - 5G/4G 1 & 8

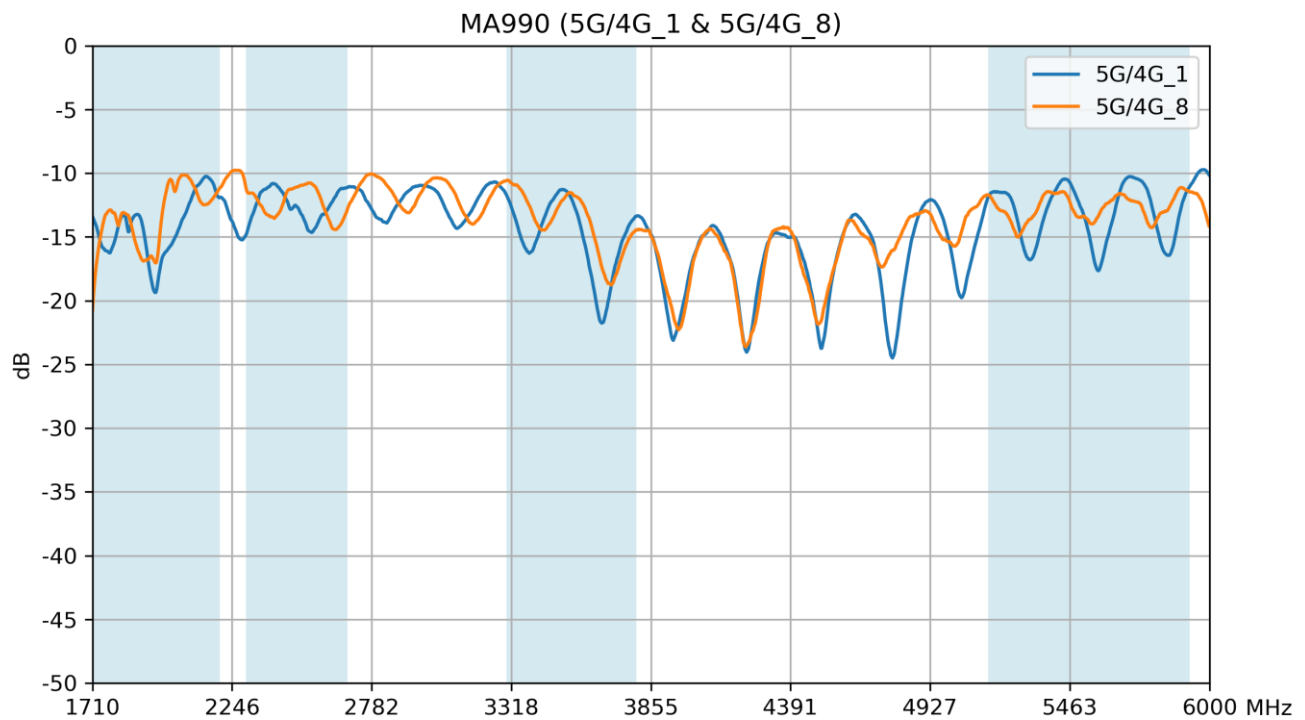

### 3.8 Return Loss - 5G/4G 2 & 7

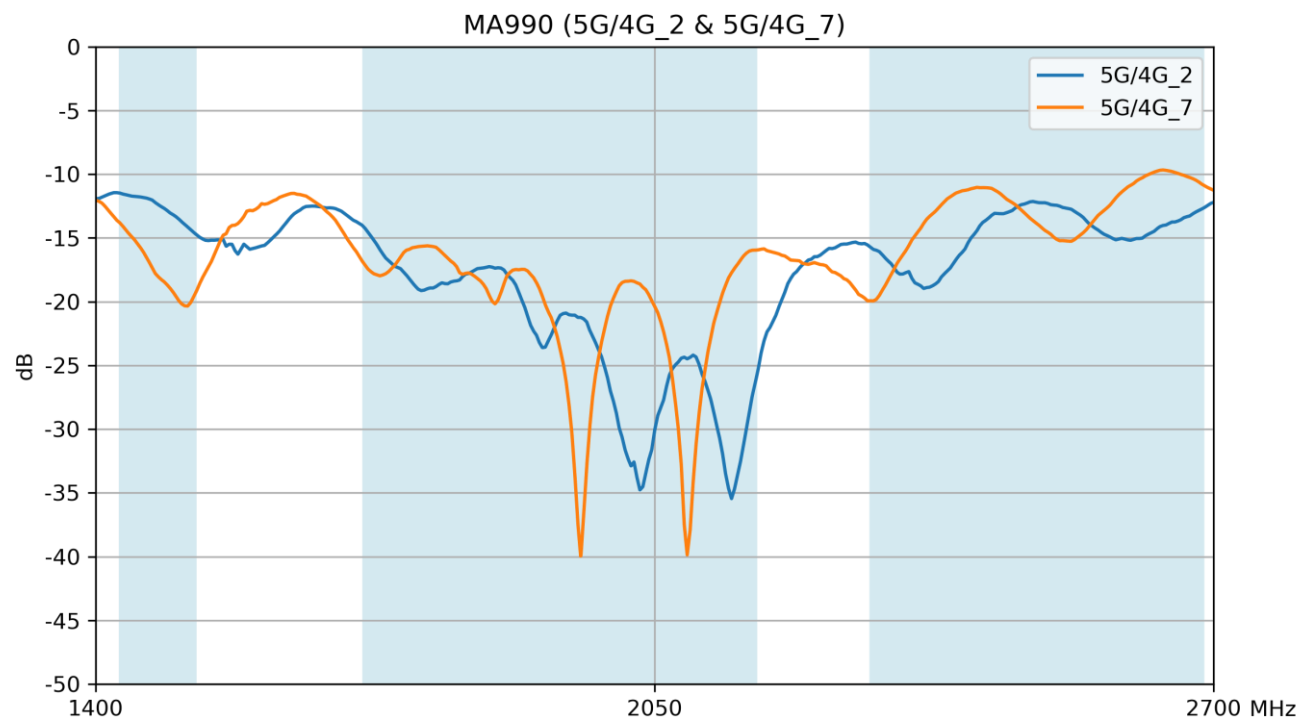

### 3.9 Return Loss - 5G/4G 3 & 6

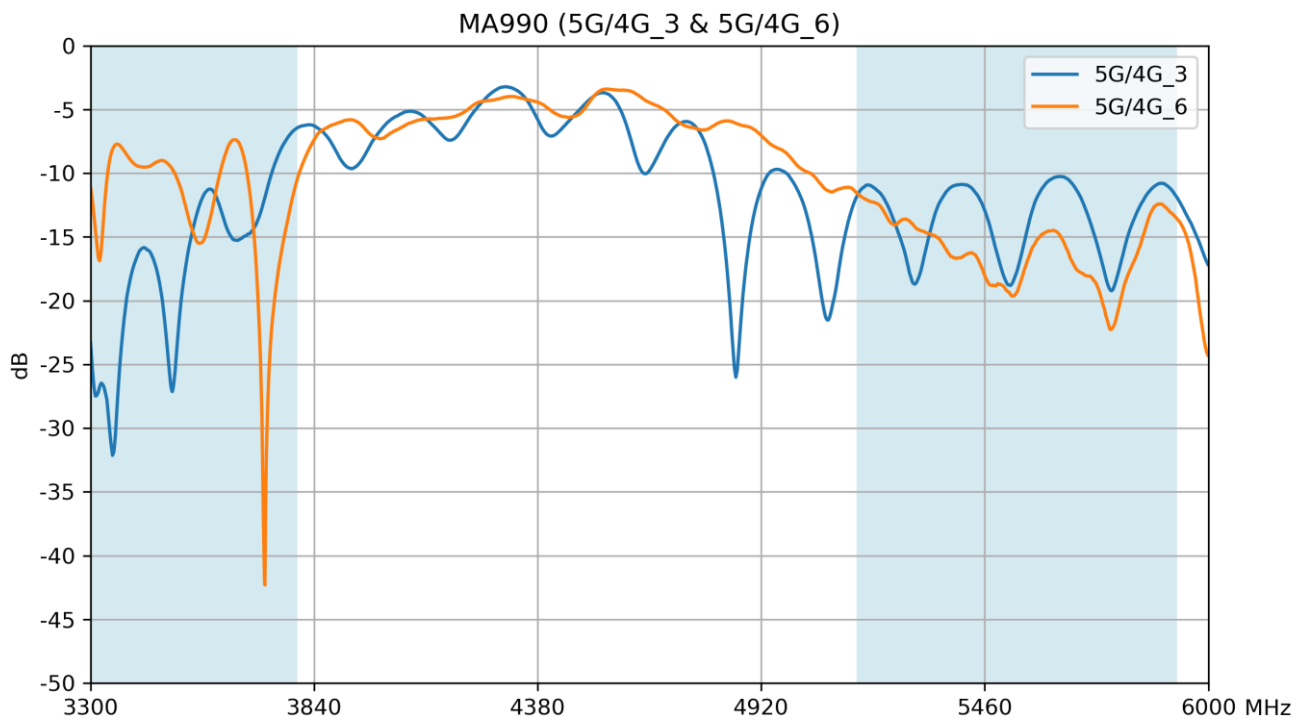

### 3.10 Return Loss - 5G/4G 4 & 5

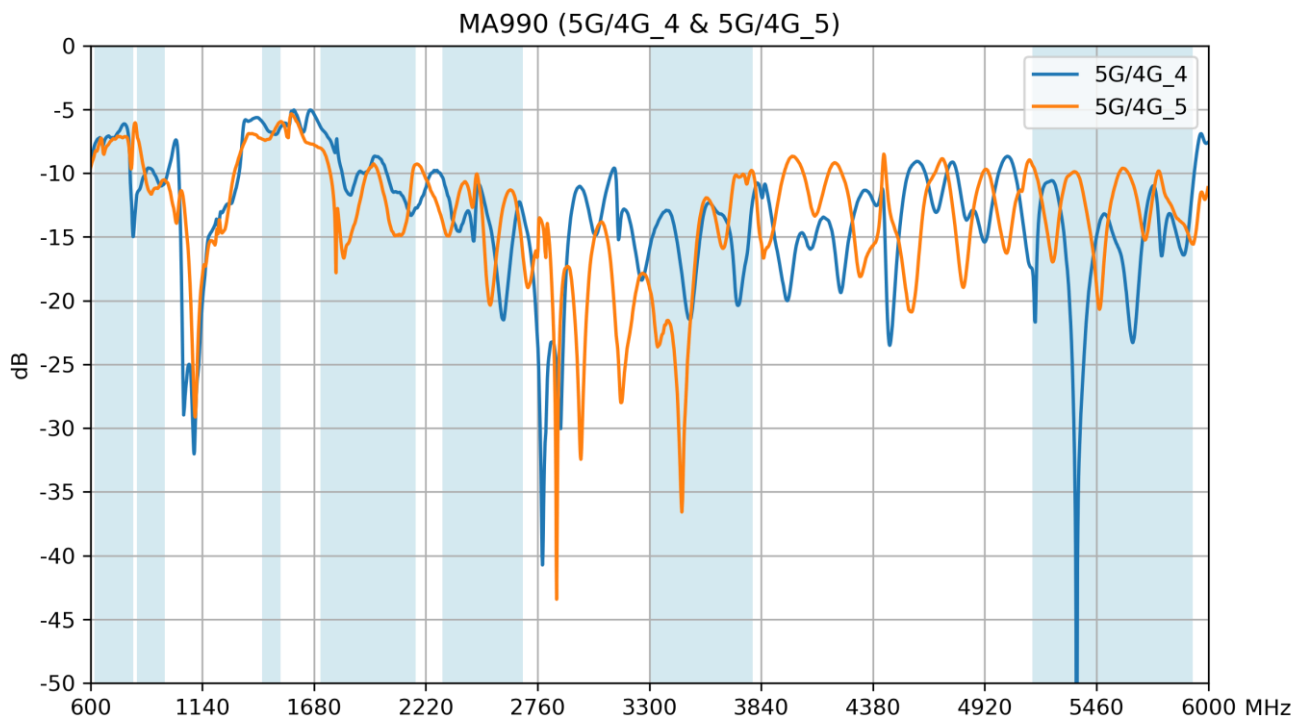

### 3.11 Isolation – 5G/4G 1 & 8

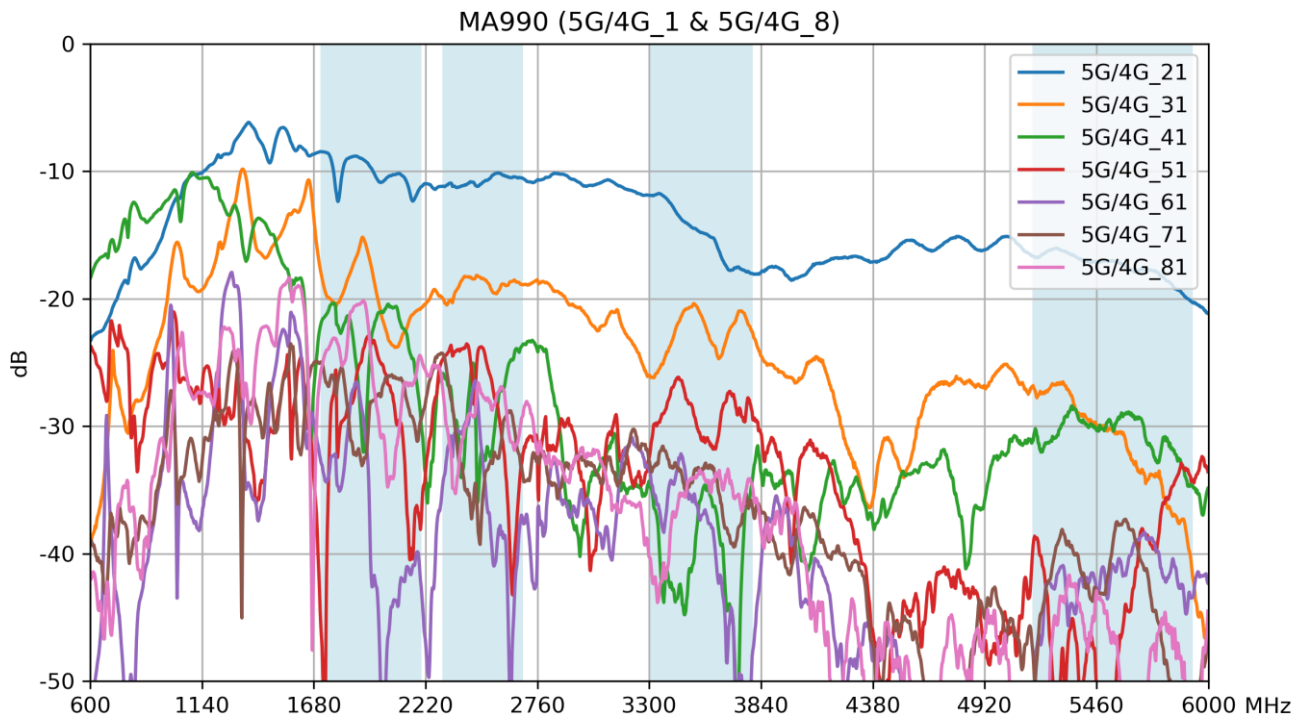

### 3.12 Isolation – 5G/4G 2 & 7

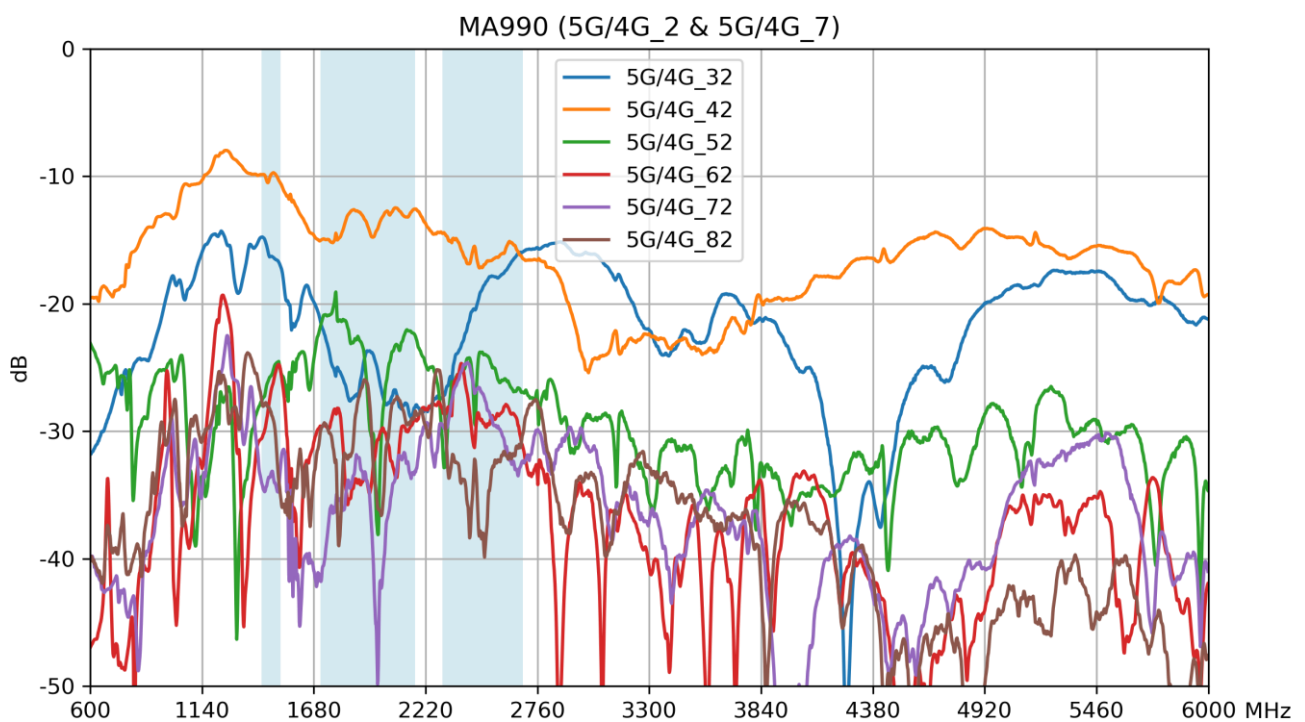

### 3.13 Isolation – 5G/4G 3 & 6

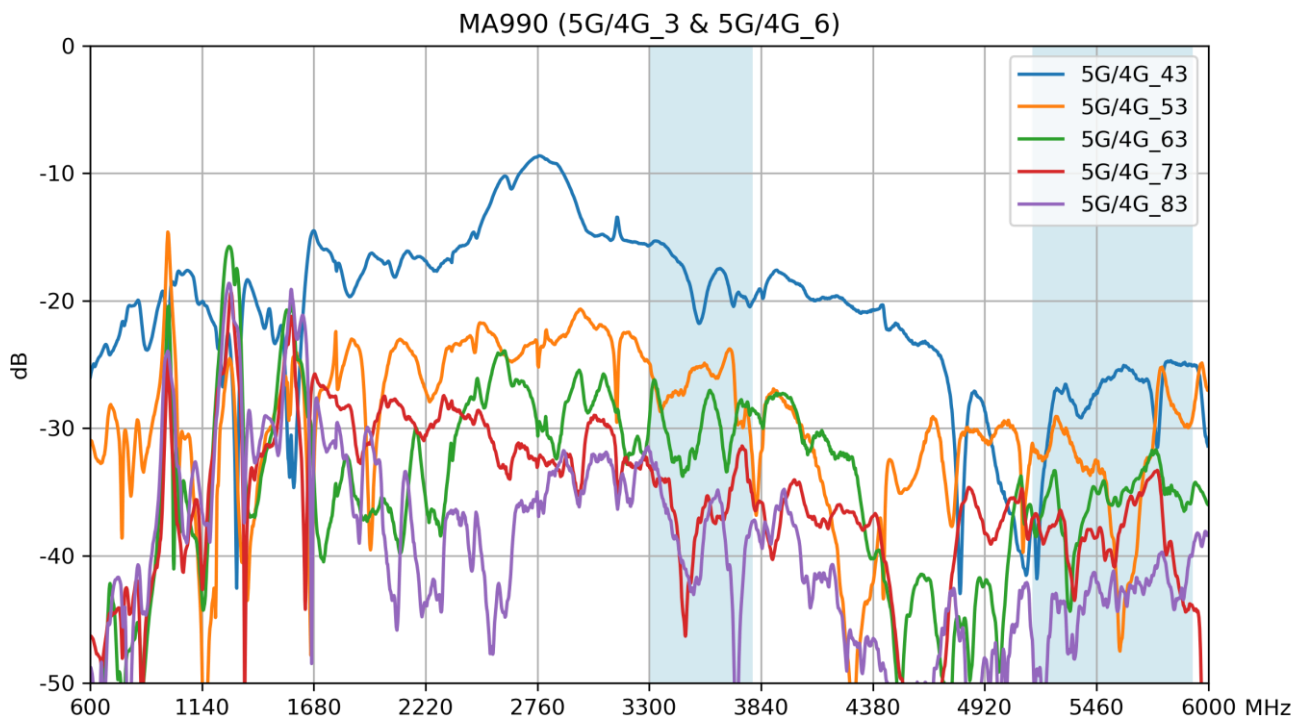

### 3.14 Isolation – 5G/4G 4 & 5

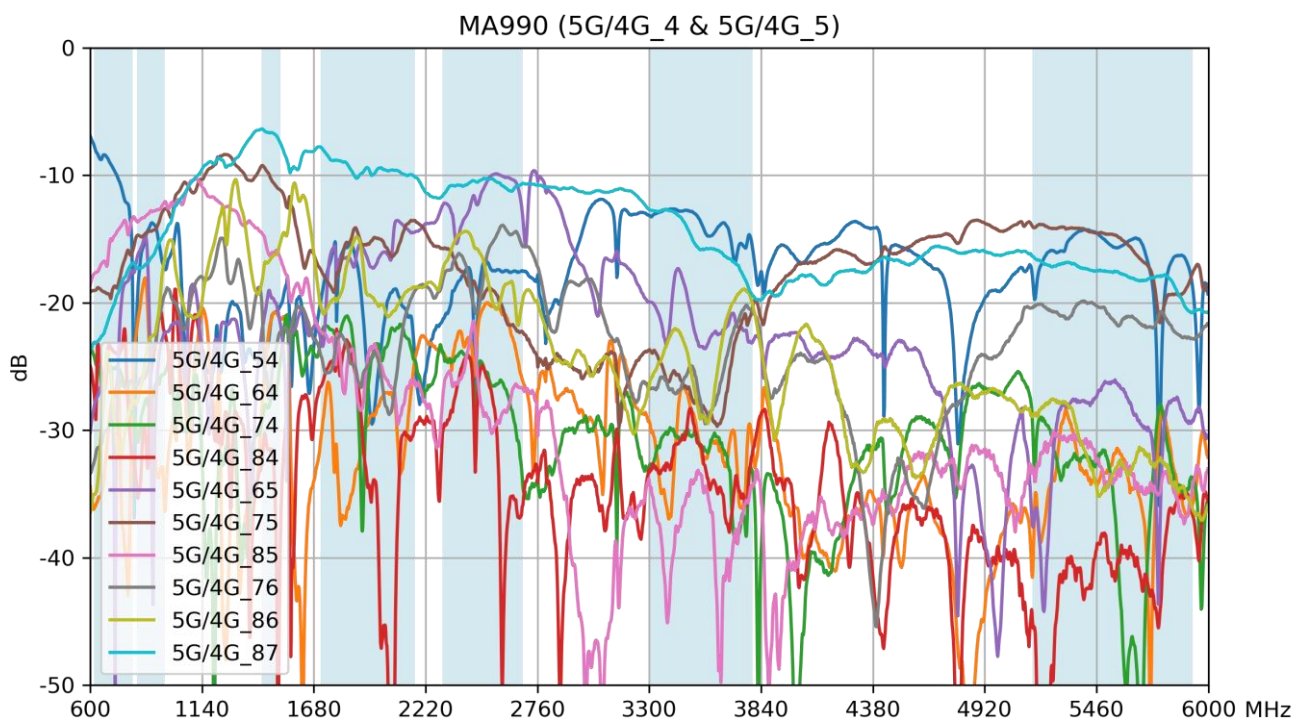



### 3.15 Efficiency – 5G/4G 1 & 8

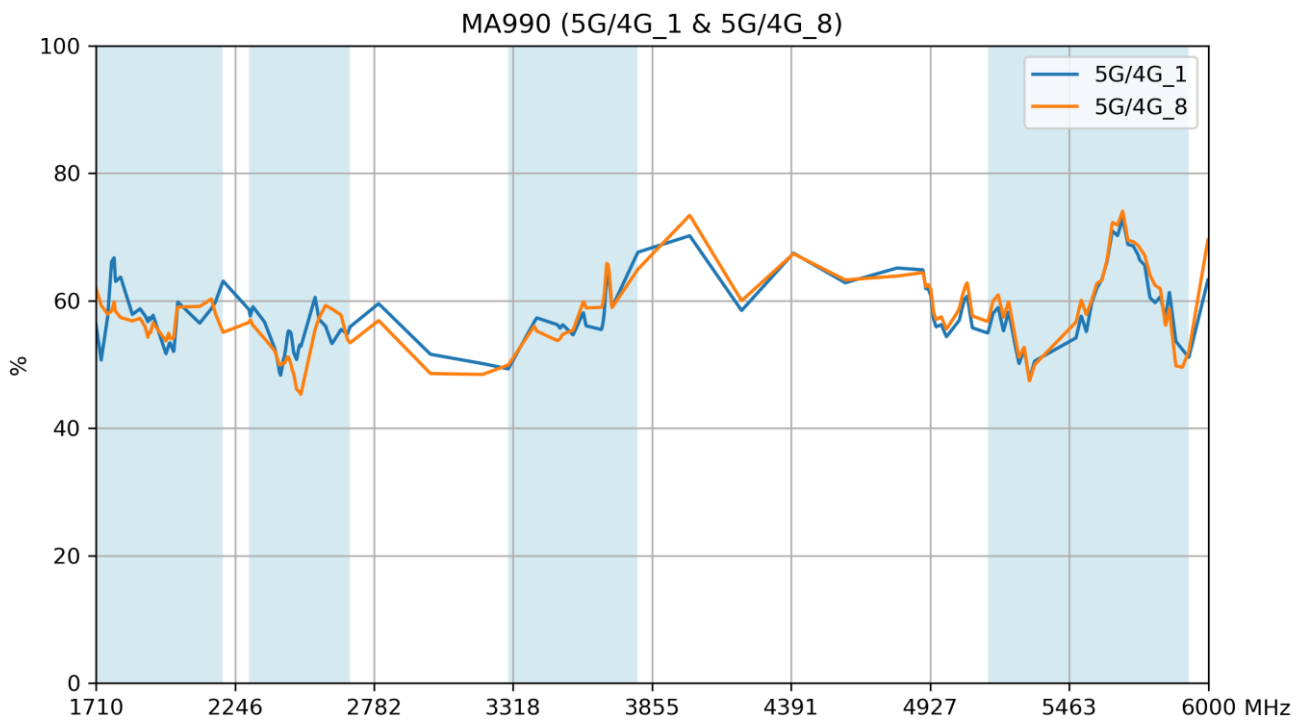

### 3.16 Efficiency – 5G/4G 2 & 7

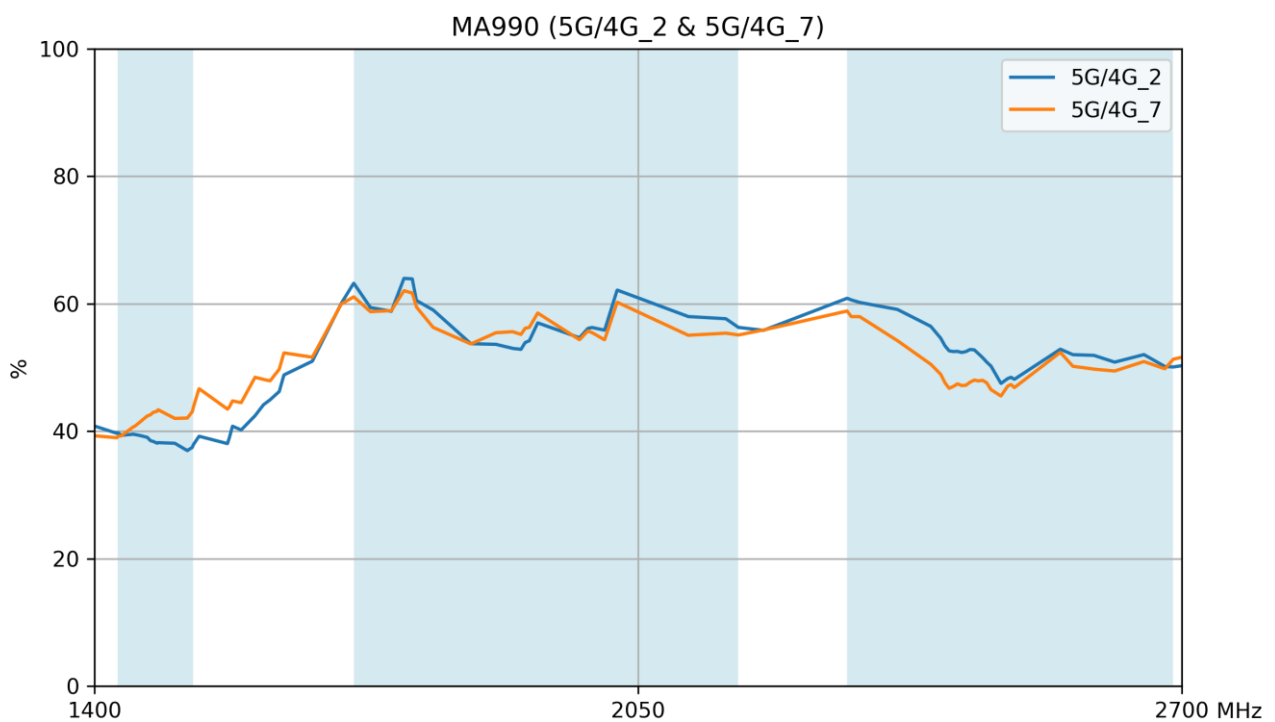

### 3.17 Efficiency – 5G/4G 3 & 6

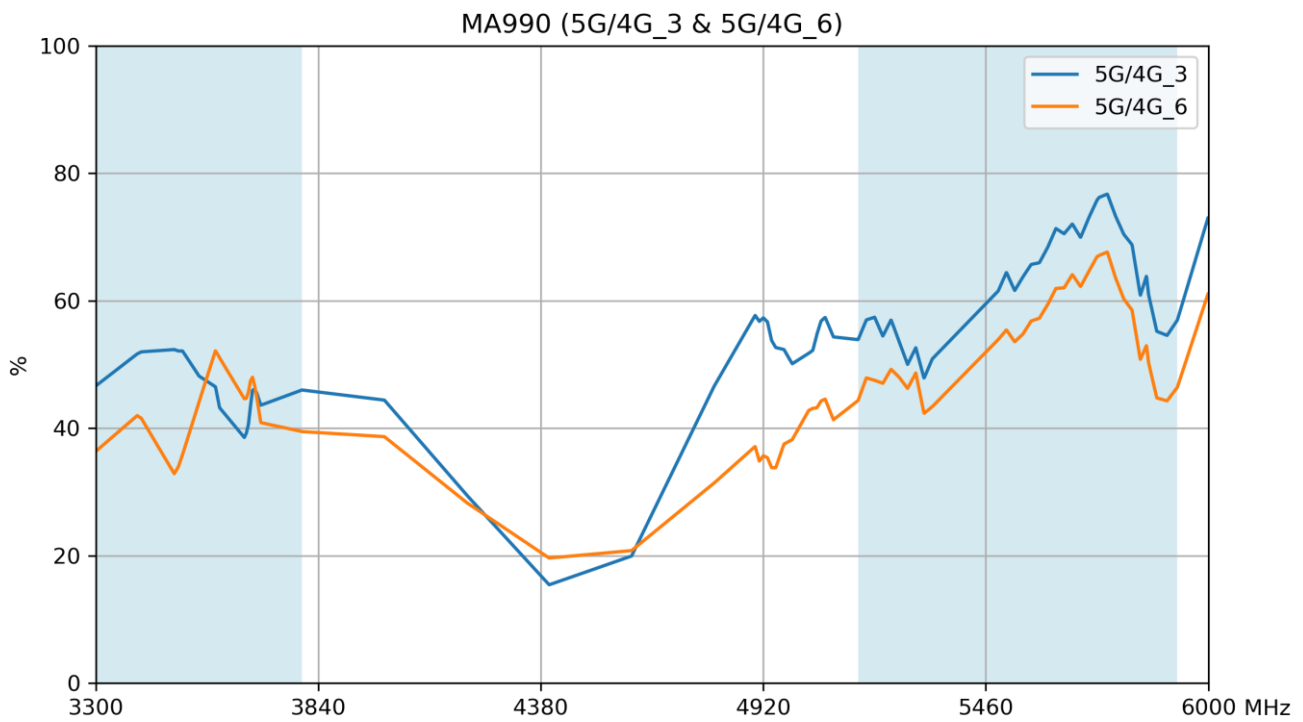

### 3.18 Efficiency – 5G/4G 4 & 5

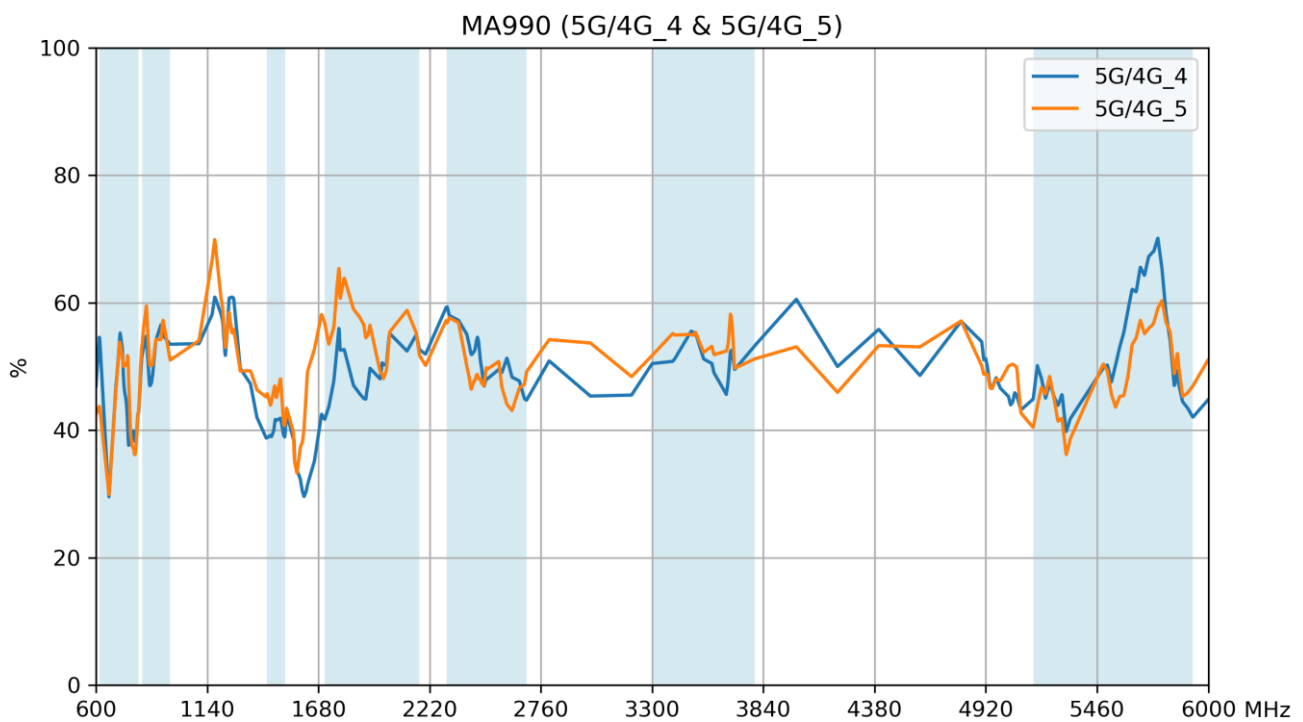

### 3.19 Average Gain – 5G/4G 1 & 8

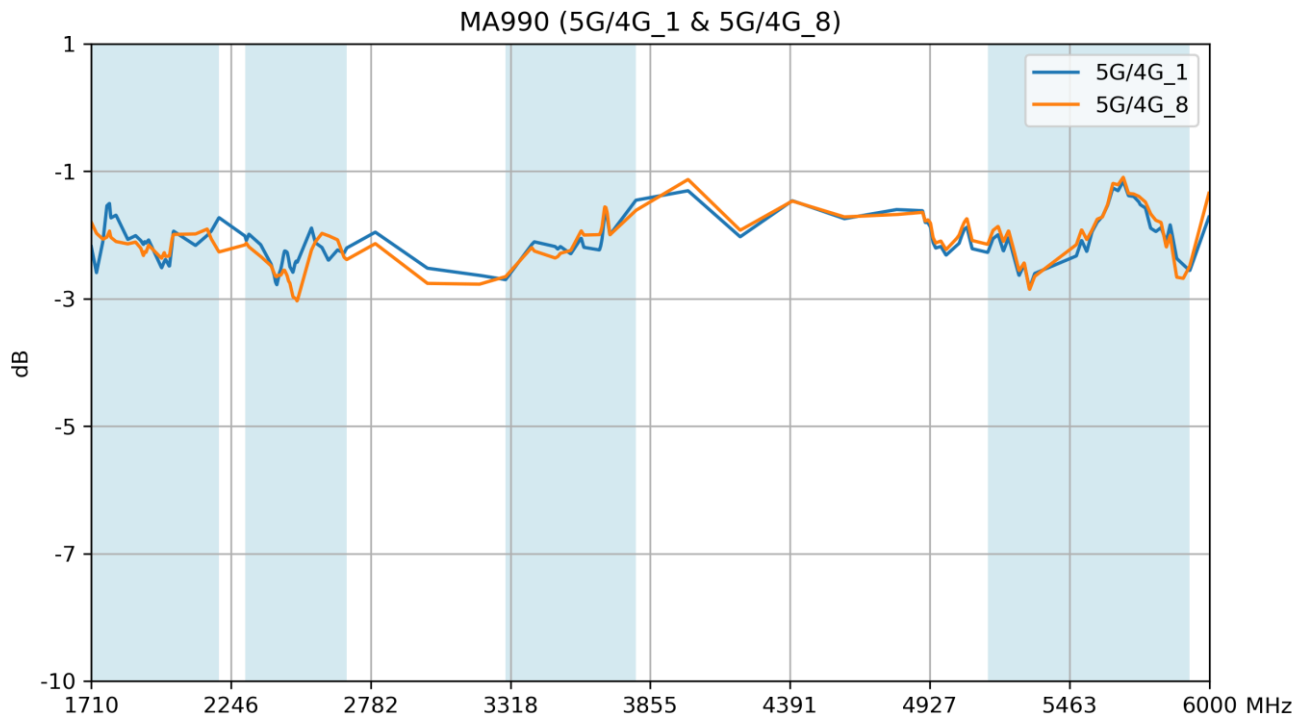

### 3.20 Average Gain – 5G/4G 2 & 7

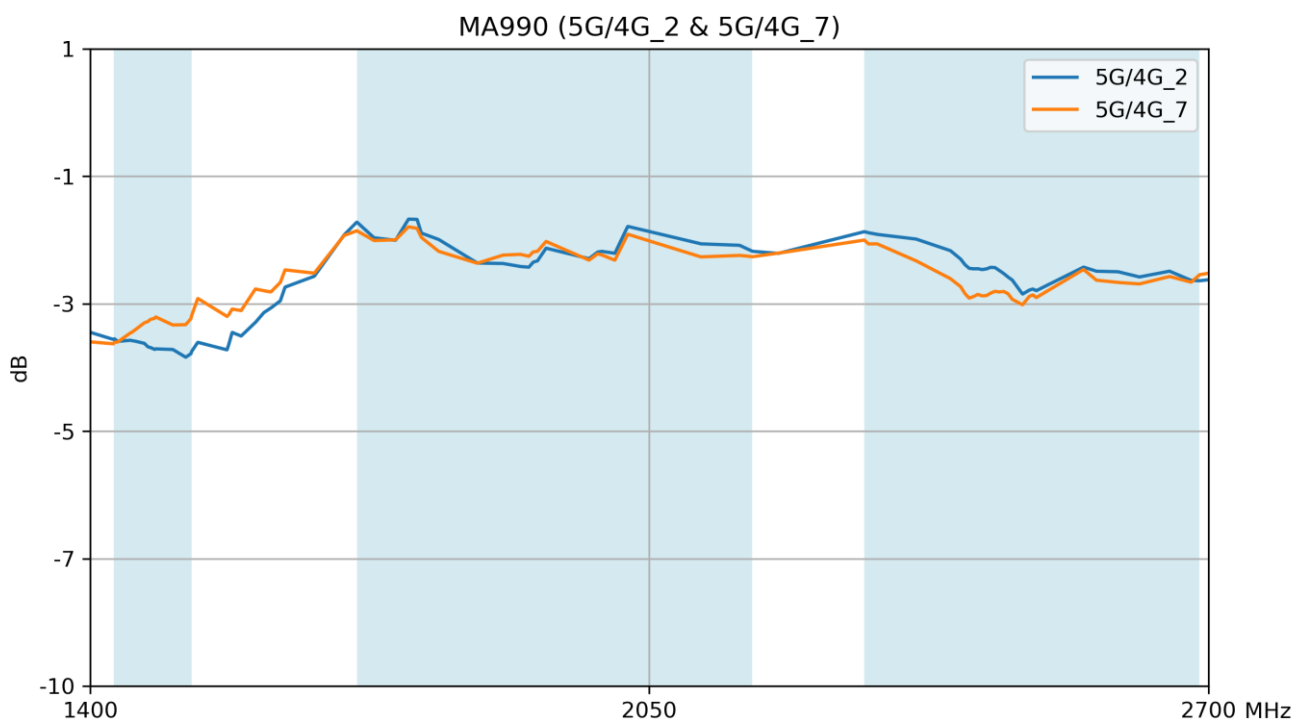

### 3.21 Average Gain – 5G/4G 3 & 6

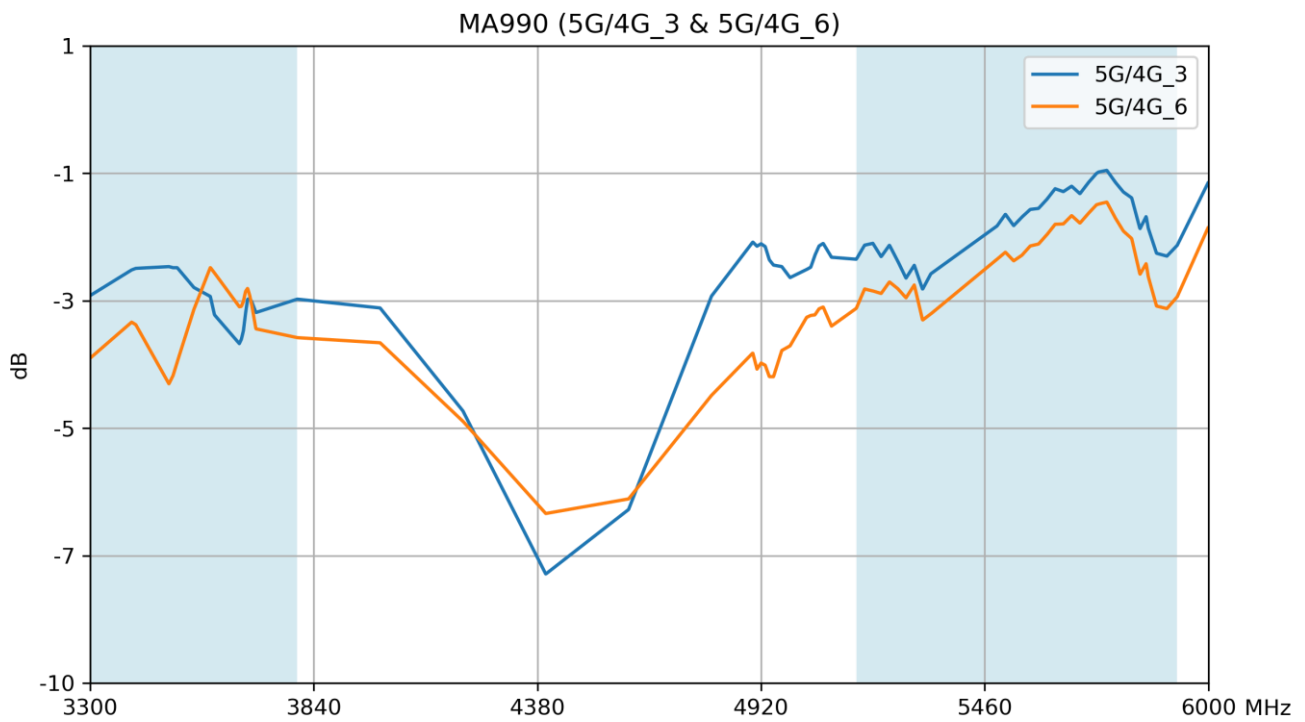

### 3.22 Average Gain – 5G/4G 4 & 5

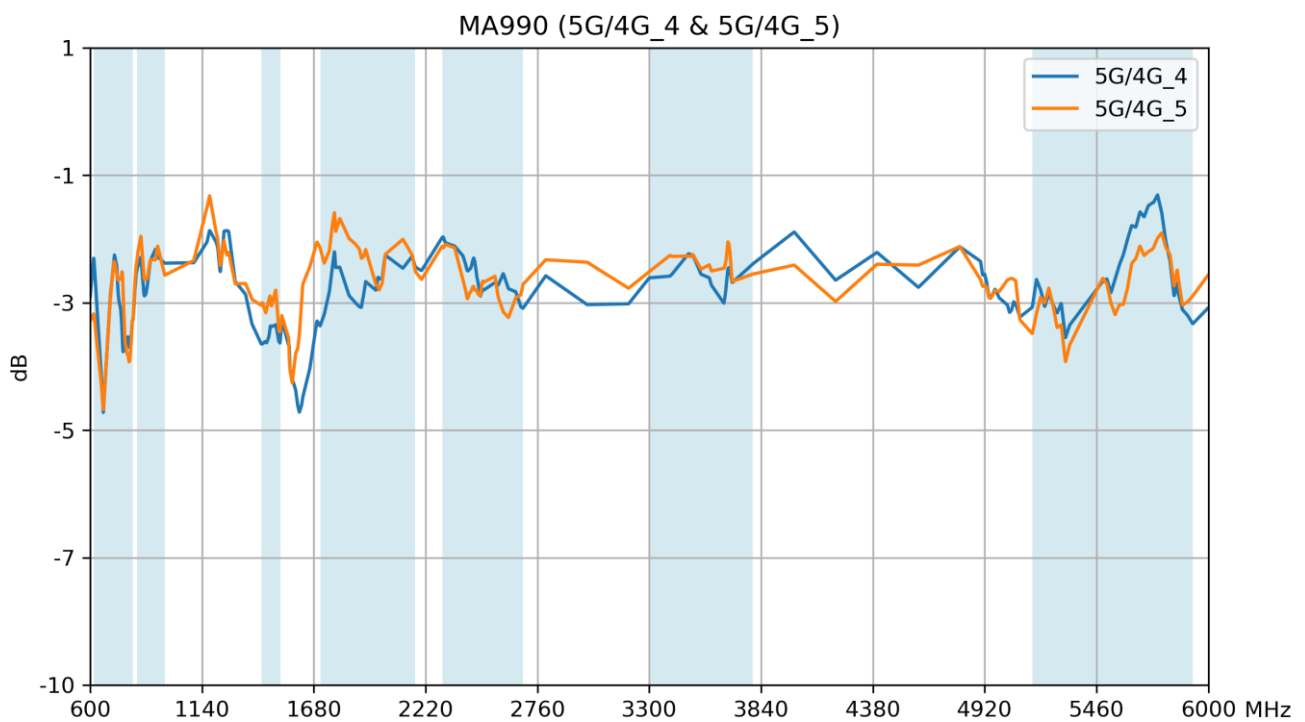

### 3.23 Peak Gain – 5G/4G 1 & 8

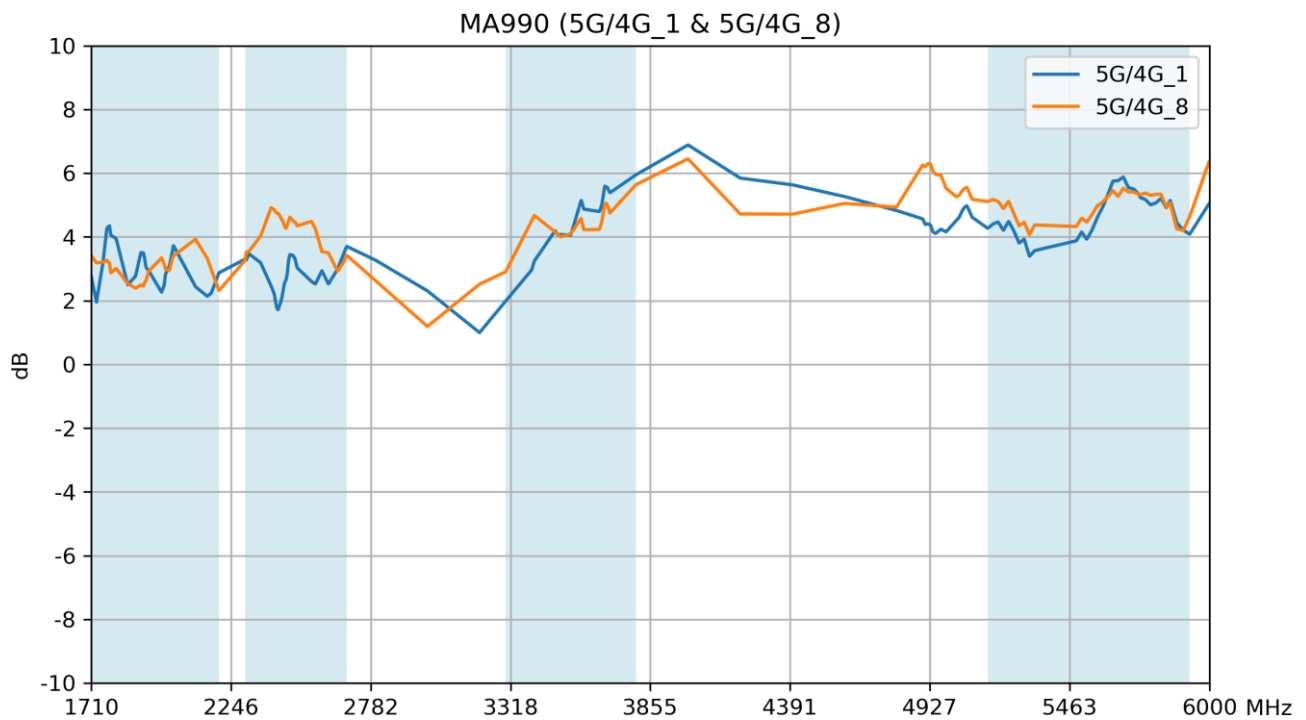

### 3.24 Peak Gain – 5G/4G 2 & 7

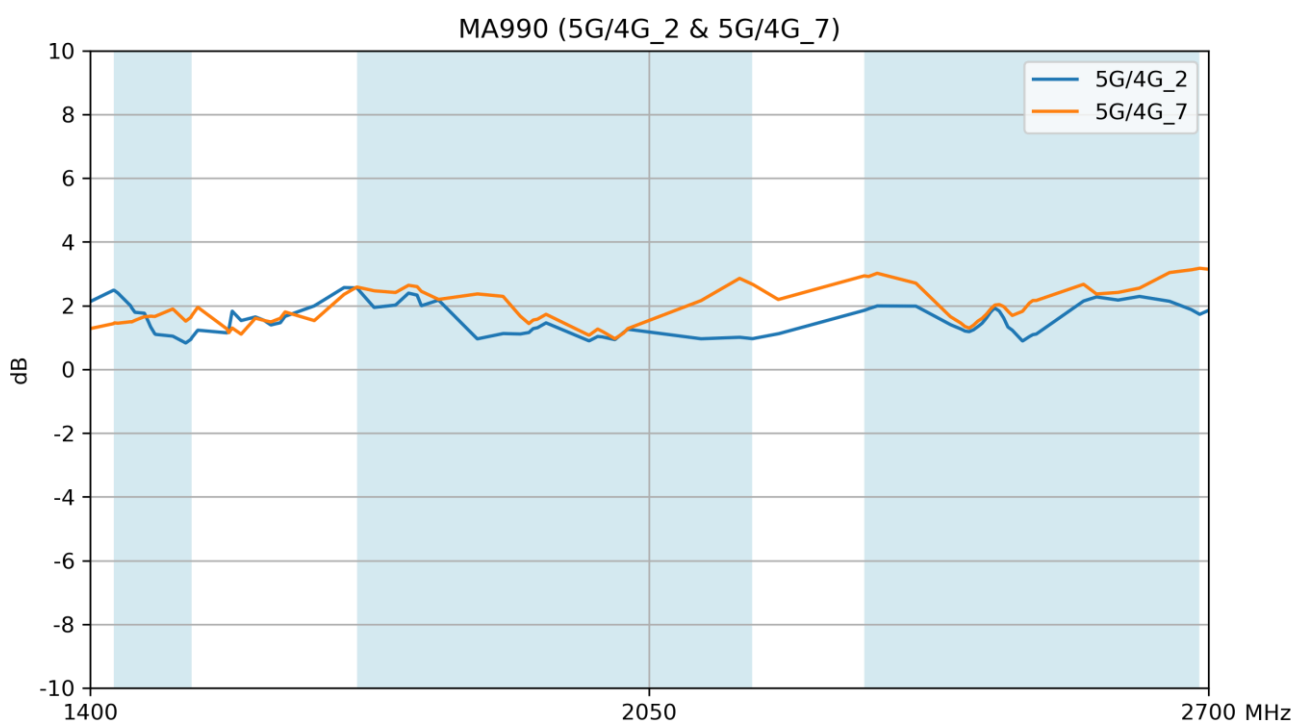

### 3.25 Peak Gain – 5G/4G 3 & 6

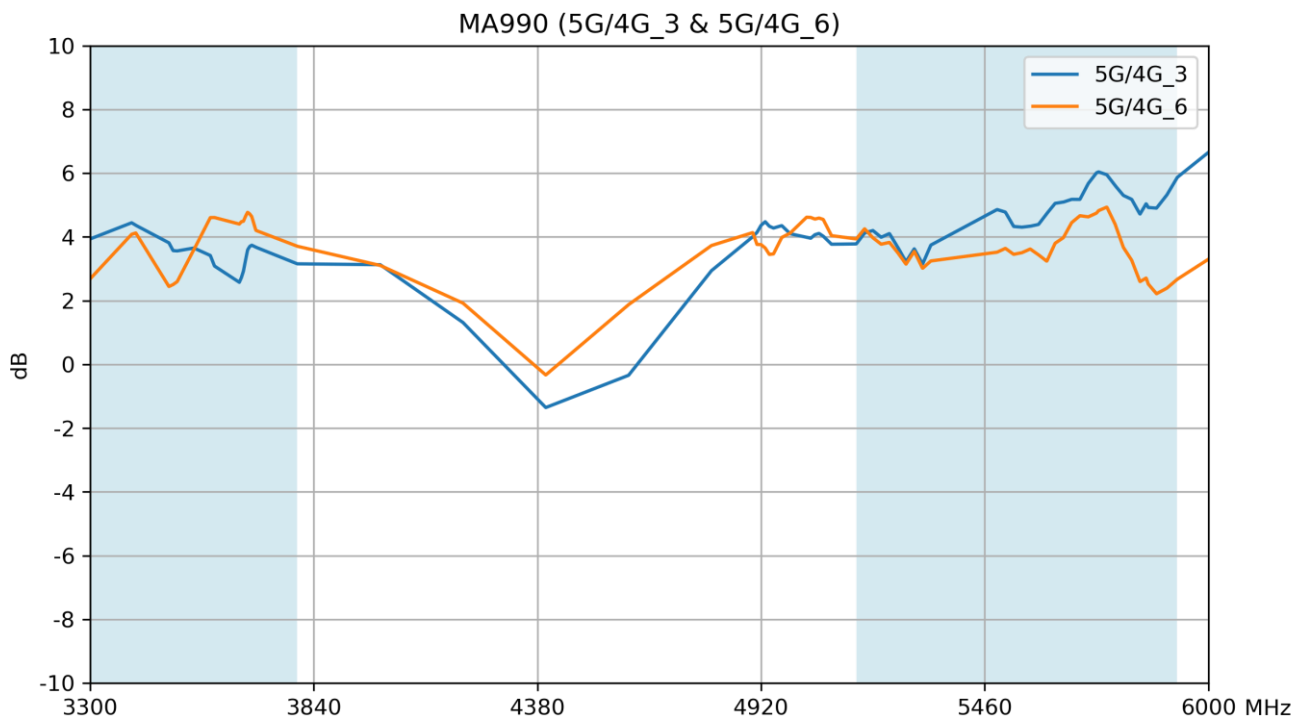

### 3.26 Peak Gain – 5G/4G 4 & 5

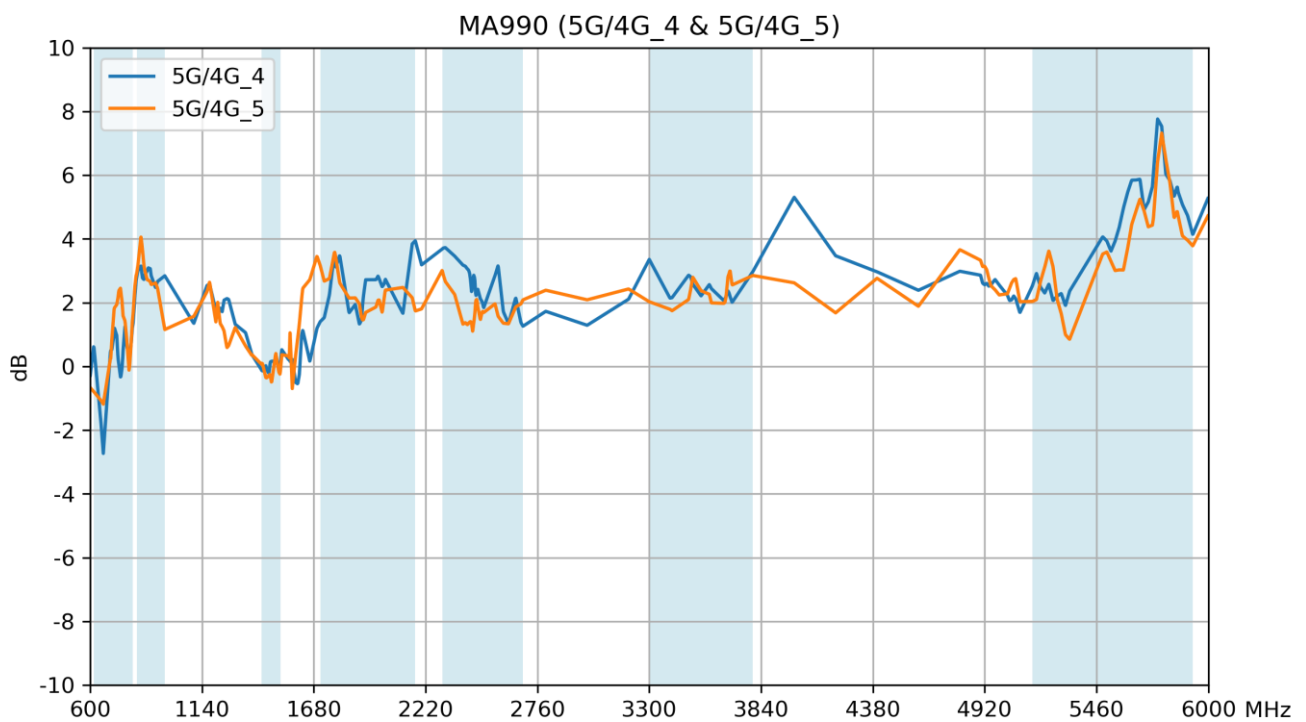

## 4. Active Antenna Characteristics

### 4.1 Block Diagram

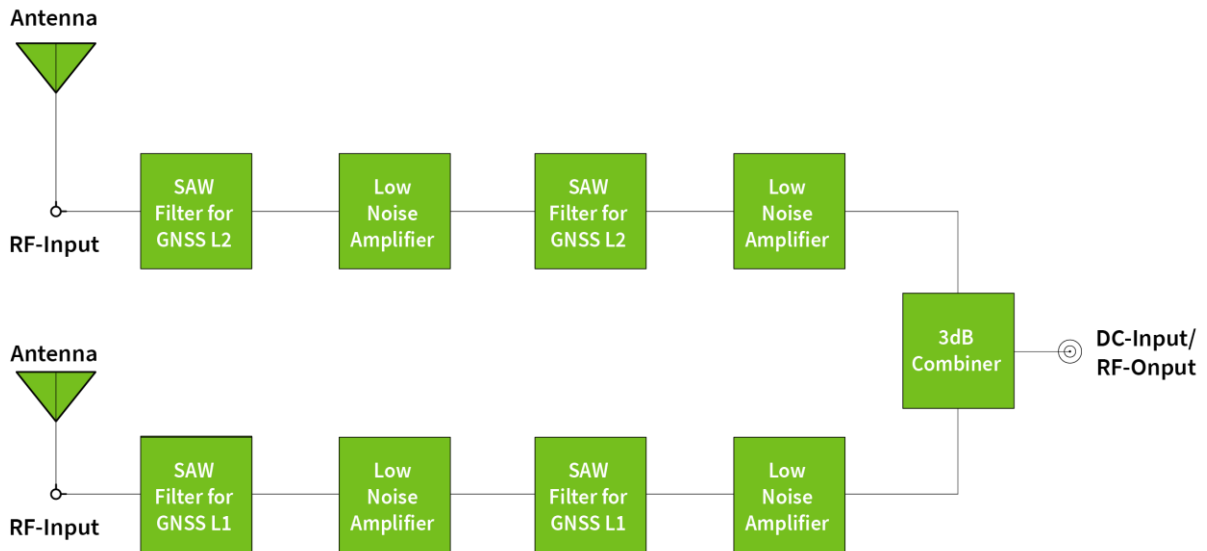

### 4.2 LNA Gain @3.0V

GNSS L1

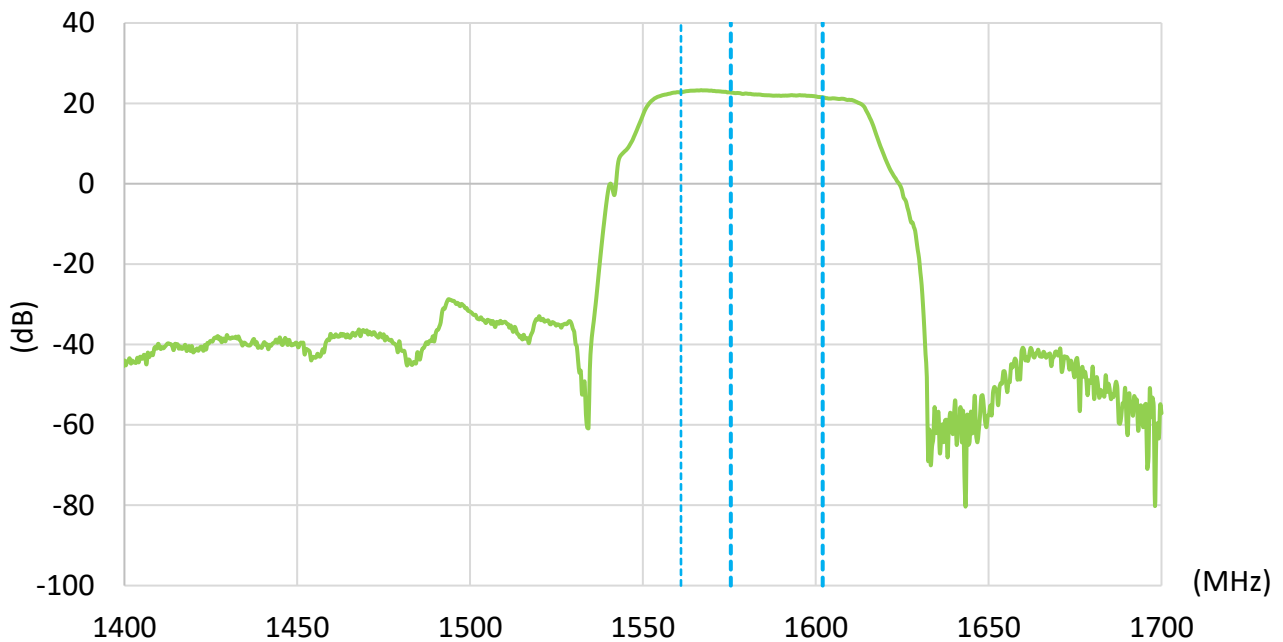

GNSS L2

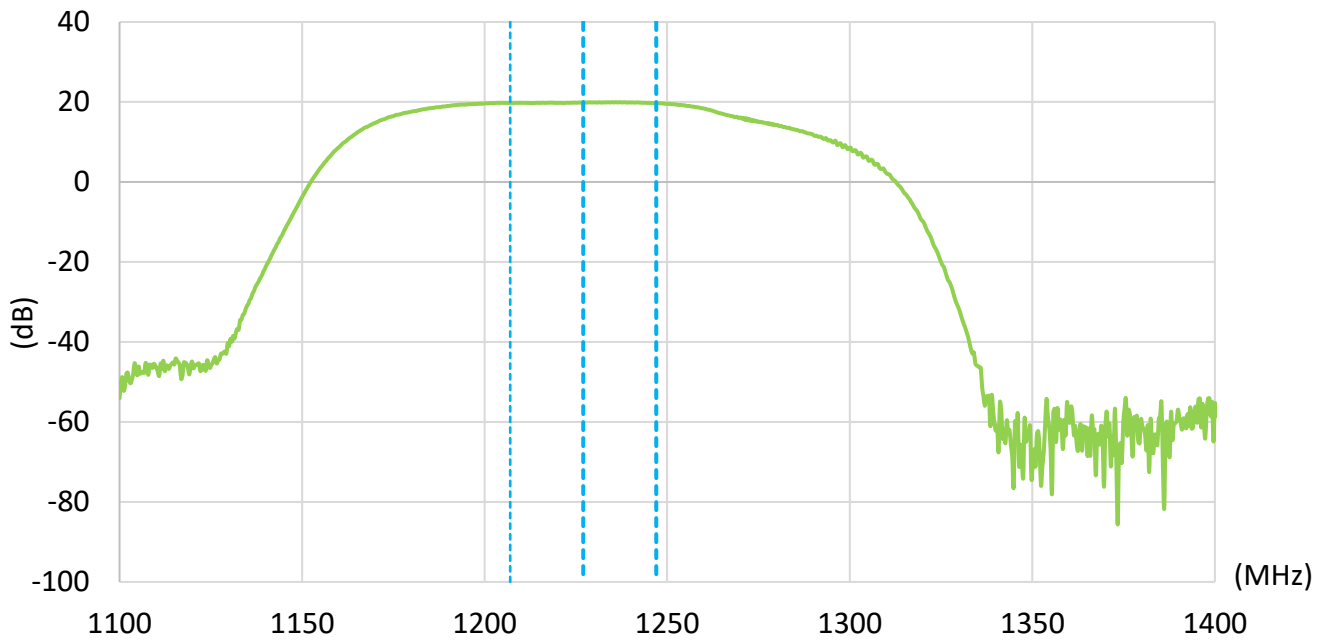

**4.3** Out of Band Rejection

GNSS L1

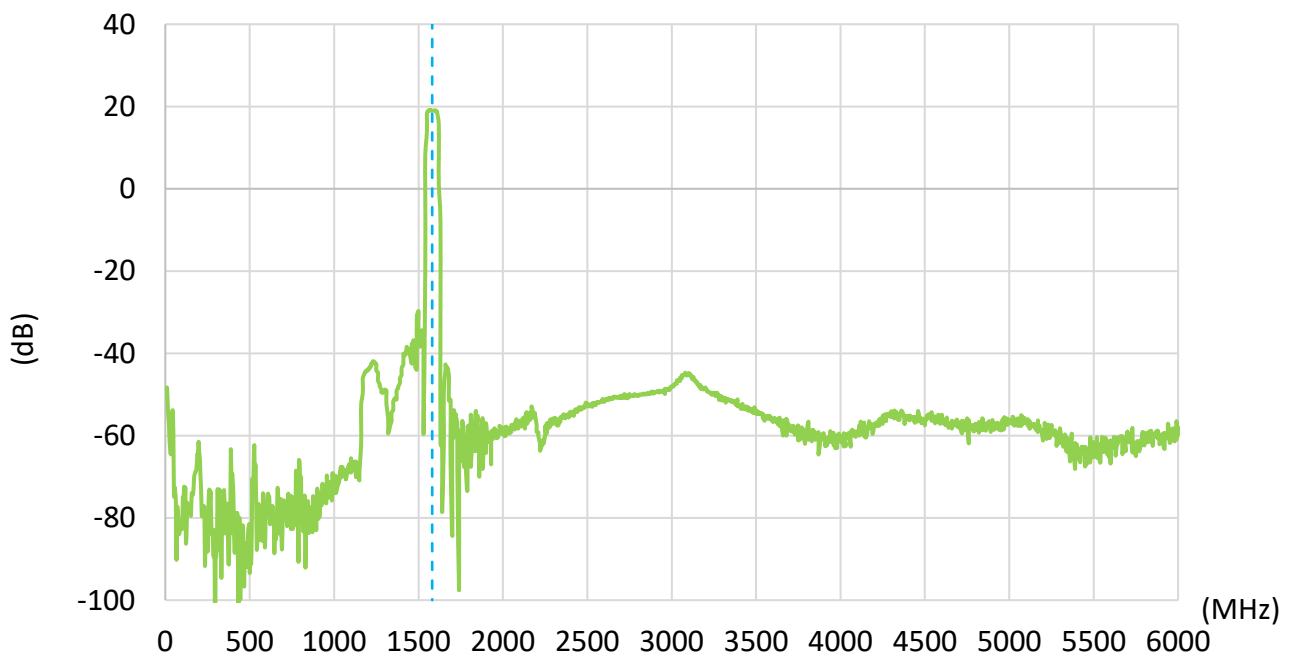



### GNSS L2

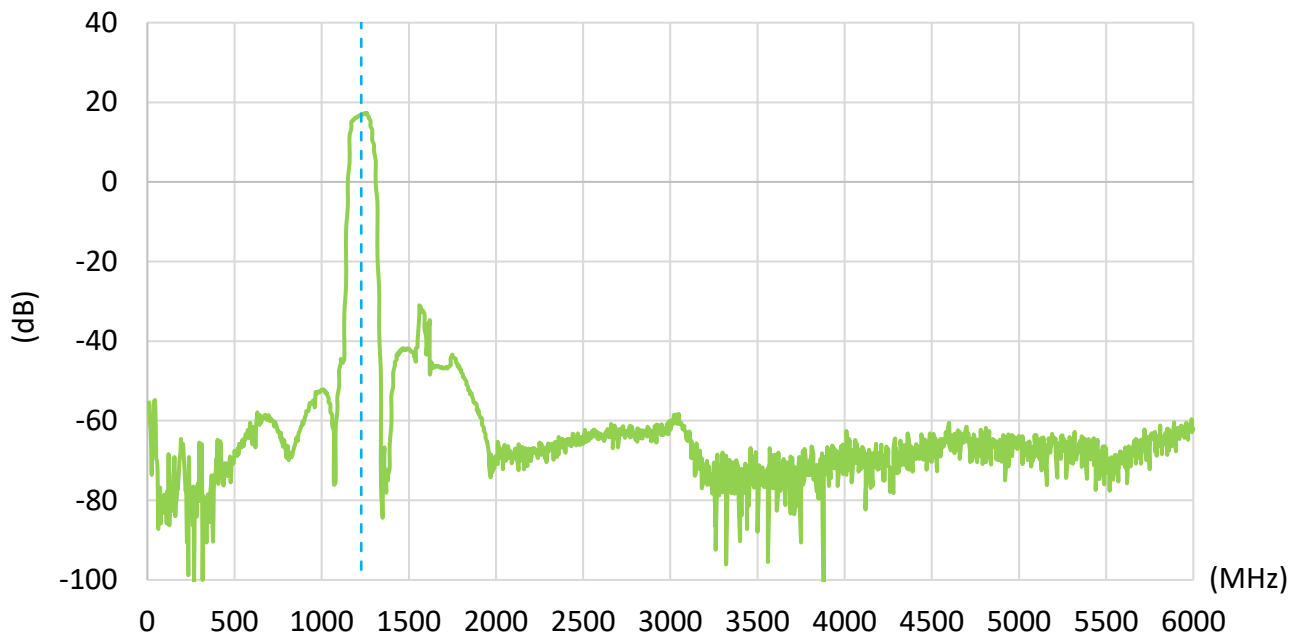

### 3.11 Noise Figure

### GNSS L1

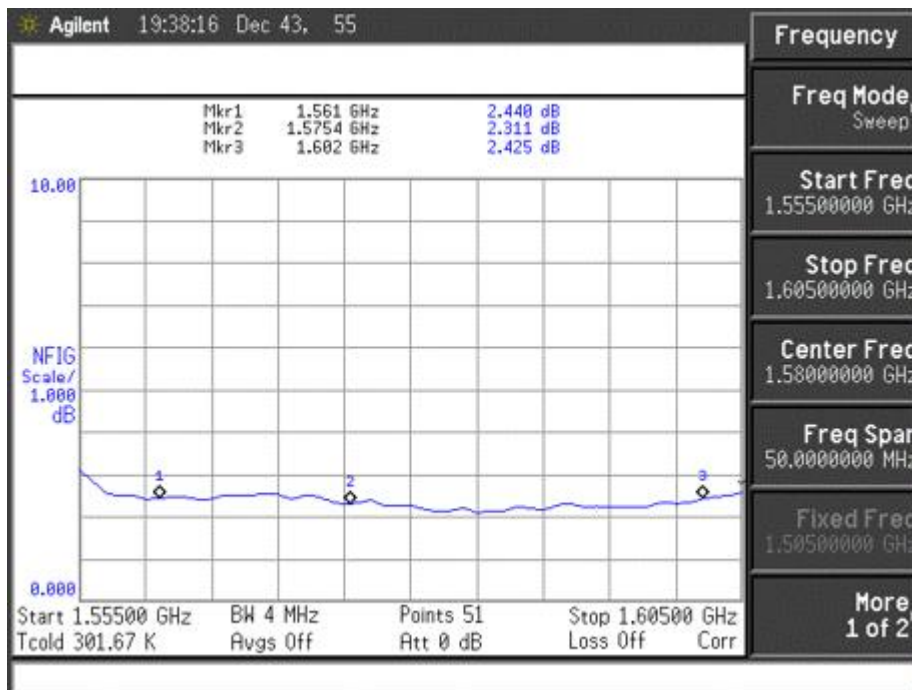

GNSS L2

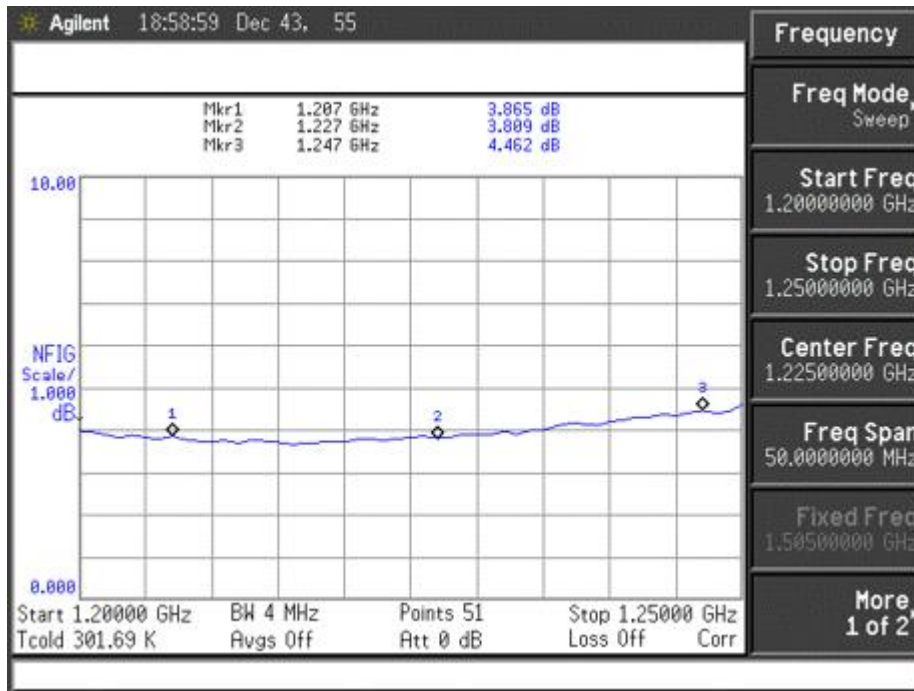

# 5. Radiation Patterns

## 5.1 GNSS 3D and 2D Radiation Patterns

**1207MHz**

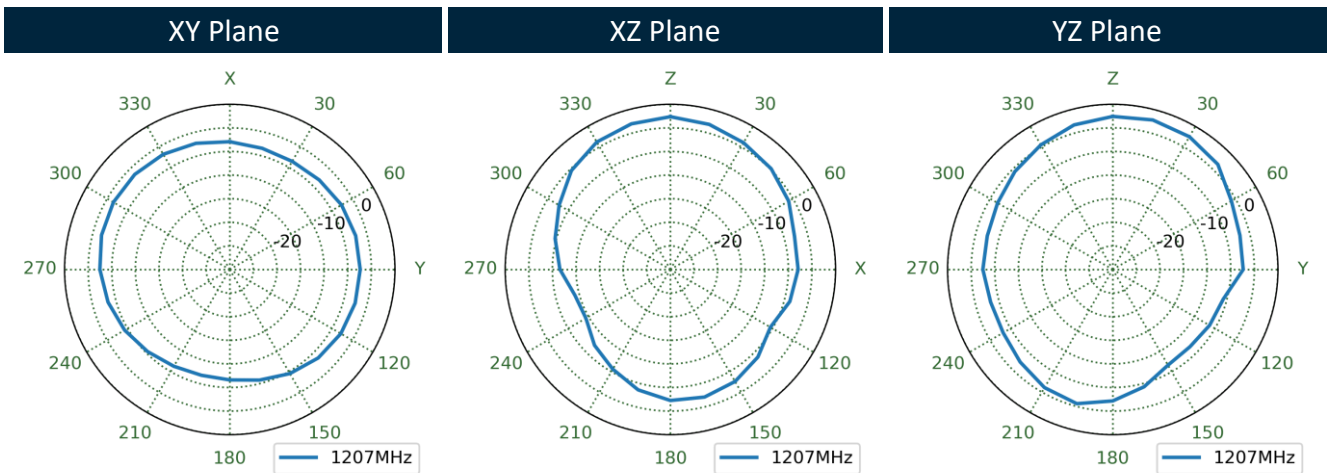
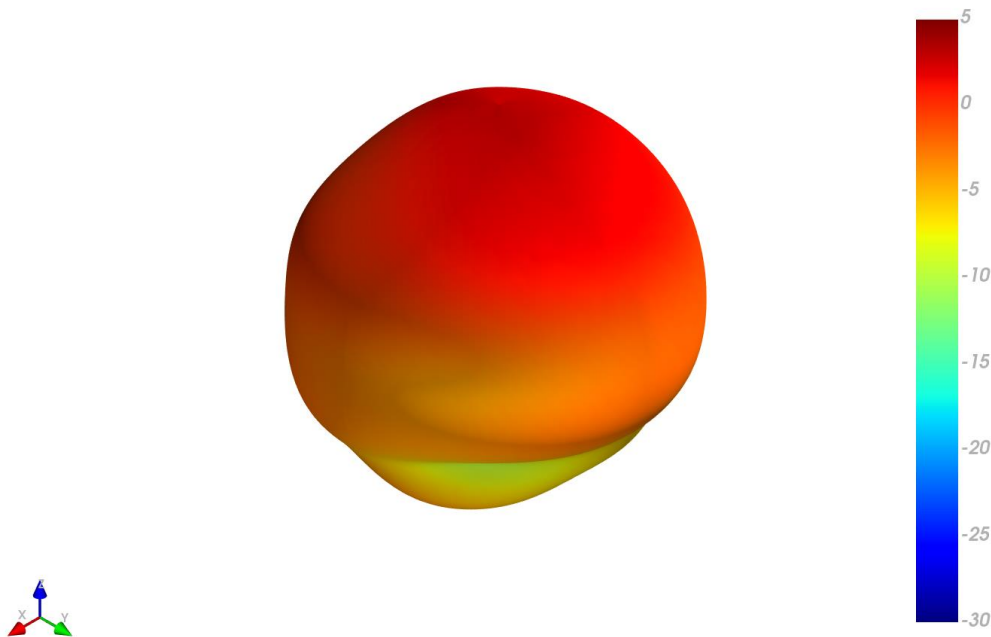

# 1227MHz

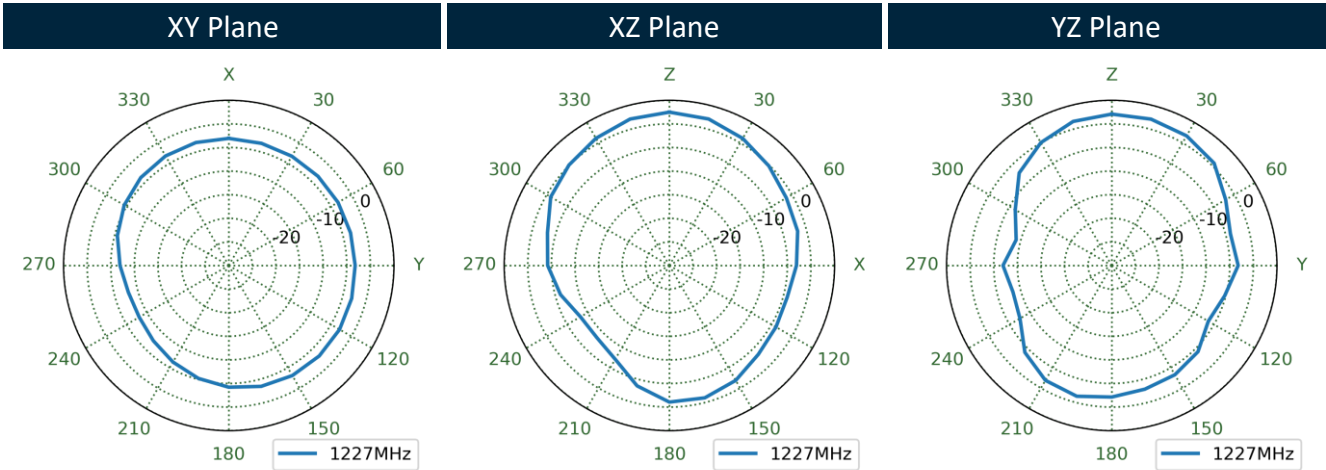
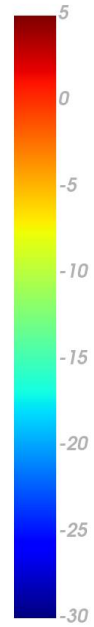
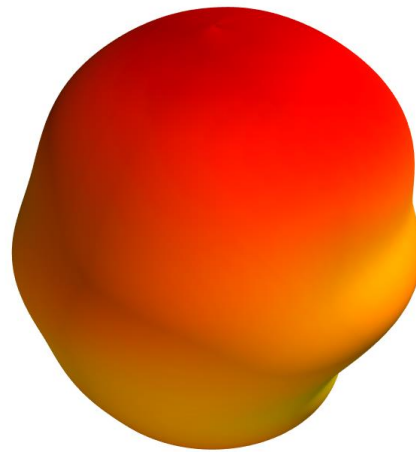

# 1248MHz

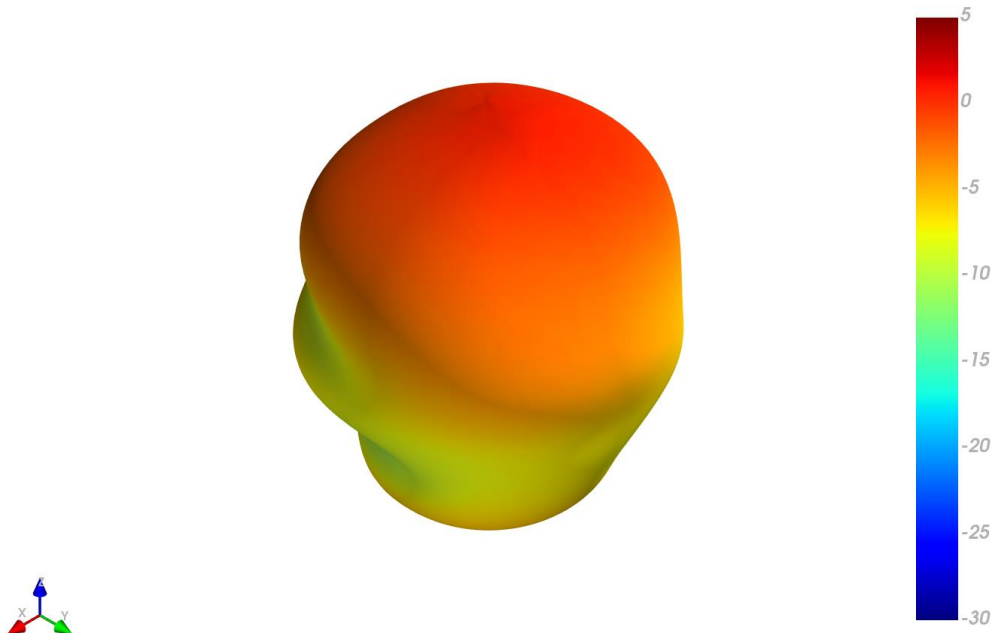

**XY Plane**

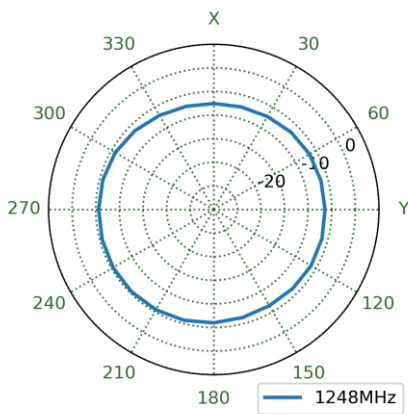

**XZ Plane**

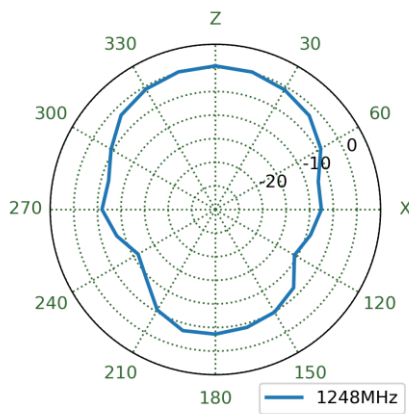

**YZ Plane**

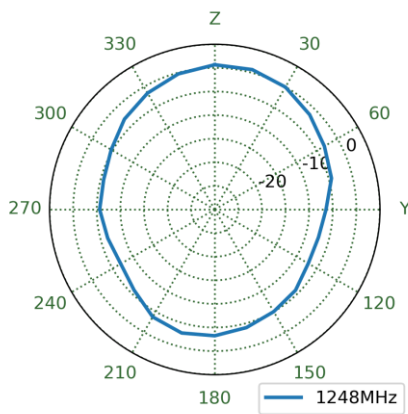

1561MHz

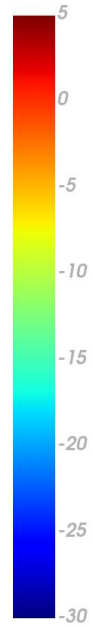
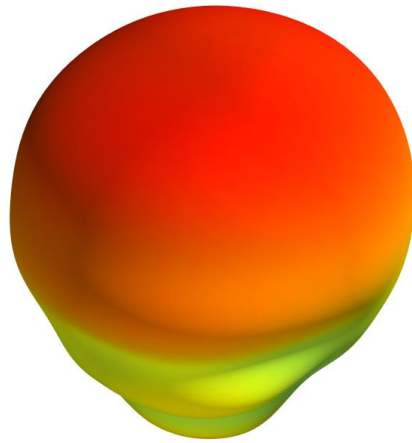

XY Plane

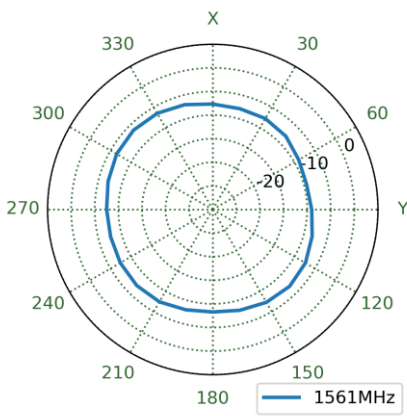

XZ Plane

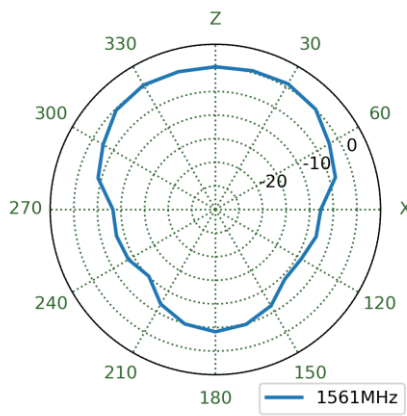

YZ Plane

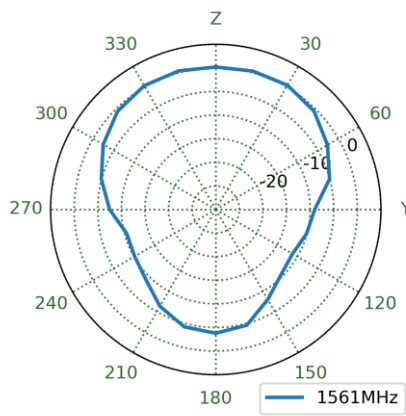

1575MHz

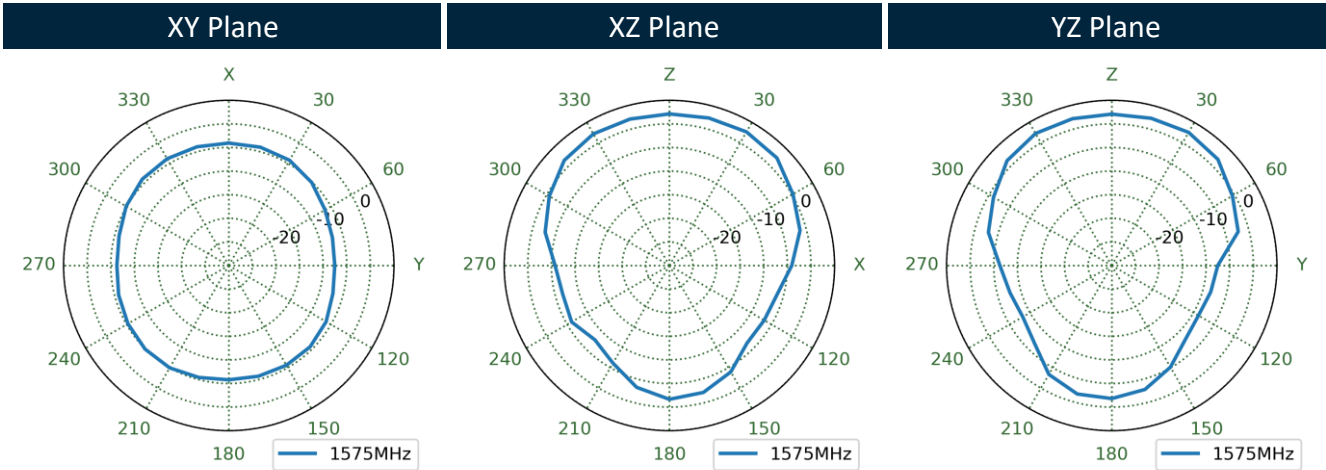
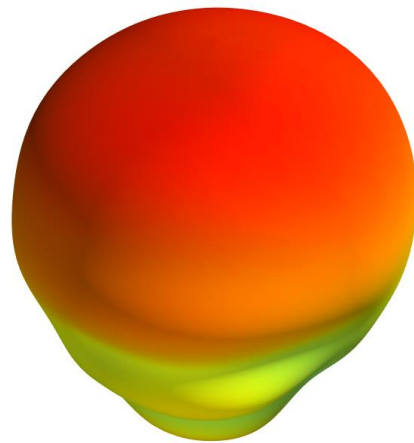

1602MHz

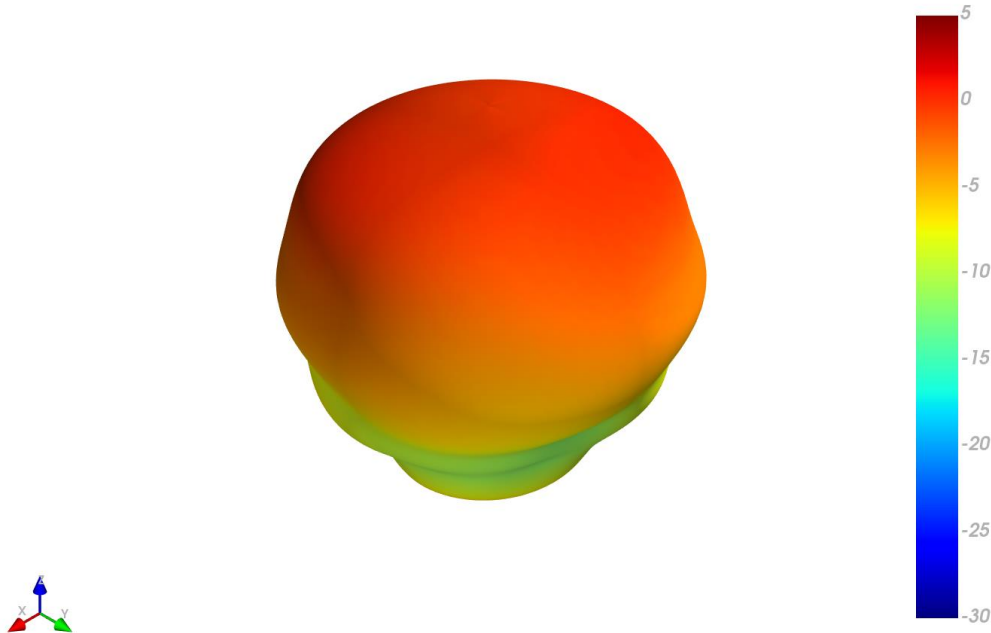

XY Plane

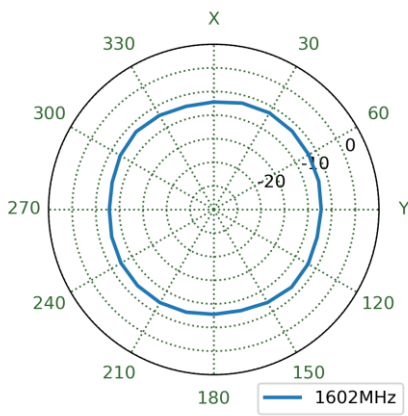

XZ Plane

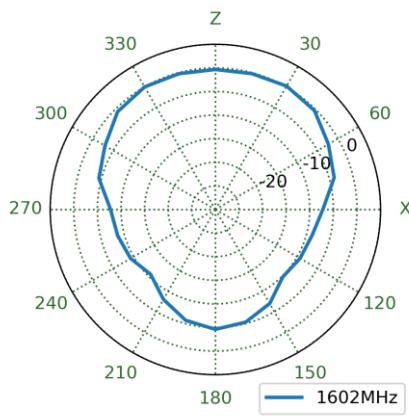

YZ Plane

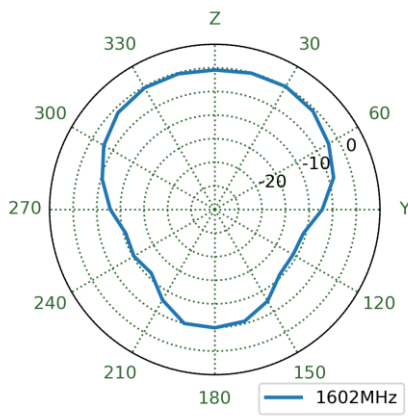



5.2 5G/4G 1 3D and 2D Radiation Patterns

1710MHz

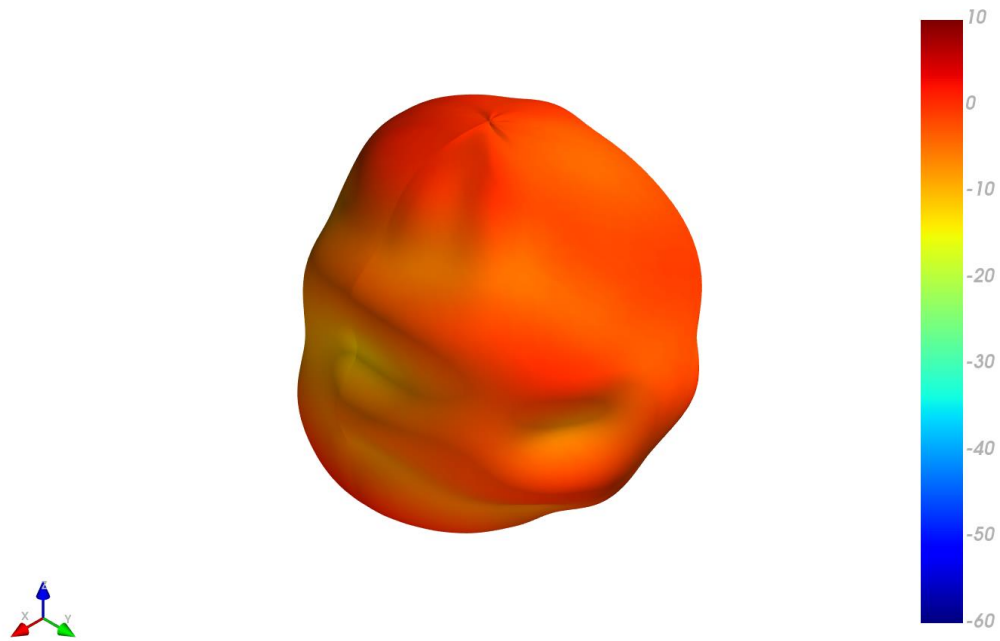

XY Plane

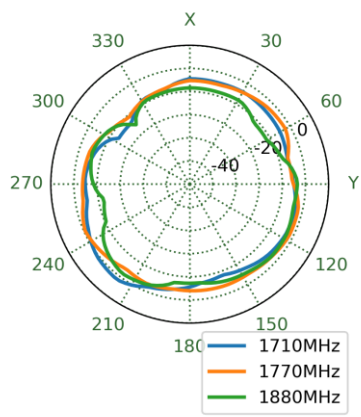

XZ Plane

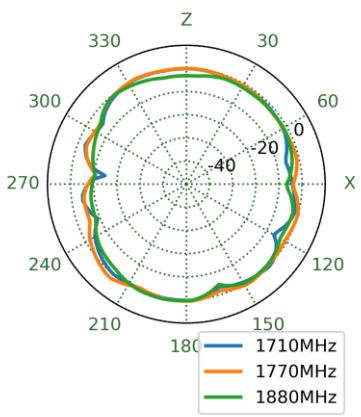

YZ Plane

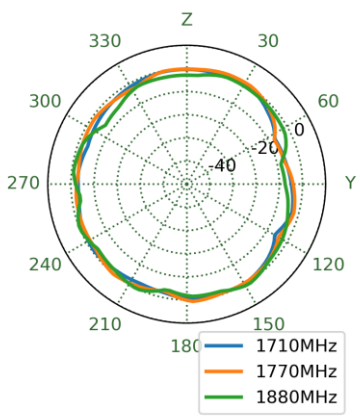

## 1910MHz

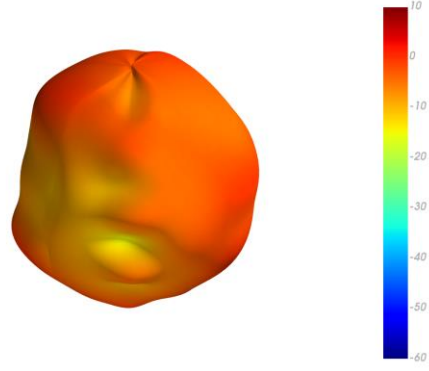

### XY Plane

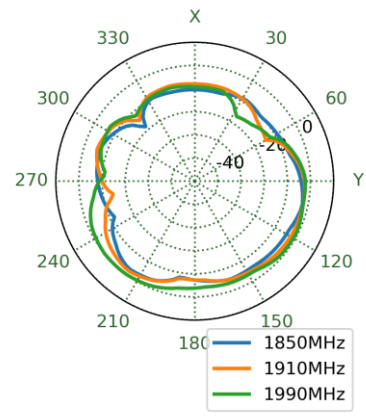

### XZ Plane

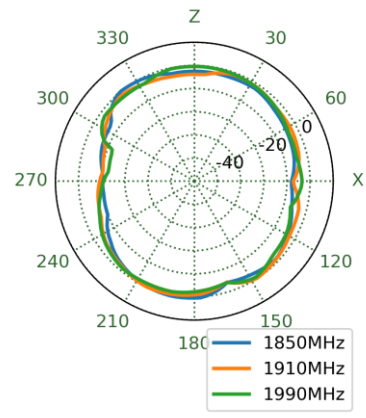

### YZ Plane

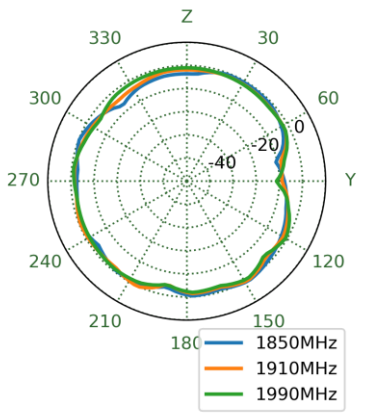

## 1995MHz

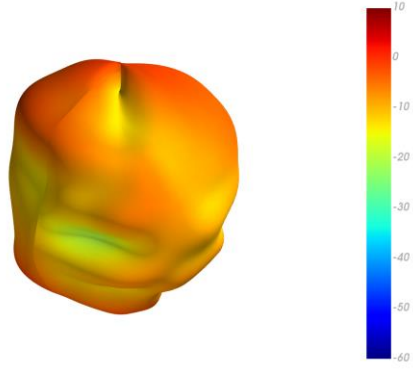

### XY Plane

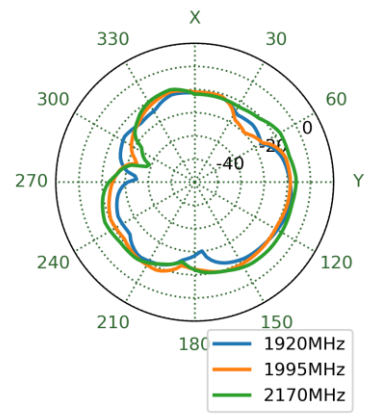

### XZ Plane

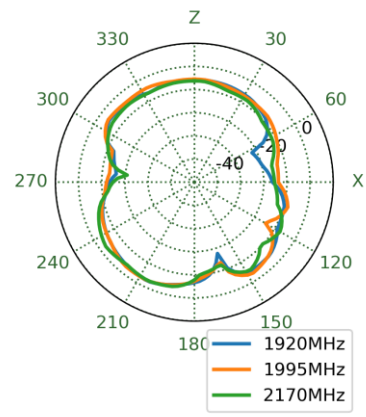

### YZ Plane

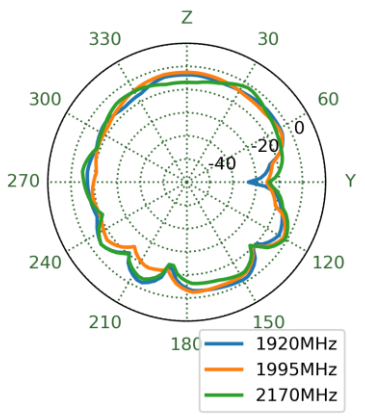

## 2570MHz

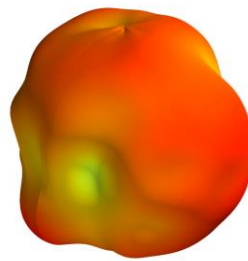

### XY Plane

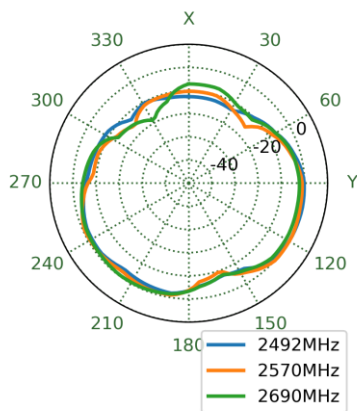

### XZ Plane

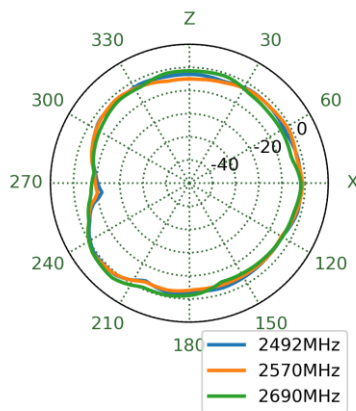

### YZ Plane

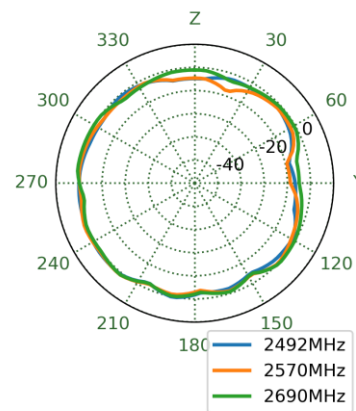

## 3500MHz

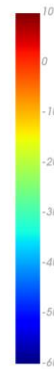
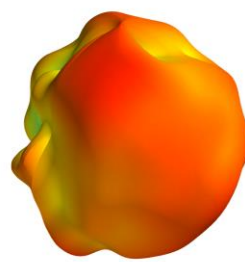

### XY Plane

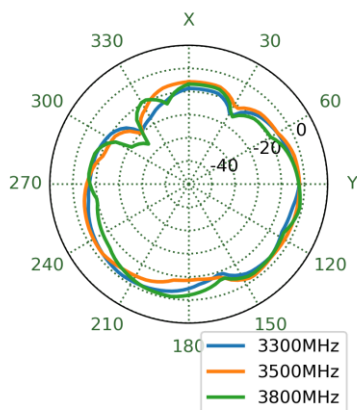

### XZ Plane

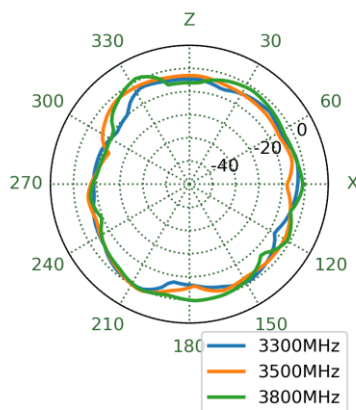

### YZ Plane

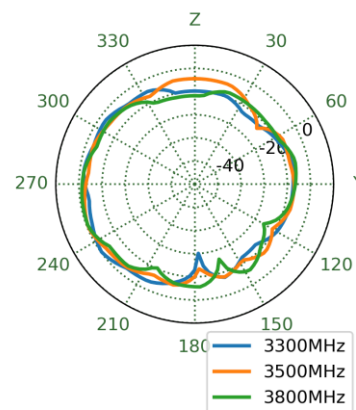

5.3 5G/4G 2 3D and 2D Radiation Patterns

1475MHz

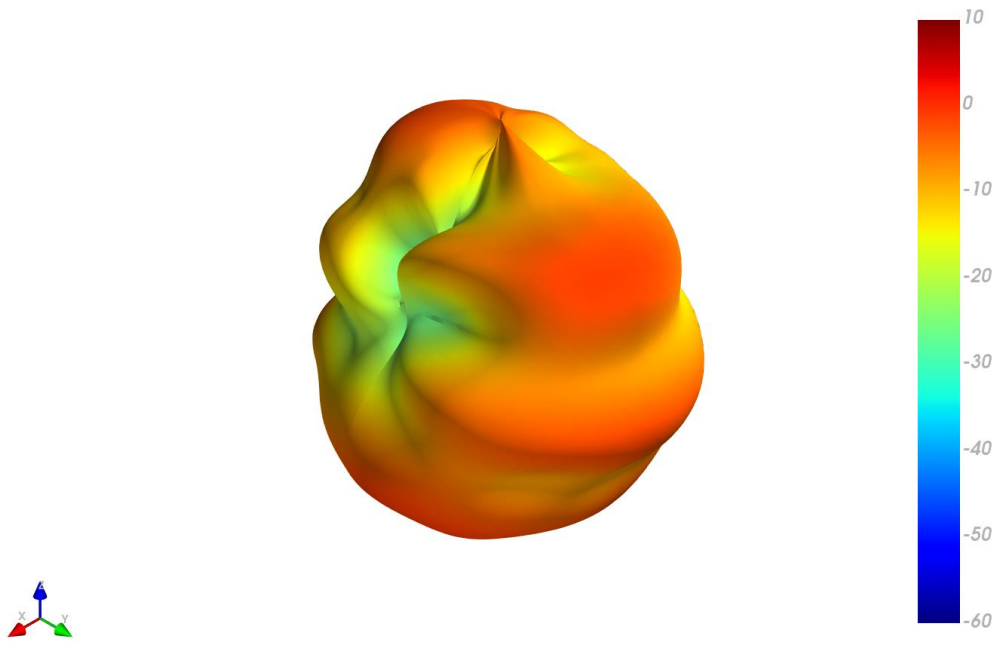

XY Plane

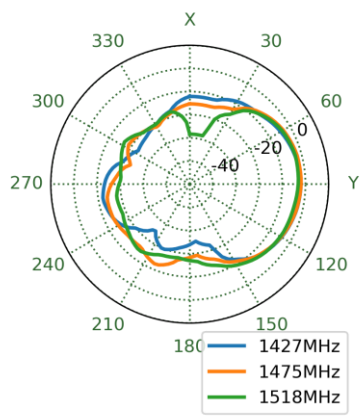

XZ Plane

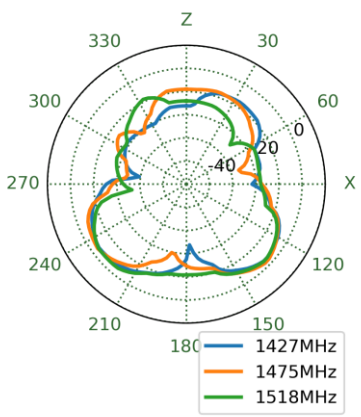

YZ Plane

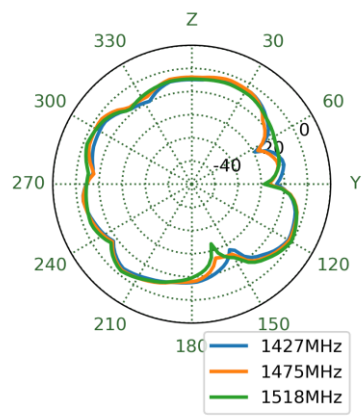

## 1770MHz

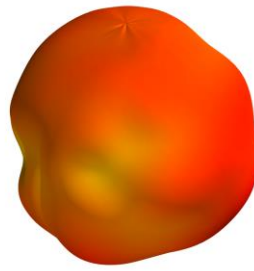

### XY Plane

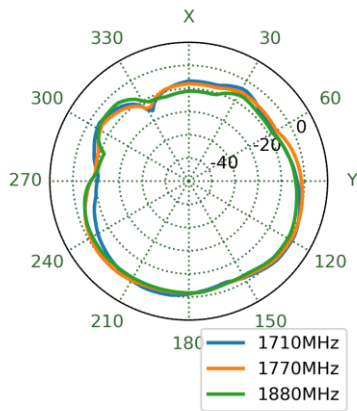

### XZ Plane

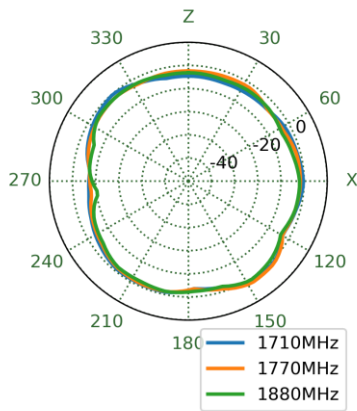

### YZ Plane

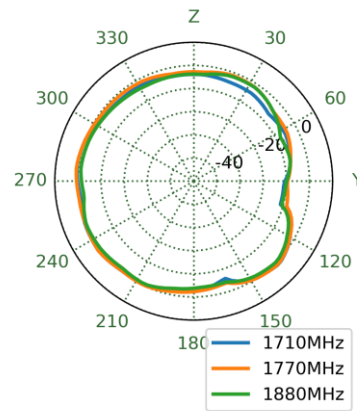

## 1910MHz

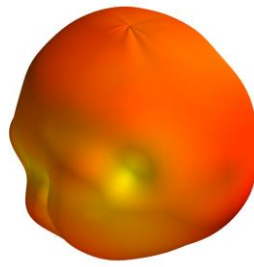

### XY Plane

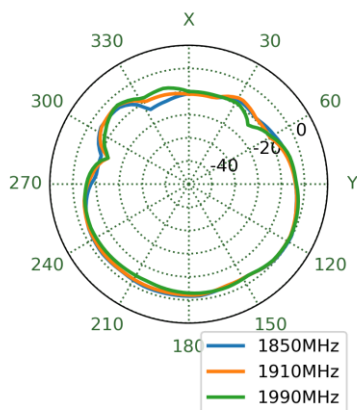

### XZ Plane

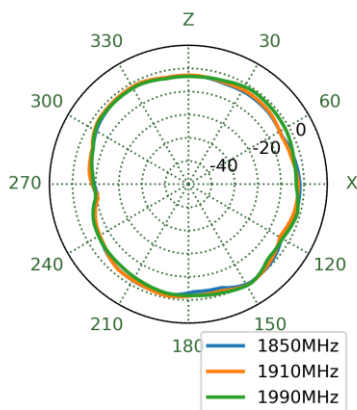

### YZ Plane

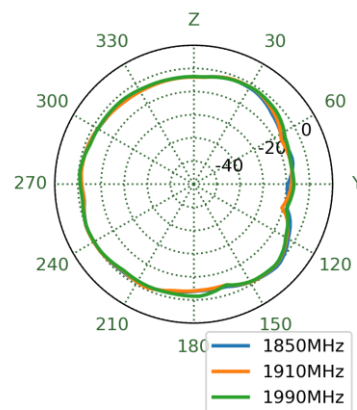

1995MHz

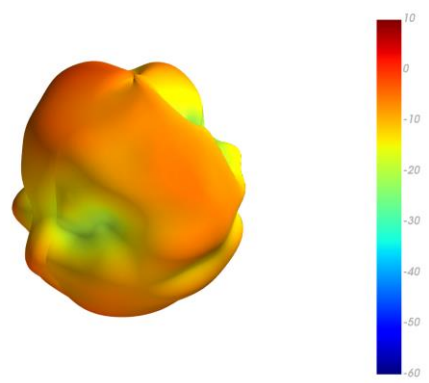

XY Plane

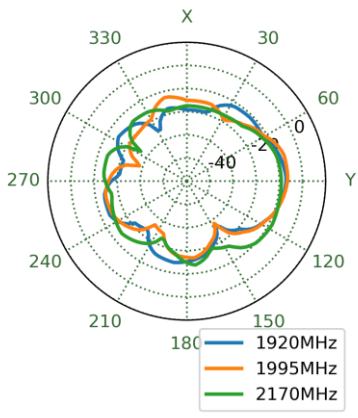

XZ Plane

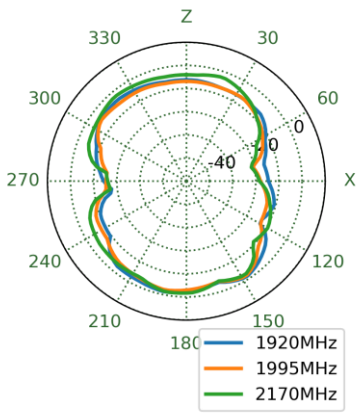

YZ Plane

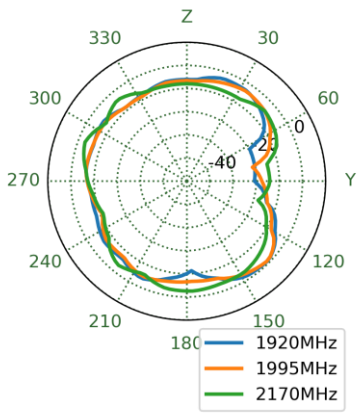

2570MHz

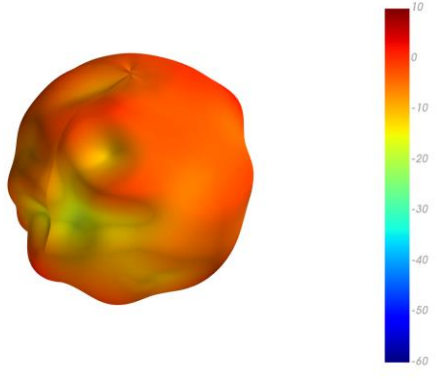

XY Plane

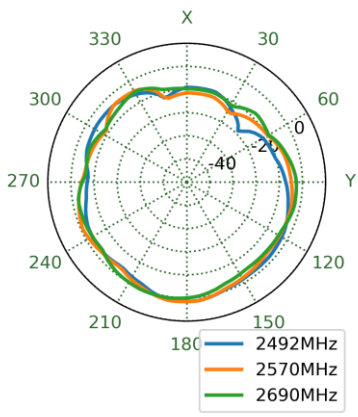

XZ Plane

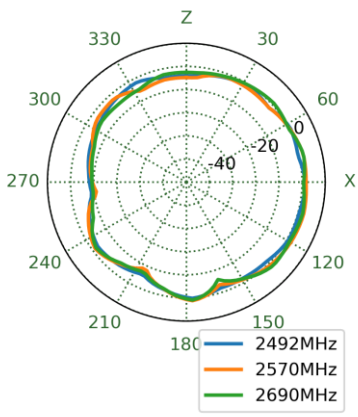

YZ Plane

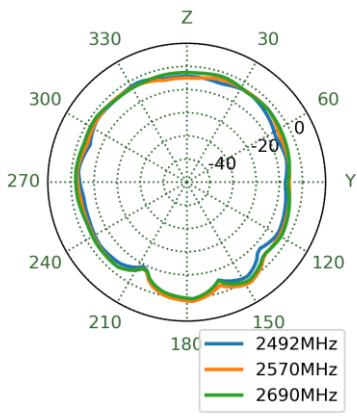

## 5.4 5G/4G 3 3D and 2D Radiation Patterns

3500MHz

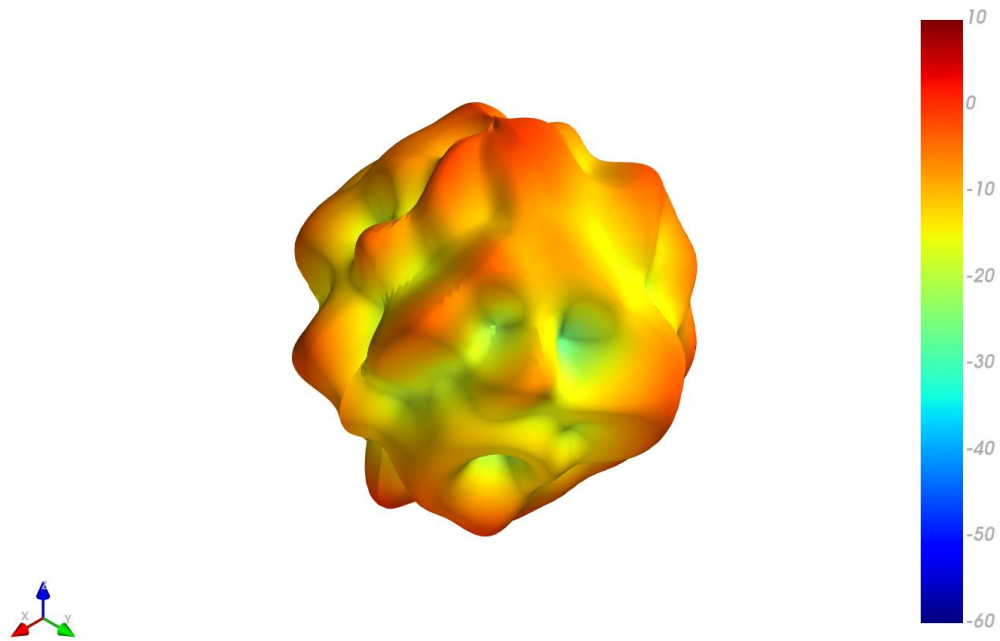

XY Plane

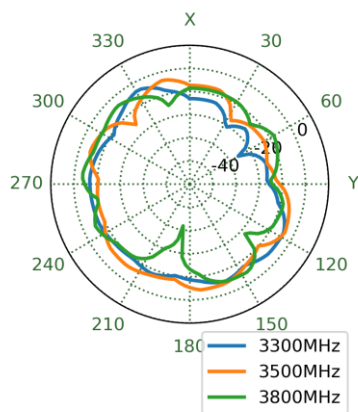

XZ Plane

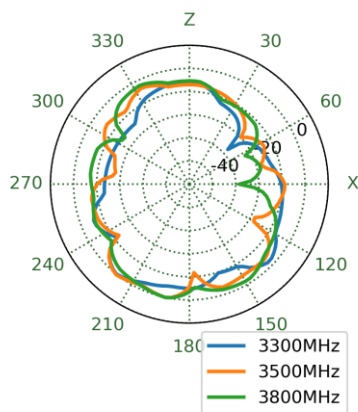

YZ Plane

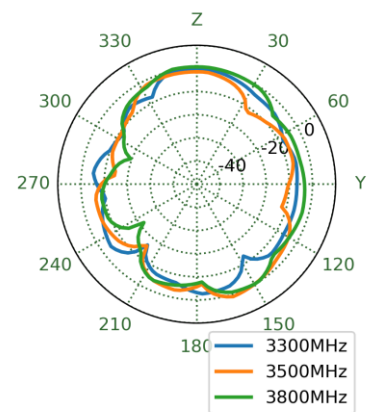

5570MHz

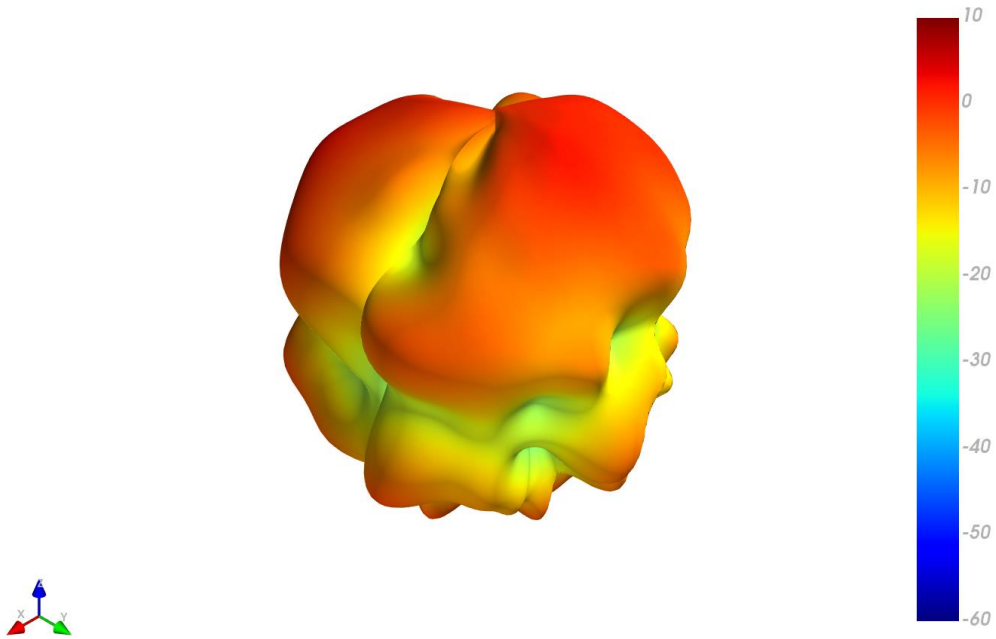

XY Plane

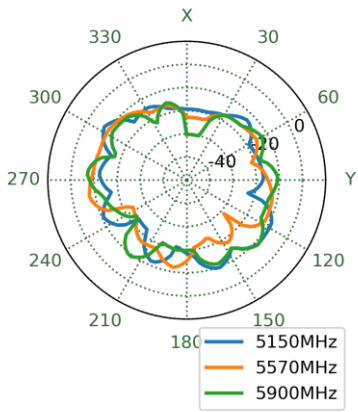

XZ Plane

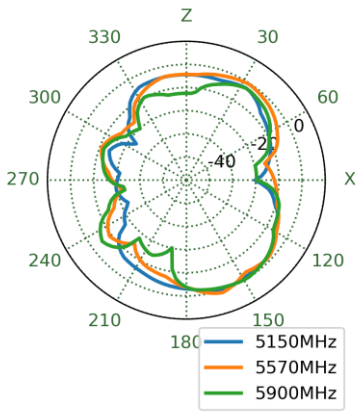

YZ Plane

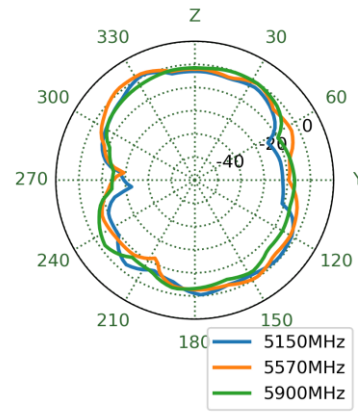



5.5 5G/4G 4 3D and 2D Radiation Patterns

663MHz

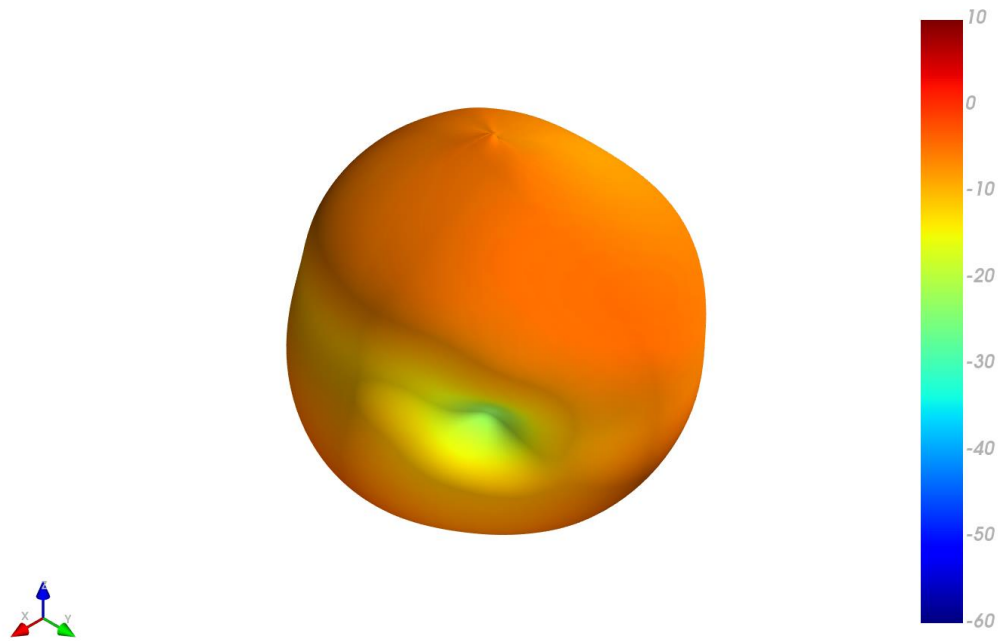

XY Plane XZ Plane YZ Plane

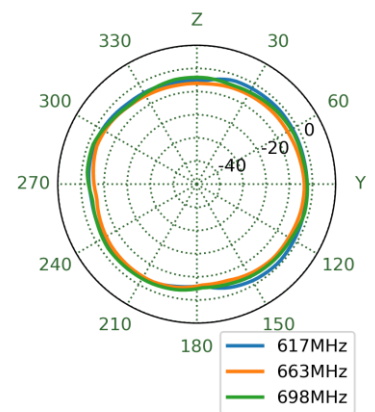
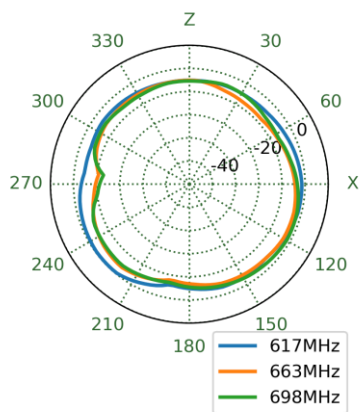
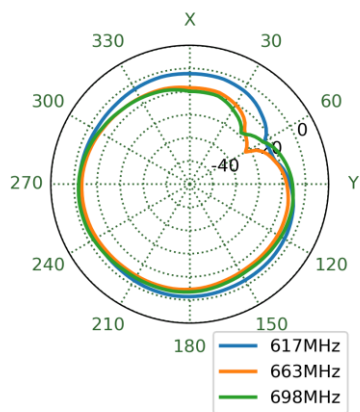

751MHz

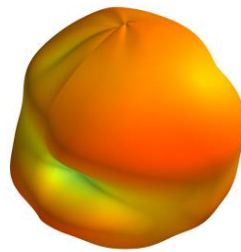

XY Plane

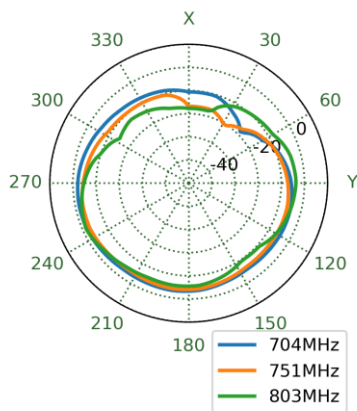

XZ Plane

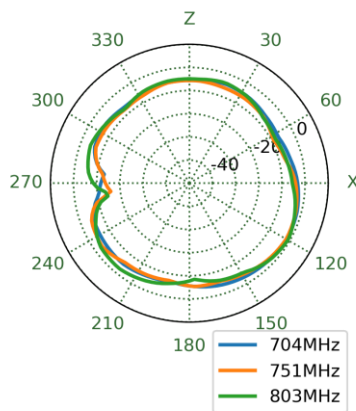

YZ Plane

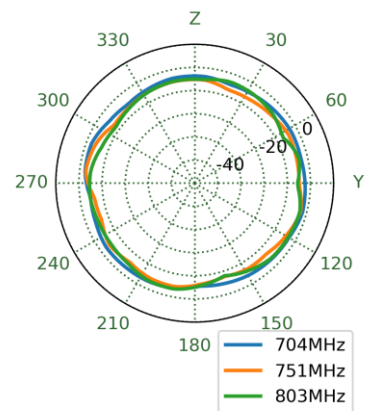

860MHz

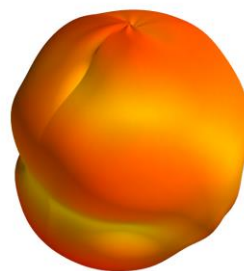

XY Plane

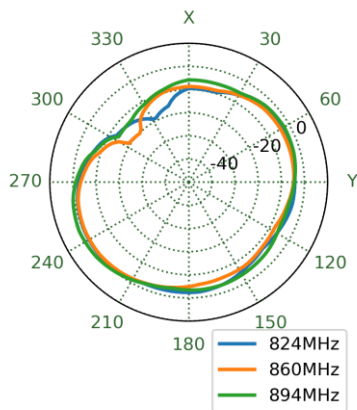

XZ Plane

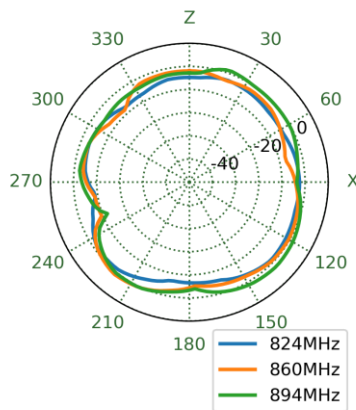

YZ Plane

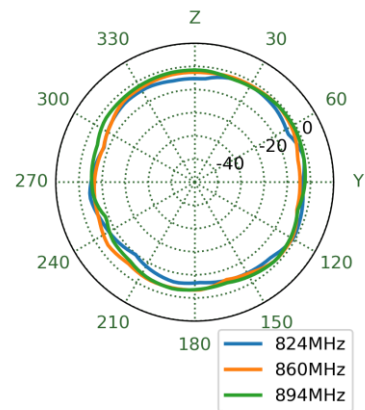

915MHz

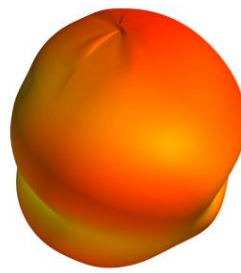

XY Plane

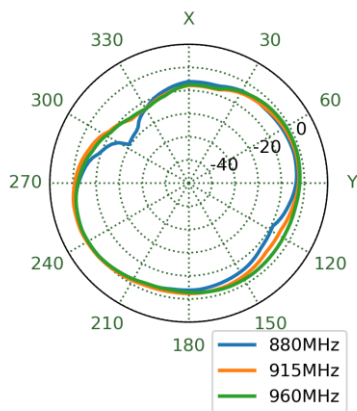

XZ Plane

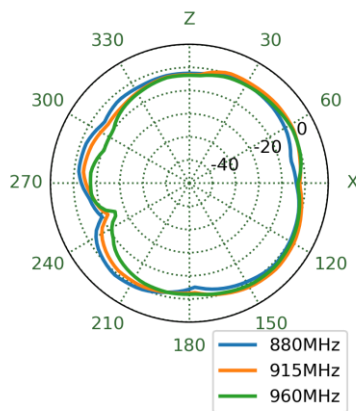

YZ Plane

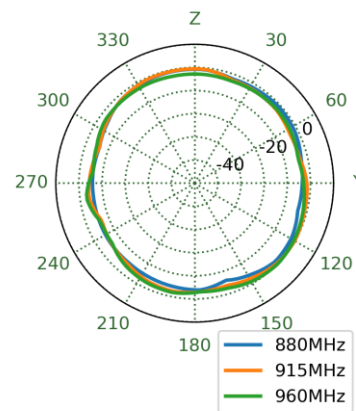

1475MHz

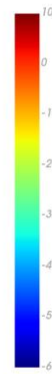
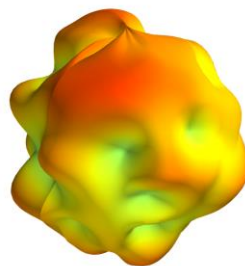

XY Plane

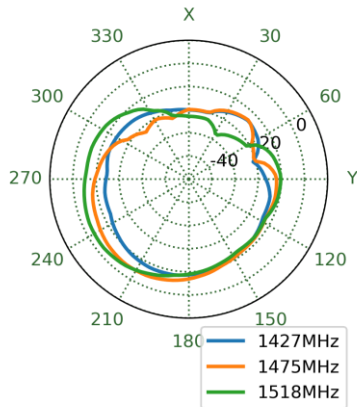

XZ Plane

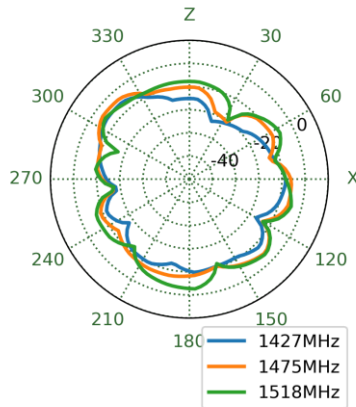

YZ Plane

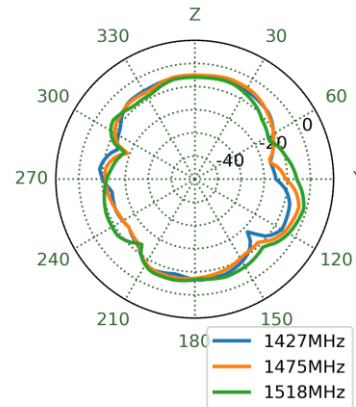

## 1770MHz

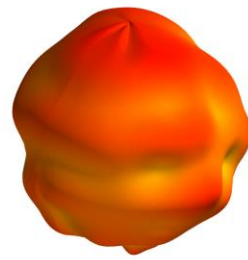

### XY Plane

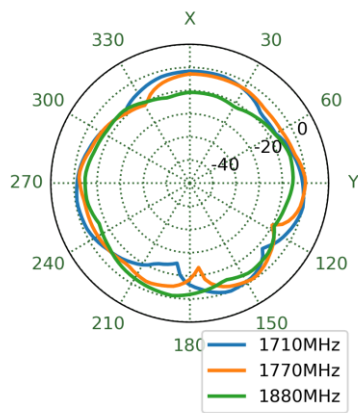

### XZ Plane

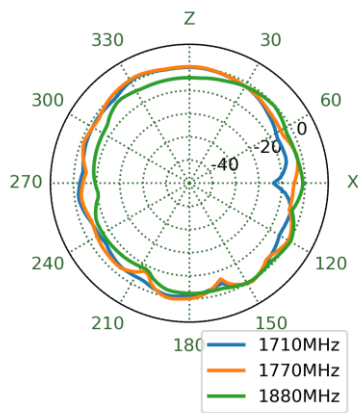

### YZ Plane

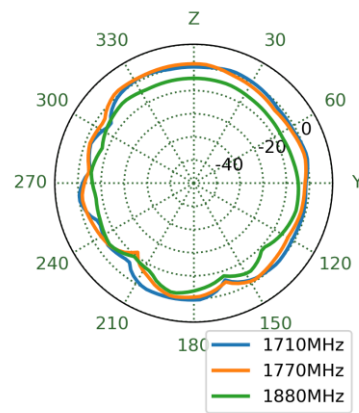

## 1910MHz

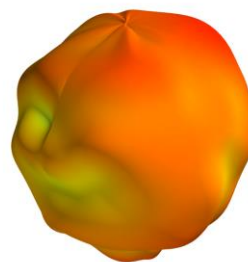

### XY Plane

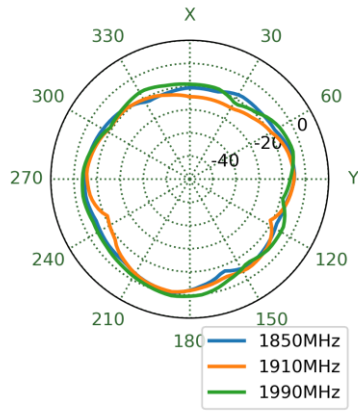

### XZ Plane

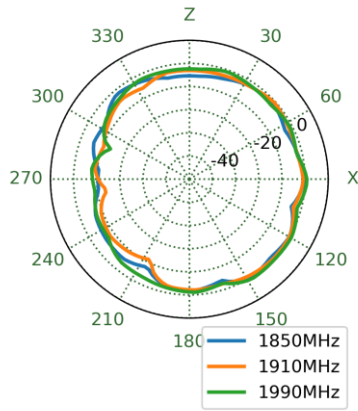

### YZ Plane

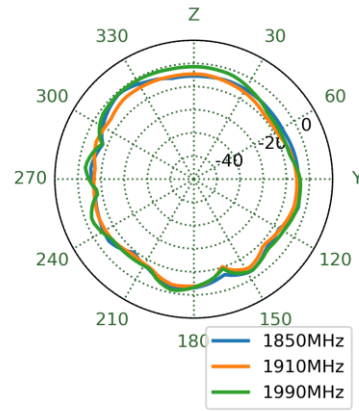

1995MHz

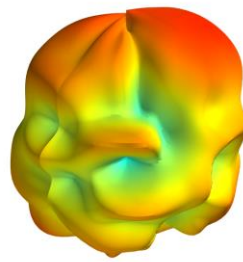

XY Plane

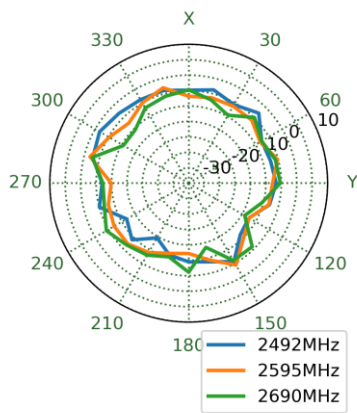

XZ Plane

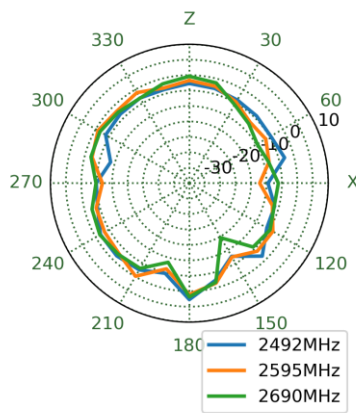

YZ Plane

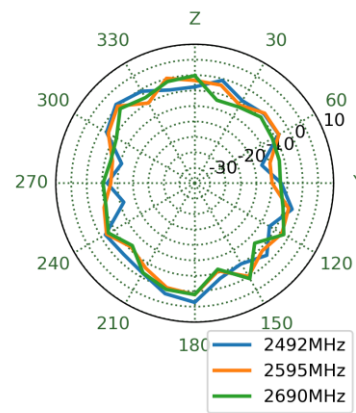

2570MHz

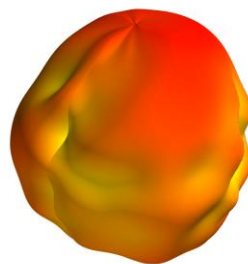

XY Plane

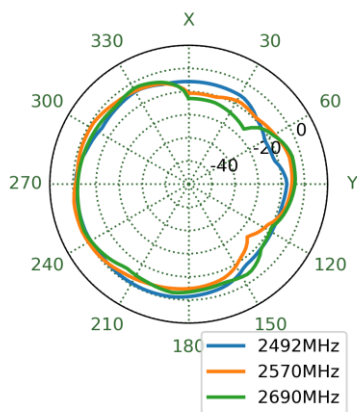

XZ Plane

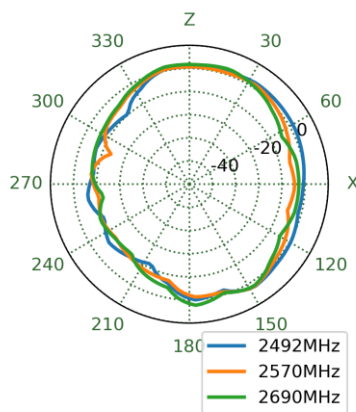

YZ Plane

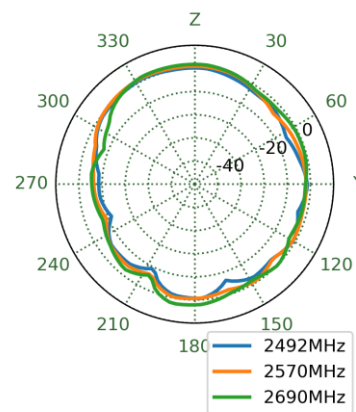

## 3500MHz

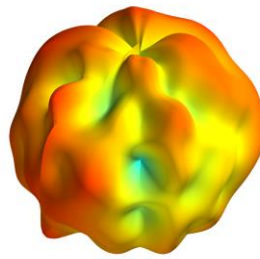

### XY Plane

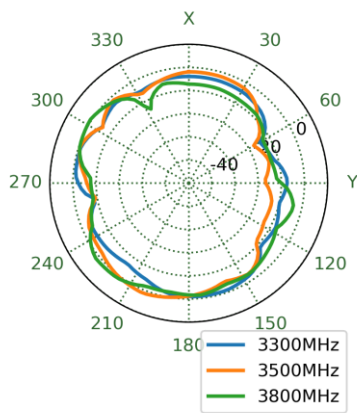

### XZ Plane

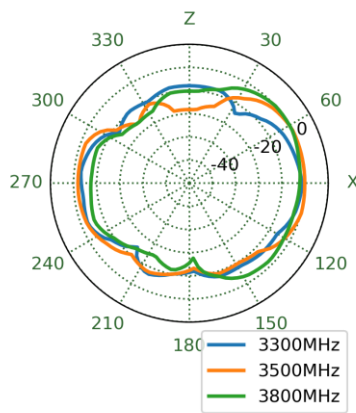

### YZ Plane

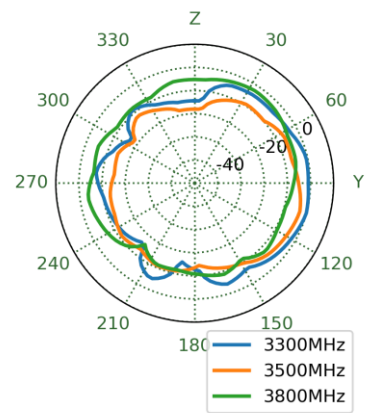

## 5570MHz

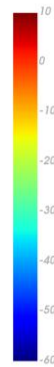
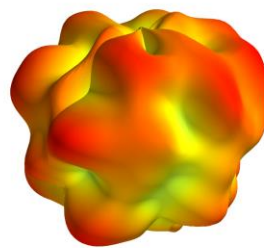

### XY Plane

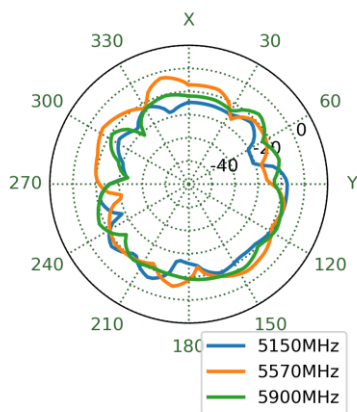

### XZ Plane

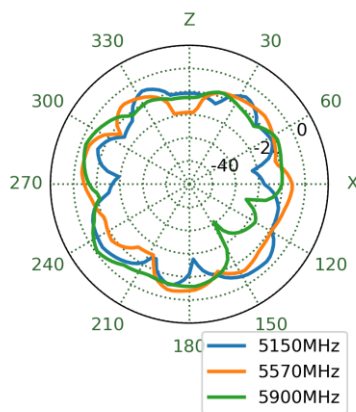

### YZ Plane

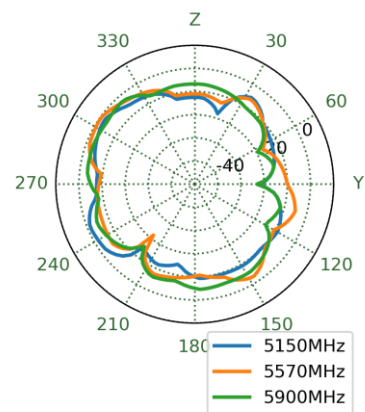

5.6 5G/4G 5 3D and 2D Radiation Patterns

663MHz

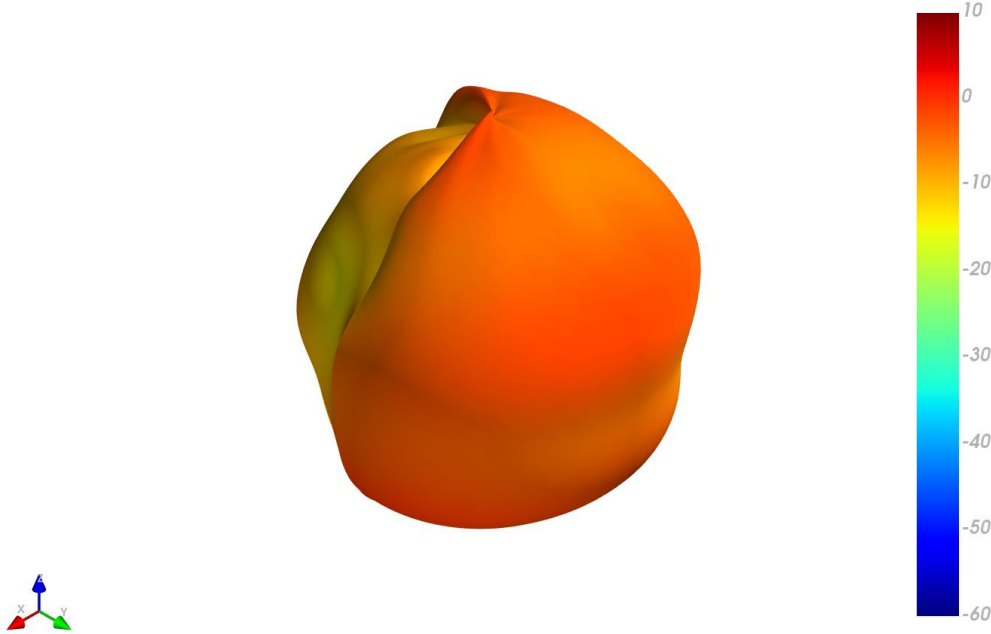

XY Plane

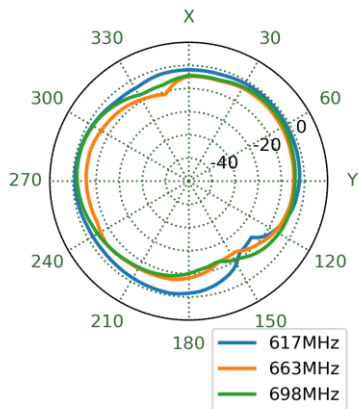

XZ Plane

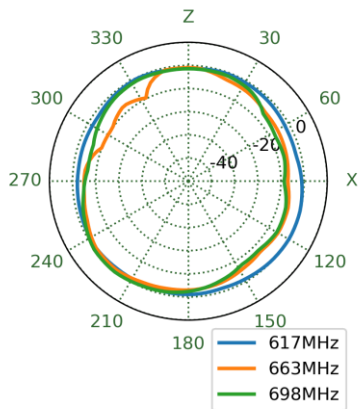

YZ Plane

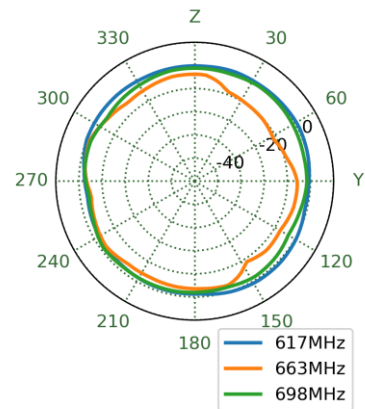

751MHz

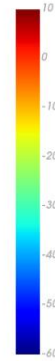
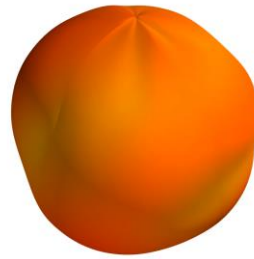

XY Plane

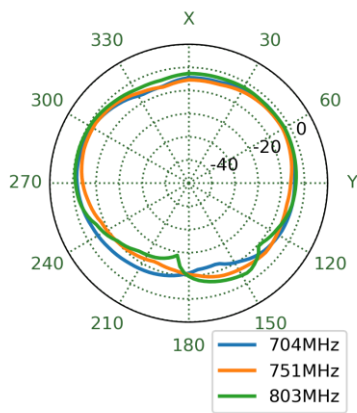

XZ Plane

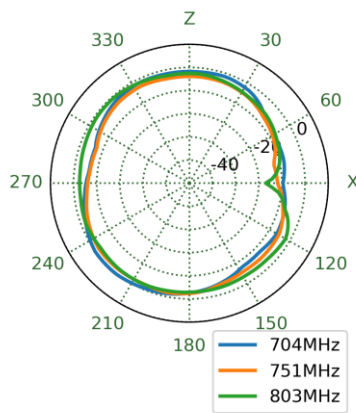

YZ Plane

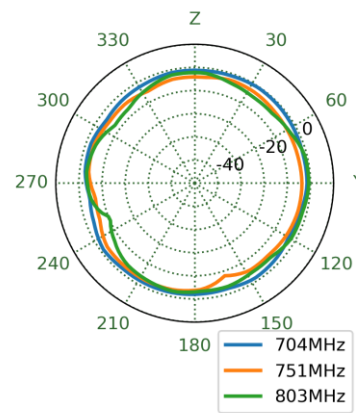

860MHz

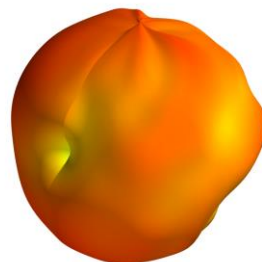

XY Plane

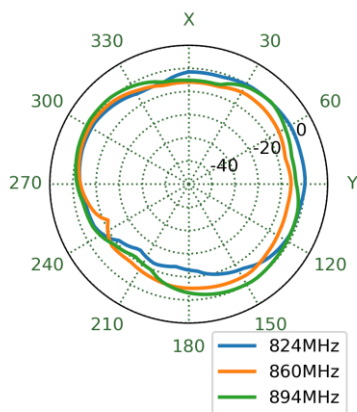

XZ Plane

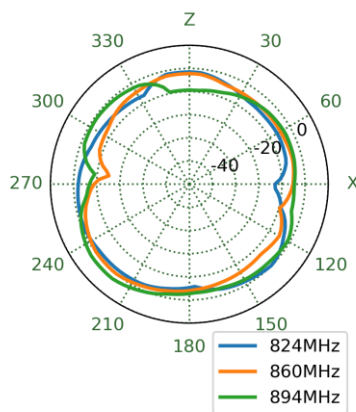

YZ Plane

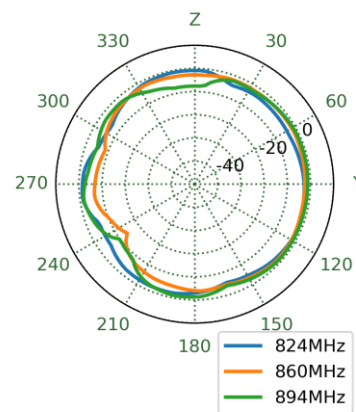



915MHz

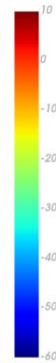
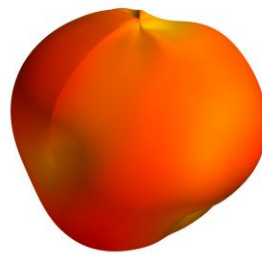

XY Plane

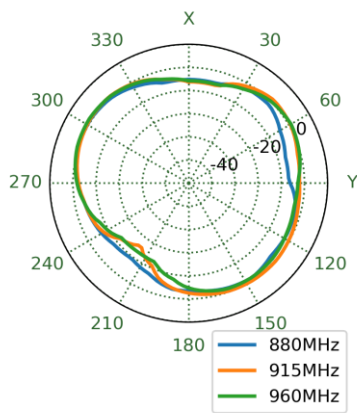

XZ Plane

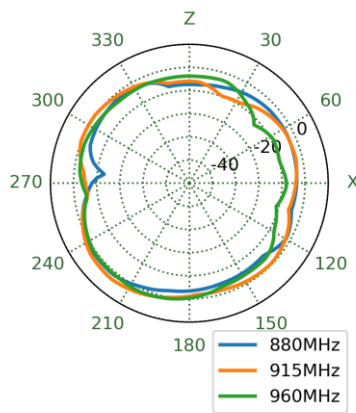

YZ Plane

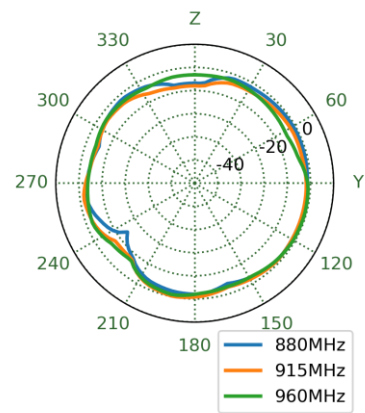

1475MHz

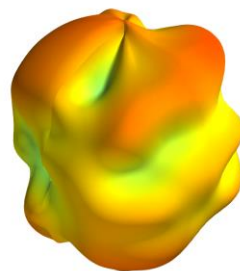

XY Plane

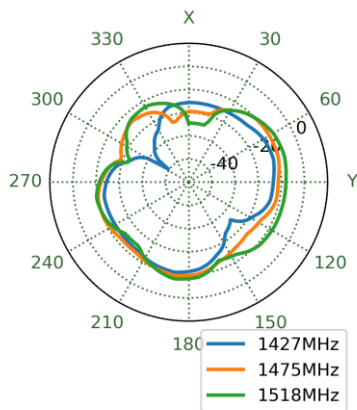

XZ Plane

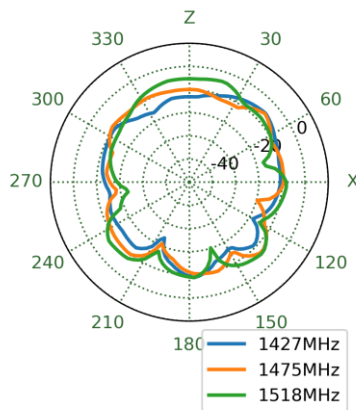

YZ Plane

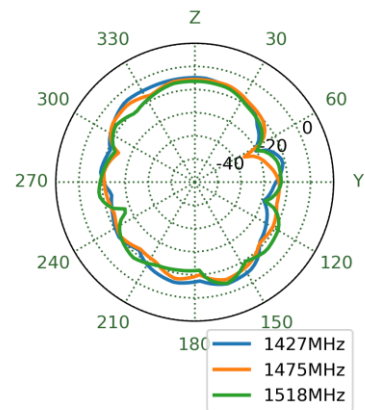

## 1770MHz

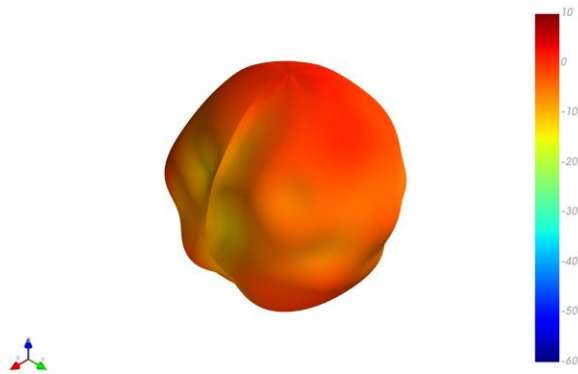

### XY Plane

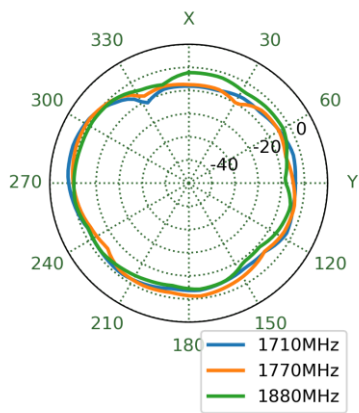

### XZ Plane

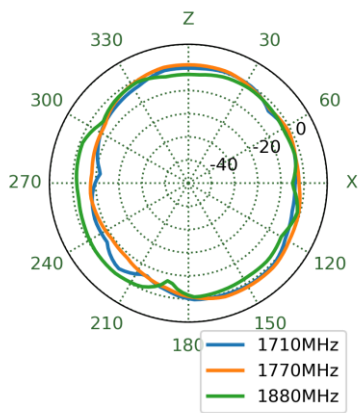

### YZ Plane

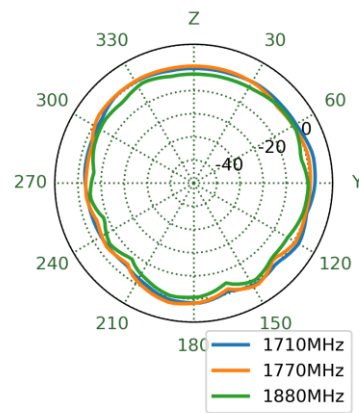

## 1910MHz

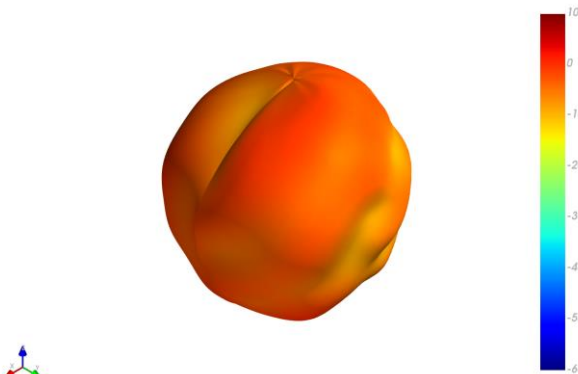

### XY Plane

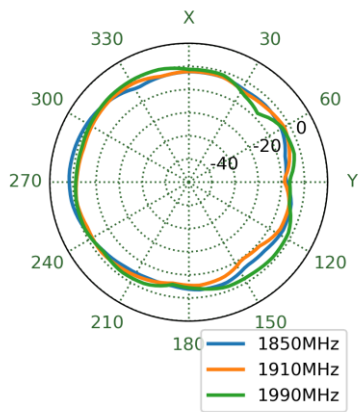

### XZ Plane

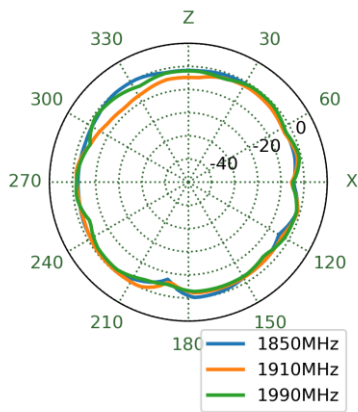

### YZ Plane

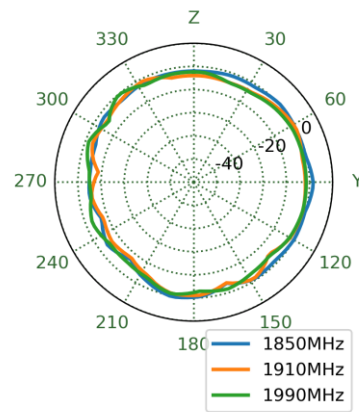

## 1995MHz

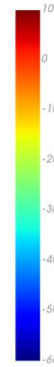
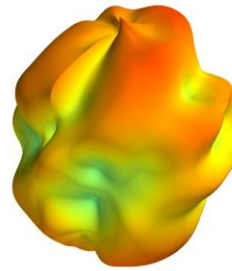

### XY Plane

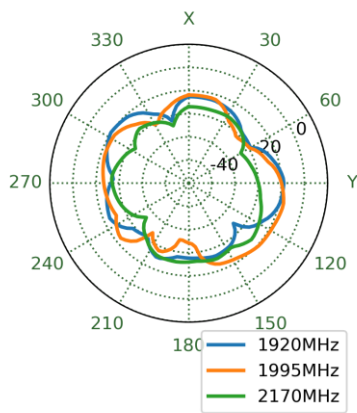

### XZ Plane

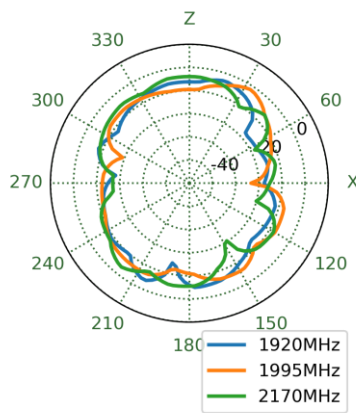

### YZ Plane

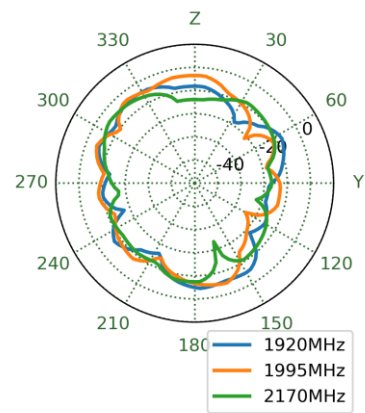

## 2570MHz

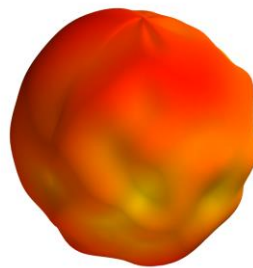

### XY Plane

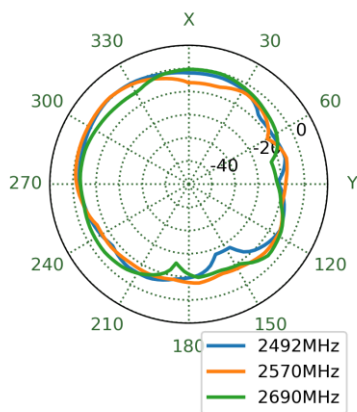

### XZ Plane

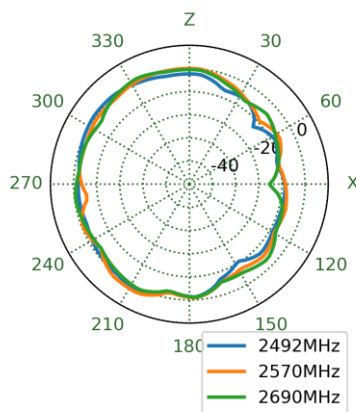

### YZ Plane

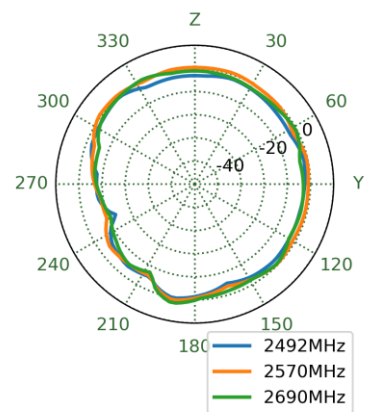

## 3500MHz

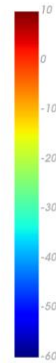
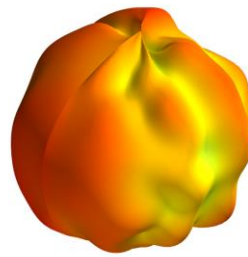

### XY Plane

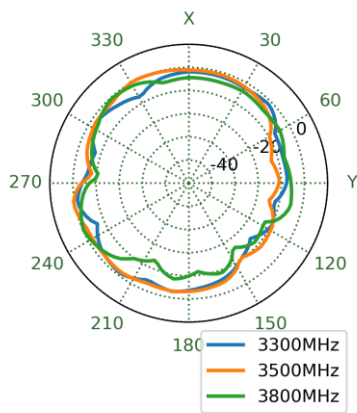

### XZ Plane

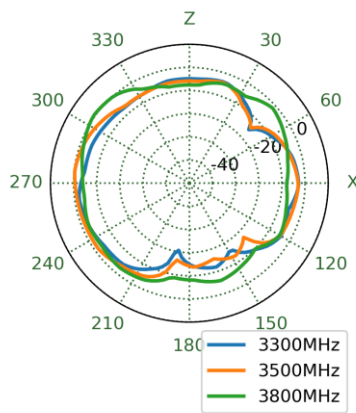

### YZ Plane

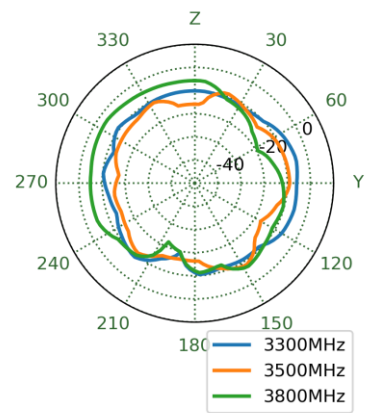

## 5570MHz

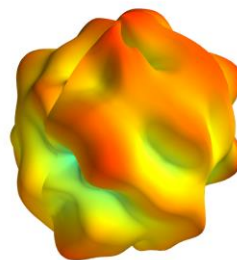

### XY Plane

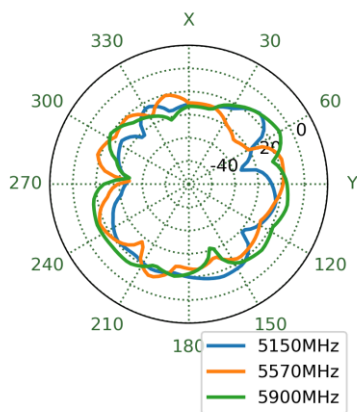

### XZ Plane

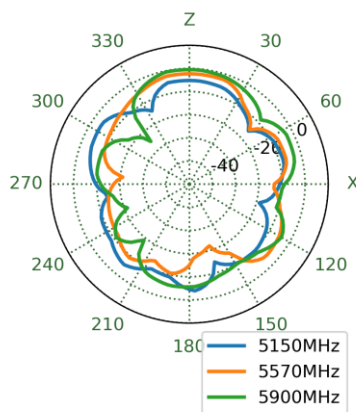

### YZ Plane

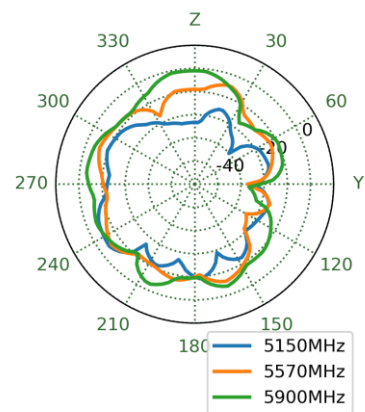

5.7 5G/4G 6 3D and 2D Radiation Patterns

3500MHz

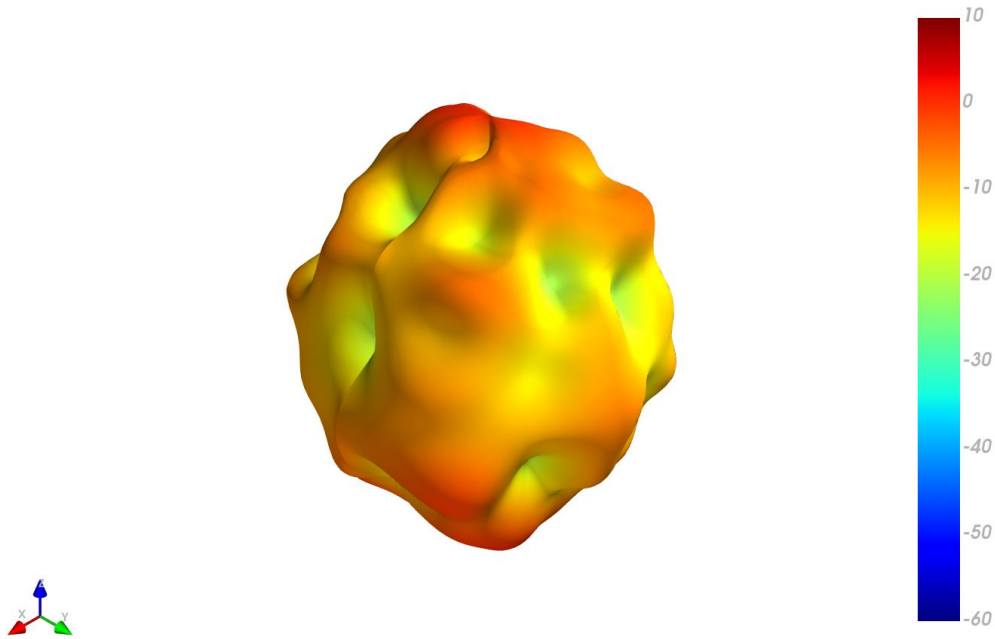

XY Plane      XZ Plane      YZ Plane

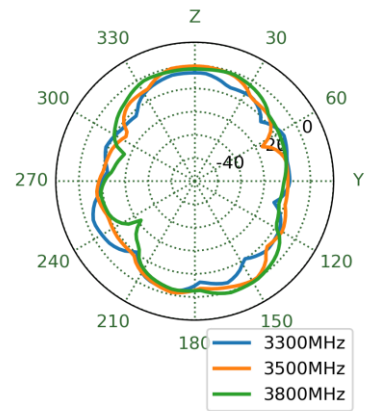
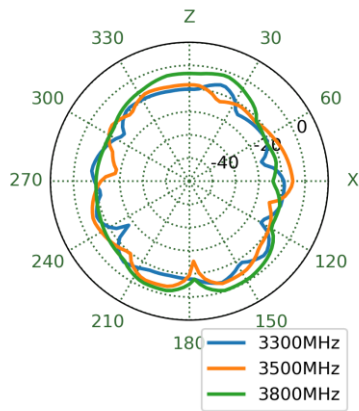
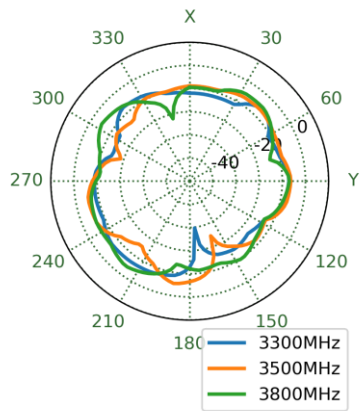

5570MHz

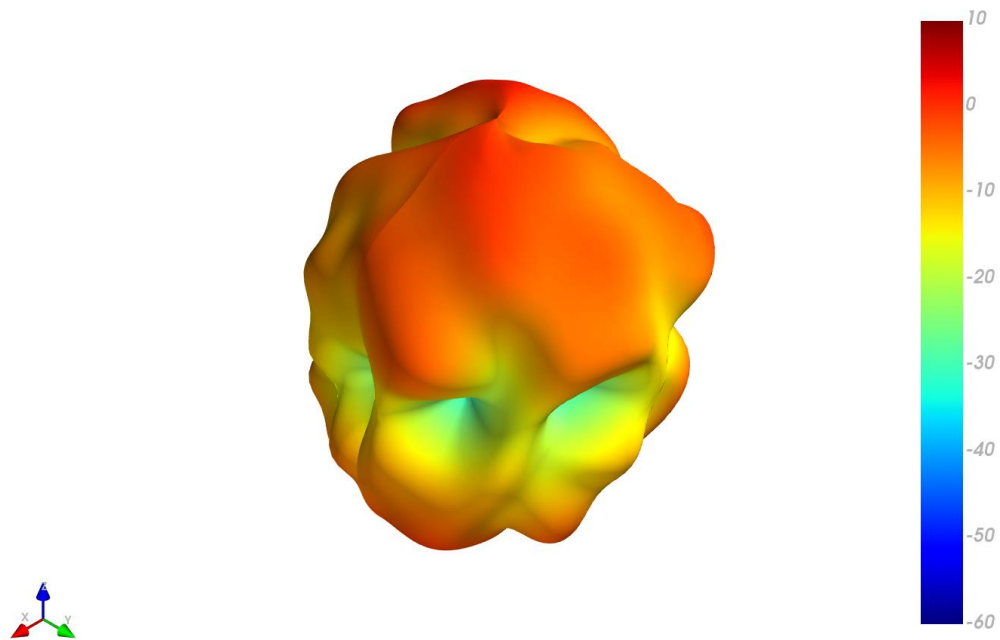

XY Plane

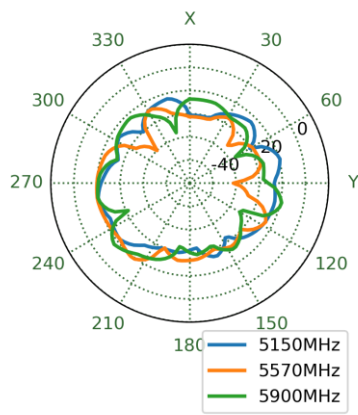

XZ Plane

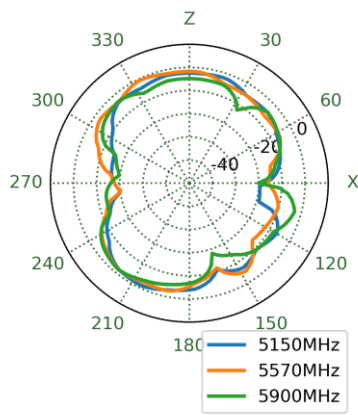

YZ Plane

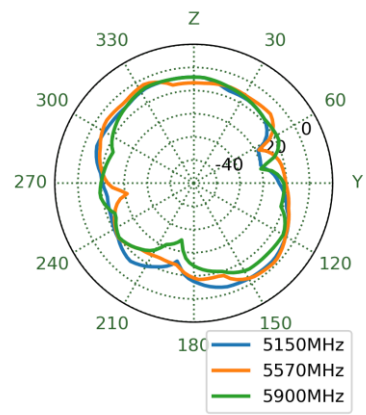

5.8 5G/4G 7 3D and 2D Radiation Patterns

1475MHz

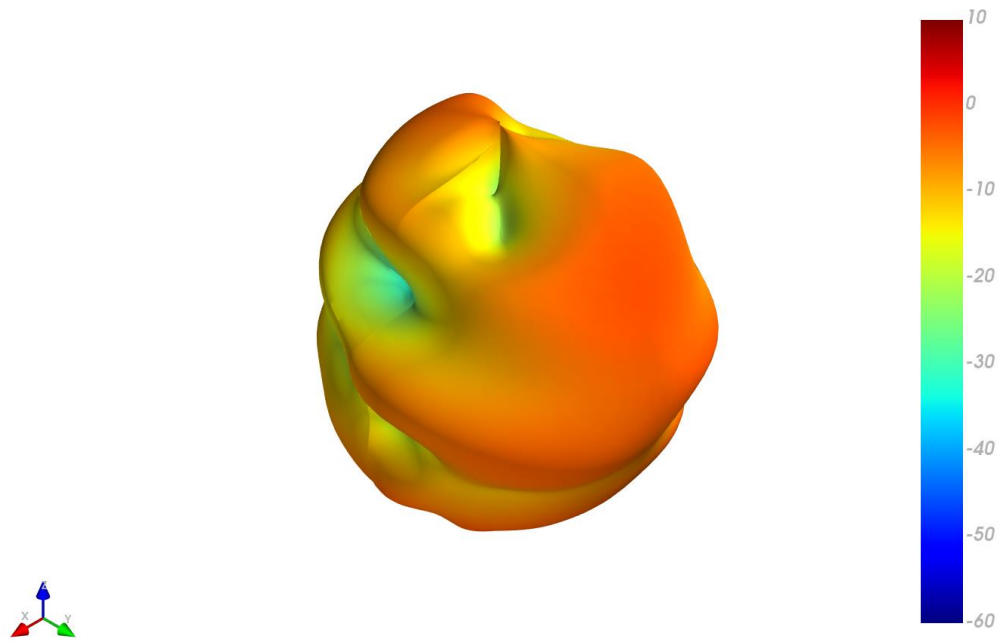

XY Plane

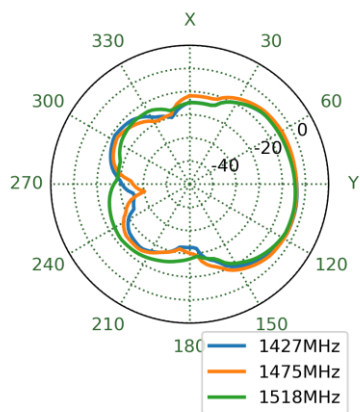

XZ Plane

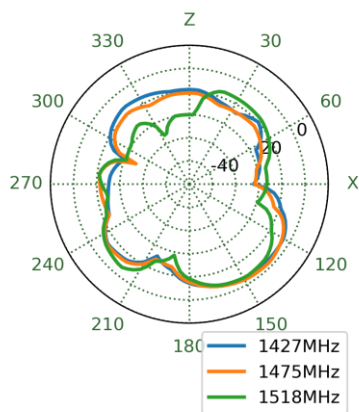

YZ Plane

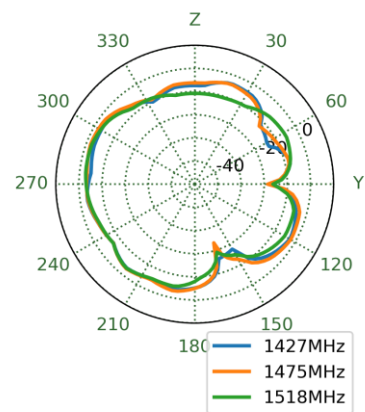

1770MHz



XY Plane      XZ Plane      YZ Plane

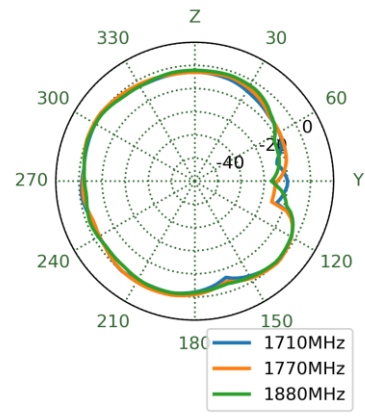
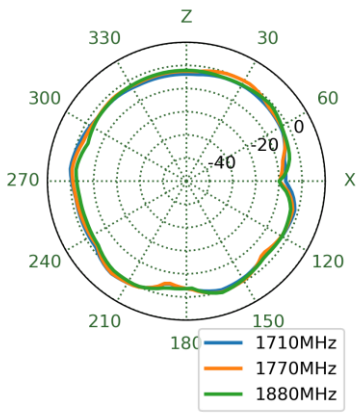
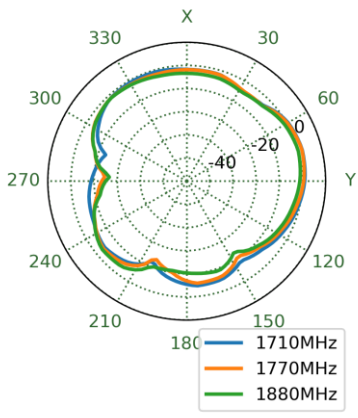

1910MHz

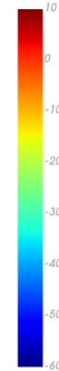
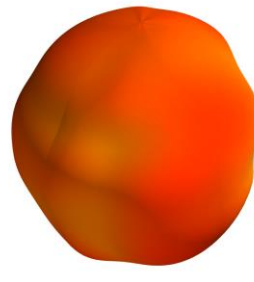

XY Plane      XZ Plane      YZ Plane

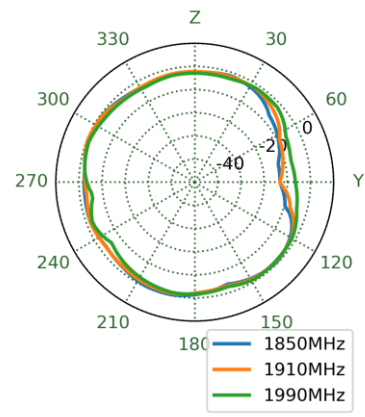
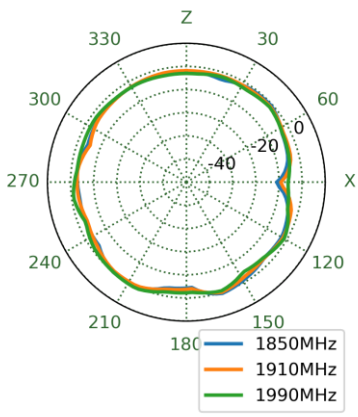
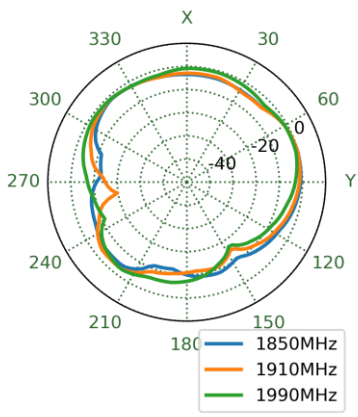



## 1995MHz

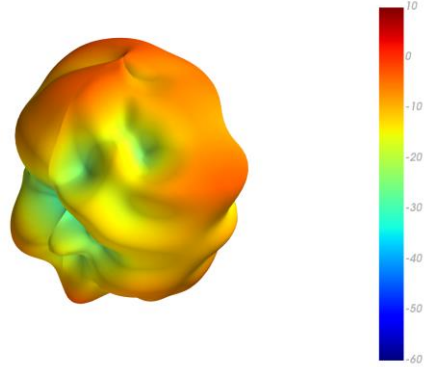

### XY Plane

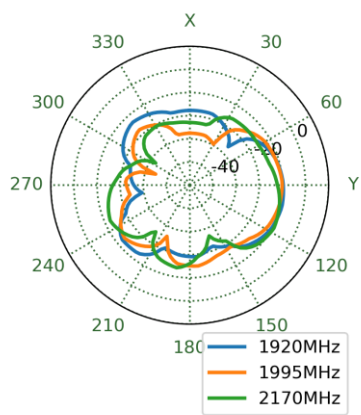

### XZ Plane

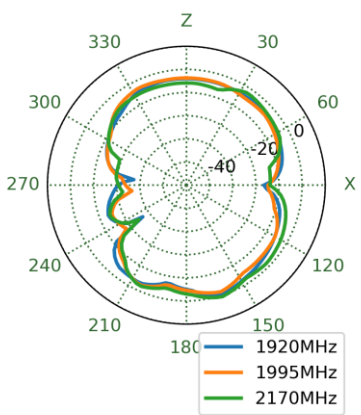

### YZ Plane

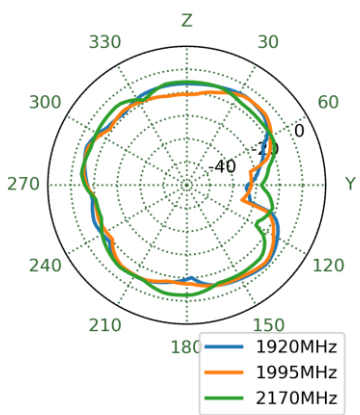

## 2570MHz

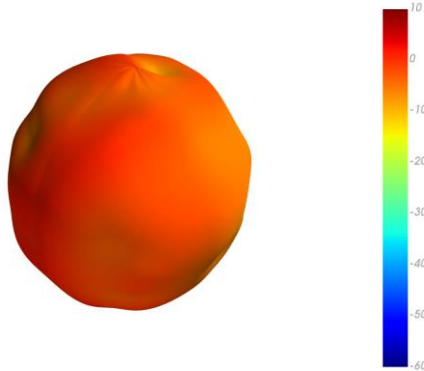

### XY Plane

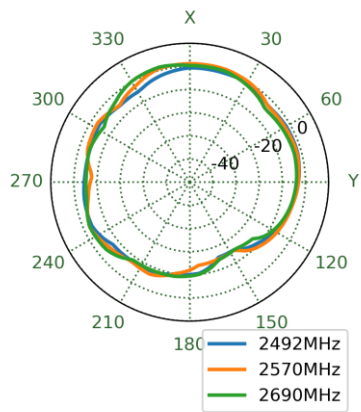

### XZ Plane

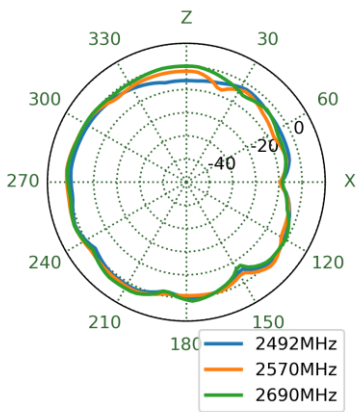

### YZ Plane

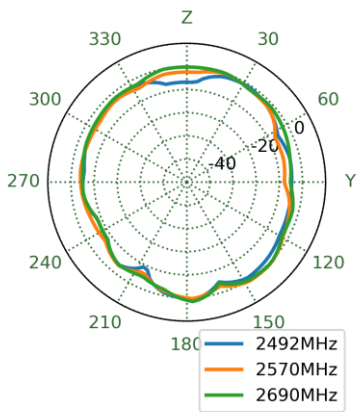

5.9 5G/4G 8 3D and 2D Radiation Patterns

1770MHz

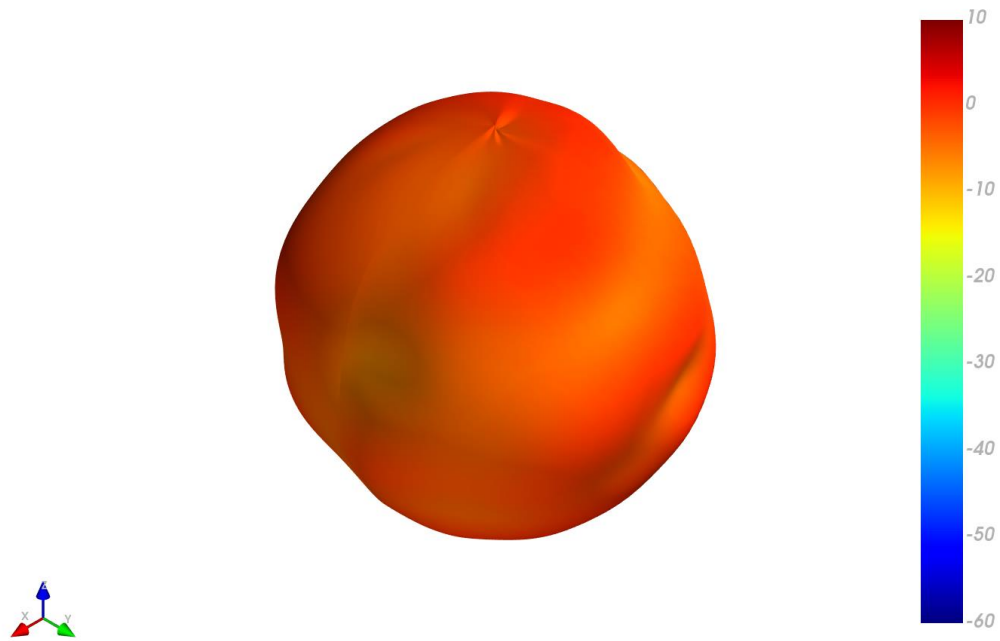

XY Plane

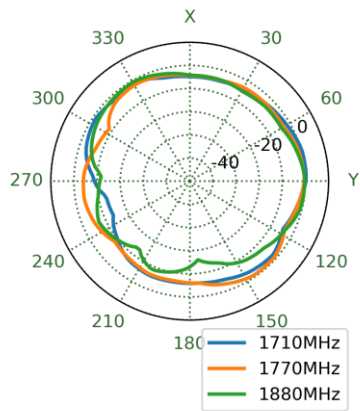

XZ Plane

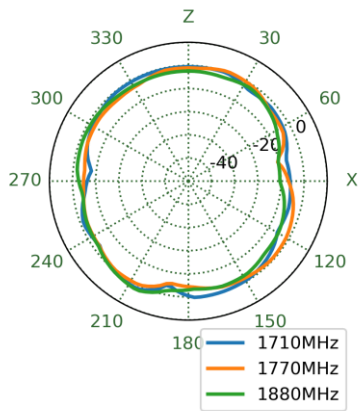

YZ Plane

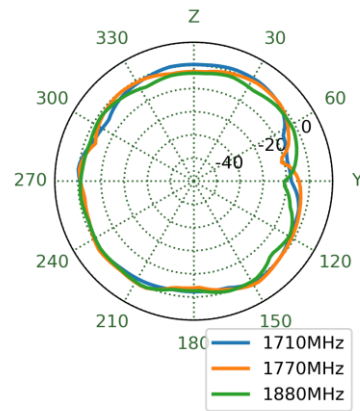

1910MHz

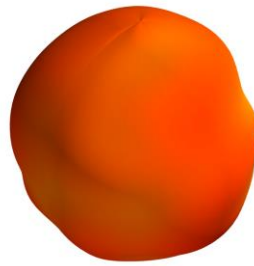

XY Plane

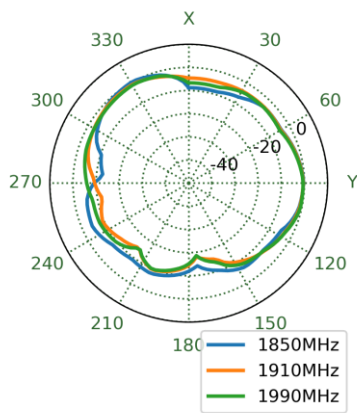

XZ Plane

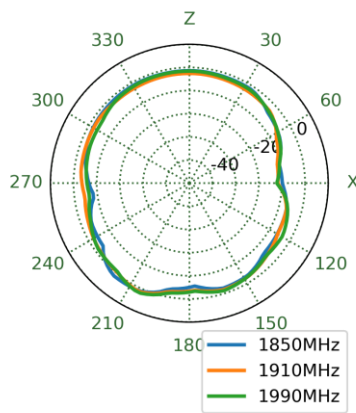

YZ Plane

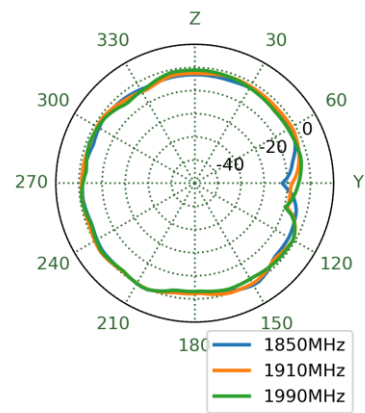

1995MHz

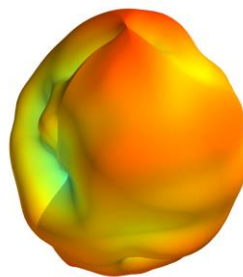

XY Plane

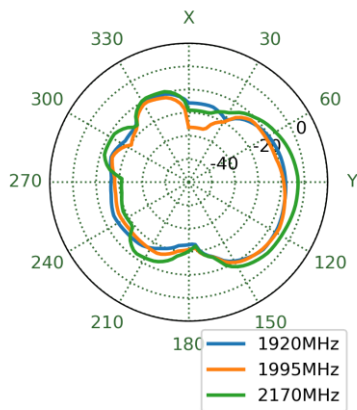

XZ Plane

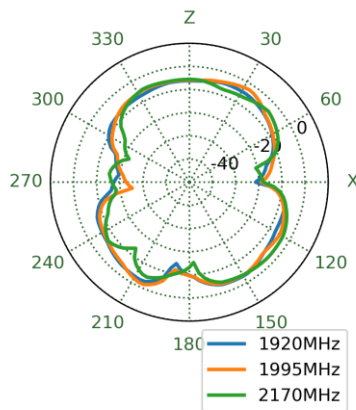

YZ Plane

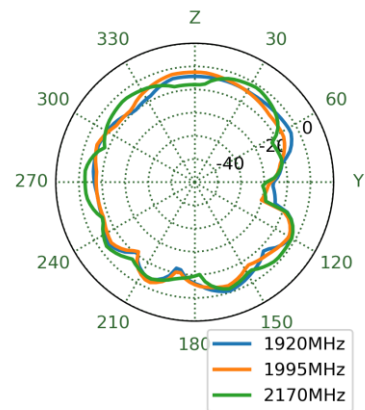

2570MHz

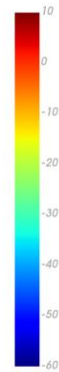
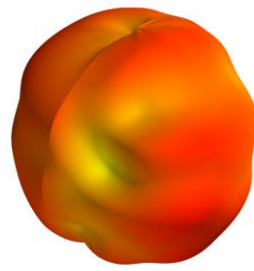

XY Plane

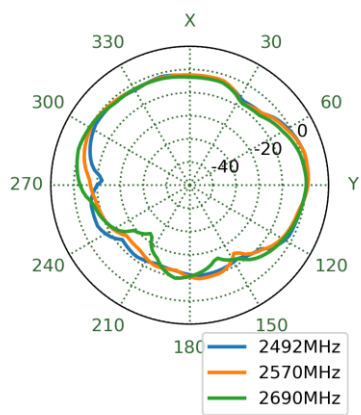

XZ Plane

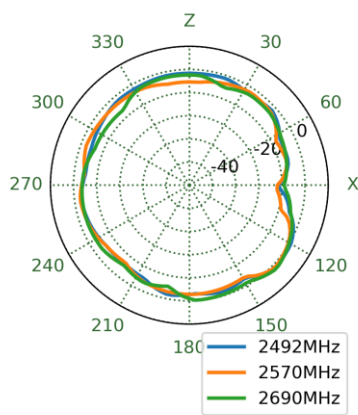

YZ Plane

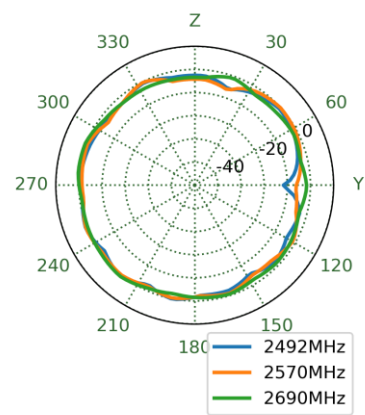

3500MHz

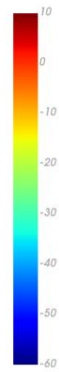
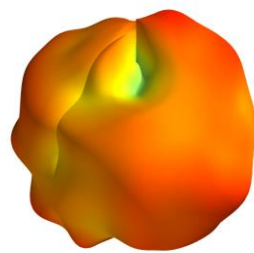

XY Plane

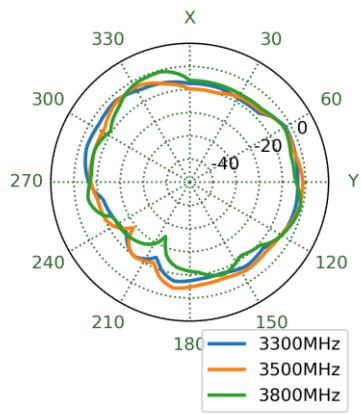

XZ Plane

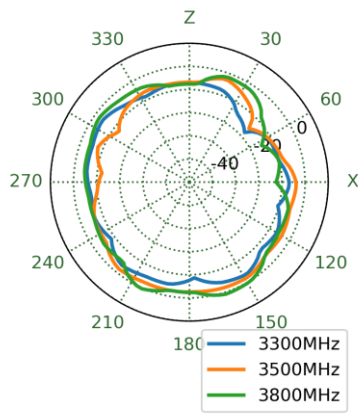

YZ Plane

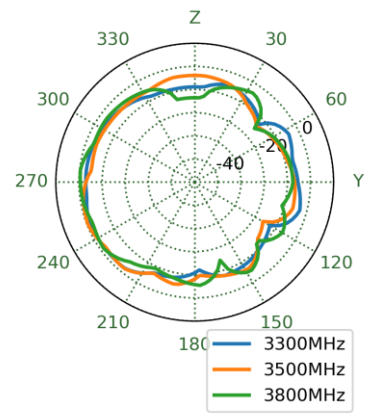

5.10 5G/4G 8 3D and 2D Radiation Patterns

Test Setup

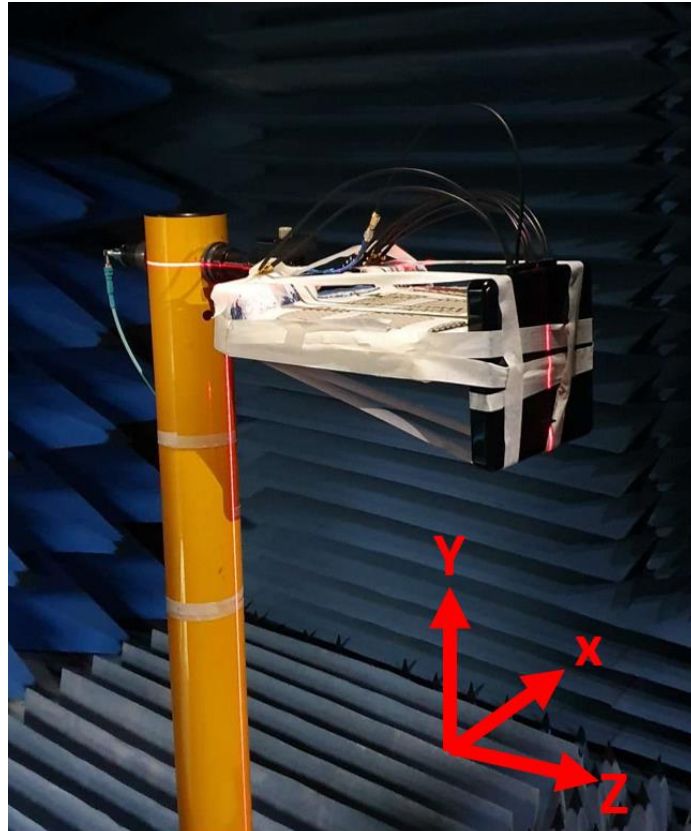

# 6. Mechanical Drawing (Units: mm)

ISO NO.: EDW-21-8-0361

STATE: Release

NOTES:

- All material must be RoHS compliant.
- Color Codes: PANTONE Black / Plastics Color Q728-1-1.
- Finish: Mirror Polish / SPI A-2.
- Deburring: Less than 0.02mm.
- No gate, parting line and any other tooling marks on appearance of product.
- Once product have any crack/break/thread damage or any structural tooling issue, molding supplier need to correct the issue unconditionally.
- Use this drawing together with the corresponding 3D CAD database file to fully describe the part.
- The connector orientation has a fixed position to the antenna as per drawing.
- Double Sided Adhesive Area :

REV	ZONE	DESCRIPTION	ENG	APPROVED	DATE
001	All	Initial design	Aron Yan	Chozen	2021/08/17

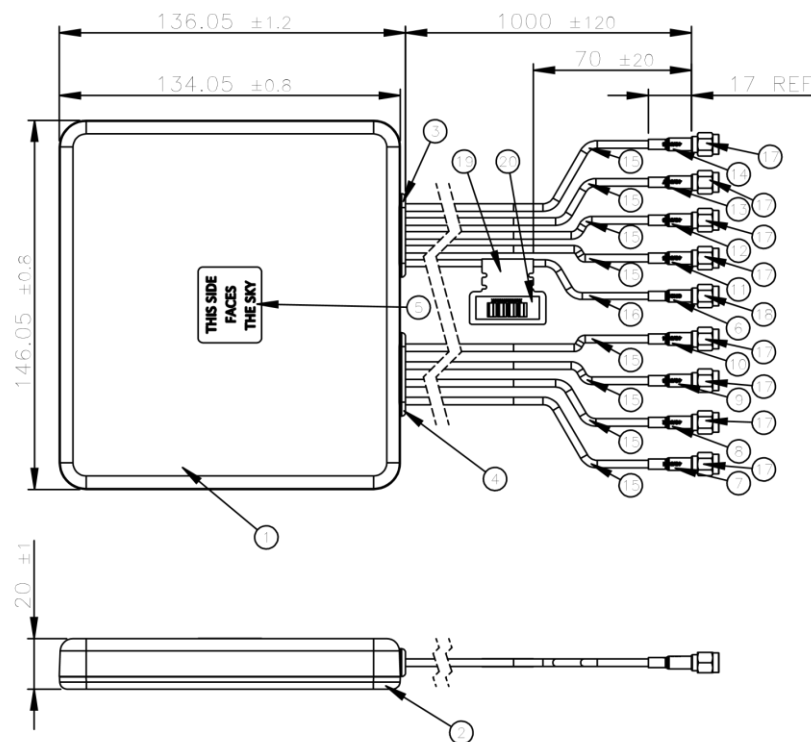

	Name	P/N	Material	Finish	QTY
1	Top housing	000116B000000A	ASA(PW-978B)	Black	1
2	Bottom housing	000116B010000A	ASA(PW-978B)	Black	1
3	Rubber (5 Holes)	000721A070000A	Silicone Rubber	Black	1
4	Rubber (4 Holes)	000721B000000A	Silicone Rubber	Black	1
5	Clear Label	001015H040000A	PET	Transparent	1
6	Heat Shrink Tube(GNSS)	001316C000000A	PE	Blue Tube/White Text	1
7	Heat Shrink Tube(4G/5G-1)	001319G000000A	PE	Red Tube/White Text	1
8	Heat Shrink Tube(4G/5G-2)	001319G010000A	PE	Red Tube/White Text	1
9	Heat Shrink Tube(4G/5G-3)	001319G020000A	PE	Red Tube/White Text	1
10	Heat Shrink Tube(4G/5G-4)	001319G030000A	PE	Red Tube/White Text	1
11	Heat Shrink Tube(4G/5G-5)	001319G040000A	PE	Red Tube/White Text	1
12	Heat Shrink Tube(4G/5G-6)	001319G110000A	PE	Red Tube/White Text	1
13	Heat Shrink Tube(4G/5G-7)	001321A000000A	PE	Red Tube/White Text	1
14	Heat Shrink Tube(4G/5G-8)	001321A010000A	PE	Red Tube/White Text	1
15	TGC-1.5DS Cable	301319I010000A	PE	Black	8
16	RG174 Cable	301315C000000A	PVC	Black	1
17	SMA(M) ST TCG 1.5DS	200221E000021A	Brass	Au Plated	8
18	SMA(M) ST RG174	200220C04001GA	Brass	Au Plated	1
19	Empty Label	001015G000000A	PEPA	White	1
20	Barcode Label	001015G010000A	PET	White	1
21	Double Sided Adhesive(Black Foam)	001019C010000A	CR4305+3M9448HK	White Liner	1

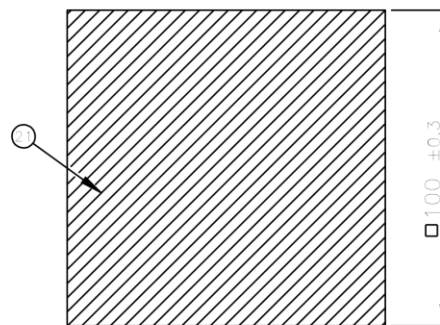

APPROVED BY: Chozen	 <small>TW Design Centre</small> This drawing and its inherent design concepts are property of Taoglas. Not to be copied or given to third parties without the written consent of Taoglas.
CHECK BY: Aaron	
DRAWN BY: Aron Yan	TITLE : 9in1 Guardian - 1*GNSS and 8*5G/4G MIMO 1m TGC-1.5DS with SMA(M)
DATE: 2021/8/17	PART NO.: MA990.A.001
UNLESS OTHERWISE SPECIFIED TOLERANCES ON: XX±0.3 X±0.1 X±0.2 XX±0.1 XXX±0.2	INIT: (mm) SCALE: 1:2.5 PAGES: 1/1 REV: D01
THIRD ANGLE PROJECTION	

## 7. Packaging

1 No. MA990.A.001 per small box  
 Box Dimensions - 260\*235\*105mm  
 Weight - 1.16Kg

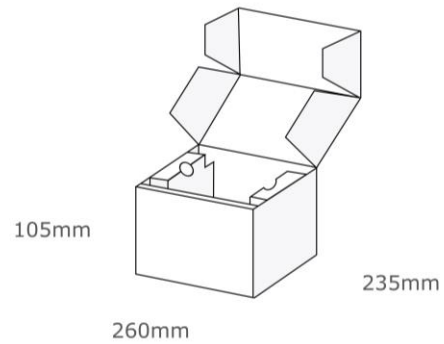

1 Outer Carton  
 Carton Dimensions - 540\*490\*240mm  
 8 pcs MA990.A.001 per carton  
 Weight - 9.9Kg

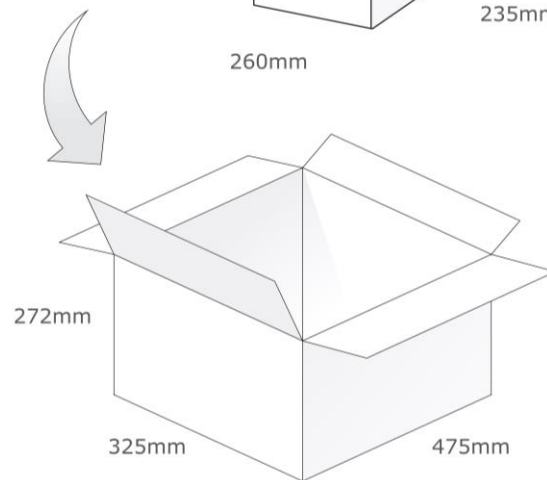

## 8. Application Note

The MA990.A.001 performance is affected by different cable lengths, in this section the performance is shown with different cable lengths.

### 8.1 Efficiency – 5G/4G MIMO

#### 5G/4G MIMO 1 & 8

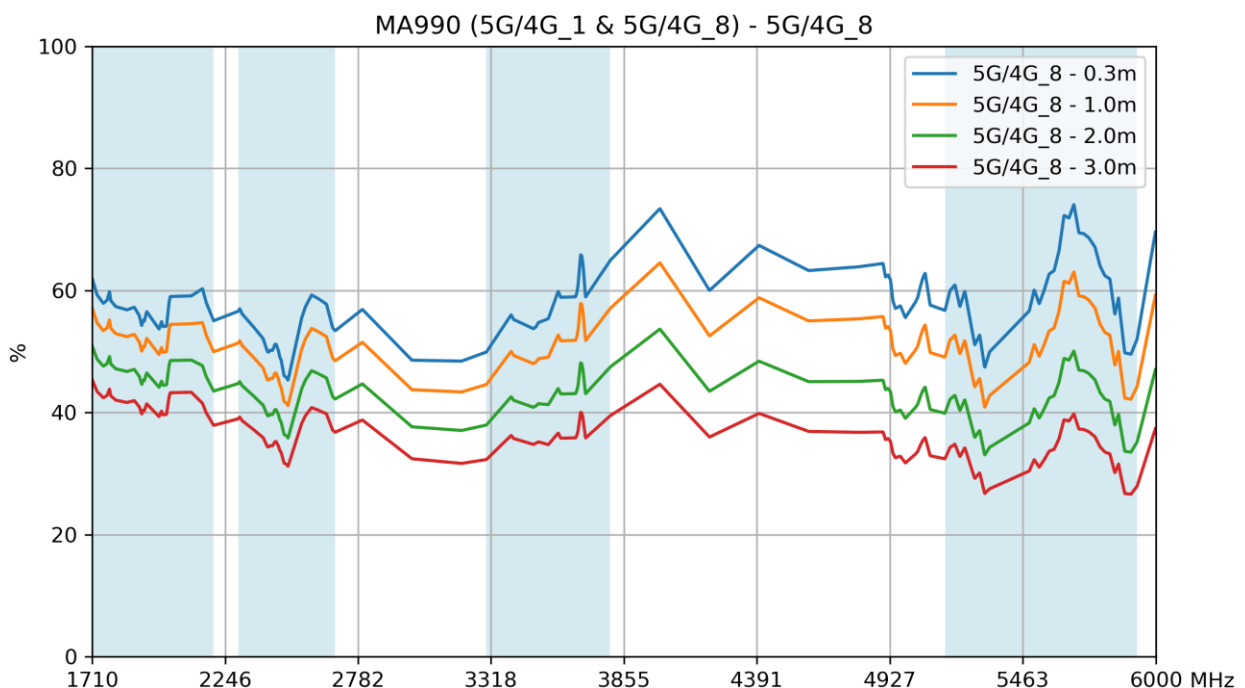
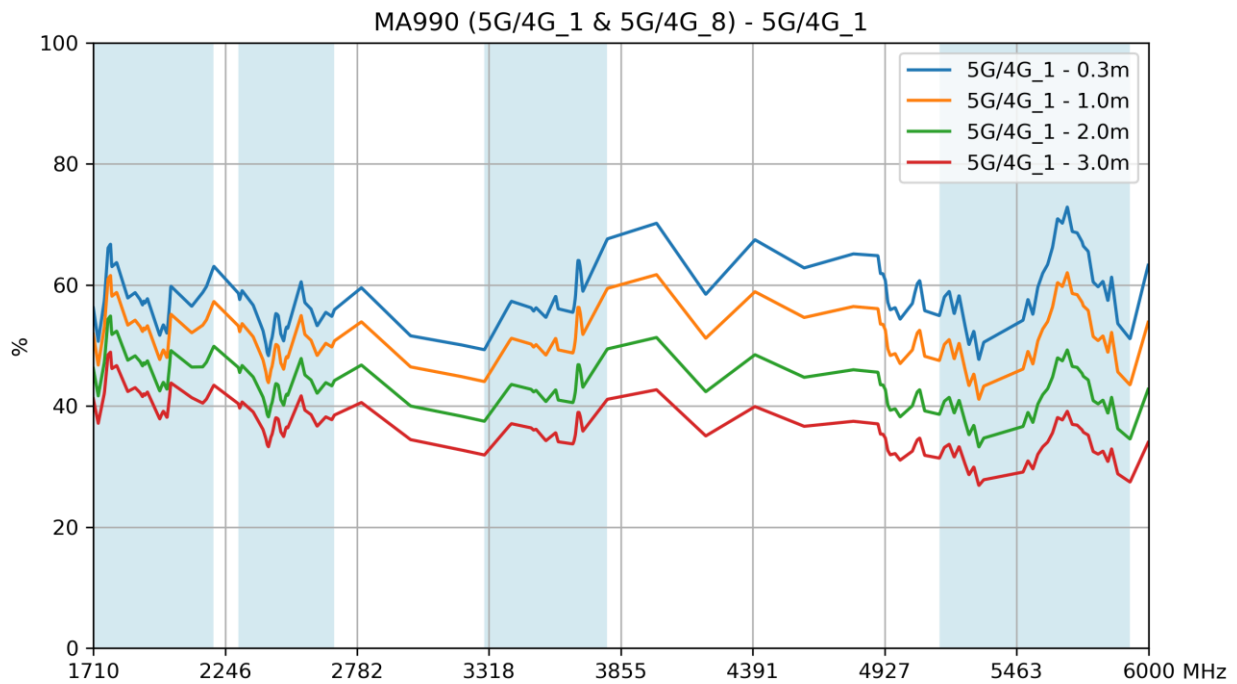



## 5G/4G MIMO 2 & 7

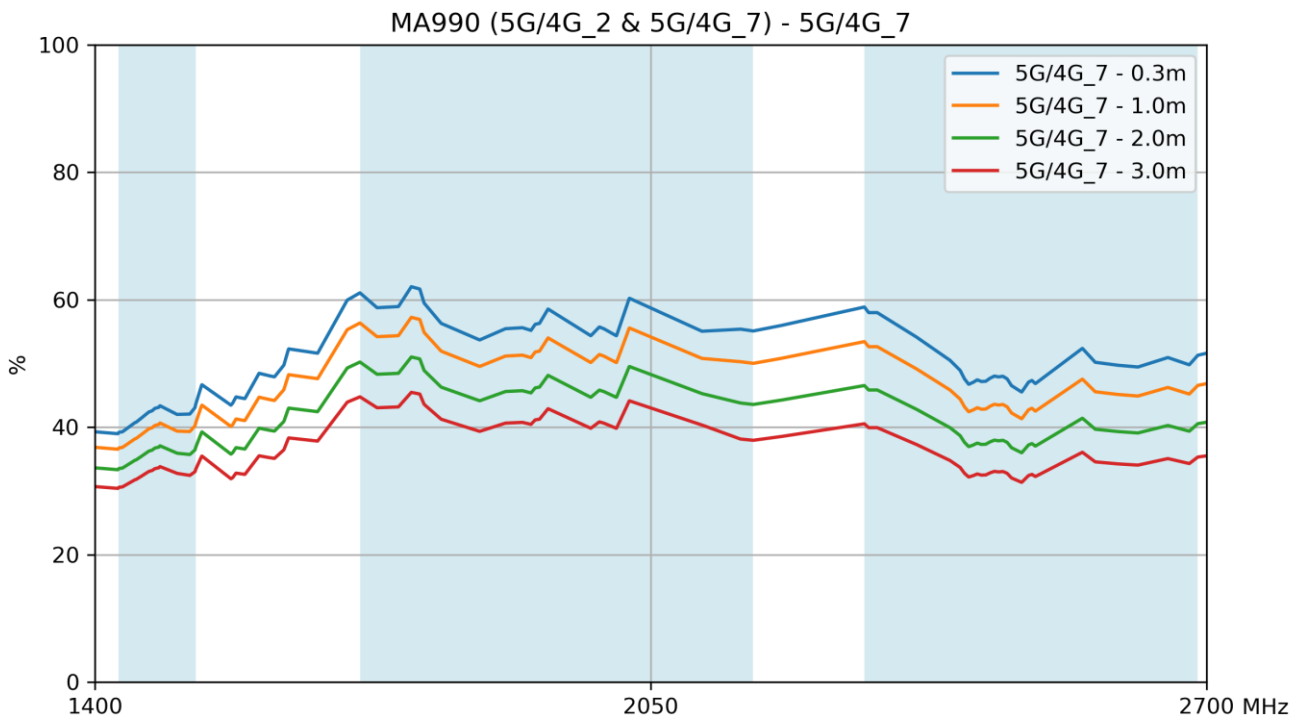
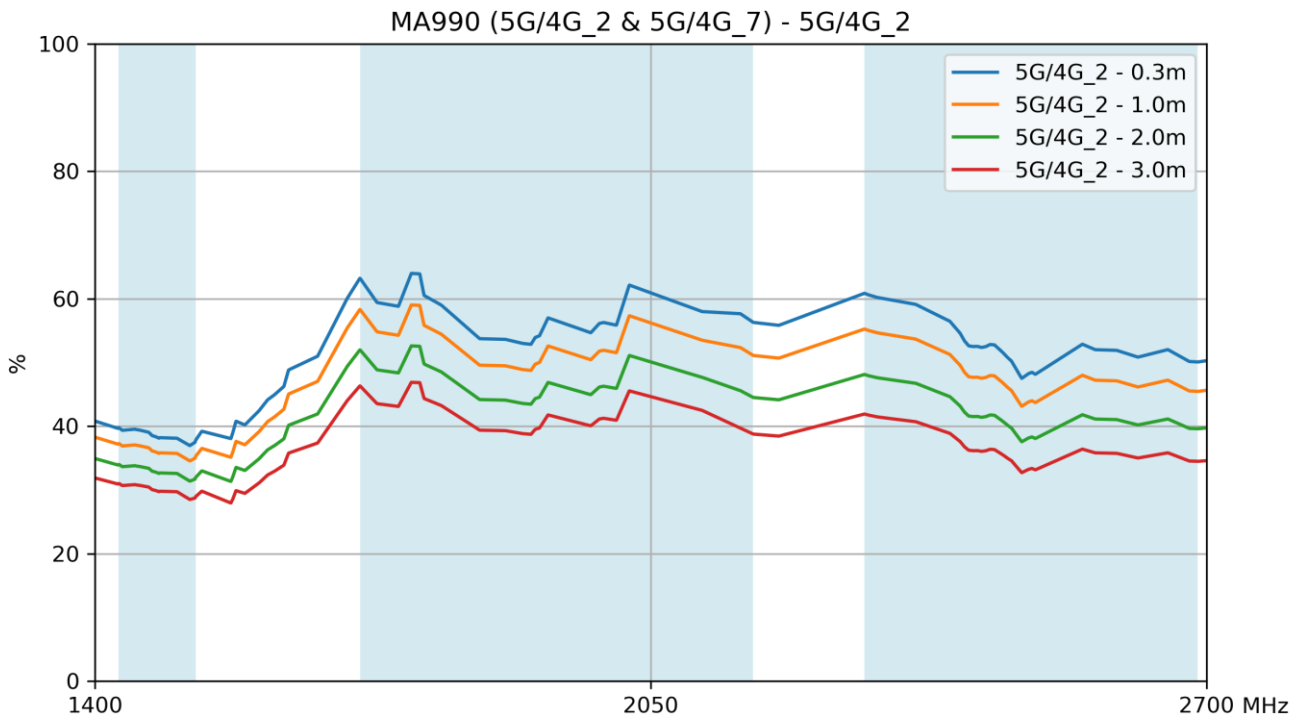

## 5G/4G MIMO 3 & 6

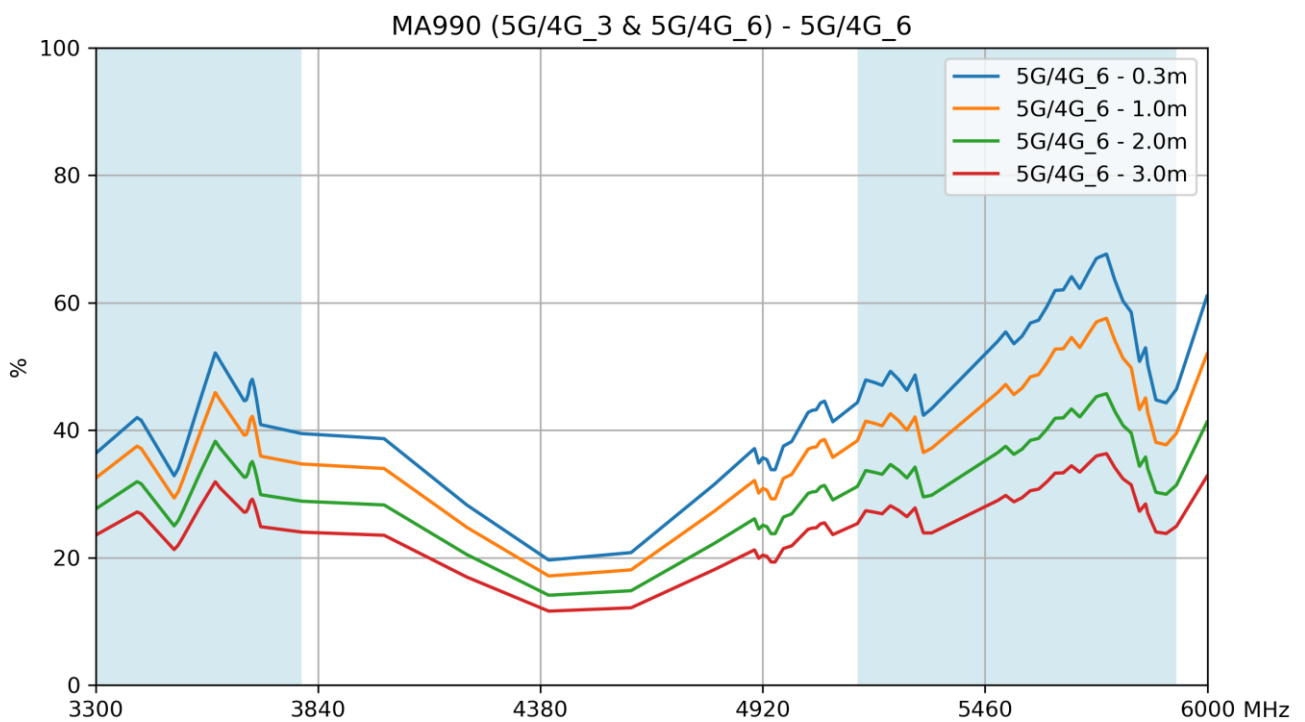
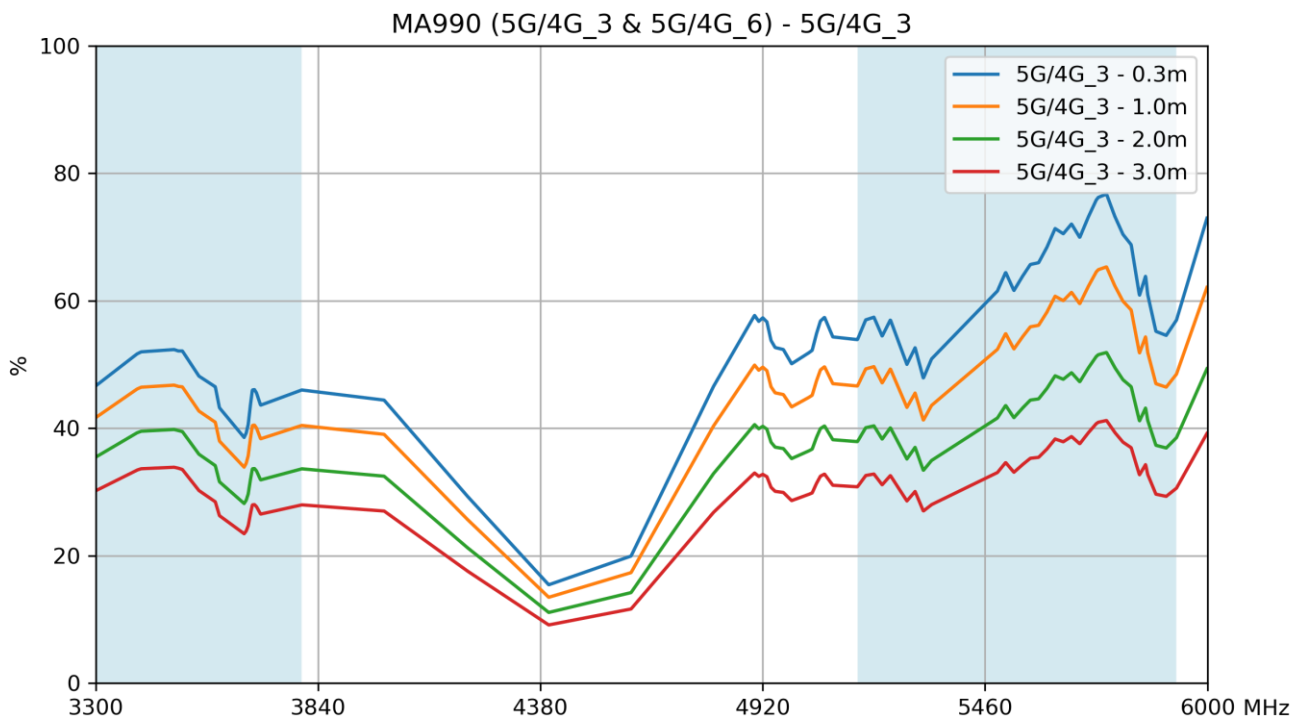

## 5G/4G MIMO 4 & 5

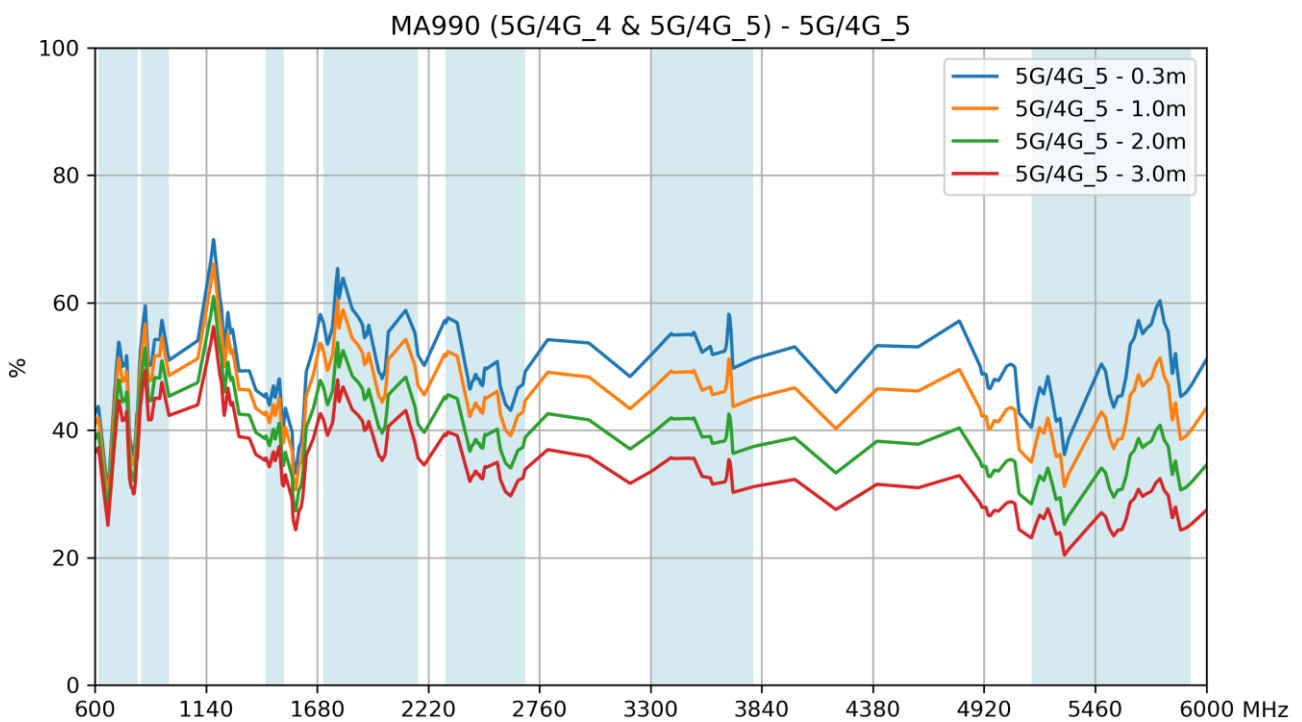
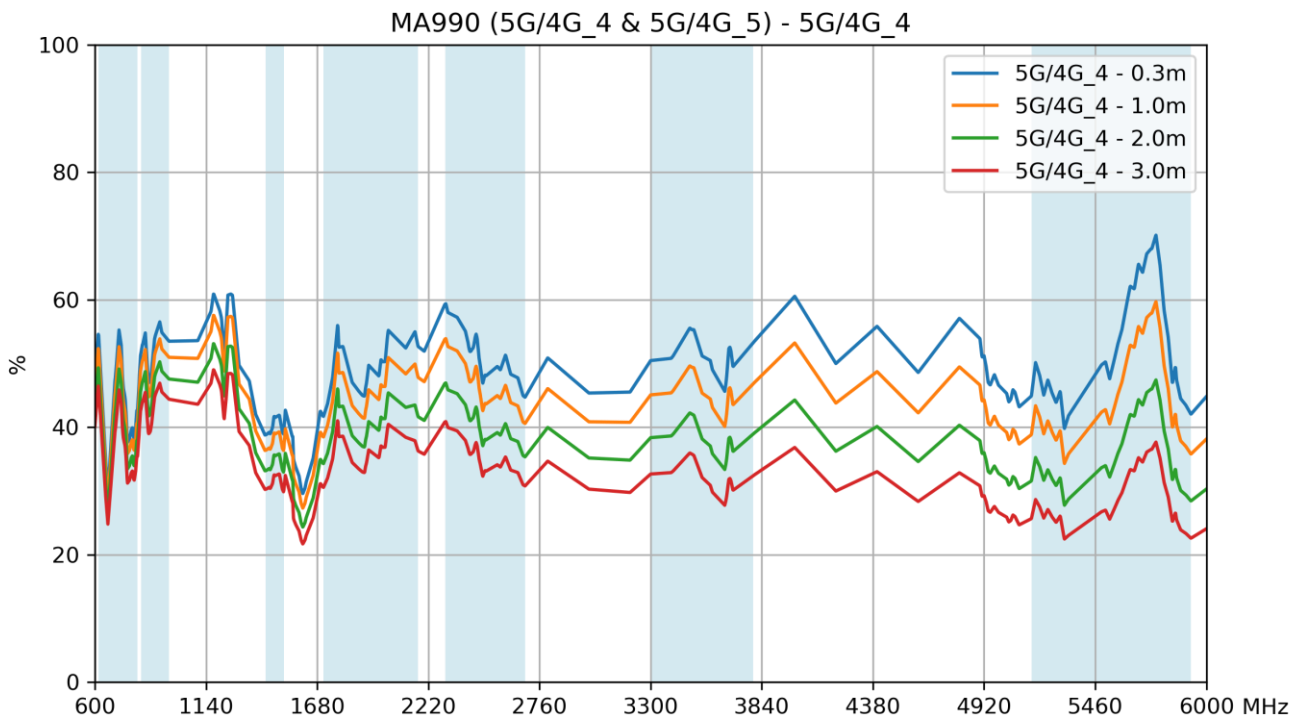

## 8.2 Average Gain – 5G/4G MIMO

### 5G/4G MIMO 1 & 8

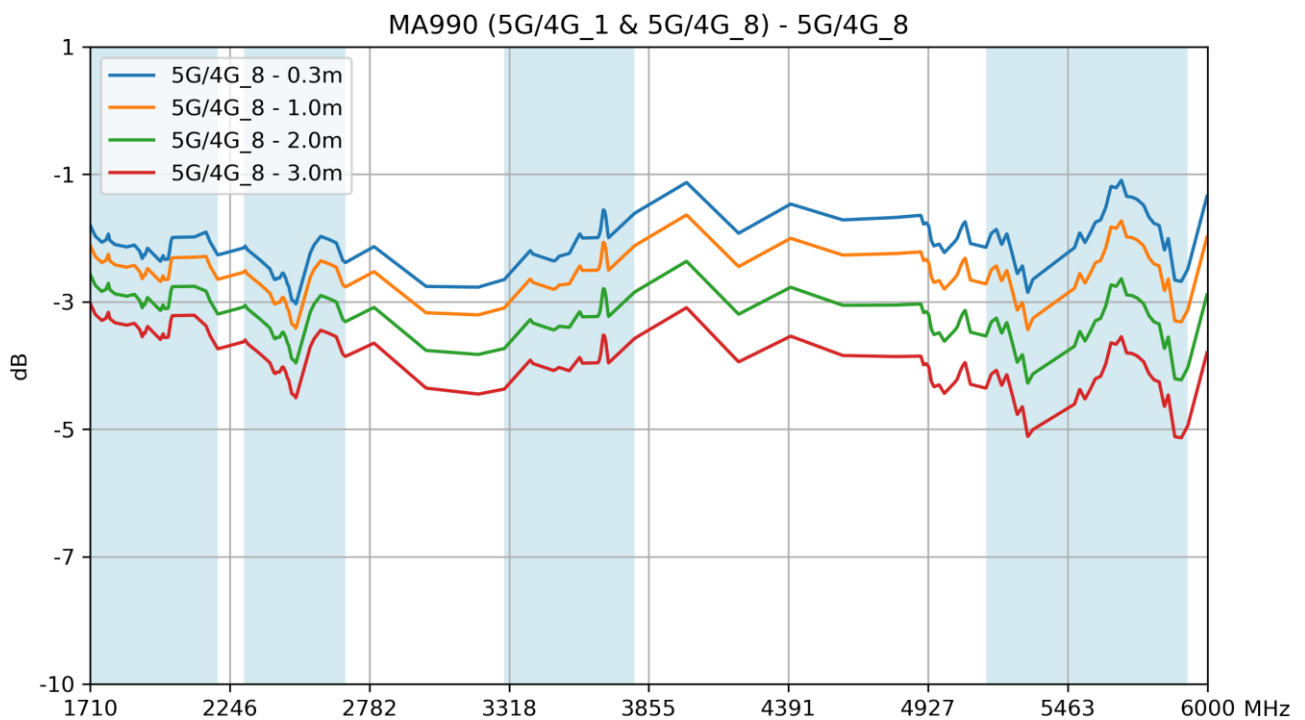
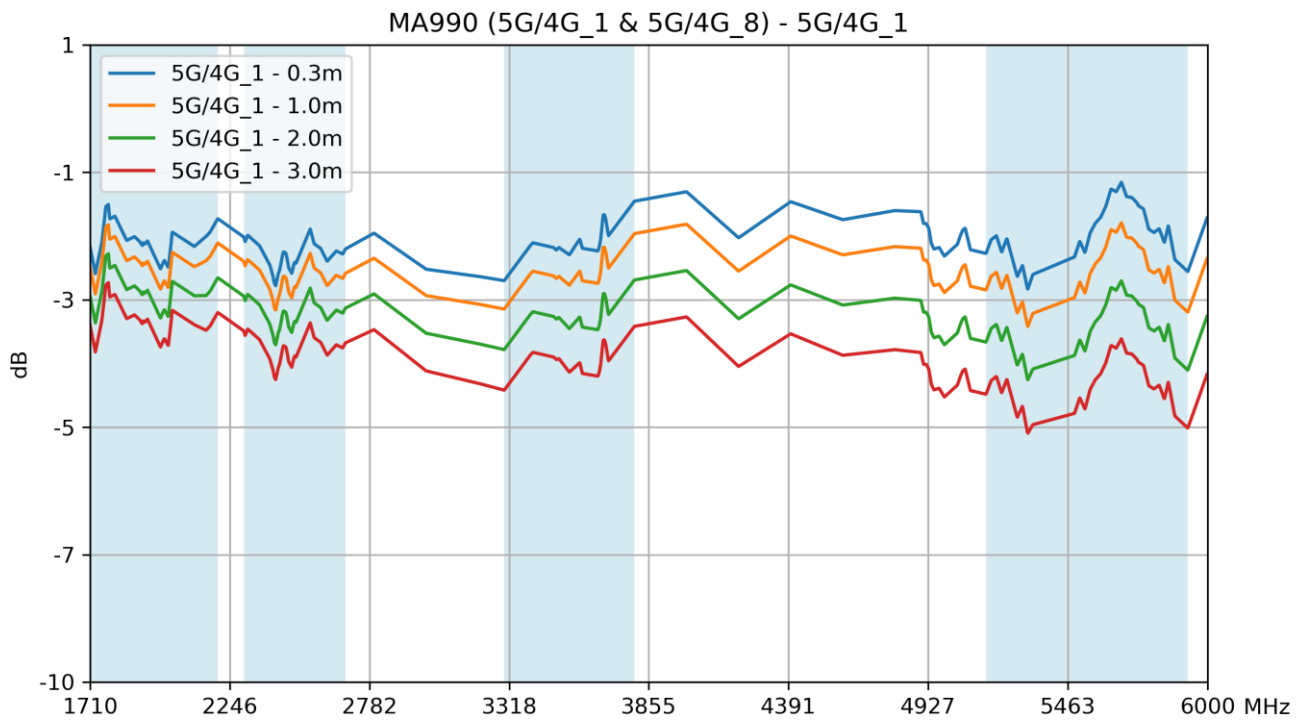

## 5G/4G MIMO 2 & 7

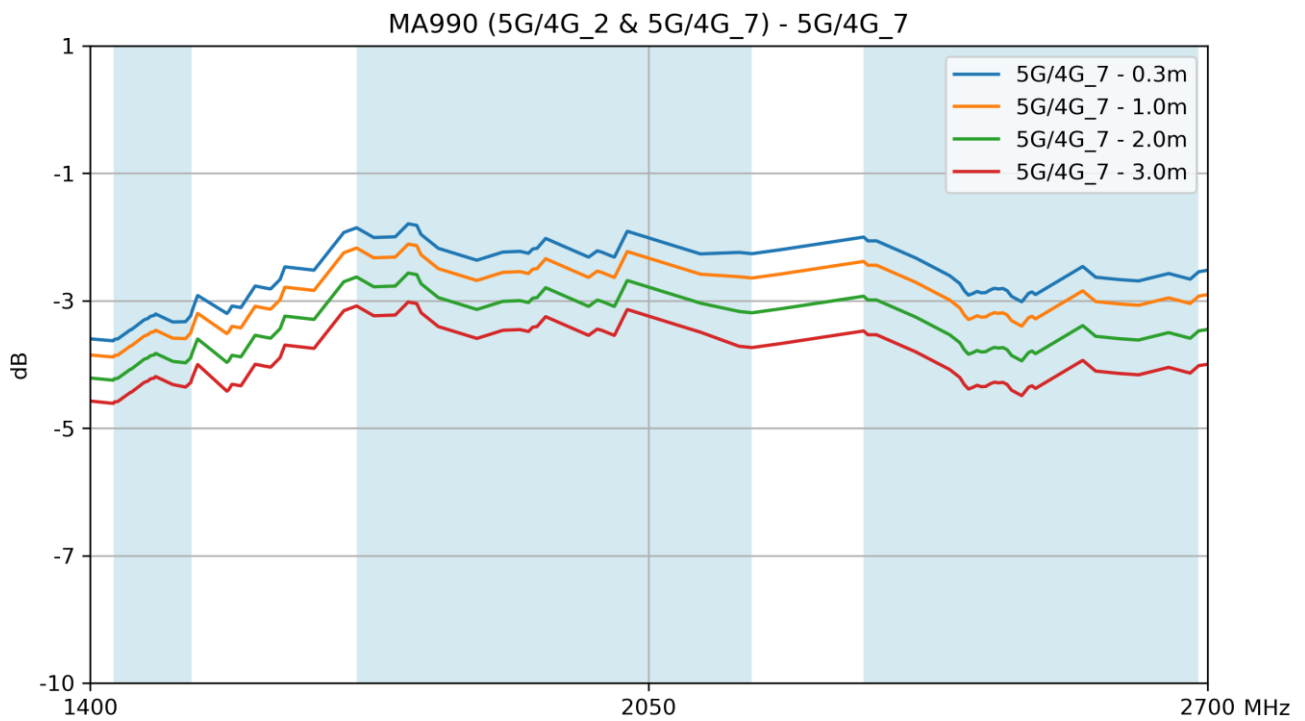
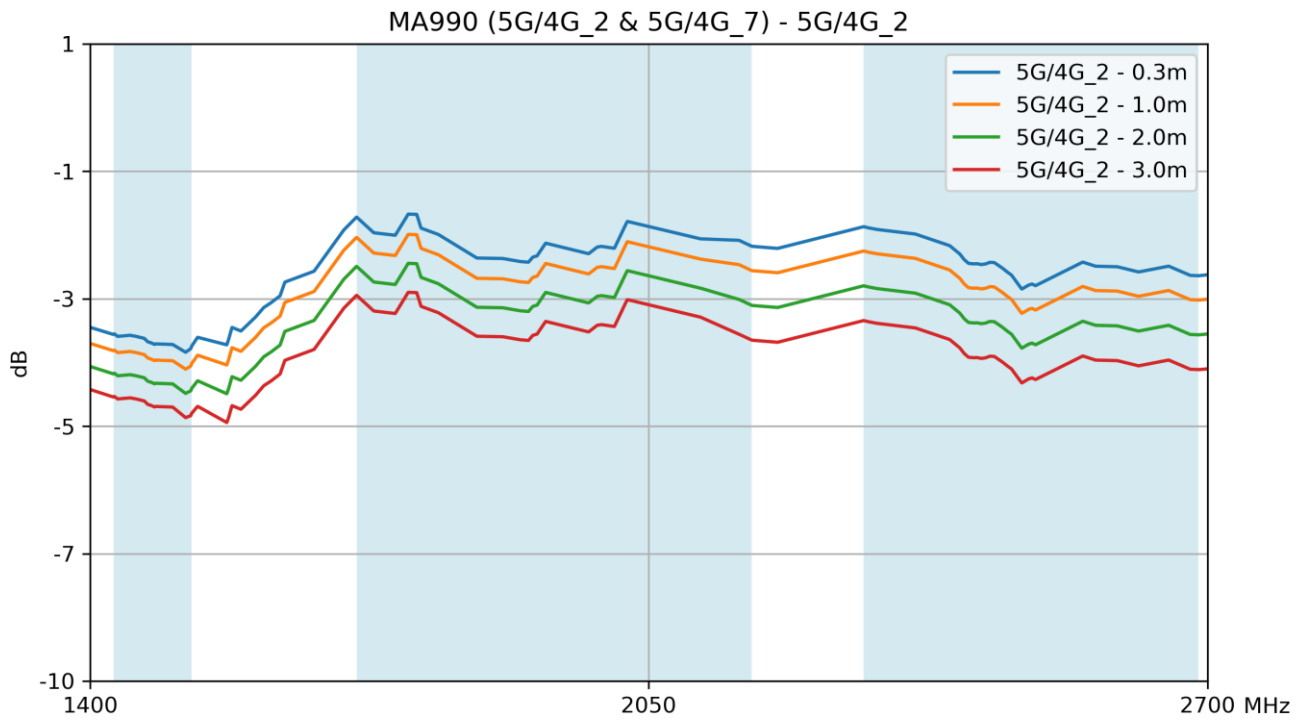

## 5G/4G MIMO 3 & 6

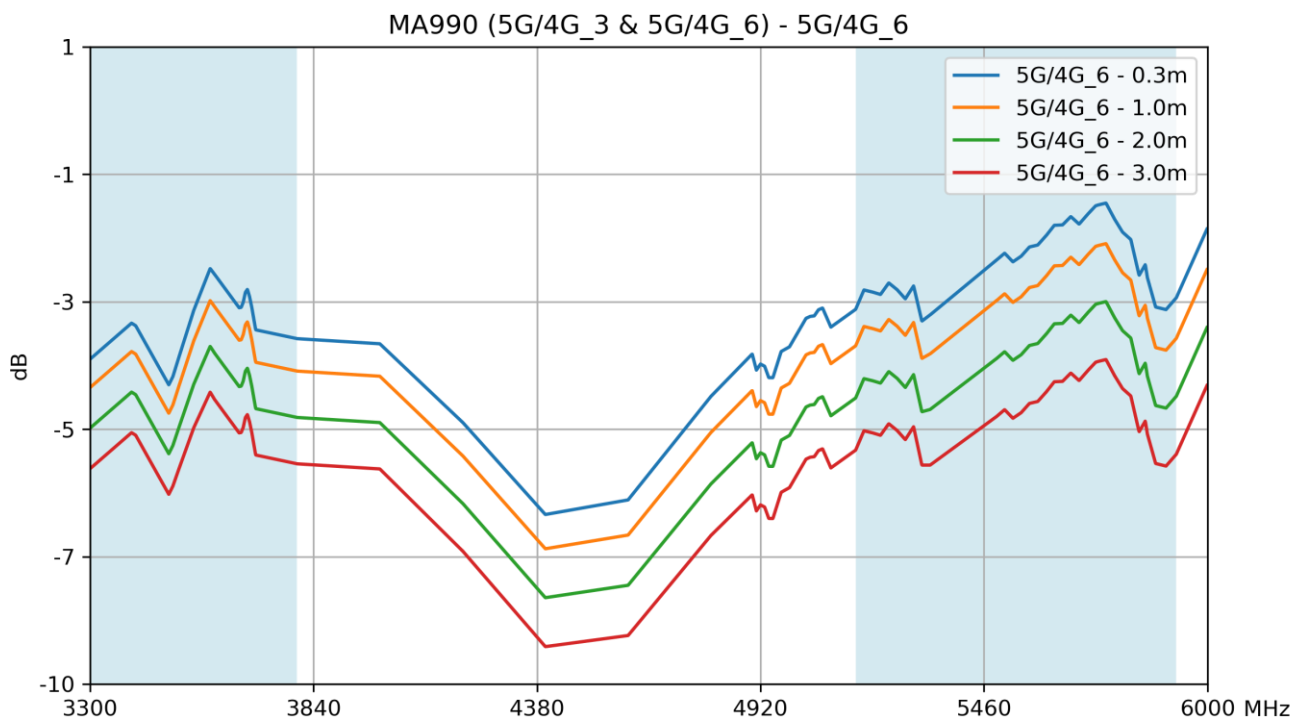
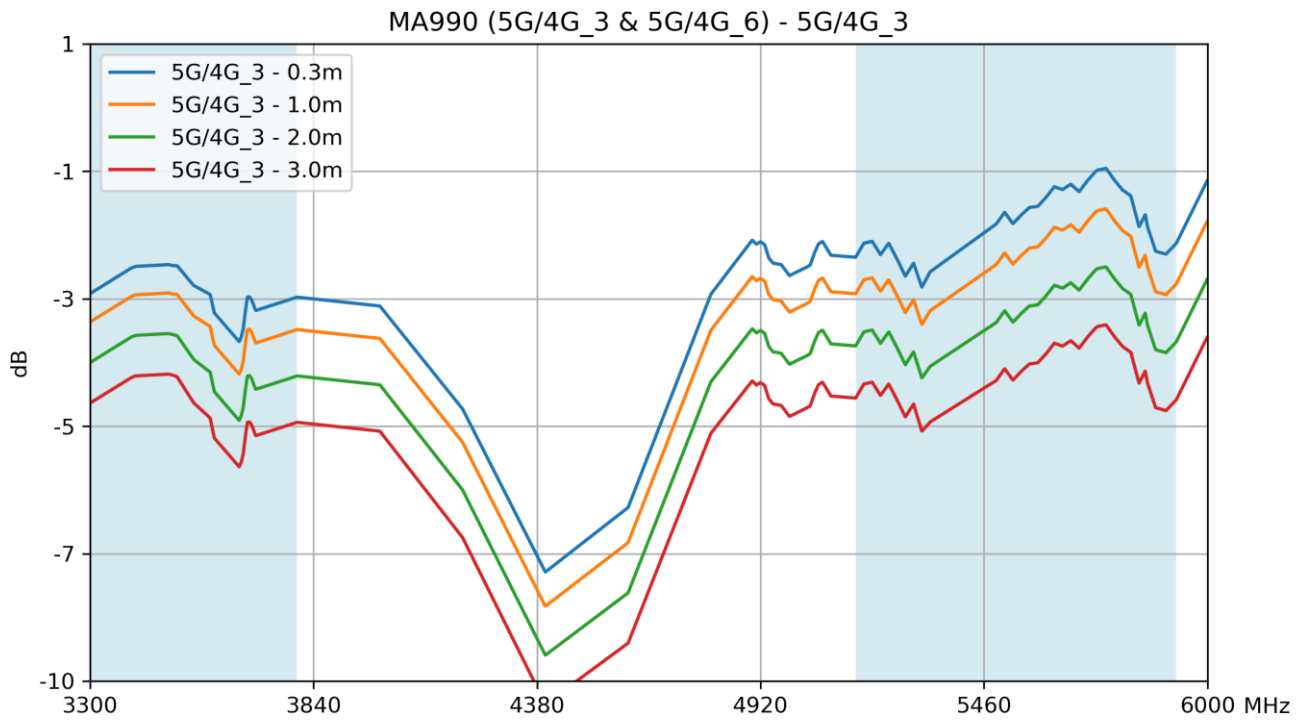

## 5G/4G MIMO 4 & 5

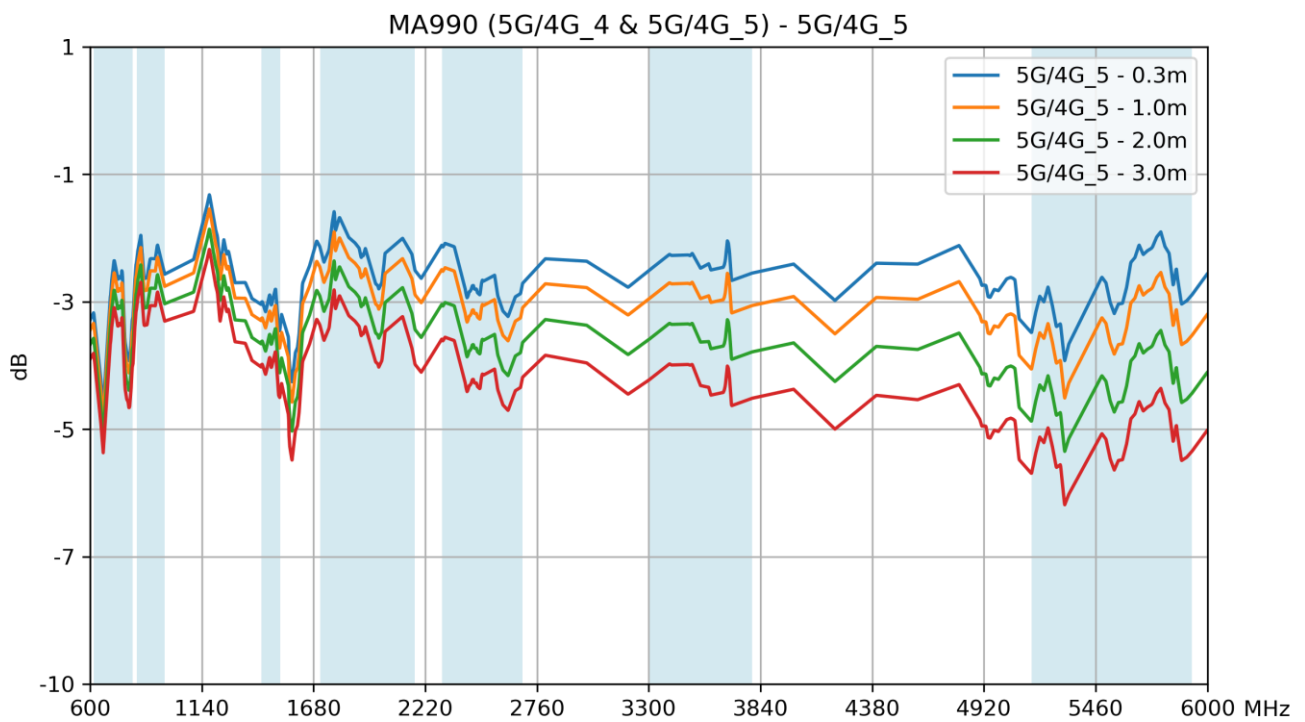
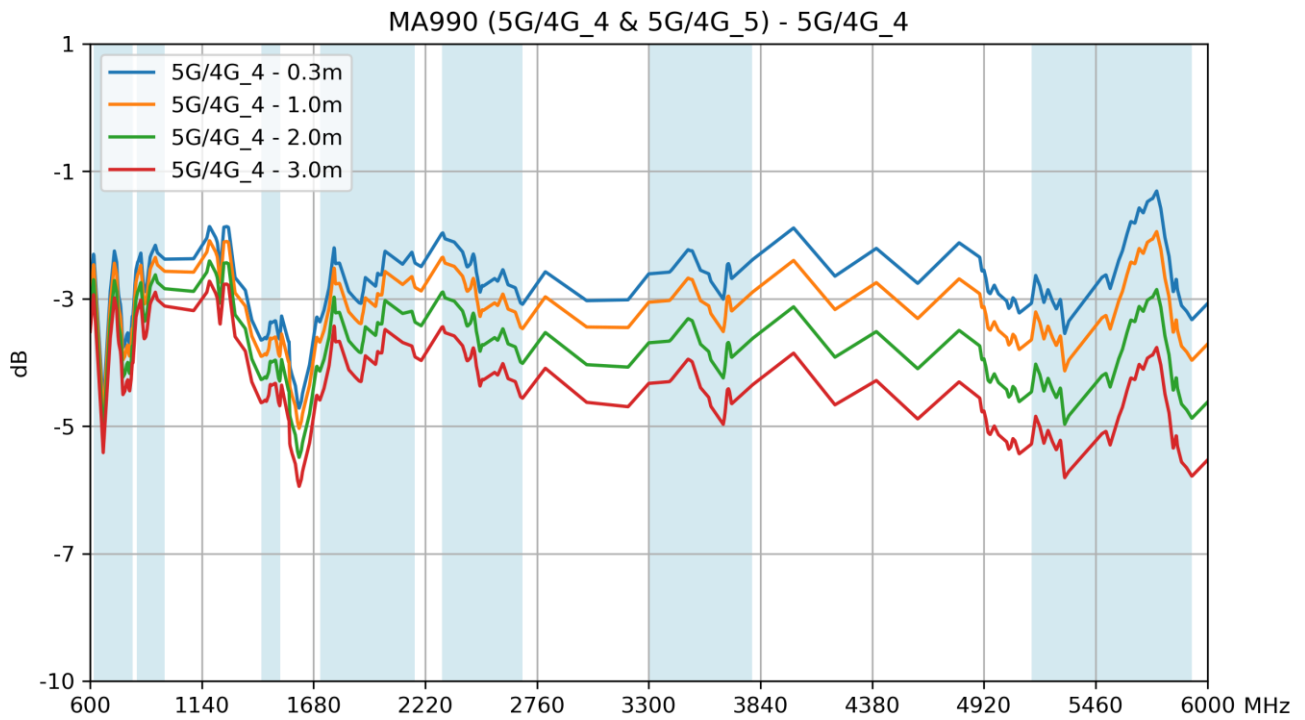

### 8.3 Peak Gain – 5G/4G MIMO

#### 5G/4G MIMO 1 & 8

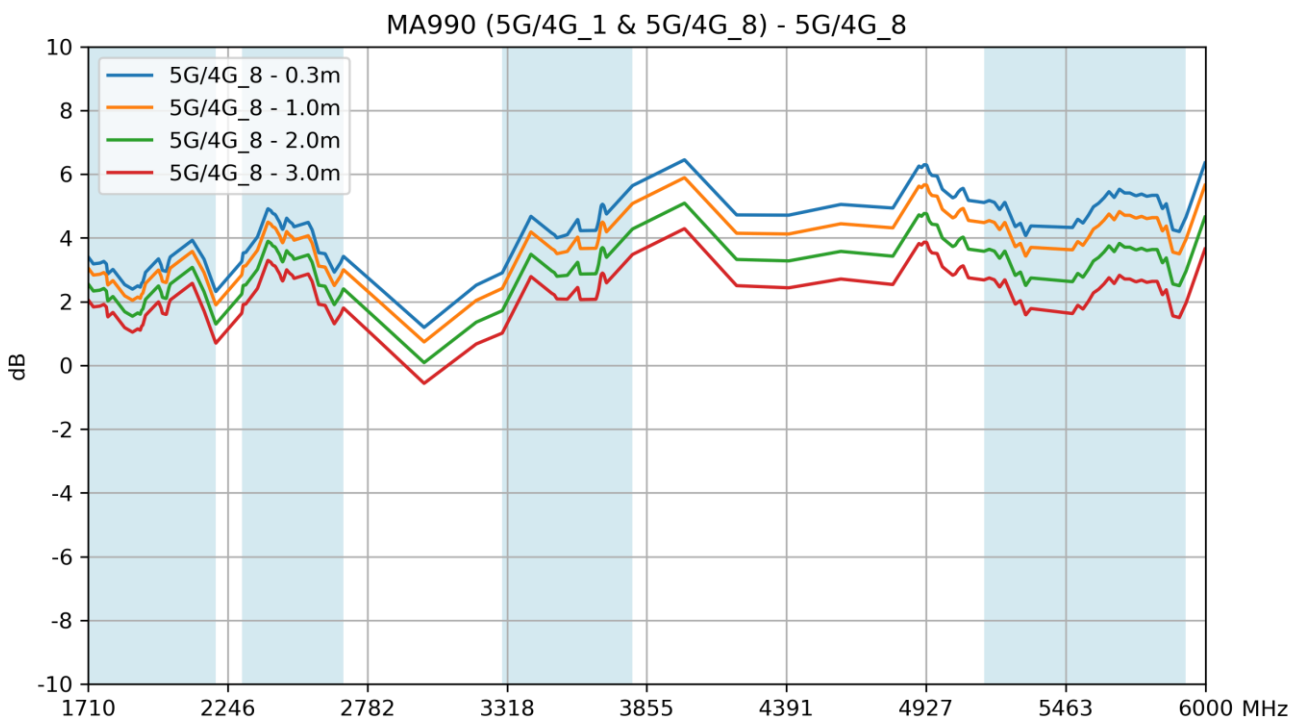
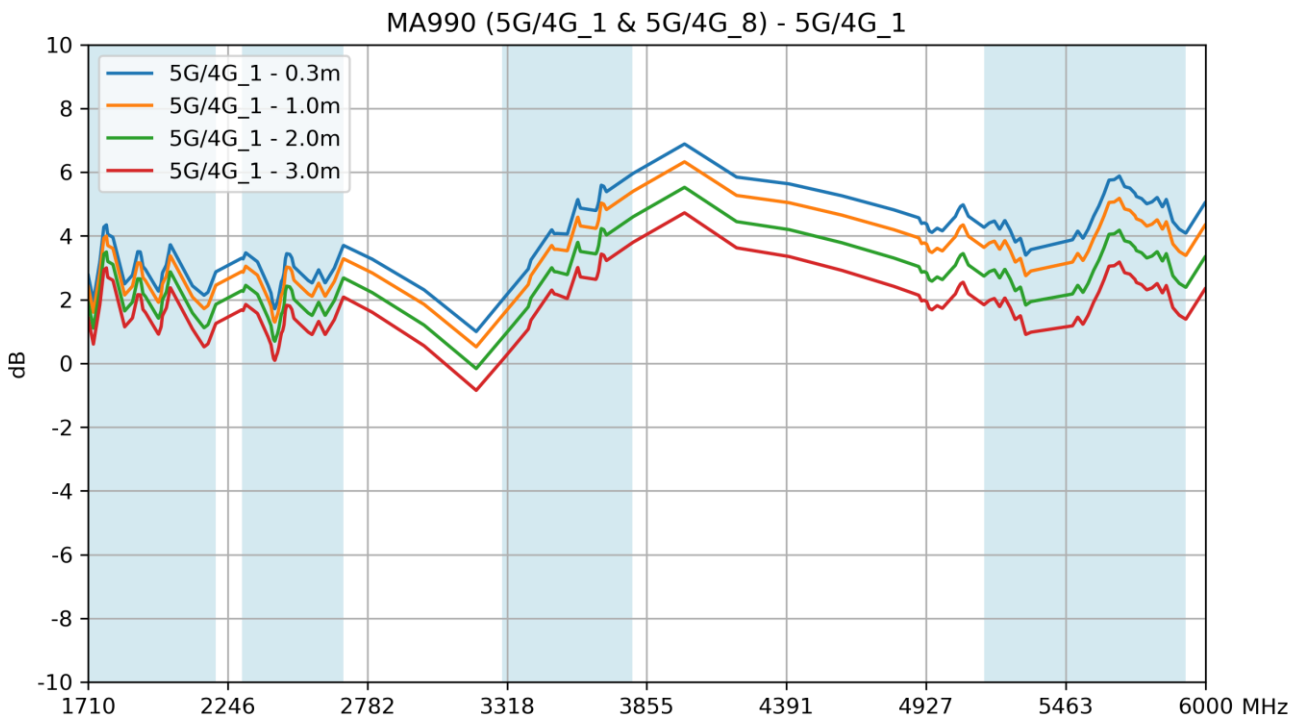



## 5G/4G MIMO 2 & 7

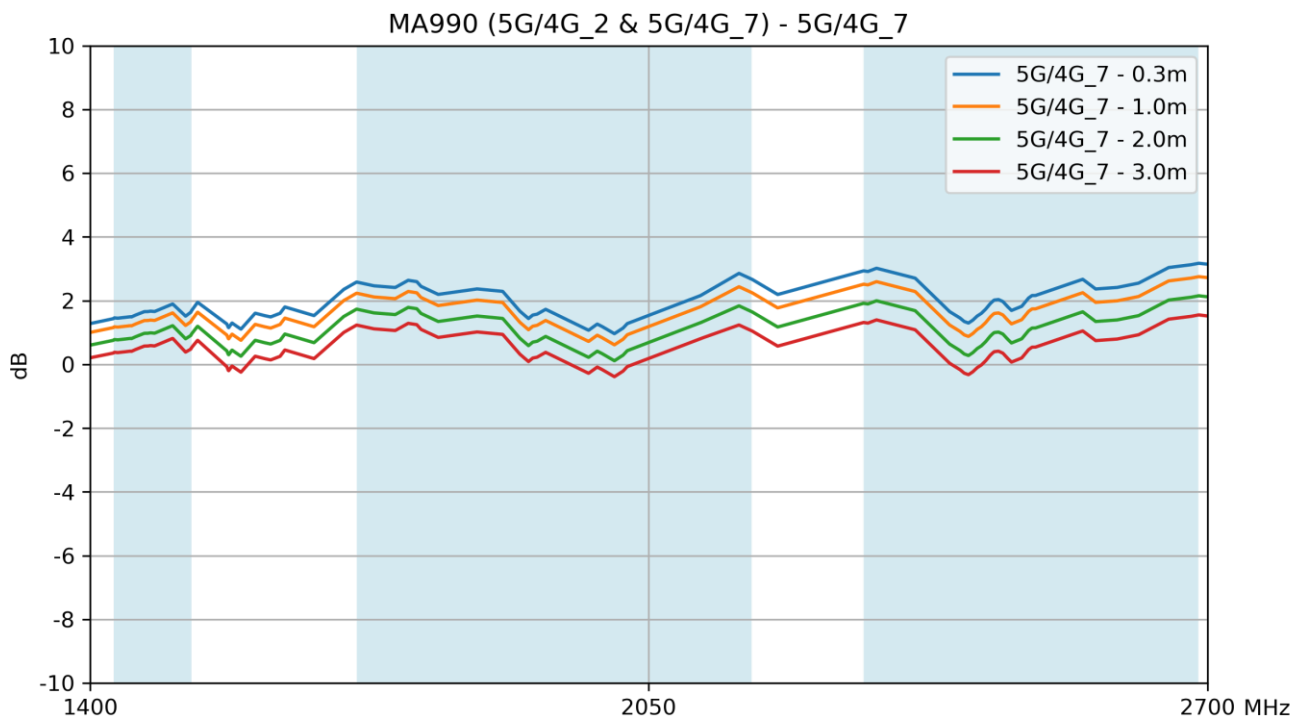
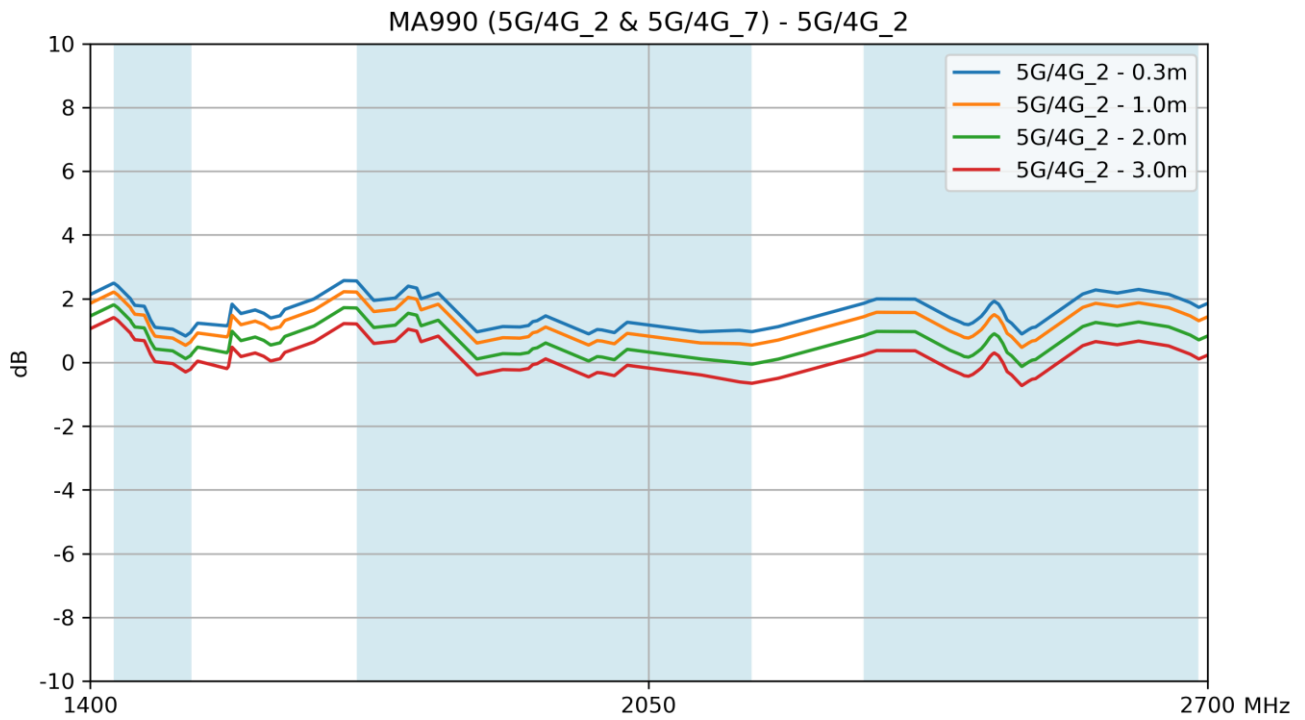

## 5G/4G MIMO 3 & 6

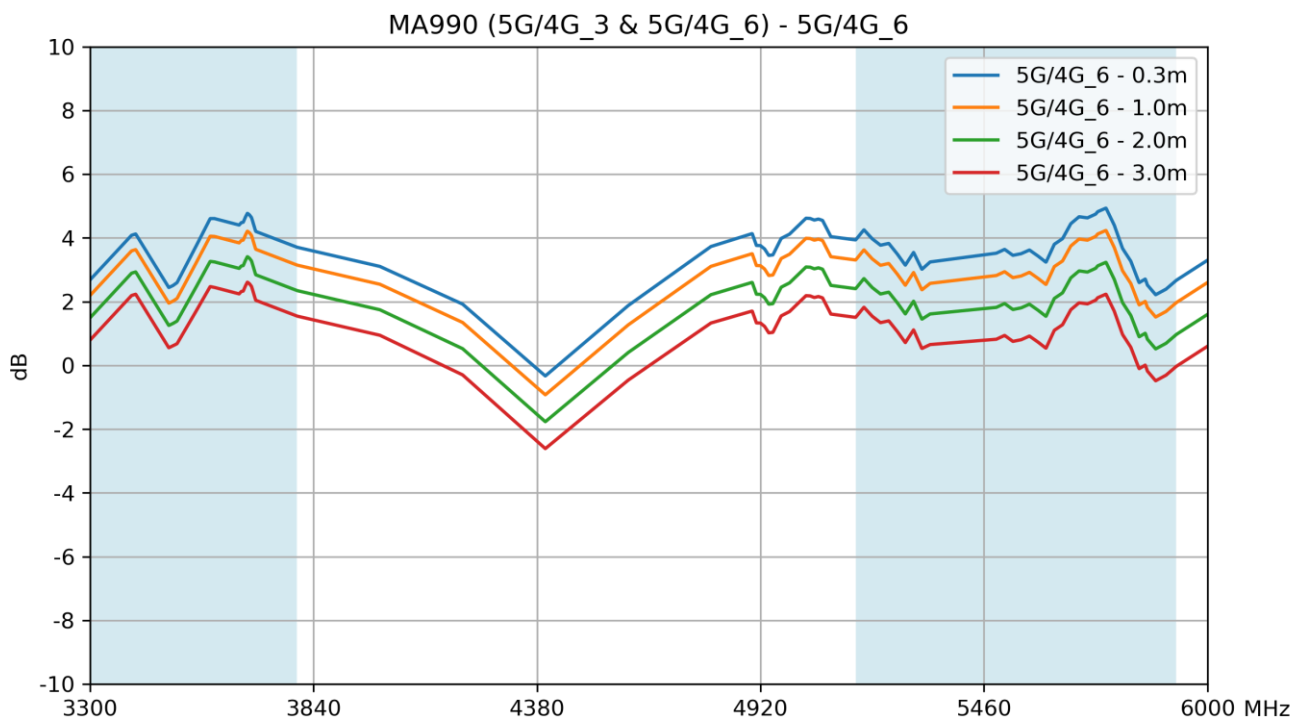
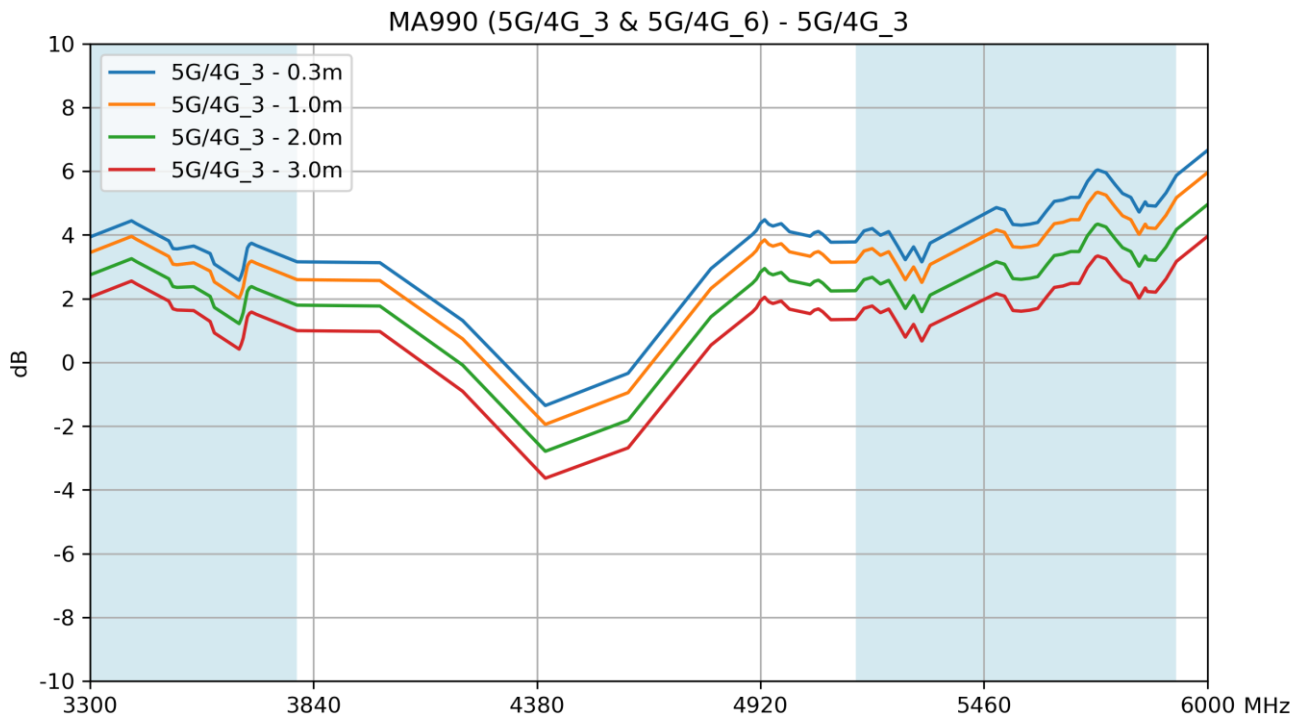

## 5G/4G MIMO 4 & 5

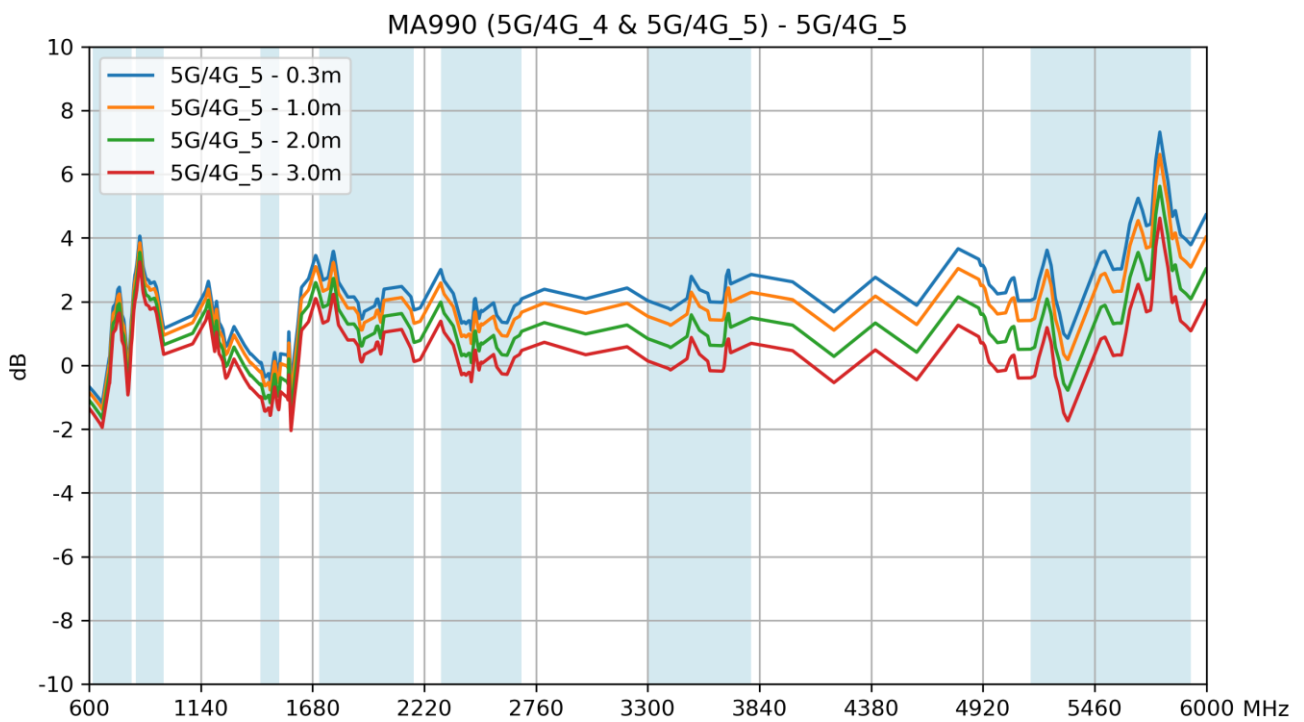
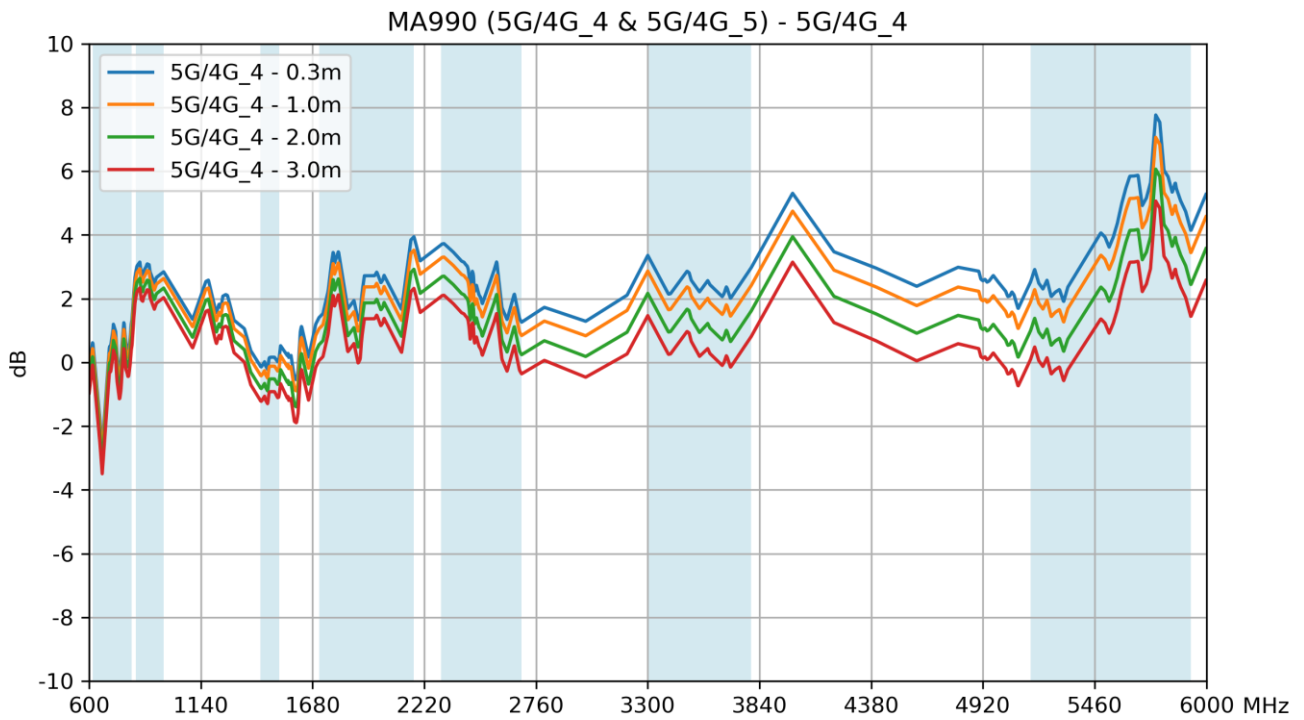

Changelog for the datasheet

SPE-22-8-017 – MA9914.A.002

Revision: A (Original First Release)	
Date:	2022-02-03
Notes:	
Author:	Jack Conroy

Previous Revisions



**TAOGLAS**®

[www.taoglas.com](http://www.taoglas.com)

