







Position switch, 1N/O+1N/C, roller lever, short

Part no. LS-11/LS
Catalog No. 290173
Eaton Catalog No. LS-11-LS
EL-Nummer (Norway) 0004315231

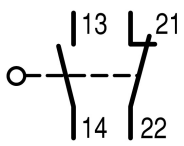
Delivery program

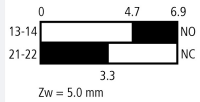
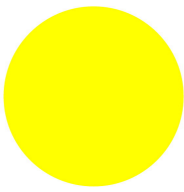
Basic function			Position switches Safety position switches
Part group reference			LS(M)-...
Product range			Roller lever
Degree of Protection			IP66, IP67
Features			Complete unit
Ambient temperature		°C	-25 - +70
Description			Short
Contacts			
N/O = Normally open			1 N/O
N/C = Normally closed			1 NC 
Notes			 = safety function, by positive opening to IEC/EN 60947-5-1
Contact sequence			
Contact travel  = Contact closed  = Contact open			
Positive opening (ZW)			yes
Colour			
Enclosure covers			Yellow
Enclosure covers			
Housing			Insulated material
Connection type			Cage Clamp
Notes			Cage-Clamp is a registered trademark of Wago Kontakttechnik, 32432 Minden, Germany. Accessories for the Cage-Clamp terminals from Wago: power comb, gray, Wago Article No. 264-402
Notes The operating head can be rotated at 90° intervals to adapt to the specified approach direction.			

Technical data

General			
Standards			IEC/EN 60947
Climatic proofing			Damp heat, constant, to IEC 60068-2-78; damp heat, cyclical, to IEC 60068-2-30
Ambient temperature		°C	-25 - +70
Mounting position			As required
Degree of Protection			IP66, IP67

Terminal capacities		mm ²	
Solid		mm ²	1 x (0.5 - 2.5)
Flexible with ferrule		mm ²	1 x (0.5 - 1.5)

Contacts/switching capacity

Rated impulse withstand voltage	U _{imp}	V AC	4000
Rated insulation voltage	U _i	V	400
Overvoltage category/pollution degree			III/3
Rated operational current	I _e	A	
AC-15			
24 V	I _e	A	6
220 V 230 V 240 V	I _e	A	6
380 V 400 V 415 V	I _e	A	4
DC-13			
24 V	I _e	A	3
110 V	I _e	A	0.6
220 V	I _e	A	0.3
Control circuit reliability			
at 24 V DC/5 mA	H _F	Fault probability	< 10 ⁻⁷ , < 1 fault in 10 ⁷ operations
at 5 V DC/1 mA	H _F	Fault probability	< 10 ⁻⁶ , < 1 failure at 5 x 10 ⁶ operations
Supply frequency		Hz	max. 400
Short-circuit rating to IEC/EN 60947-5-1			
max. fuse		A gG/gL	6
Repetition accuracy		mm	0.15
Rated conditional short-circuit current		kA	1

Mechanical variables

Lifespan, mechanical	Operations	x 10 ⁶	8
Mechanical shock resistance (half-sinusoidal shock, 20 ms)			
Standard-action contact		g	25
Operating frequency	Operations/h		≤ 6000

Actuation

Mechanical			
Actuating force at beginning/end of stroke		N	1.0/8.0
Actuating torque of rotary drives		Nm	0.2
Max. operating speed with DIN cam		m/s	1
Notes			for angle of actuation α = 30°/45°

Design verification as per IEC/EN 61439

Technical data for design verification			
Rated operational current for specified heat dissipation	I _n	A	6
Heat dissipation per pole, current-dependent	P _{vid}	W	0.17
Equipment heat dissipation, current-dependent	P _{vid}	W	0
Static heat dissipation, non-current-dependent	P _{vs}	W	0
Heat dissipation capacity	P _{diss}	W	0
Operating ambient temperature min.		°C	-25
Operating ambient temperature max.		°C	70
IEC/EN 61439 design verification			
10.2 Strength of materials and parts			
10.2.2 Corrosion resistance			Meets the product standard's requirements.
10.2.3.1 Verification of thermal stability of enclosures			Meets the product standard's requirements.
10.2.3.2 Verification of resistance of insulating materials to normal heat			Meets the product standard's requirements.
10.2.3.3 Verification of resistance of insulating materials to abnormal heat and fire due to internal electric effects			Meets the product standard's requirements.
10.2.4 Resistance to ultra-violet (UV) radiation			Meets the product standard's requirements.

10.2.5 Lifting		Does not apply, since the entire switchgear needs to be evaluated.
10.2.6 Mechanical impact		Does not apply, since the entire switchgear needs to be evaluated.
10.2.7 Inscriptions		Meets the product standard's requirements.
10.3 Degree of protection of ASSEMBLIES		Does not apply, since the entire switchgear needs to be evaluated.
10.4 Clearances and creepage distances		Meets the product standard's requirements.
10.5 Protection against electric shock		Does not apply, since the entire switchgear needs to be evaluated.
10.6 Incorporation of switching devices and components		Does not apply, since the entire switchgear needs to be evaluated.
10.7 Internal electrical circuits and connections		Is the panel builder's responsibility.
10.8 Connections for external conductors		Is the panel builder's responsibility.
10.9 Insulation properties		
10.9.2 Power-frequency electric strength		Is the panel builder's responsibility.
10.9.3 Impulse withstand voltage		Is the panel builder's responsibility.
10.9.4 Testing of enclosures made of insulating material		Is the panel builder's responsibility.
10.10 Temperature rise		The panel builder is responsible for the temperature rise calculation. Eaton will provide heat dissipation data for the devices.
10.11 Short-circuit rating		Is the panel builder's responsibility. The specifications for the switchgear must be observed.
10.12 Electromagnetic compatibility		Is the panel builder's responsibility. The specifications for the switchgear must be observed.
10.13 Mechanical function		The device meets the requirements, provided the information in the instruction leaflet (IL) is observed.

Technical data ETIM 7.0

Sensors (EG000026) / End switch (EC000030)		
Electric engineering, automation, process control engineering / Binary sensor technology, safety-related sensor technology / Position switch / Position switch (Type 1) (ecl@ss10.0.1-27-27-06-01 [AGZ382015])		
Width sensor	mm	31
Diameter sensor	mm	0
Height of sensor	mm	61
Length of sensor	mm	33.5
Rated operation current I _e at AC-15, 24 V	A	6
Rated operation current I _e at AC-15, 125 V	A	6
Rated operation current I _e at AC-15, 230 V	A	6
Rated operation current I _e at DC-13, 24 V	A	3
Rated operation current I _e at DC-13, 125 V	A	0.8
Rated operation current I _e at DC-13, 230 V	A	0.3
Switching function		Slow-action switch
Switching function latching		No
Output electronic		No
Forced opening		Yes
Number of safety auxiliary contacts		1
Number of contacts as normally closed contact		1
Number of contacts as normally open contact		1
Number of contacts as change-over contact		0
Type of interface		None
Type of interface for safety communication		None
Construction type housing		Cuboid
Material housing		Plastic
Coating housing		Other
Type of control element		Roller lever
Alignment of the control element		Other
Type of electric connection		Other
With status indication		No
Suitable for safety functions		Yes
Explosion safety category for gas		None
Explosion safety category for dust		None
Ambient temperature during operating	°C	25 - 70

Degree of protection (IP)		IP67
Degree of protection (NEMA)		4X

Approvals

Product Standards		IEC/EN 60947-5; UL 508; CSA-C22.2 No. 14; CE marking
UL File No.		E29184
UL Category Control No.		NKCR
CSA File No.		12528
CSA Class No.		3211-03
North America Certification		UL listed, CSA certified
Degree of Protection		IEC: IP66, 67, UL/CSA Type 3R, 4X (indoor use only), 12, 13

Dimensions

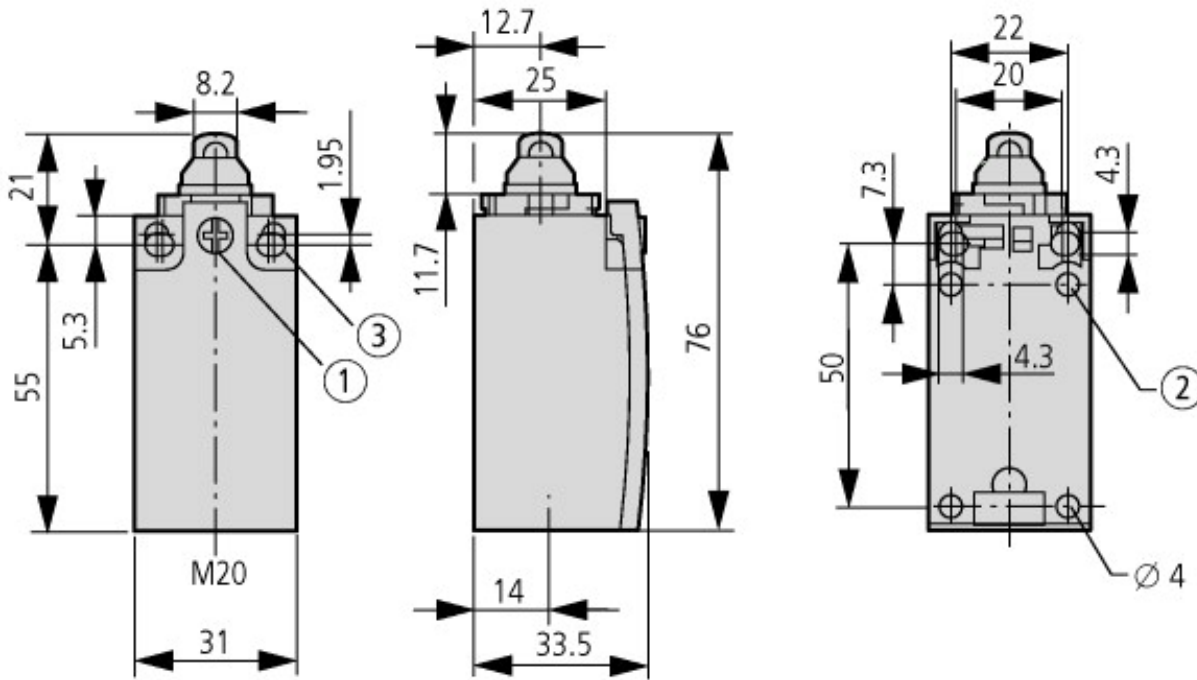

- ① Tightening torque of cover screws: 0.8 Nm ± 0.2 Nm
- ② only with LS (insulated version)
- ③ Fixing screws 2 x M4 ≥ 30
- $M_A = 1.5$ Nm

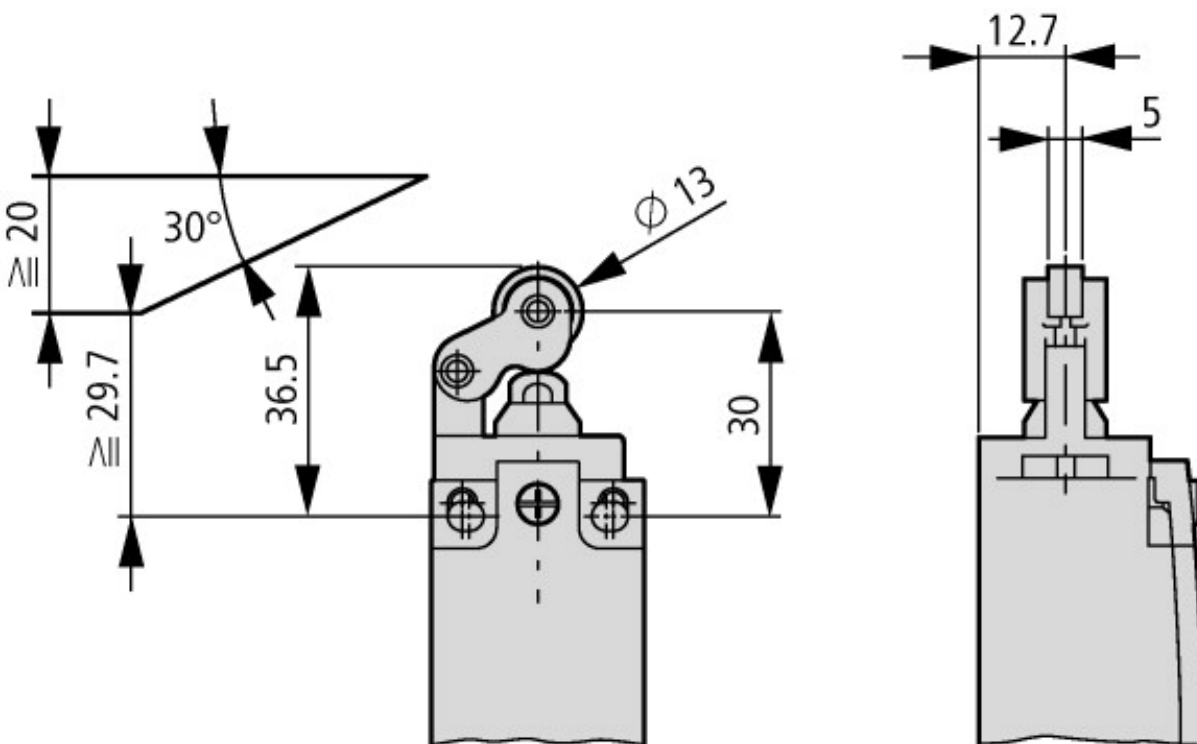

Additional product information (links)

IL053001ZU LS-Titan position switch: basic device

IL053001ZU LS-Titan position switch: basic device

ftp://ftp.moeller.net/DOCUMENTATION/AWA_INSTRUCTIONS/IL053001ZU2018_06.pdf