

## LOGO!

### Manual

This manual has the order number:  
6ED1050-1AA00-0BE8

04/2011

A5E03556174-01

### Preface

---

Getting started with LOGO!	1
LOGO! installation and wiring	2
Programming LOGO!	3
LOGO! functions	4
UDF (User-Defined Function) (0BA7 only)	5
Data Log (0BA7 only)	6
Configuring LOGO!	7
Applicable cards	8
LOGO! software	9
Applications	10
Technical data	A
Determining the cycle time	B
LOGO! without display ("LOGO! Pure")	C
LOGO! menu structure	D
Order numbers	E
Abbreviations	F

## Legal information

### Warning notice system

This manual contains notices you have to observe in order to ensure your personal safety, as well as to prevent damage to property. The notices referring to your personal safety are highlighted in the manual by a safety alert symbol, notices referring only to property damage have no safety alert symbol. These notices shown below are graded according to the degree of danger.

<b>⚠ DANGER</b>
indicates that death or severe personal injury <b>will</b> result if proper precautions are not taken.
<b>⚠ WARNING</b>
indicates that death or severe personal injury <b>may</b> result if proper precautions are not taken.
<b>⚠ CAUTION</b>
with a safety alert symbol, indicates that minor personal injury can result if proper precautions are not taken.
<b>CAUTION</b>
without a safety alert symbol, indicates that property damage can result if proper precautions are not taken.
<b>NOTICE</b>
indicates that an unintended result or situation can occur if the corresponding information is not taken into account.

If more than one degree of danger is present, the warning notice representing the highest degree of danger will be used. A notice warning of injury to persons with a safety alert symbol may also include a warning relating to property damage.

### Qualified Personnel

The product/system described in this documentation may be operated only by **personnel qualified** for the specific task in accordance with the relevant documentation for the specific task, in particular its warning notices and safety instructions. Qualified personnel are those who, based on their training and experience, are capable of identifying risks and avoiding potential hazards when working with these products/systems.

### Proper use of Siemens products

Note the following:

<b>⚠ WARNING</b>
Siemens products may only be used for the applications described in the catalog and in the relevant technical documentation. If products and components from other manufacturers are used, these must be recommended or approved by Siemens. Proper transport, storage, installation, assembly, commissioning, operation and maintenance are required to ensure that the products operate safely and without any problems. The permissible ambient conditions must be adhered to. The information in the relevant documentation must be observed.

### Trademarks

All names identified by ® are registered trademarks of the Siemens AG. The remaining trademarks in this publication may be trademarks whose use by third parties for their own purposes could violate the rights of the owner.

### Disclaimer of Liability

We have reviewed the contents of this publication to ensure consistency with the hardware and software described. Since variance cannot be precluded entirely, we cannot guarantee full consistency. However, the information in this publication is reviewed regularly and any necessary corrections are included in subsequent editions.

(A )

가

# Preface

We thank you for purchasing LOGO! and congratulate you on your decision. With LOGO! you have acquired a logic module that meets the stringent quality requirements of ISO 9001.

LOGO! can be used in many fields of applications. Due to its high functionality and easy operation, LOGO! offers you the utmost efficiency for almost any application.

## Purpose of this manual

This LOGO! manual provides you with information about the creation of circuit programs, about the installation and use of LOGO! 0BA6 Base Modules, LOGO! 0BA7 Base Modules with more enhanced features, the LOGO! TD (Text Display), and LOGO! expansion modules, and about their compatibility with the previous 0BA0-0BA5 versions (0BAx are the last four characters of the order number of the Base Modules and differentiate the device series).

## LOGO!'s place in information technology

The wiring information in your LOGO! manual is also found in the LOGO! Product Info included with all devices. For further information on programming the LOGO! on your PC, refer to the Online Help for LOGO!Soft Comfort.

LOGO!Soft Comfort is LOGO! programming software for PCs. It runs under Windows® (including Windows XP® and Windows 7®), Linux®, and Mac OS X®. It helps you to get started with LOGO! and to write, test, print out and archive your programs, independent of the LOGO!.

## Guide

The manual is divided into the following chapters:

- Getting started with LOGO!
- LOGO! installation and wiring
- Programming LOGO!
- LOGO! functions
- UDF (User-Defined Function)
- Data Log
- Configuring LOGO!
- Applicable cards
- LOGO! software
- Applications

The manual also includes appendices A - F, which follow the chapters.

---

**Note**

Some chapters/sections in this manual specifically relate to the LOGO! 0BA7 devices. For easy identification, the names of these chapters/sections end with "(0BA7 only)".

---

**Valid range of this manual**

The manual applies to devices of series 0BA6 and 0BA7.

**New features of the LOGO! 0BA7 device series**

The following features are new for the LOGO! 0BA7 devices:

- **New LOGO! Base Modules with an Ethernet interface and SD card slot**

Two new LOGO! versions LOGO! 12/24RCE and LOGO! 230RCE, each with an RJ45 socket for Ethernet connection and an SD card slot, are commercially available.

- **Support of network communications**

LOGO! 0BA7 supports SIMATIC S7 communication across 10/100 Mbit/s TCP/IP Ethernet. A LOGO! 0BA7 can establish a maximum of eight S7 communication connections with other SIMATIC devices across Ethernet. Those SIMATIC devices include 0BA7 devices, SIMATIC S7 PLCs with Ethernet capability, and a SIMATIC HMI that supports Ethernet communication with networked S7 PLCs. Additionally, a LOGO! 0BA7 can support a maximum of one Ethernet connection with a PC with LOGO!Soft Comfort V7.0 installed.

- **Use of Ethernet for LOGO! 0BA7 ↔ PC communication**

Communication between a LOGO! 0BA7 and a PC takes place only on an Ethernet network.

- **SD card support**

LOGO! 0BA7 supports standard SD (Secure Digital) cards that support FAT12, FAT16, or FAT32 file system format. You can store and copy-protect a circuit program, with or without the data log of process data, from a LOGO! 0BA7 to an SD card, or copy a circuit program from the card to a LOGO! 0BA7.

---

**Note**

LOGO! 0BA7 only supports SD cards with a maximum memory capacity of 8 GB and a maximum data transfer speed of 48Mbits/s or 6MB/s (Class 6).

---

- **New menu commands**

LOGO! 0BA7 provides you with two new main menu commands respectively for network communication configuration and error diagnostics. Additionally, LOGO! 0BA7 provides a new menu command for configuration of the LOGO! start screen.

- **Ability to transfer I/O status information from a LOGO! 0BA7 to PC**

LOGO! 0BA7 supports transfer of I/O status data to the connected PC. You can view the I/O status information from LOGO!Soft Comfort. LOGO!Soft Comfort can save the I/O status information to a .CSV file on your PC.



- **Support of configuration of elements connected to UDFs (User-Defined Functions)**

LOGO!Soft Comfort V7.0 provides a new circuit program editor - the UDF editor. Circuit programs created in the UDF editor can be saved as individual UDF blocks for use in an existing or a new circuit program in LOGO!Soft Comfort. A UDF block is a preconfigured circuit program that you create. If the circuit program in your LOGO! 0BA7 contains a UDF block, you can edit the elements connected to this UDF block.

- **Support of data logging**

You can configure the Data Log function only from LOGO!Soft Comfort V7.0. The Data Log is used to record actual values of digital and analog I/O, digital and analog flags, and function blocks. If the circuit program in the LOGO! 0BA7 contains the Data Log block, you can configure the elements connected to it from the LOGO! 0BA7. You can select to store the data log either in the LOGO! 0BA7 or on an SD card. You can also save the data log to a .CSV file on your PC and open it with Microsoft Excel or with a text editor.

- **Extended real-time clock backup time**

LOGO! 0BA7 has a built-in real-time clock that supports a typical backup time of 20 days.

- **More connectors and memory space for the creation of the circuit program**

Four new connectors that represent network digital inputs/outputs and network analog inputs/outputs are available in a LOGO! 0BA7 if you have previously configured them from LOGO!Soft Comfort V7.0. In addition, you can now have up to 16 analog flags, 64 open connectors, 32 shift register bits, and a maximum program memory of 8400 bytes for up to 400 function blocks in your circuit program.

- **New special function blocks**

Five new special function blocks are available: Astronomical Clock, Stopwatch, Analog Filter, Max/Min, and Average Value.

## New features of the LOGO! 0BA6 device series

The following features were new for the LOGO! 0BA6 devices:

- A new expansion module named LOGO! AM2 RTD is commercially available. The module is equipped with two analog inputs for connection to PT100 and/or PT1000 sensors with the default temperature coefficient of  $\alpha = 0.003850$  for both sensor types. The LOGO! AM2 PT100 expansion module, however, only supports PT100 sensors.
- The LOGO! AM2 RTD module can automatically recognize the sensor type. It is thus unnecessary for you to make any configuration or setting to achieve this.
- Two new LOGO! versions LOGO! 24C and LOGO! 24Co (each with a built-in real-time clock) are commercially available.
- The LOGO! TD (Text Display) provides an additional display device for messages, and contains four cursor keys and four functions keys that can be used in the circuit program.
- An additional password protection function is available in the LOGO! TD (version ES4 or later) and can only be enabled when the LOGO! TD is used together with a LOGO! Base Module (version ES4 or later).
- The new LOGO! Battery Card and the LOGO! Combined Memory/Battery Card provide up to two years of backup time for the real-time clock. The new LOGO! Memory Card and the Combined Memory/Battery Card provide 32 Kbytes memory space.

- Additional optional analog inputs and fast digital inputs are available on some of the LOGO! 0BA6 Base Modules.
- LOGO! 0BA6 configuration menus can be displayed in one of ten supported languages. You have a configuration choice to specify the language for LOGO! menus.
- New instruction blocks are available: Pulse Width Modulator (PWM), Mathematic Instruction, and Mathematic Instruction Error Detection.
- Message texts can tick on and off the display; can include bar graphs, can switch between two character sets, and can be displayed on either the LOGO! onboard display, the LOGO! TD, or both. Full editing capabilities are available from LOGO!Soft Comfort; editing from the LOGO! Basic is limited to simple text. See topic "Compatibility (Page 38)" for further details.
- A modem interface between a PC and LOGO! 0BA6 Base Module is supported, and is configurable only from LOGO!Soft Comfort. LOGO! 0BA6 supports the following modems:
  - INSYS Modem 336 4 1
  - INSYS Modem 56K small INT 2.0You can also use other modems with LOGO! 0BA6 provided that these modems meet the requirements specified in the "Connecting modems (0BA6 only) (Page 61)" topic.
- USB PC cable between a PC and LOGO! Base Module is available as an option.
- Modem cable between a modem and LOGO! Base Module is available as an option.
- This series supports 0/4–20 mA for the AM2 AQ analog outputs.
- You can now have up to 200 program blocks in your circuit program.

## Additional differences compared to previous devices

### 0BA6 versus device series 0BA0 to 0BA5

- Extended set of reference parameters for function blocks
- Enhancements to up/down counter, hours counter, yearly timer and analog watchdog instruction blocks

### 0BA7 versus devices series 0BA0 to 0BA6

- Extended set of reference parameters for function blocks
- Enhancements to message text and weekly timer blocks
- Increase in the number of shift register function blocks

### LOGO! TD (version ES5 and later) versus LOGO! TD (version ES4 and earlier)

The ES5 and later versions of the LOGO! TD come with a LOGO! TD cable cover. You can use it to cover the TD cable connector on the left side of the LOGO! Base Module. For more information about the LOGO! TD cable cover, refer to the Product Information supplied with your LOGO! TD.

For more detailed information about the compatibility between different device series, refer to the topic "Compatibility (Page 38)".

## **Additional support**

Additional support is available on the Siemens website:

Siemens LOGO! website (<http://www.siemens.com/logo>)



# Table of contents

	<b>Preface .....</b>	<b>3</b>
<b>1</b>	<b>Getting started with LOGO!.....</b>	<b>13</b>
<b>2</b>	<b>LOGO! installation and wiring .....</b>	<b>29</b>
2.1	Modular LOGO! setup.....	32
2.1.1	Maximum LOGO! network setup (0BA7 only).....	32
2.1.2	Maximum setup with expansion and communication modules.....	34
2.1.3	Setup with different voltage classes .....	36
2.1.4	Compatibility.....	38
2.2	Installing/removing LOGO!.....	39
2.2.1	DIN rail mounting .....	40
2.2.2	Wall-mounting .....	43
2.2.3	Mounting the LOGO! TD .....	45
2.2.4	Labeling LOGO! .....	45
2.3	Wiring LOGO!.....	46
2.3.1	Connecting the power supply.....	46
2.3.2	Connecting the LOGO! TD power supply .....	48
2.3.3	Connecting LOGO! inputs.....	49
2.3.4	Connecting outputs .....	56
2.3.5	Connecting the EIB bus .....	58
2.3.6	Connecting the AS interface bus .....	59
2.3.7	Connecting modems (0BA6 only) .....	61
2.3.8	Connecting the Ethernet interface (0BA7 only) .....	62
2.4	Putting into operation .....	63
2.4.1	Switching the LOGO!/Power On .....	63
2.4.2	Putting a CM EIB/KNX into operation .....	66
2.4.3	Operating states.....	67
<b>3</b>	<b>Programming LOGO!.....</b>	<b>69</b>
3.1	Connectors.....	70
3.2	EIB inputs/outputs.....	73
3.3	Blocks and block numbers .....	74
3.4	From circuit diagram to LOGO! program .....	76
3.5	The four golden rules for operating LOGO! .....	79
3.6	Overview of LOGO! menus.....	81
3.7	Writing and starting the circuit program .....	83
3.7.1	Selecting programming mode .....	83
3.7.2	The first circuit program .....	85
3.7.3	Circuit program input.....	86
3.7.4	Assigning a circuit program name.....	90
3.7.5	Password for circuit program protection .....	91

3.7.6	Switching LOGO! to RUN mode .....	97
3.7.7	Second circuit program .....	100
3.7.8	Deleting a block.....	105
3.7.9	Deleting block groups.....	106
3.7.10	Correcting programming errors.....	107
3.7.11	Selecting analog output values for RUN/STOP transition .....	107
3.7.12	Defining the type of analog outputs .....	109
3.7.13	Deleting the circuit program and password.....	110
3.7.14	Summertime/wintertime conversion.....	111
3.7.15	Synchronization.....	116
3.8	Configuring additional functions for LOGO! (0BA7 only) .....	118
3.8.1	Configuring network settings.....	119
3.8.2	Configuring a UDF (User-Defined Function).....	120
3.8.3	Configuring the Data Log .....	121
3.8.4	Viewing network inputs/outputs .....	121
3.8.5	Changing LOGO! to normal/slave mode.....	123
3.8.6	Diagnosing errors from LOGO! .....	128
3.9	Memory space and circuit program size .....	130
<b>4</b>	<b>LOGO! functions .....</b>	<b>137</b>
4.1	Constants and connectors - Co .....	138
4.2	Basic functions list - GF .....	142
4.2.1	AND.....	143
4.2.2	AND with edge evaluation.....	144
4.2.3	NAND (not AND).....	145
4.2.4	NAND with edge evaluation .....	146
4.2.5	OR .....	147
4.2.6	NOR (not OR) .....	148
4.2.7	XOR (exclusive OR).....	149
4.2.8	NOT (Negation, Inverter).....	149
4.3	Special Functions.....	150
4.3.1	Designation of the inputs.....	150
4.3.2	Time response .....	151
4.3.3	Backup of the real-time clock.....	152
4.3.4	Retentivity.....	153
4.3.5	Parameter protection.....	153
4.3.6	Calculating the gain and offset of analog values .....	154
4.4	Special functions list - SF.....	156
4.4.1	On-delay.....	160
4.4.2	Off-delay.....	164
4.4.3	On-/Off-delay.....	166
4.4.4	Retentive on-delay .....	168
4.4.5	Wiping relay (pulse output) .....	170
4.4.6	Edge triggered wiping relay.....	172
4.4.7	Asynchronous pulse generator .....	175
4.4.8	Random generator .....	177
4.4.9	Stairway lighting switch.....	179
4.4.10	Multiple function switch .....	182
4.4.11	Weekly timer .....	185
4.4.12	Yearly timer .....	190

4.4.13	Astronomical clock (0BA7 only)	195
4.4.14	Stopwatch (0BA7 only)	198
4.4.15	Up/down counter	201
4.4.16	Hours counter	205
4.4.17	Threshold trigger	210
4.4.18	Analog threshold trigger	213
4.4.19	Analog differential trigger	216
4.4.20	Analog comparator	218
4.4.21	Analog watchdog	223
4.4.22	Analog amplifier	226
4.4.23	Latching relay	228
4.4.24	Pulse relay	229
4.4.25	Message texts	231
4.4.26	Softkey	243
4.4.27	Shift register	245
4.4.28	Analog multiplexer	248
4.4.29	Analog Ramp	251
4.4.30	PI controller	256
4.4.31	Pulse Width Modulator (PWM)	261
4.4.32	Mathematic instruction	265
4.4.33	Mathematic instruction error detection	268
4.4.34	Analog filter (0BA7 only)	271
4.4.35	Max/Min (0BA7 only)	273
4.4.36	Average value (0BA7 only)	276
<b>5</b>	<b>UDF (User-Defined Function) (0BA7 only)</b>	<b>279</b>
<b>6</b>	<b>Data Log (0BA7 only)</b>	<b>285</b>
<b>7</b>	<b>Configuring LOGO!</b>	<b>287</b>
7.1	Selecting parameter assignment mode	288
7.1.1	Parameters	290
7.1.2	Selecting the parameters	291
7.1.3	Modifying parameters	292
7.2	Setting the default values for LOGO!	294
7.2.1	Setting the time of day and date (LOGO! ... C)	295
7.2.2	Setting the display contrast and backlight choice	296
7.2.3	Setting the menu language	298
7.2.4	Setting the number of AIs in the LOGO! Basic	299
7.2.5	Setting the start screen	300
<b>8</b>	<b>Applicable cards</b>	<b>303</b>
8.1	Security function (CopyProtect)	305
8.2	Inserting and removing the card from LOGO!	307
8.3	Copying data from LOGO! to the card	309
8.4	Copying data from the card to LOGO!	311
<b>9</b>	<b>LOGO! software</b>	<b>313</b>
9.1	LOGO! software	313
9.2	Connecting LOGO! to a PC	315

<b>10</b>	<b>Applications .....</b>	<b>317</b>
<b>A</b>	<b>Technical data .....</b>	<b>319</b>
A.1	General technical data .....	319
A.2	Technical data: LOGO! 230... .....	321
A.3	Technical data: LOGO! DM8 230R and LOGO! DM16 230R .....	324
A.4	Technical data: LOGO! 24... .....	326
A.5	Technical data: LOGO! DM8 24 and LOGO! DM16 24 .....	328
A.6	Technical data: LOGO! 24RC... .....	330
A.7	Technical data: LOGO! DM8 24R and LOGO! DM16 24R .....	332
A.8	Technical data: LOGO! 12/24... LOGO! DM8 12/24R .....	334
A.9	Switching capacity/service life of the relay outputs.....	337
A.10	Technical data: LOGO! AM2 .....	338
A.11	Technical data: LOGO! AM2 PT100 .....	339
A.12	Technical data: LOGO! AM2 RTD .....	340
A.13	Technical data: LOGO! AM2 AQ.....	341
A.14	Technical data: CM EIB/KNX.....	342
A.15	Technical data: CM AS Interface .....	343
A.16	Technical data: LOGO!Power 12 V.....	344
A.17	Technical data: LOGO!Power 24 V.....	345
A.18	Technical data: LOGO! Contact 24/230.....	346
A.19	Technical data: LOGO! TD (Text Display) .....	347
A.20	Technical data: Battery information for LOGO! battery cards.....	348
<b>B</b>	<b>Determining the cycle time.....</b>	<b>349</b>
<b>C</b>	<b>LOGO! without display ("LOGO! Pure") .....</b>	<b>351</b>
<b>D</b>	<b>LOGO! menu structure .....</b>	<b>353</b>
D.1	LOGO! Basic .....	353
D.2	LOGO! TD .....	359
<b>E</b>	<b>Order numbers.....</b>	<b>363</b>
<b>F</b>	<b>Abbreviations .....</b>	<b>365</b>
	<b>Index.....</b>	<b>367</b>



# Getting started with LOGO!

## Here's LOGO!

LOGO! is a universal logic module made by Siemens that integrates:

- Controls
- Operator and display panel with background lighting
- Power supply
- Interface for expansion modules
- Interface for cards or cables, according to the device series:
  - If 0BA6, interface for a memory card, battery card, combined memory/battery card, LOGO! PC cable or USB PC cable
  - If 0BA7, interface for an SD card
- Interface for an optional text display (TD) module
- Pre-configured standard functions, for example, on- and off-delays, pulse relay and softkey
- Timers
- Digital and analog flags
- Inputs and outputs, according to the device type

LOGO! 0BA7 additionally integrates the following components:

- Interface for Ethernet communication
- PE terminal for connecting to earth ground
- Two LEDs for indicating Ethernet communication status

## What LOGO! can do for you

LOGO! offers solutions for domestic and installation engineering applications such as stairway lighting, external lighting, sun blinds, shutters, shop window lighting and more; switch cabinet engineering, as well as for mechanical and apparatus engineering such as gate control systems, air-conditioning systems, and rainwater pumps.

LOGO! can also be implemented for special control systems in conservatories or greenhouses, for control signal processing and, by connecting a communication module such as an AS-i module, for distributed local controlling of machines and processes.

Special versions without operator panel and display unit are available for series production applications in small machine, apparatus, switching cabinet and installation engineering.

### Which devices are available?

LOGO! Base Modules are available in two voltage classes:

- Class 1  $\leq$  24 V, i.e. 12 V DC, 24 V DC, 24 V AC
- Class 2  $>$  24 V, i.e. 115...240 V AC/DC

LOGO! Base Modules are available in two versions:

- **LOGO! Basic** (version with display): 8 inputs and 4 outputs
- **LOGO! Pure** (version without display): 8 inputs and 4 outputs

Each version is integrated into four (if 0BA6) or six (if 0BA7) subunits, is equipped with an expansion interface and LOGO! TD interface and provides 39 (if 0BA6) or 44 (if 0BA7) pre-configured standard and special function blocks for the creation of your circuit program.

---

#### Note

The LOGO! 0BA7 Base Modules currently released are only the LOGO! Basic version.

---

### Which expansion modules are available?

- LOGO! digital modules DM8... are available for operation with 12 V DC, 24 V AC/DC and 115...240 V AC/DC, and are equipped with four inputs and four outputs.
- LOGO! digital modules DM16... are available for operation with 24 V DC and 115...240 V AC/DC, and are equipped with eight inputs and eight outputs.
- LOGO! analog modules are available for operation with 24 V DC and some with 12 V DC, depending on the specific module. Each is equipped with two analog inputs, two PT100 inputs, two PT100/PT1000 inputs (either PT100 or PT1000 or one of each), or two analog outputs.

The digital/analog modules are integrated in two or four subunits. Each one is equipped with two expansion interfaces for connecting additional modules.

### Which display modules are available?

- LOGO! Basic
- LOGO! TD

## Features of the LOGO! TD

The LOGO! TD is available beginning with the 0BA6 series. It provides an additional display that is wider than the LOGO! Basic. It has four function keys that you can program in your circuit program as inputs. Like the LOGO! Basic, it has four cursor keys, an ESC key and an OK key that you can also program in your circuit program and use for navigation on the LOGO! TD.

You can create and download a power-up screen for the LOGO! TD from LOGO!Soft Comfort. This screen displays briefly when you initially power on the LOGO! TD. You can also upload the power-up screen from the LOGO! TD to LOGO!Soft Comfort.

The menus for the LOGO! TD are shown in Appendix section D.2. You configure the settings for the LOGO! TD independently from the LOGO! Basic. The settings can be different.

## Which communication modules are available?

- LOGO! communication module (CM) AS-Interface, which is described in more detail in a separate documentation.

The communication module has four virtual inputs and outputs, and acts as an interface between an AS-Interface system and a LOGO! system. The module enables four data bits to be transferred from the LOGO! Base Module to the AS-Interface system and vice versa.

- LOGO! communication module (CM) EIB/KNX, which is described in more detail in a separate documentation.

CM EIB/KNX is a communication module (CM) for connecting the LOGO! to the *EIB*.

As an interface to *EIB*, CM EIB/KNX makes it possible to communicate with other *EIB* devices. To do this, you store a configuration in the CM EIB/KNX that specifies the inputs/outputs of the LOGO! to the *EIB* bus that are to be mapped. You can interconnect the corresponding inputs/outputs using LOGO! functions.

## It's your choice

The various LOGO! Base Modules, expansion modules, LOGO! TD and communication modules offer you a highly flexible and adaptive system to suit your specific tasks.

The LOGO! system offers you many solutions such as for small domestic installations, simple automation tasks, and even complex engineering tasks involving its integration into a bus system (e.g. communication module AS-Interface).

---

**Note**

The LOGO! Base Module may only be equipped with expansion modules of the same voltage class. Mechanical encoding pins in the housing prevent you from connecting devices of a different voltage class.

Exception: The interface on the left side of an analog module or communication module is galvanically isolated.

This type of expansion module can therefore be connected to devices of a different voltage class (Page 36).

A LOGO! TD, if used, can be connected to only one LOGO! Base Module.

Each LOGO! Base Module supports the following connections for the creation of the circuit program, regardless of the number of connected modules:

- Digital inputs I1 to I24
- Analog inputs AI1 to AI8
- Digital outputs Q1 to Q16
- Analog outputs AQ1 to AQ2
- Digital flag blocks M1 to M27:
  - M8: Startup flag
  - M25: Backlight flag: LOGO! onboard display
  - M26: Backlight flag: LOGO! TD
  - M27: Message text character set flag
- Analog flag blocks: dependent upon the device series
  - 0BA6: AM1 to AM6
  - 0BA7: AM1 to AM16
- Shift register bits: dependent upon the device series
  - 0BA6: S1 to S8
  - 0BA7: S1.1 to S4.8 (32 shift register bits)
- 4 cursor keys
- Blank outputs: dependent upon the device series
  - 0BA6: X1 to X16
  - 0BA7: X1 to X64

LOGO! 0BA7 additionally supports display of the following network digital/analog inputs and outputs if you have previously configured them in the circuit program in LOGO!Soft Comfort V7.0 and downloaded the program to the 0BA7 device:

- 64 network digital inputs: NI1 to NI64
  - 32 network analog inputs: NAI1 to NAI32
  - 64 network digital outputs: NQ1 to NQ64
  - 16 network analog outputs: NAQ1 to NAQ16
-

The LOGO! structure

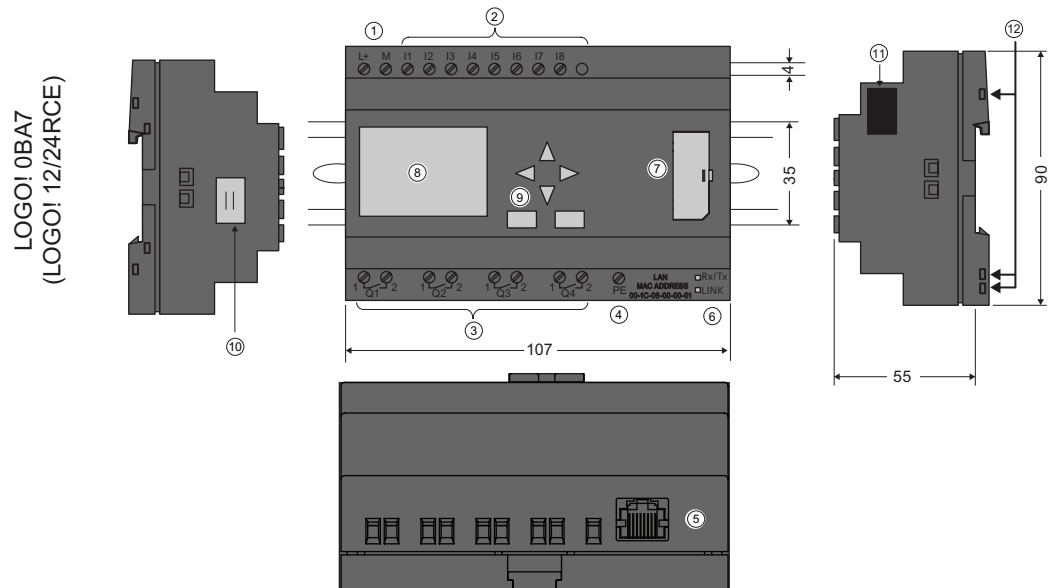
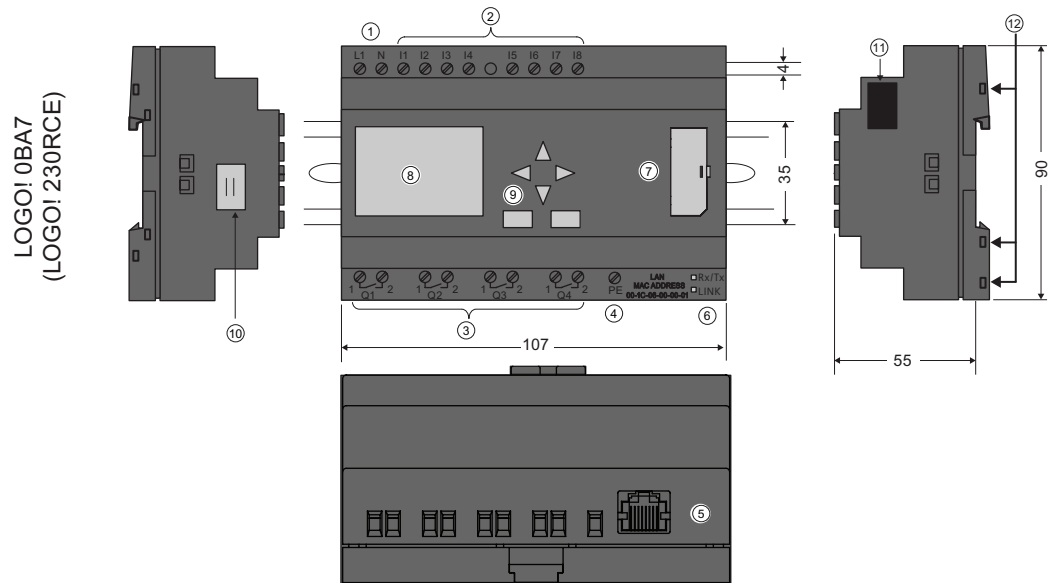

- |   |   |
|---|---|
| ① Power supply  | ② Inputs                                      |
| ③ Outputs   | ④ PE terminal, for connecting to earth ground |
| ⑤ RJ45 socket, for connection to Ethernet (10/100 Mbit/s) | ⑥ Ethernet communication status LEDs          |
| ⑦ SD card slot with cap                                   | ⑧ LCD   |
| ⑨ Control panel   | ⑩ LOGO! TD cable connector                    |
| ⑪ Expansion interface                                     | ⑫ Mechanical coding sockets                   |

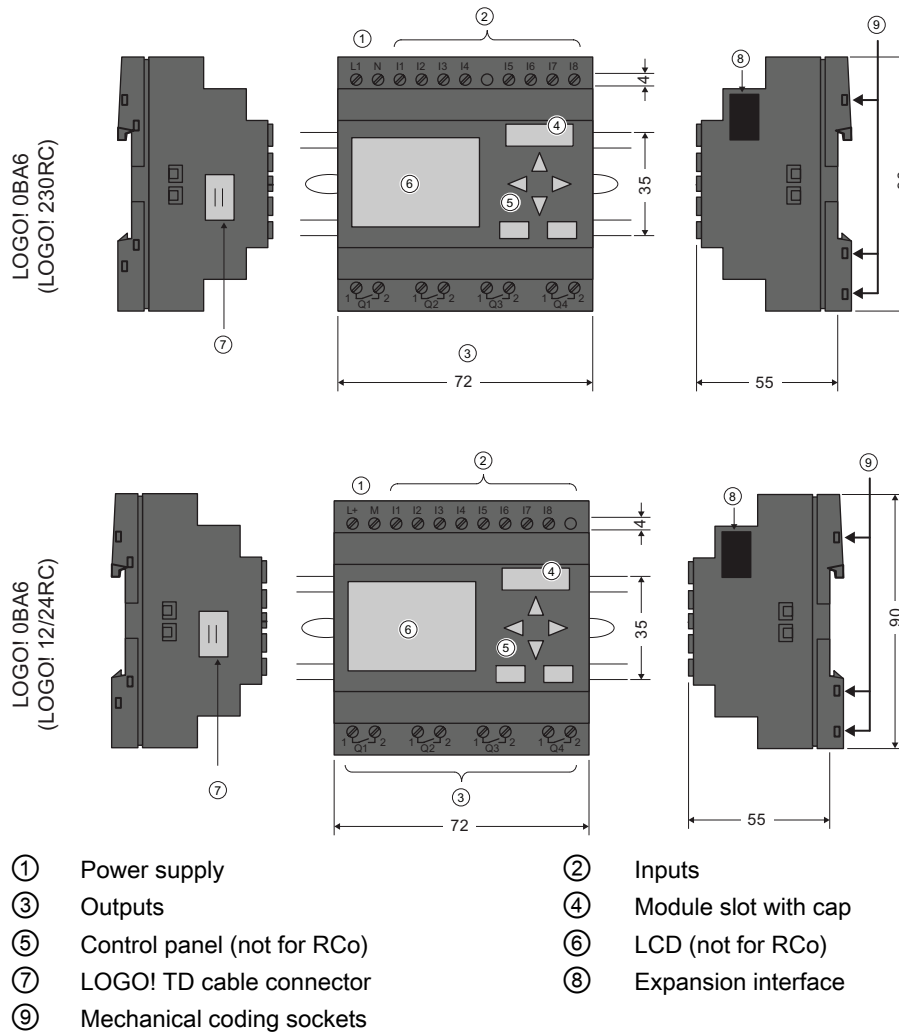

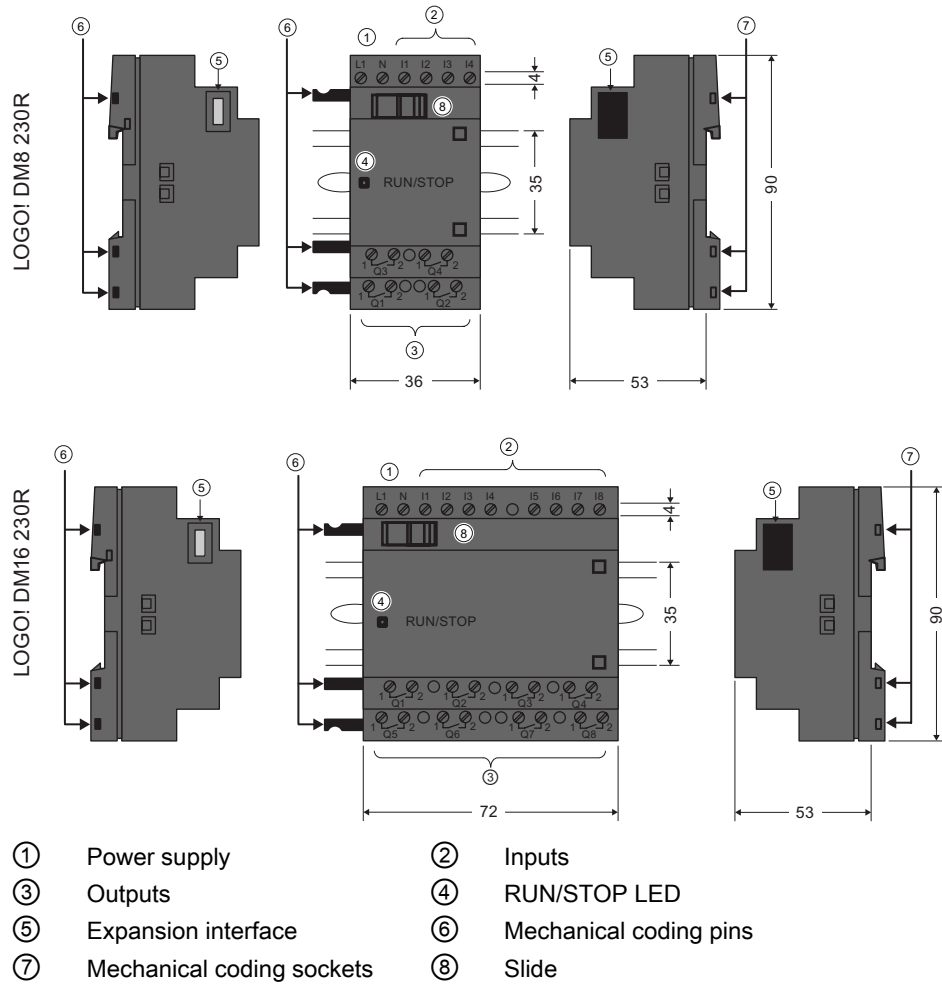

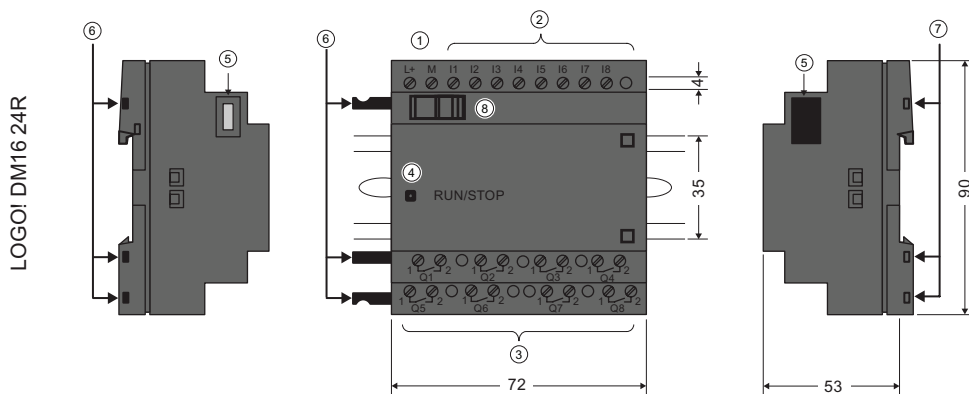
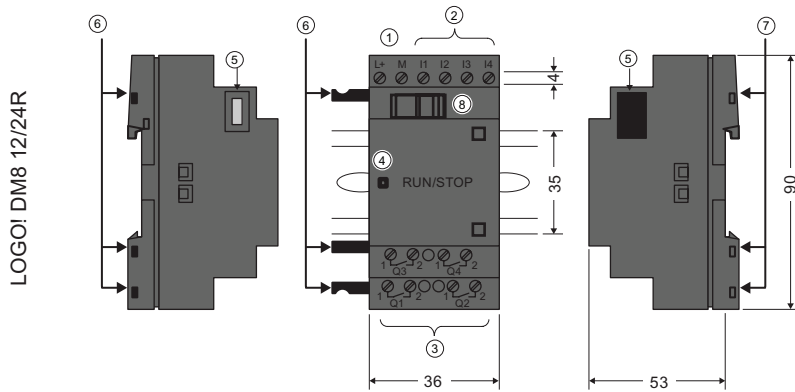

- |                             |                          |
|-----------------------------|--------------------------|
| ① Power supply              | ② Inputs                 |
| ③ Outputs                   | ④ RUN/STOP LED           |
| ⑤ Expansion interface       | ⑥ Mechanical coding pins |
| ⑦ Mechanical coding sockets | ⑧ Slide                  |

**LOGO! AM2**

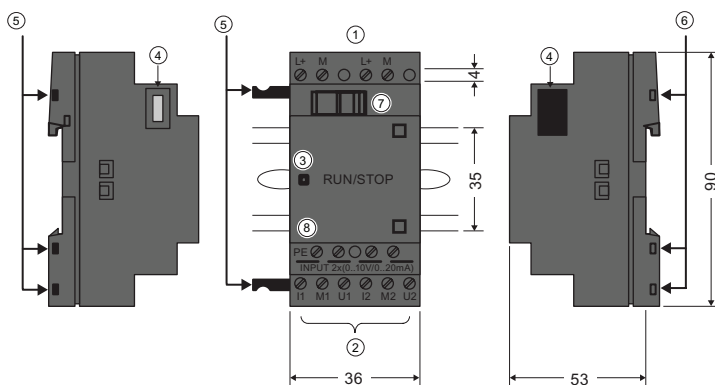

- |                          |  |
|--------------------------|--|
| ① Power supply           | ② Inputs   |
| ③ RUN/STOP LED           | ④ Expansion interface  |
| ⑤ Mechanical coding pins | ⑥ Mechanical coding sockets  |
| ⑦ Slide                  | ⑧ PE terminal, for connecting to earth ground and the shielding of analog measuring cables |



**LOGO! AM2 AQ (0 ... 10 V DC or 0/4 ... 20 mA)**

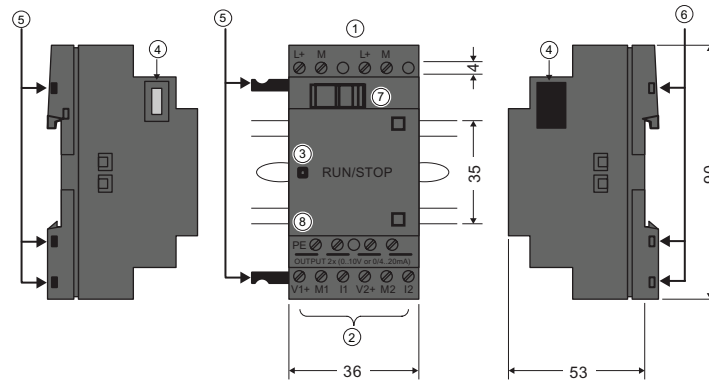

- |                          |   |
|--------------------------|---|
| ① Power supply           | ② Outputs                                     |
| ③ RUN/STOP LED           | ④ Expansion interface                         |
| ⑤ Mechanical coding pins | ⑥ Mechanical coding sockets                   |
| ⑦ Slide                  | ⑧ PE terminal, for connecting to earth ground |

**LOGO! CM EIB/KNX**

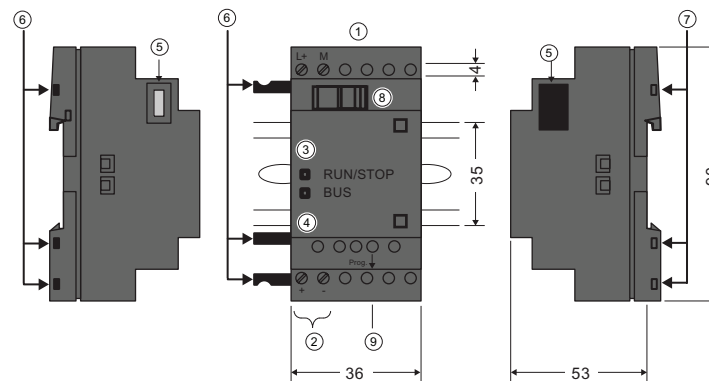

- |                             |                                     |
|-----------------------------|-------------------------------------|
| ① Power supply              | ② EIB bus connection                |
| ③ RUN/STOP LED              | ④ LED for status display of EIB/KNX |
| ⑤ Expansion interface       | ⑥ Mechanical coding pins            |
| ⑦ Mechanical coding sockets | ⑧ Slide                             |
| ⑨ Programming button        |                                     |

## LOGO! TD

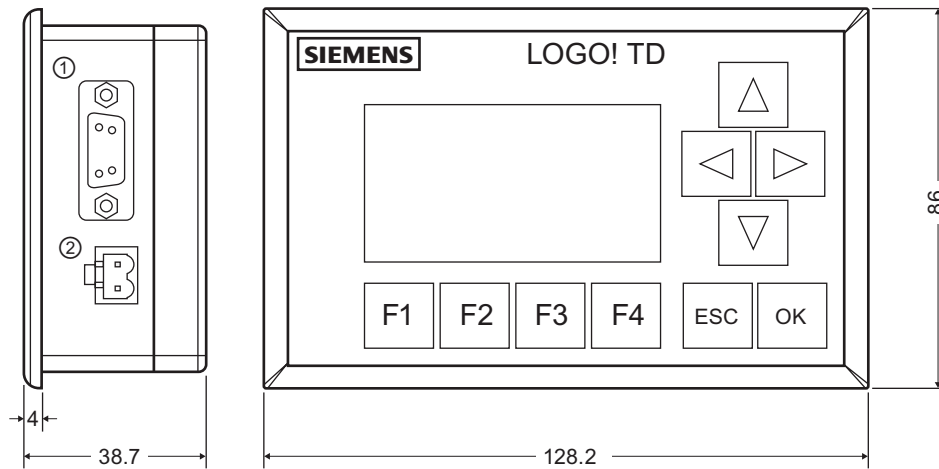

- ① Communication interface
- ② Power supply









The LOGO! TD includes a wider display area than the LOGO! onboard display. It includes four programmable cursor keys, four programmable function keys, and an ESC and an OK key. You use the included LOGO! TD cable to connect from the communication interface on the right side of the LOGO! TD to the corresponding interface on the left side of the LOGO! Base Module.

## How to identify LOGO!

The LOGO! identifier informs you of various properties:



- 12/24: 12/24 V DC version
- 230: 115...240 V AC/DC version
- R: Relay outputs (without R: solid-state outputs)
- C: Integrated real-time clock
- E: Ethernet interface
- o: Version without display ("LOGO! Pure")
- DM: Digital module
- AM: Analog module
- CM: Communication module (e.g. EIB/KNX module)
- TD: Text Display

## Symbols

	<p>Version with display unit is equipped with 8 inputs, 4 outputs and 1 Ethernet interface</p>
	<p>Version with display unit is equipped with 8 inputs and 4 outputs</p>
	<p>Version without display unit is equipped with 8 inputs and 4 outputs</p>
	<p>The digital module is equipped with 4 digital inputs and 4 digital outputs</p>
	<p>The digital module is equipped with 8 digital inputs and 8 digital outputs</p>
	<p>The analog module is equipped with 2 analog inputs or 2 analog outputs, according to the device type</p>
	<p>The communication module (CM); for example, AS Interface is equipped with 4 virtual inputs and 4 virtual outputs</p>
	<p>The LOGO! TD</p>

## Versions



The following LOGO! versions are available:

Symbol	Designation	Supply voltage	Inputs	Outputs	Properties
 (0BA7)	LOGO! 12/24RCE	12/24V DC	8 digital <sup>1)</sup>	4 relays (10 A)	
	LOGO! 230RCE	115 ... 240 V AC/DC	8 digital	4 relays (10A)	
	LOGO! 12/24RC	12/24 V DC	8 digital <sup>1)</sup>	4 relays (10 A)	
	LOGO! 24	24 V DC	8 digital <sup>1)</sup>	4 solid state 24V / 0.3A	no clock
	LOGO! 24C	24 V DC	8 digital <sup>1)</sup>	4 solid state 24V / 0.3A	
	LOGO! 24RC <sup>3)</sup>	24 V AC/ 24 V DC	8 digital	4 relays (10A)	
	LOGO! 230RC <sup>2)</sup>	115 ... 240 V AC/DC	8 digital	4 relays (10A)	
	LOGO! 12/24RCo	12/24 V DC	8 digital <sup>1)</sup>	4 relays (10A)	no display unit no keyboard
	LOGO! 24o	24 V DC	8 digital <sup>1)</sup>	4 solid state 24 V / 0.3A	no display unit no keyboard no clock
	LOGO! 24Co	24 V DC	8 digital <sup>1)</sup>	4 solid state 24 V / 0.3A	no display unit no keyboard
	LOGO! 24RCo <sup>3)</sup>	24 V AC / 24 V DC	8 digital	4 relays (10A)	no display unit no keyboard
	LOGO! 230RCo <sup>2)</sup>	115 ... 240 V AC/DC	8 digital	4 relays (10A)	no display unit no keyboard

- 1) Of those can be used alternatively: 4 analog inputs (0 ... 10V) and 4 fast digital inputs.
- 2) 230 V AC versions: Two groups consisting of 4 inputs each. Each input within a group must be connected to the same phase. It is possible to interconnect groups with a different phase.
- 3) The digital inputs can be operated with P or N action.

## Expansion modules

The following expansion modules can be connected to LOGO!:

Symbol	Name	Power supply	Inputs	Outputs
	LOGO! DM8 12/24R	12/24 V DC	4 digital	4 relays (5A)
	LOGO! DM8 24	24 V DC	4 digital	4 solid state 24V / 0.3A
	LOGO! DM8 24R <sup>3)</sup>	24 V AC/DC	4 digital	4 relays (5A)
	LOGO! DM8 230R	115 ... 240 V AC/DC	4 digital <sup>1)</sup>	4 relays (5A)
	LOGO! DM16 24	24 V DC	8 digital	8 solid state 24V / 0.3A
	LOGO! DM16 24R	24 V DC	8 digital	8 relays (5A)
	LOGO! DM16 230R	115 ... 240 V AC/DC	8 digital <sup>4)</sup>	8 relays (5A)
	LOGO! AM2	12/24 V DC	2 analog 0 ... 10V or 0/4 ... 20mA <sup>2)</sup>	None
	LOGO! AM2 PT100	12/24 V DC	2 PT100 <sup>6)</sup> -50 degrees C to +200 degrees C	None
	LOGO! AM2 RTD	12/24 V DC	2 PT100 or 2 PT1000 or 1 PT100 plus 1 PT1000 <sup>6)</sup> -50 degrees C to +200 degrees C	None
	LOGO! AM2 AQ	24 V DC	None	2 analog 0 ... 10 V DC or 0/4...20mA <sup>5)</sup>

- 1) Different phases are not allowed within the inputs.
- 2) 0 ... 10 V, 0/4 ... 20 mA can be connected optionally.
- 3) Digital inputs can be operated either with P or with N action.
- 4) Two groups consisting of 4 inputs each. Each input within a group must be connected to the same phase. It is possible to interconnect groups with a different phase.
- 5) 0 ... 10 V, 0/4 ... 20 mA can be connected optionally. The 0/4 ... 20 mA current output is only possible with the LOGO! 0BA6 Base Module.
- 6) Sensors supported by the LOGO! AM2 RTD module are the PT100 and PT1000 sensors with a default temperature coefficient  $\alpha$  of 0.003850.

## Communication modules

The following communication modules can be connected to LOGO!:

Symbol	Name	Power supply	Inputs	Outputs
	LOGO! CM AS Interface	30 V DC	the next four inputs after the physical inputs of LOGO! (In ... In+3)	the next four outputs after the physical outputs of LOGO! (Qn ... Qn+3)
	LOGO! CM EIB/KNX	24 V AC/DC	max. 16 virtual digital inputs (I); max. 8 virtual analog inputs (AI)	max. 12 virtual digital outputs (Q); max. 2 virtual analog outputs (AQ)

## Text Display Module

The following LOGO! TD module is available:

Symbol	Name	Supply voltage	Display
	LOGO! TD	24 V AC/DC 12 V DC	LCD (128 x 64) 4-row display

## Certification and approvals

LOGO! is certified to cULus and FM.

- cULus Haz. Loc.  
Underwriters Laboratories Inc. (UL) to
  - UL 508 (Industrial Control Equipment)
  - CSA C22.2 No. 142 (Process Control Equipment)
  - UL 1604 (Hazardous Location)
  - CSA-213 (Hazardous Location)APPROVED for use in  
Class I, Division 2, Group A, B, C, D Tx  
Class I, Zone 2, Group IIC Tx
- FM Approval  
Factory Mutual Research (FM) to  
Approval Standard Class Number 3611, 3600, 3810  
APPROVED for use in  
Class I, Division 2, Group A, B, C, D Tx  
Class I, Zone 2, Group IIC Tx

---

### Note

You will find current approvals on the rating plate of the relevant module.

---

LOGO! is issued with the CE Certificate of Conformity. It is compliant with IEC 60730-1 and IEC 61131-2 and interference-proof to EN 55011, Limit Class B.

Marine certification has been requested.

- ABS (American Bureau of Shipping)
- BV (Bureau Veritas)
- DNV (Det Norske Veritas)
- GL (Germanischer Lloyd)
- LRS (Lloyds Register of Shipping)
- Class NK (Nippon Kaiji Kyokai)

LOGO! modules are therefore suitable for use in industrial and residential areas. Use in Class I, Division 2, Group A, B, C and D locations or in non-hazardous locations is supported.

## ID for Australia



Our products carrying the label shown at the side are compliant with AS/NZS 2064:1997 (Class A) standard.

## ID for Korea



Our products carrying the label shown at the side are compliant with Korean standards.

 **WARNING**

Risk of death, personal injury or property damage can occur if you do not follow safety precautions for hazardous locations.

In potentially explosive atmospheres, do not disconnect connectors when the system is in RUN. Always switch off the power supply to LOGO! and its components before you disconnect any connectors or components.

Substitution of components can impair suitability for Class I, Division 2 locations. Combinations of equipment are subject to investigation by the local authority having jurisdiction at the time of the installation.

## Recycling and Disposal

LOGO! units can be fully recycled, due to their low-pollutant equipment. Contact a certified electronic waste disposal center for environmentally acceptable recycling and disposal of your old devices.



# LOGO! installation and wiring

## General guidelines

Please note the following guidelines for installing and wiring your LOGO!:

- Always ensure that the wiring of your LOGO! is compliant with current rules and standards. Also, conform with all national and regional regulations when you install and operate the devices. For information on standards and regulations that apply to your specific case, contact your local authorities.
- Always switch off power before you wire or install/remove a module.
- Always use cables with appropriate conductor cross-sections for the relevant current. You can wire LOGO! with cable conductor cross-sections (Page 46) from 1.5 mm<sup>2</sup> to 2.5 mm<sup>2</sup>.
- Do not exceed the screw torque of the terminals. The maximum torque is: 0.5 Nm.
- Keep the cabling as short as possible. If longer cables are necessary, you should use shielded versions. You should always route your cables in pairs: i.e. one neutral conductor plus one phase conductor or signal line.
- Always keep separate:
  - The AC wiring
  - High-voltage DC circuits with high-frequency switching cycles
  - Low-voltage signal wiring
  - The EIB bus cable may also be laid in parallel to other signal lines
- Ensure that the wires are installed with appropriate strain relief.
- Provide a suitable lightning surge arrester for cables installed in hazardous areas.
- Do not connect an external power supply in parallel to the output load of a DC output. This could develop a reverse current at the output if you have not installed a diode or similar barrier device.
- Reliable functioning of the equipment is only ensured with certified components!

---

### Note

LOGO! devices may only be installed and wired by skilled personnel who are familiar with and follow general engineering rules and relevant regulations and standards.

---

## What you must note when installing

LOGO! is designed for fixed and enclosed installation in the housing or the control cabinet.

### **WARNING**

Attempts to install or wire LOGO! or related equipment with power applied could cause electric shock or faulty operation of the equipment. Failure to disable all power to LOGO! and related equipment during installation or removal procedures could result in death or serious injury to personnel, and/or damage to equipment.

Always follow appropriate safety precautions and ensure that power to LOGO! is disabled before attempting to install or remove LOGO! or related equipment.

Modules of a LOGO! are open facilities. This means that you must install LOGO! only in a housing or cabinet.

Allow access to the housings or cabinets only with the use of a key or a tool and only by authorized or approved personnel.

It is permissible to operate LOGO! from the front at any time.

## Safety of electronic control equipment

### Introduction

The notes below apply regardless of the type or manufacturer of the electronic control.

### Reliability

Maximum reliability of LOGO! devices and components is achieved by implementing extensive and cost-effective measures during development and manufacture.

This includes the following:

- Use of high-quality components
- Design of all circuits for worst-case scenarios
- Systematic and computer-aided testing of all components
- Burn-in of all large-scale integrated circuits (for example, processors, memory and so on)
- Prevention of static charge when handling MOS ICs
- Visual checks at different stages of manufacture
- Continuous heat-run test at elevated ambient temperature over a period of several days
- Careful computer-controlled final testing
- Statistical evaluation of all returned systems and components to enable the immediate initiation of suitable corrective measures
- Monitoring of major control components, using online tests (cyclic interrupt for the CPU, etc.)

These measures are referred to as basic measures.

### **Carrying out tests**

You must ensure safety in your plant.

Before finally commissioning a system, carry out complete functional testing as well as all the necessary safety testing.

Also, test for any predictable faults that can occur. This means that you will avoid any danger to the plant or to people during operation.

### **Risks**

In all cases where the occurrence of failures can result in material damage or injury to persons, take special measures to enhance the safety of the installation - and the application. System-specific and special regulations exist for such applications. Follow these regulations exactly when installing the control system (for example, VDE 0116 for burner control systems).

For electronic control equipment with a safety function, the measures that you must take to prevent or rectify faults are based on the risks involved in the installation. Beyond a certain degree of hazard the basic measures mentioned above are not sufficient and you must take additional safety measures for the controller.

### **Important information**

Follow the instructions in the operating manual exactly. Incorrect handling can render measures intended to prevent dangerous faults ineffective, or generate additional sources of danger.

## 2.1 Modular LOGO! setup

### 2.1.1 Maximum LOGO! network setup (0BA7 only)

#### Maximum LOGO! 0BA7 network setup

LOGO! 0BA7 supports SIMATIC S7 communication via 10/100 Mbit/s TCP/IP Ethernet.

A LOGO! 0BA7 device can support a maximum of **8+1** network connections as described below:

- **8:** A maximum of eight TCP/IP-based S7 communication connections with the following devices:
  - Additional LOGO! 0BA7 devices
  - SIMATIC S7 PLCs with Ethernet functionality
  - A maximum of one SIMATIC HMI that supports Ethernet communication with networked S7 PLCs
- **1:** A maximum of one TCP/IP Ethernet connection between a LOGO! Base Module and a PC with LOGO!Soft Comfort V7.0 installed

---

#### Note

You can only construct a LOGO! 0BA7 network topology using LOGO!Soft Comfort V7.0.

---

A typical LOGO! 0BA7 network setup is shown below:

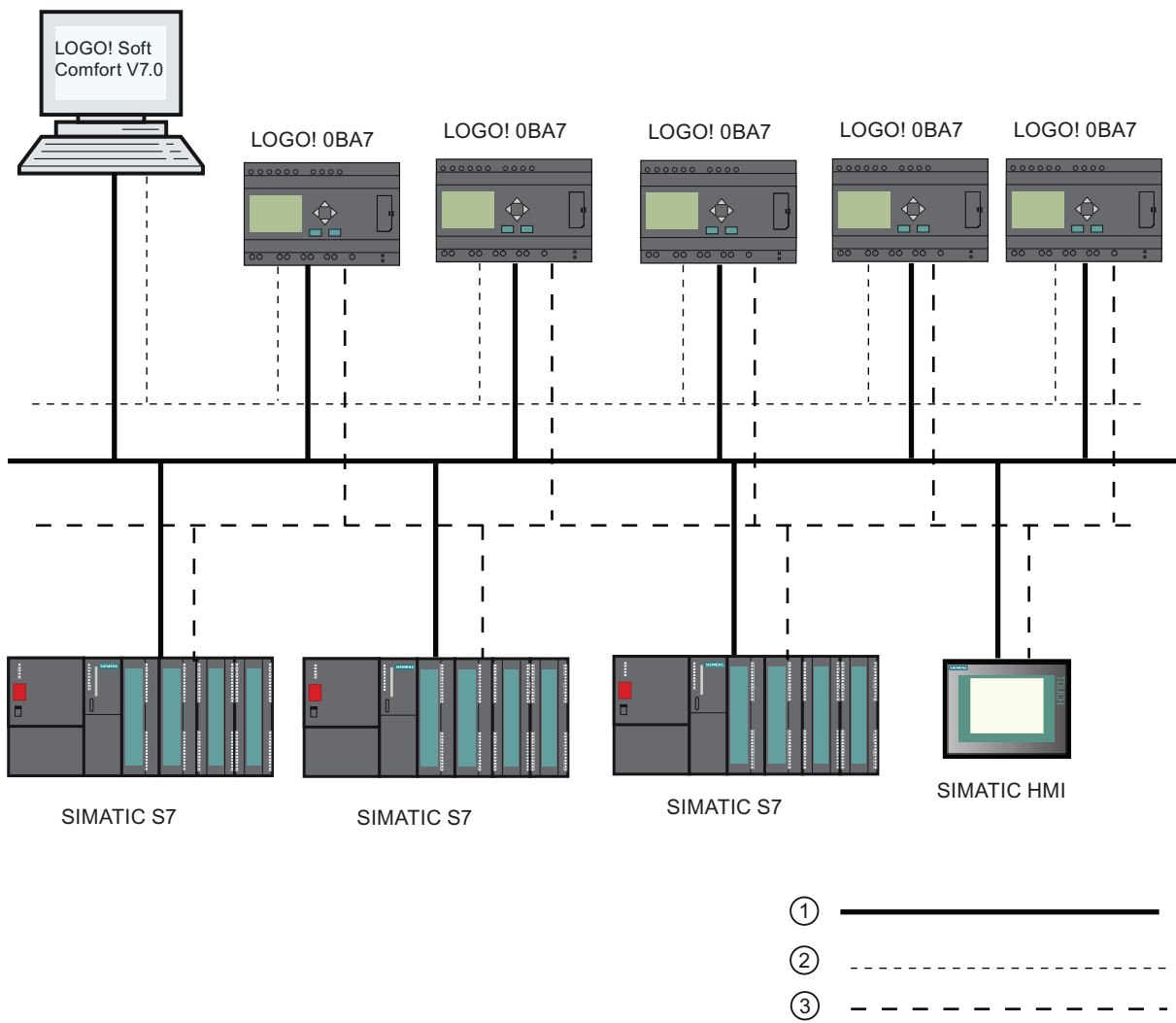

- ① Physical Ethernet connections
- ② Logical connection for communication between LOGO! and PC (by TCP/IP-based Ethernet)
- ③ Logical connections for S7 communication between SIMATIC devices (with S7 protocol over TCP/IP)

2.1.2 Maximum setup with expansion and communication modules

LOGO! supports a maximum of 24 digital inputs, 8 analog inputs, 16 digital outputs, and 2 analog outputs (Page 13). You can achieve the maximum setup in different ways as shown below:

Maximum setup of a LOGO! *with* analog inputs onboard - four in use

LOGO! Base Module, 4 digital modules and 3 analog modules (example)

I1, I2, I3 .. I6, I7, I8 AI3, AI4, AI1, AI2	I9..I12	I13..I16	I17..I20	I21..I24	AI5, AI6	AI7, AI8	
LOGO! Base Module	LOGO! DM8	LOGO! DM8	LOGO! DM8	LOGO! DM8	LOGO! AM2	LOGO! AM2	LOGO! AM2 AQ
Q1..Q4	Q5..Q8	Q9..Q12	Q13..Q16				AQ1, AQ2

Maximum setup of a LOGO! *with* analog inputs onboard - two in use

LOGO! Base Module, 4 digital modules and 4 analog modules (example)

I1, I2, I3 .. I6, I7, I8 AI1, AI2	I9..I12	I13..I16	I17..I20	I21..I24	AI3, AI4	AI5, AI6	AI7, AI8	
LOGO! Base Module	LOGO! DM8	LOGO! DM8	LOGO! DM8	LOGO! DM8	LOGO! AM2	LOGO! AM2	LOGO! AM2	LOGO! AM2 AQ
Q1..Q4	Q5..Q8	Q9..Q12	Q13..Q16					AQ1, AQ2

Maximum setup of a LOGO! *without* analog inputs onboard (LOGO! 24 RC/RCo, LOGO! 230RC/RCo, and LOGO! 230RCE)

LOGO! Base Module, 4 digital modules and 5 analog modules (example)

I1 . . . . . I8	I9..I12	I13..I16	I17..I20	I21..I24	AI1, AI2	AI3, AI4	AI5, AI6	AI7, AI8	
LOGO! Base Module	LOGO! DM8	LOGO! DM8	LOGO! DM8	LOGO! DM8	LOGO! AM2	LOGO! AM2	LOGO! AM2	LOGO! AM2	LOGO! AM2 AQ
Q1..Q4	Q5..Q8	Q9..Q12	Q13..Q16						AQ1, AQ2

For LOGO! 12/24RCE, LOGO! 12/24 RC/RCo, LOGO! 24/24o, LOGO! 24C/24Co modules, you can configure whether the module uses two or four of the four possible analog inputs. AI inputs are numbered consecutively depending on how many you configure the LOGO! Base Module to use. If you configure two inputs, they are numbered AI1 and AI2, and correspond to the I7 and I8 input terminals. Subsequent AI expansions modules would begin numbering at AI3. If you configure four inputs, they are numbered AI1, AI2, AI3, and AI4, and correspond to I7, I8, I1, and I2 in that order. Subsequent AI expansions modules would begin numbering at AI5. See topics "Constants and connectors - Co (Page 138)" and "Setting the number of AIs in the LOGO! Basic (Page 299)".

### **High-speed/optimal communication performance**

For optimal and high-speed communication performance between the LOGO! Base Module and the various modules, we recommend that you install the digital modules first, then the analog modules (examples above). (The special function PI controller is an exception: the AI used for the value PV should be on the LOGO! Base Module or an analog input module adjacent to the LOGO! Base Module).

Siemens **recommends** that you position the CM AS Interface on the far right. (If the AS Interface voltage fails, communication between the LOGO! system and expansion modules that are arranged to the right of the LOGO! CM AS Interface expansion module is interrupted).

The LOGO! TD module is installed separately. You connect it to the LOGO! Base Module with the included LOGO! TD cable.

---

#### **Note**

CM EIB/KNX must always be installed as the last module on the right of LOGO!.

No further interface modules may be connected to the CM EIB/KNX.

---

### 2.1.3 Setup with different voltage classes

#### Rules

Digital modules can only be directly connected to devices of the same voltage class.

You can connect analog and communication modules to devices of any voltage class.

You can replace two similar DM8 expansion modules by one appropriate DM16 expansion module (and vice versa) without having to change the circuit program.

---

#### Note

Two DM8 12/24R can be replaced by one DM16 24R only if operated with a power supply of 24 V DC.

Two DM8 24R can be replaced by one DM16 24R only if operated with DC and P action.

---

#### Overview: Connecting an expansion module to the LOGO! Base Module

In the following tables, "X" means that the connection is possible; "-" means that the connection is not possible.

LOGO! Base Module	Expansion modules					
	DM8 12/24R, DM16 24R	DM8 24, DM16 24	DM 8 24R	DM8 230R, DM16 230R	AM2, AM2 PT100, AM2 RTD, AM2 AQ	CM
LOGO! 12/24RCE	x	x	x	-	x	x
LOGO! 230RCE	-	-	-	x	x	x
LOGO! 12/24RC	x	x	x	-	x	x
LOGO! 24	x	x	x	-	x	x
LOGO! 24C	x	x	x	-	x	x
LOGO! 24RC	x	x	x	-	x	x
LOGO! 230RC	-	-	-	x	x	x
LOGO! 12/24RCo	x	x	x	-	x	x
LOGO! 24o	x	x	x	-	x	x
LOGO! 24Co	x	x	x	-	x	x
LOGO! 24RCo	x	x	x	-	x	x
LOGO! 230RCo	-	-	-	x	x	x



**Overview: Connecting an additional expansion module to an expansion module**

Expansion module	Additional expansion modules					
	DM8 12/24R, DM16 24R	DM8 24, DM16 24	DM8 24R	DM8 230R, DM16 230R	AM2, AM2 PT100, AM2 RTD, AM2 AQ	CM
DM8 12/24R, DM16 24R	x	x	x	-	x	x
DM8 24, DM16 24	x	x	x	-	x	x
DM8 24 R	x	x	x	-	x	x
DM8 230R, DM16 230R	-	-	-	x	x	x
AM2, AM2 PT100, AM2 RTD, AM2 AQ	x	x	x	-	x	x
CM AS Interface	x	x	x	-	x	x
CM EIB/KNX	-	-	-	-	-	-

## **2.1.4 Compatibility**

The LOGO! TD module can only be used with equipment series 0BA6 or 0BA7.

The ES7 version of the LOGO! TD provides new menu commands for network communication and error diagnostics that specifically relate to the LOGO! 0BA7 device. The ES7 LOGO! TD additionally provides a "Card" menu as in the LOGO! Base Module for copying the circuit program between the LOGO! 0BA7 and an SD card.

The LOGO! TD (version ES7) is fully compatible with LOGO! 0BA7. The LOGO! TD (version ES6 or earlier) is fully compatible with LOGO! 0BA6.

You can use an ES7 LOGO! TD with a LOGO! 0BA6, but the new ES7 functions for LOGO! 0BA7 will not be applicable.

You can use an ES6 or earlier version of the LOGO! TD with a LOGO! 0BA7, but you will not have the new functions for LOGO! 0BA7. You will only have the functions that were available for LOGO! 0BA6.

You cannot edit message texts from the LOGO! Base Module that contain any of the following parameters:

- Par
- Time
- Date
- EnTime
- EnDate

You can only edit such message texts from LOGO!Soft Comfort.

When using the LOGO! AM2 AQ analog module with equipment series 0BA4 or 0BA5, the functions are limited to the ones available on this equipment. You cannot use the module with equipment series 0BA3 or earlier.

All other expansion modules are completely compatible with the LOGO! Base Modules of equipment series 0BA3, 0BA4, 0BA5, 0BA6, and 0BA7.

## 2.2 Installing/removing LOGO!

### Dimensions

The LOGO! installation dimensions are compliant with DIN 43880.

LOGO! can be snap-mounted to 35 mm DIN rails to EN 50022 or on the wall.

LOGO! width:

- LOGO! TD has a width of 128.2 mm, which corresponds to 8 subunits
- LOGO! 0BA6 Base Modules have a width of 72 mm, which corresponds to 4 subunits.  
LOGO! 0BA7 Base Modules have a width of 107 mm, which corresponds to 6 subunits.
- LOGO! expansion modules have a width of 36 mm or 72 mm (DM16...), which corresponds to 2 or 4 subunits

---

#### **Note**

The figures below show you an example of the installation and removal of a LOGO! 230RCE/LOGO!230RC and a digital module. The measures shown apply to all other LOGO! Base Module versions and expansion modules.

---

 <b>WARNING</b>
--

Always switch off power before you remove or insert an expansion module.
--

### 2.2.1 DIN rail mounting

#### Mounting

How to **mount** a LOGO! Base Module **and** a digital module onto a DIN rail:

1. Hook the LOGO! Base Module onto the rail.
2. Push down the lower end to snap it on. The mounting interlock at the rear must engage.

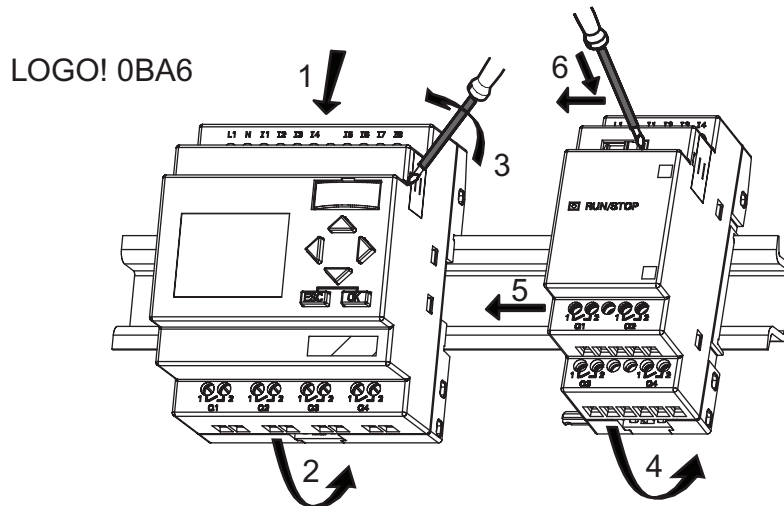
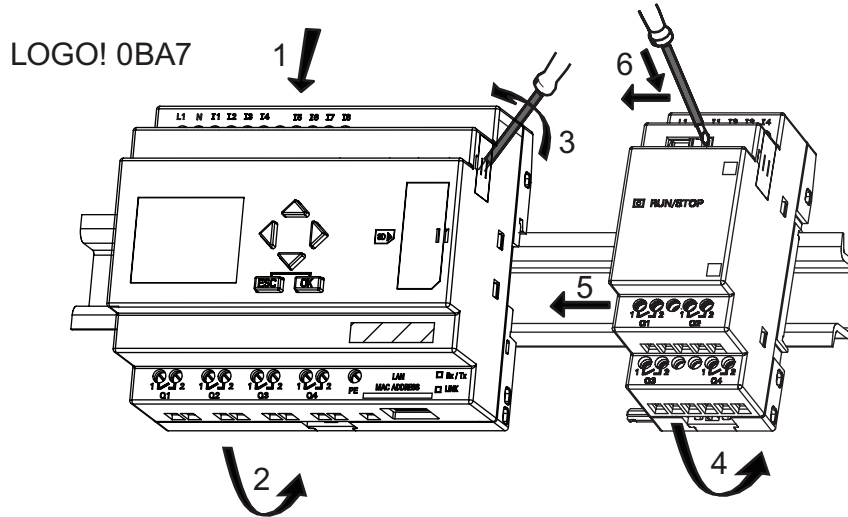

3. On the right side of the LOGO! Base Module/LOGO! expansion module, remove the connector cap.
4. Place the digital module onto the DIN rail on the right-hand side of the LOGO! Base Module.

- Slide the digital module towards the left until it contacts the LOGO! Base Module.
- Using a screwdriver, push the interlock to the left. In its end position the slide interlock engages in the LOGO! Base Module.

#### LOGO! 0BA7

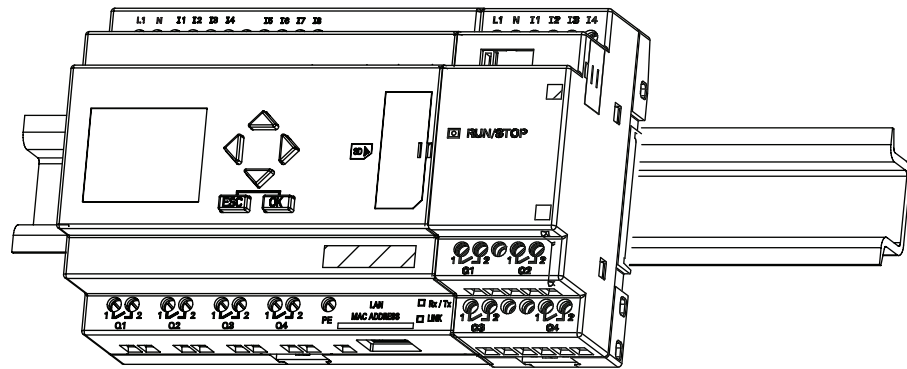

#### LOGO! 0BA6

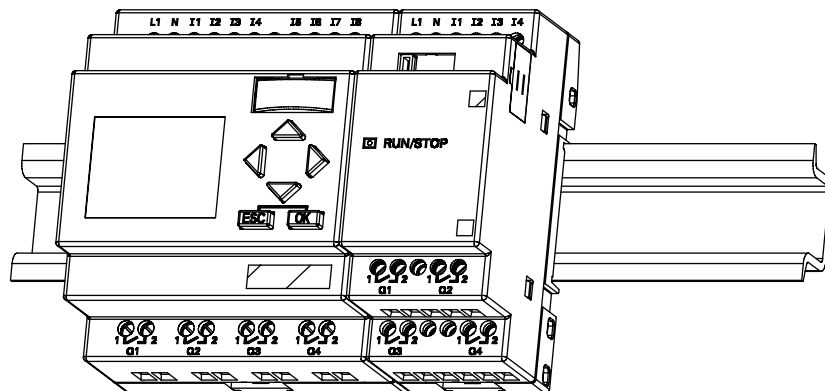

Repeat the digital module steps to mount further expansion modules.

#### Note

The expansion interface on the last expansion module must be covered.

### Removal

To **remove** LOGO!:

..... if you have installed **only one** LOGO! **Base Module**:

1. Insert a screwdriver into the eyelet at the bottom of the slide interlock and move the latch downward.
2. Swing the LOGO! Base Module off the DIN rail.

LOGO! 0BA7

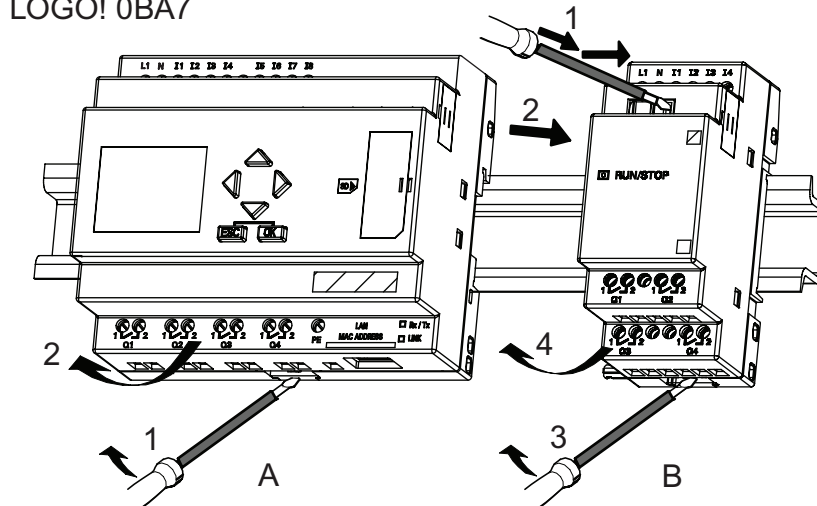

LOGO! 0BA6

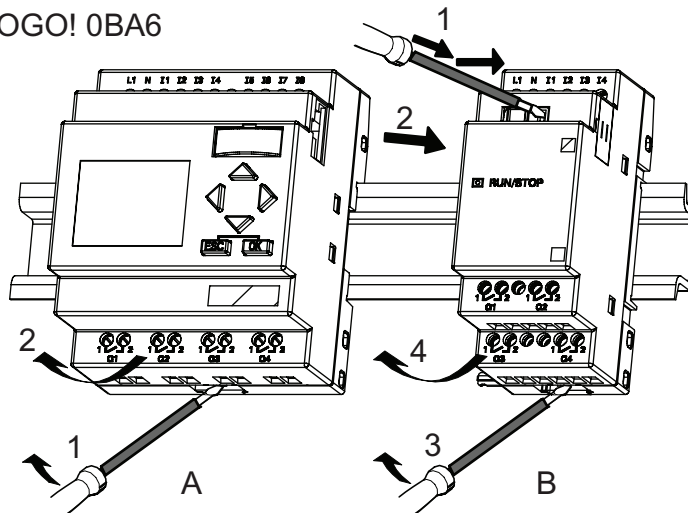

..... if you have connected **at least one expansion module** to the LOGO! Base Module:

1. Using a screwdriver, push the integrated slide interlock to the right.
2. Slide the expansion module off towards the right.
3. Insert a screwdriver into the eyelet at the bottom of the slide interlock and lever it downward.
4. Swing the expansion module off the profile rail.

Repeat steps 1 to 4 for all other expansion modules.

---

**Note**

If you have connected more than one expansion module, it is advisable to start removal with the last module at the right-hand side.

Make sure the slide interlock of the module to be installed/removed is not engaged in the next module.

---

## 2.2.2 Wall-mounting

For wall-mounting, first slide the mounting slides on the rear side of the devices towards the **outside**. You can now wall-mount LOGO! by means of two mounting slides and two Ø M4 screws (tightening torque 0.8 to 1.2 Nm).

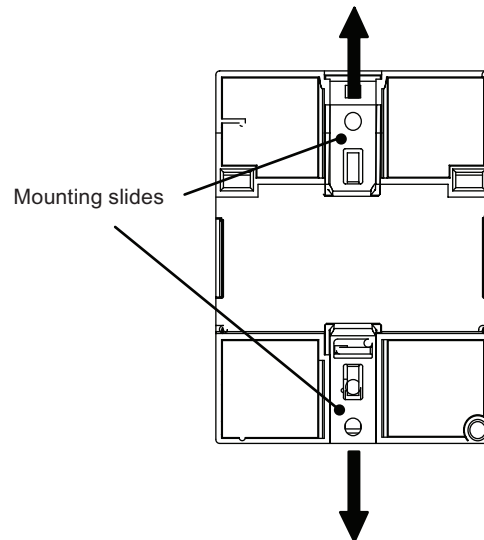





### 2.2.3 Mounting the LOGO! TD

To prepare the mounting surface for the optional LOGO! TD and mount it, follow these steps:

1. Cut a 119.5 mm x 78.5 mm (tolerance: +0.5 mm) hole in the mounting surface.

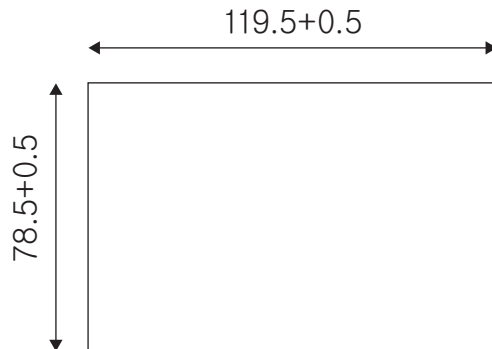

2. Place the included gasket on the frontplate of the LOGO! TD.
3. Fit the LOGO! TD into the cutout you made in the mounting surface.
4. Attach the mounting brackets (included) to the LOGO! TD.
5. Tighten the mounting screws on the mounting brackets to 0.2 Nm torque to secure the LOGO! TD.

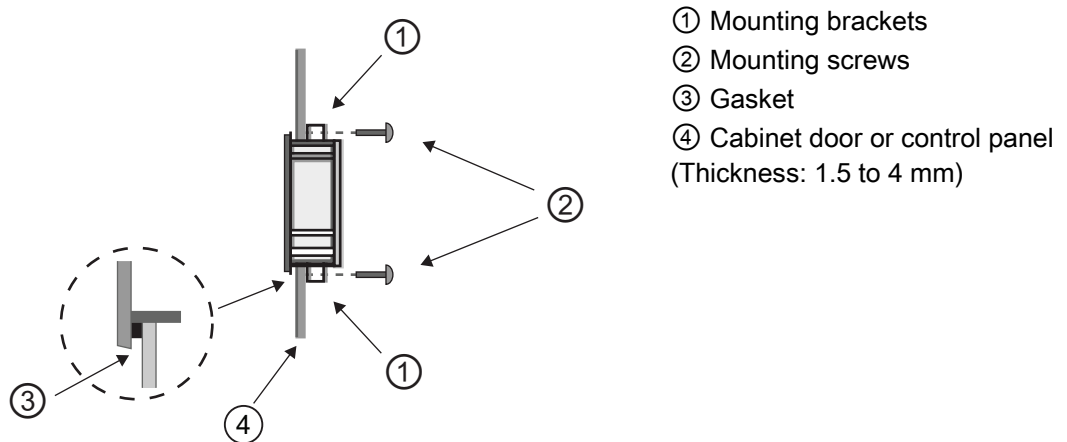

You can then use the included cable to connect the LOGO! TD to the LOGO! Base Module up to a distance of 2.5 meters. You can extend this distance to up to ten meters by using a standard Sub-D cable together with the LOGO! TD cable.

### 2.2.4 Labeling LOGO!

The gray rectangular areas on the LOGO! modules are intended for labeling.

In the case of expansion modules, you can use the gray areas for labeling the inputs and outputs, for example. In this connection, you can enter a delta factor of +8 for the inputs or +4 for the outputs if the LOGO! Base Module already has 8 inputs or 4 outputs.

## 2.3 Wiring LOGO!

Wire LOGO! using a screwdriver with a 3-mm blade.

You do not need wire ferrules for the terminals. You can use conductors with cross-sections of up to the following thicknesses:

- 1 x 2.5 mm<sup>2</sup>
- 2 x 1.5 mm<sup>2</sup> for each second terminal chamber

Tightening torque: 0.4...0.5 Nm or 3...4 in-lbs.

---

### Note

Always cover the terminals after you have completed the installation. To protect LOGO! adequately from impermissible contact to live parts, comply with local standards.

---

### 2.3.1 Connecting the power supply

The 230-V versions of LOGO! are suitable for operation with rated voltages of 115 V AC/DC and 240 V AC/DC. The LOGO! 24-V and 12-V versions can be operated with a 24 VDC, 24 V AC or 12 V DC power supply. For information on permissible voltage tolerances, line frequencies and power consumption, refer to the installation instructions in the Product Information supplied with your device and to the technical data in Appendix A.

The CM EIB/KNX has been designed as a communication module for the LOGO! controller and must be supplied with a mains voltage of 24 V AC/DC.

The AS Interface bus requires a special AS Interface power supply (30 V DC) that enables simultaneous transmission of data and power for the encoders via a single line.

The LOGO! TD must be supplied with a voltage of 12 V DC or 24 V AC/DC.

 <b>CAUTION</b>
--

Expansion modules DM8 230R and DM16 230R must be operated with the same type of power supply (DC or AC) as for the connected 230-V version of the LOGO! Base Module. The same supply output "+/- " on DC power supplies or "N/L" on AC power supplies must connect to the same phase on both the expansion module DM8/16 230R and the connected LOGO! 230 .... Failure to follow the instructions could result in personal injury.
--

---

### Note

A power failure might cause an additional edge triggering signal at the special functions. The stored data will be from the last uninterrupted cycle.

---

## Connecting LOGO!

To connect LOGO! to the power supply:

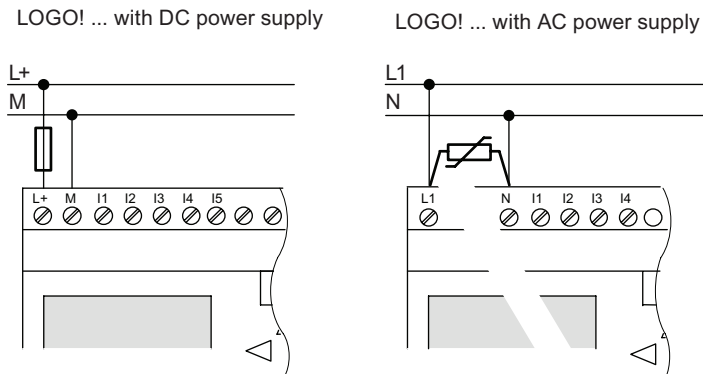

Protection with safety fuse  
if required (recommended) for:

12/24 RC...:	0.8 A
24:	2.0 A
EIB/KNX	0.08 A

To suppress surge voltages, install  
varistors (MOV) with an operating  
voltage at least 20 % above the rated  
voltage.

---

### Note

LOGO! is a double-insulated switchgear. For LOGO! 0BA6, you do not need to connect an equipment grounding conductor. For LOGO! 0BA7, however, you must connect its PE terminal to earth ground.

---

## Circuit protection with AC voltage

To suppress voltage peaks on the power supply lines, you can install a metal oxide varistor (MOV). Make sure the operating voltage of the varistor (MOV) used lies at least 20 % above the rated voltage (for example S10K275).

## Circuit protection with DC voltage

To suppress voltage peaks on the power supply lines, please install a protection device. DEHN (order number: 918 402) is recommended.

### 2.3.2 Connecting the LOGO! TD power supply

The LOGO! TD must be connected to an external power supply that supplies a voltage of 12 V DC or 24 V AC/DC. A power connector is included with the LOGO! TD.

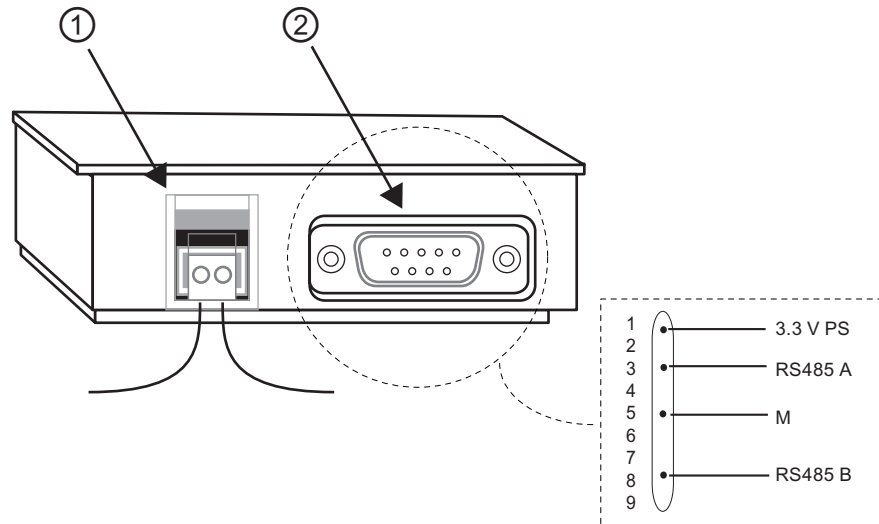

- ① Power supply
- ② Communication interface

The power connection is non-polar. If you connect a DC power supply to the LOGO! TD, you can connect the positive supply wire or negative supply wire to either the left or right side.

#### Note

Siemens recommends that you protect the LOGO! TD with a 0.5 A safety fuse on the power supply.

### 2.3.3 Connecting LOGO! inputs

#### Requirements

At the inputs you connect sensor elements such as: momentary pushbuttons, switches, light barriers, daylight control switches etc.

#### Sensor characteristics for LOGO!

	LOGO! 12/24RCE LOGO! 12/24RC LOGO! 12/24RCo		LOGO! 24/24o LOGO! 24C/24Co		LOGO! DM8 12/24R	LOGO! DM8 24
	I3 ... I6	I1,I2,I7,I8	I3 ... I6	I1,I2,I7,I8	I1 ... I8	I1 ... I8
<b>Signal status 0</b> Input current	< 5 V DC < 0.85 mA	< 5 V DC < 0.05 mA	< 5 V DC < 0.85 mA	< 5 V DC < 0.05 mA	< 5 V DC < 0.85 mA	< 5 V DC < 0.85 mA
<b>Signal status 1</b> Input current	> 8.5 V DC > 1.5 mA	> 8.5 V DC > 0.1 mA	> 12 V DC > 2 mA	> 12 V DC > 0.15 mA	> 8.5 V DC > 1.5 mA	> 12 V DC > 2 mA

	LOGO! 24RC (AC) LOGO! 24RCo (AC) LOGO! DM8 24R (AC)	LOGO! 24RC (DC) LOGO! 24RCo (DC) LOGO! DM8 24R (DC)	LOGO! 230RCE (AC) LOGO! 230RC (AC) LOGO! 230RCo (AC) LOGO! DM8 230R (AC)	LOGO!230RCE (DC) LOGO! 230RC (DC) LOGO! 230RCo (DC) LOGO! DM8 230R (DC)
<b>Signal status 0</b> Input current	< 5 V AC < 1.0 mA	< 5 V DC < 1.0 mA	< 40 V AC < 0.03 mA	< 30 V DC < 0.03 mA
<b>Signal status 1</b> Input current	> 12 V AC > 2.5 mA	> 12 V DC > 2.5 mA	> 79 V AC > 0.08 mA	> 79 V DC > 0.08 mA

	LOGO! DM16 24R	LOGO! DM16 24	LOGO! DM16 230R (AC)	LOGO! DM16 230R (DC)
<b>Signal status 0</b> Input current	< 5 V DC < 1.0 mA	< 5 V DC < 1.0 mA	< 40 V AC < 0.05 mA	< 30 V DC < 0.05 mA
<b>Signal status 1</b> Input current	> 12 V DC > 2.0 mA	> 12 V DC > 2.0 mA	> 79 V AC > 0.08 mA	> 79 V DC > 0.08 mA

#### Note

The digital inputs of LOGO! 230RCE/230RC/230RCo and of expansion module DM16 230R are divided into two groups, each consisting of four inputs. **Within** the same group, all inputs must be operated on the **same** phase. **Different** phases are only possible **between** the groups.

Example: I1 to I4 on phase **L1**, I5 to I8 on phase **L2**.

The inputs of the LOGO! DM8 230R must **not** be connected to different phases.

### Sensor connections

#### Connecting glow lamps and 2-wire proximity switches (Bero) to LOGO! 230RCE/230RC/230RCo or LOGO! DM8 230R (AC) and LOGO! DM16 230R (AC)

The figure below shows how you connect a switch with a glow lamp to LOGO!. The current that flows through the glow lamp allows LOGO! to detect a "1" signal even though the switch contact is not closed. If, however, you use a switch the glow lamp of which is fitted with a power supply, this response does not occur.

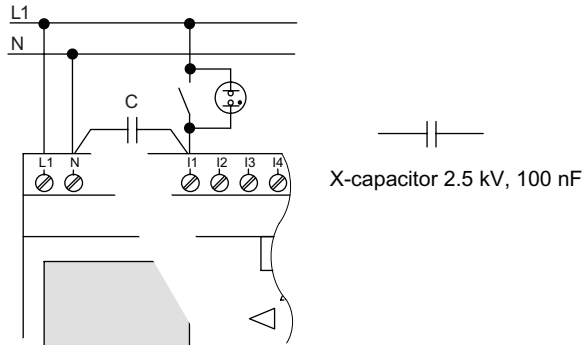

Take into account the quiescent current of any 2-wire proximity switches used. The level of the quiescent current of some 2-wire proximity switches is high enough to trigger a logical "1" signal at the LOGO! input. You should therefore compare the quiescent current of the proximity switches with the technical data of inputs (Page 319).

#### Remedy

To suppress this response, use an X capacitor rated at 100 nF and 2.5 kV. In a destructive situation, this type of capacitor safely disconnects. You must choose the voltage level for which the capacitor is rated such that it is not destroyed in the case of overvoltage!

At 230 V AC, the voltage between N and an input I(n) must not be greater than 40 V to guarantee a "0" signal. You can connect approximately ten glow lamps to the capacitor.

### Restrictions

#### Signal status transitions 0 → 1 / 1 → 0:

After a 0 to 1 or 1 to 0 transition, the signal must remain constant at the input at least for the duration of one program cycle, so that LOGO! can detect the new signal status.

The program execution time is determined by the size of the circuit program. The appendix "Determining the cycle time (Page 349)" contains a benchmark test routine that you can use to determine the current scan cycle time.

## Special features of LOGO! 12/24RCE/RC/RCo, LOGO! 24/24o and LOGO! 24C/24Co

### *Fast digital inputs: I3, I4, I5 and I6:*

These versions are also equipped with fast digital inputs (up/down counters, threshold triggers). The restrictions mentioned earlier do not apply to these fast digital inputs.

---

### **Note**

The fast digital inputs I3, I4, I5 and I6 are the same as in the previous versions 0BA0 to 0BA5; therefore, a circuit program that is written in these versions can be transferred to the 0BA6 or 0BA7 devices with the programming software LOGO!Soft Comfort, without any changes to these features. In contrast to this, you need to modify circuit programs written for a LOGO!...L version (fast digital inputs I11-I12). The fast digital inputs have increased from 2 kHz to 5 kHz with the 0BA6 series.

Expansion modules do not have fast digital inputs.

---

### *Analog inputs: I1 and I2, I7 and I8:*

The inputs I1, I2, I7 and I8 of LOGO! versions 12/24RCE/RC/RCo, 24/24o and 24C/24Co can be used as either digital inputs or analog inputs. The input mode is defined in the LOGO! circuit program.

The inputs I1, I2, I7 and I8 provide digital inputs, and the inputs AI3, AI4, AI1 and AI2 provide analog inputs, as described in the topic "Constants and connectors - Co (Page 138)". AI3 corresponds to the input terminal I1; AI4 corresponds to I2; AI1 corresponds to I7; AI2 corresponds to I8. The use of AI3 and AI4 is optional. You configure your LOGO! to use either two or four analog inputs as described in topic "Setting the number of AIs in the LOGO! Basic (Page 299)" in Section 5.2.4.

When using inputs I1, I2, I7 and I8 as analog inputs, only the range from 0 to 10 V DC is available.

### **Connecting a potentiometer to inputs I1, I2, I7 and I8**

To allow you to achieve 10 V as the maximum value when you completely turn the potentiometer once, you must connect a series resistor on the potentiometer's input side regardless of the input voltage (see figure below).

We suggest the following sizes of potentiometers and associated series resistors:

Voltage	Potentiometer	Series Resistor
12 V	5 k $\Omega$	-
24 V	5 k $\Omega$	6.6 k $\Omega$

When using a potentiometer and 10 V input voltage as the maximum value, you must ensure that with a connected input voltage of 24 V, 14 V must release via the series resistor so that a maximum of 10 V are supplied when you turn the potentiometer one full rotation. With a voltage of 12 V, this can be neglected.

---

### **Note**

The LOGO! AM2 expansion module provides additional analog inputs. The LOGO! AM2 PT100 expansion module provides PT100 inputs.

Always use twisted and shielded cables for analog signals, and keep these as short as possible.

---

**Sensor connections**

To connect sensors to LOGO! :

**LOGO! 12/24.... and LOGO! 24...**

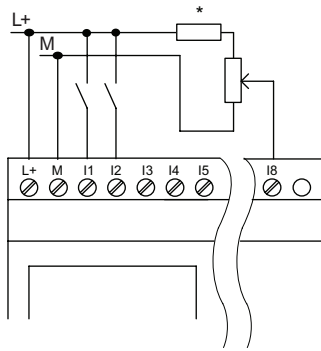

The inputs of these devices are not isolated and therefore require a common reference potential (chassis ground).

With LOGO! 12/24RCE/RC/RCo, LOGO! 24/24o and LOGO! 24C/24Co modules, you can tap analog signals between the supply voltage and chassis ground (\* = series resistor (6.6 kΩ) at 24 V DC).

**LOGO! 230....**

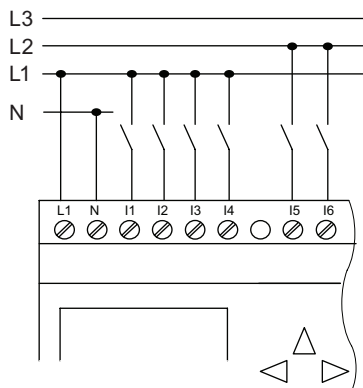

The inputs of these devices are arranged in two groups, each consisting of four inputs. Different phases are only possible between blocks, but not within the blocks.

 <b>WARNING</b>
Current safety regulations (VDE 0110, ... and IEC 61131-2, ... as well as cULus) do not permit the connection of different phases to an AC input group (I1 to I4 or I5 to I8) or to the inputs of a digital module.



## LOGO! AM2

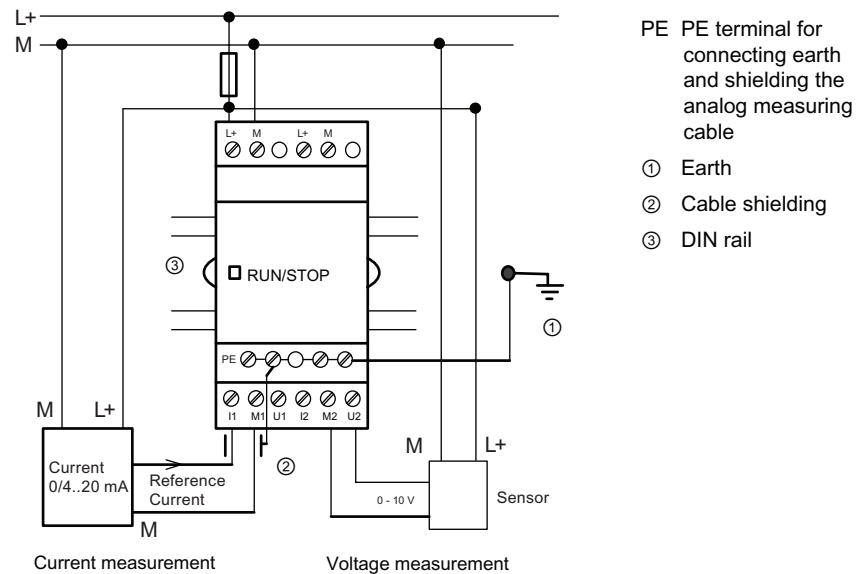

The illustration above shows an example of four-wire current measurement and two-wire voltage measurement.

### Connecting a two-wire sensor to the LOGO! AM2

Wire up the two-wire sensor's connecting wires as follows:

1. Connect the sensor's output to connection U (0 ... 10 V voltage measurement) or to connection I (0/4 ... 20 mA current measurement) of the AM2 module.
2. Connect the plus connector on the sensor to the 24 V supply voltage (L+).
3. Connect the ground connection of the current output M (on the right side of the sensor, as shown in the figure above) to the corresponding M input (M1 or M2) on the AM2 module.

### LOGO! AM2 PT100

You can connect a maximum of two 2-wire or 3-wire PT100 sensors or one 2-wire plus one 3-wire PT100 sensor to the module. Note that the sensor type supported by the module is only PT100 with the default temperature coefficient of  $\alpha = 0.003850$ .

For a **2-wire** connection, you need to short-circuit terminals M1+ and IC1 or M2+ and IC2. Errors caused by the ohmic resistance of the measuring line are not compensated for this type of connection. A line resistance of  $1 \Omega$  is proportional to measuring error of  $+2.5 \text{ }^\circ\text{C}$ .

A **3-wire** technique suppresses the influence of the cable length (ohmic resistance) on the result of the measurement.

2-wire technique

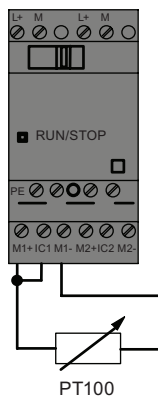

3-wire technique

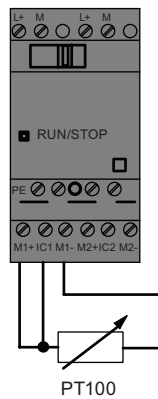

## LOGO! AM2 RTD

You can connect a maximum of two PT100 sensors or two PT1000 or one PT100 plus one PT1000 sensor in a 2-wire or 3-wire connection or in a mixed use of 2-wire and 3-wire connection to the module. Note that the sensor type supported by the module is only PT100 or PT1000 with the default temperature coefficient of  $\alpha = 0.003850$ .

For a **2-wire** connection, you need to short-circuit terminals M1+ and IC1 or M2+ and IC2. Errors caused by the ohmic resistance of the measuring line are not compensated for this type of connection. If a PT100 sensor is connected, a line resistance of  $1 \Omega$  is proportional to measuring error of  $+2.5 \text{ }^\circ\text{C}$ ; if a PT1000 sensor is connected, a line resistance of  $1 \Omega$  is proportional to measuring error of  $+0.25 \text{ }^\circ\text{C}$ .

A **3-wire** technique suppresses the influence of the cable length (ohmic resistance) on the result of the measurement.

### 2-wire technique

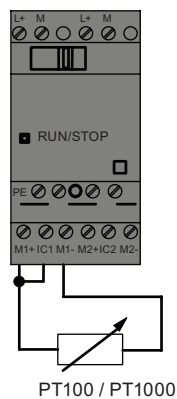

### 3-wire technique

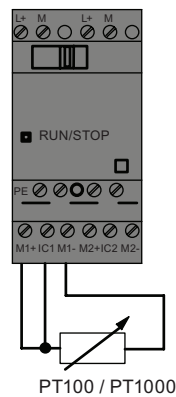

## Note

Fluctuating analog values are due to screening on the connecting wire from the analog valuator device to the analog AM2 / AM2 PT100 / AM2 RTD LOGO! expansion module (encoder wire) that has either been mounted incorrectly or not at all.

To avoid fluctuating analog values when using these expansion modules, proceed as follows:

- Use only shielded encoder wires.
- Shorten the encoder wire as much as possible. The encoder wire must not be more than 10 meters long.
- Clamp the encoder wire on one side only and clamp it only to the PE terminal on the AM2 / AM2 PT100 / AM2 AQ / AM2 RTD expansion module.
- Connect ground on the encoder supply to the PE terminal on the expansion module.
- Avoid operating the LOGO! AM2 PT100 or LOGO! AM2 RTD expansion module with a power supply that is not grounded (potential-free). If you cannot avoid this, connect the negative output/ground output on the power supply to the shielding on the resistance thermometer's measuring wires.

### 2.3.4 Connecting outputs

#### LOGO! ...R...

The LOGO! ...R... version is equipped with relay outputs. The potential of the relay contacts is isolated from the power supply and the inputs.

#### Requirements for relay outputs

You can connect various loads to the outputs; e.g., lamps, fluorescent lamps, motors, contactor relays, etc. For information on the properties required for the loads connected to LOGO! ...R..., refer to the technical data (Page 319).

#### Connecting

This is how you connect the load to LOGO! ...R... :

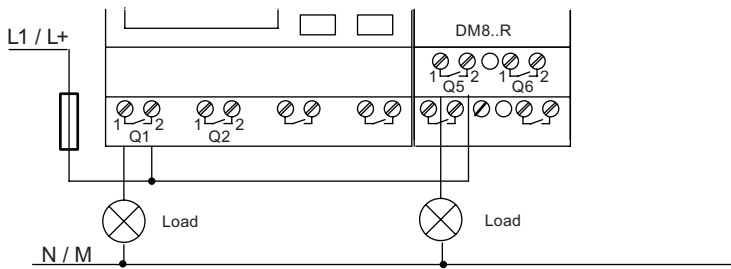

Protection with automatic circuit-breaker, max. 16 A, characteristics B16, e. g. : Power circuit-breaker 5SX2 116-6 (if required)

#### LOGO! with solid-state outputs

LOGO! versions with solid-state outputs can be identified by the fact that the letter **R** is missing from their type name. The outputs are short circuit-proof and overload-proof. An auxiliary load voltage supply is not necessary, because LOGO! supplies the load voltage.

#### Requirements for solid-state outputs

The load connected to LOGO! must have the following characteristics:

- The maximum switched current is 0.3 A per output.

## Connecting

This is how you connect the load to a LOGO! with solid-state outputs:

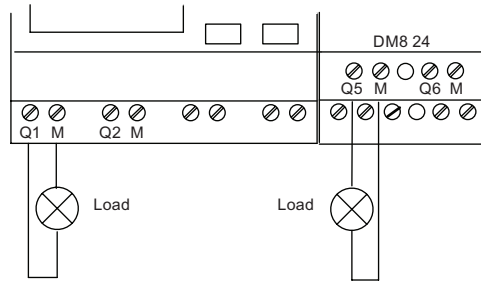

Load: 24 V DC, 0.3 A max.

## LOGO! AM2 AQ

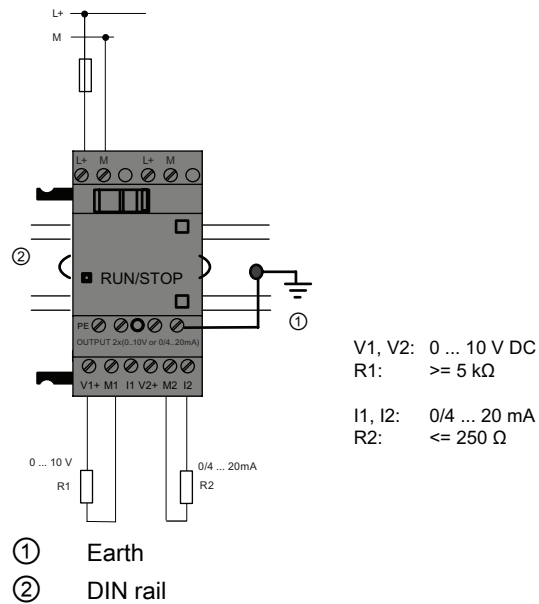

The illustration above shows an example of how to connect the voltage or current load.

### 2.3.5 Connecting the EIB bus

The connection is carried out via the two-pole screw terminal (+ and -).

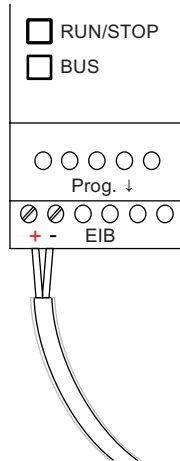

Only the red-black core pair is used, the white-yellow core pair is not connected.

Press the button "Prog ↓" to switch the CM EIB/KNX to programming mode.

---

#### Note

The button "Prog ↓" should not be pressed too firmly.

If the bus connection is OK, the LED lights up green.

In programming mode, the LED lights up orange.

---

### Networking on the EIB bus

The CM EIB/KNX takes over the communication between LOGO! and *EIB* and makes communication available via *EIB* inputs/outputs.

The application of the CM EIB/KNX fills the complete LOGO! process image; that is, inputs or outputs which are not occupied on LOGO! can be occupied on the EIB.

---

#### Note

For detailed information about the networking of LOGO! on the *EIB* bus please refer to the LOGO! CM EIB/KNX documentation, in particular the Micro Automation Set 8.

---

## 2.3.6 Connecting the AS interface bus

To set the address of the module on the AS interface bus, you need an addressing unit. Valid addresses are in the range of 1 to 31. Use each address once only.

You can set the address on the AS interface bus before or after installation. If the installed module is addressed via the address socket, the AS-Interface voltage must be disconnected beforehand. This is necessary for safety reasons.

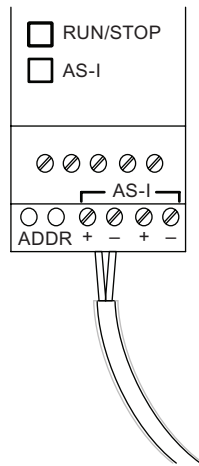

### Networking on the AS interface bus

To make the connection to the AS interface bus, you need a communications-capable LOGO! variant:

- LOGO! Base Module + CM AS-I.

To be able to send data across the AS interface bus to LOGO! and to receive data from it in the same way, you also need:

- an AS interface power supply and
- an AS interface master (e.g. an S7-200 with a CP243-2 or a DP/AS-I Link 20 E).

LOGO! can only be accepted as a slave on the AS interface bus. This means that it is not possible to directly exchange data between two LOGO! devices. Data is always exchanged across the AS interface master.

#### WARNING

The AS-Interface and LOGO! systems must **never** be connected together electrically!  
Use safe isolation according to IEC 61131-2, EN 50178, UL 508, CSA C22.2 No. 42.

**Logic Assignments**

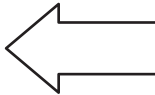
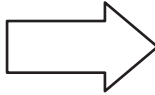
LOGO! system		AS Interface system
<b>Inputs</b>		<b>Output data bits</b>
I <sub>n</sub>		DQ1
I <sub>n+1</sub>		DQ2
I <sub>n+2</sub>		DQ3
I <sub>n+3</sub>		DQ4
<b>Outputs</b>		<b>Input data bits</b>
Q <sub>n</sub>		DI1
Q <sub>n+1</sub>		DI2
Q <sub>n+2</sub>		DI3
Q <sub>n+3</sub>		DI4

"n" depends on the plug-in position of the expansion module relative to the LOGO! Base Module. It indicates the number of the input or output in LOGO! program code.

**Note**

Ensure that there is enough space for the inputs/outputs of the AS interface in the LOGO!'s address space. If you are already using more than 12 physical outputs or more than 20 physical inputs, it is no longer possible to operate the CM AS interface!

For detailed information about the networking of LOGO! on the AS interface bus please refer to the LOGO! CM AS Interface documentation, in particular the Micro Automation Sets 7 and 16.



### 2.3.7 Connecting modems (0BA6 only)

The LOGO! 0BA6 device series supports a modem connection between a PC and LOGO! 0BA6 Base Module. You can use modems to download and upload circuit programs between LOGO!Soft Comfort and LOGO! devices. Configuration of the modem connection is only possible with LOGO!Soft Comfort V6.1 or later.

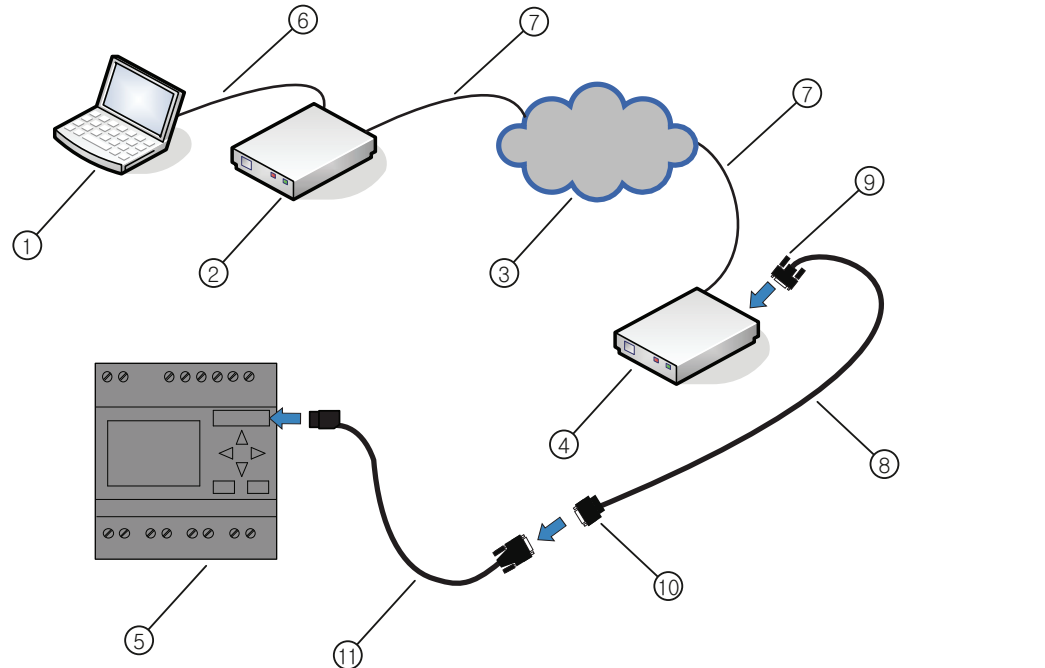

- |   |  |   |  |
|---|--|---|--|
| ① | PC (desktop or laptop)                   | ⑦ | Standard RJ11 telephone line                                   |
| ② | Local modem (Recommended: INSYS Modem)   | ⑧ | LOGO! modem cable (length: 0.5 m)                              |
| ③ | PSTN (Public Switched Telephone Network) | ⑨ | Cable connector, with the visible text "MODEM" on each side    |
| ④ | Remote modem (Recommended: INSYS Modem)  | ⑩ | Cable connector, with the visible text "PC CABLE" on each side |
| ⑤ | LOGO! Base Module                        | ⑪ | LOGO! PC cable   |
| ⑥ | Standard RS232 cable (9-pin)             |   |  |

For the detailed description of modem configuration, see the LOGO!Soft Comfort V7.0 online help.

For the detailed description of the LOGO! modem cable, see the Product Information supplied with your LOGO! modem cable.

#### NOTICE

The modems used must fulfill the following requirements:

Ability to transmit 11-bit bytes (8 data bits, 1 stop bit, 1 even parity bit)

Ability to supply standard AT commands or commands that function as standard AT commands

The modem connected with the LOGO! modem cable must be able to supply at least 5 mA current through Pin 1 of its RS232 interface.

### 2.3.8 Connecting the Ethernet interface (OBA7 only)

#### LOGO! ...E

The LOGO! ...E version is equipped with a 10/100 Mbit/s Ethernet RJ45 interface.

#### Requirements for the network cable

You can connect a standard Ethernet cable to the Ethernet interface. To minimize electromagnetic interference, however, Siemens recommends you use a standard Category 5 shielded twisted-pair Ethernet cable with a shielded RJ45 connector on each end.

#### Connecting

You connect the PE terminal to earth ground, and connect a network cable to the Ethernet interface.

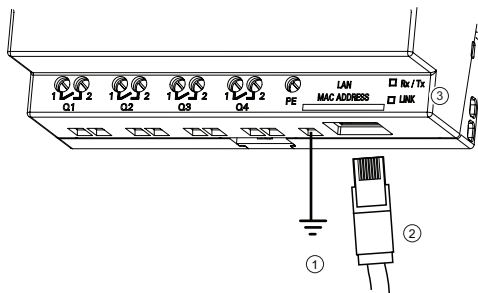

- ① Earth ground
- ② Ethernet cable, for connecting to the Ethernet interface
- ③ Ethernet status LEDs

#### Ethernet status LEDs

LED	Color	Description
Rx/Tx	Flashing orange	LOGO! is receiving/sending data across Ethernet
LINK	Steady green	LOGO! is already connected to Ethernet

## **2.4 Putting into operation**

### **2.4.1 Switching the LOGO!/Power On**

LOGO! does not have a power switch. The reaction of LOGO! during startup depends on the following:

- Whether a circuit program is stored in LOGO!
- Whether a card is inserted (The card can be a LOGO! memory card, combined memory/battery card, or SD card for a LOGO! 0BA7.)
- Whether this is a LOGO! version without display unit (LOGO!...o)
- The status of LOGO! at the time of power failure.

To ensure that the expansion module on LOGO! changes to RUN mode, check the following:

- Has the sliding contact between LOGO! and the expansion module snapped into place properly?
- Is the power supply connected to the expansion module?
- In addition, always ensure that you switch on the power supply to the expansion module first before activating the power supply to the LOGO! Base Module (or activate both power supplies at the same time); if you do not do this, the system does not detect the expansion module when you start up the LOGO! Base Module.

The following illustration shows all possible reactions of LOGO!:

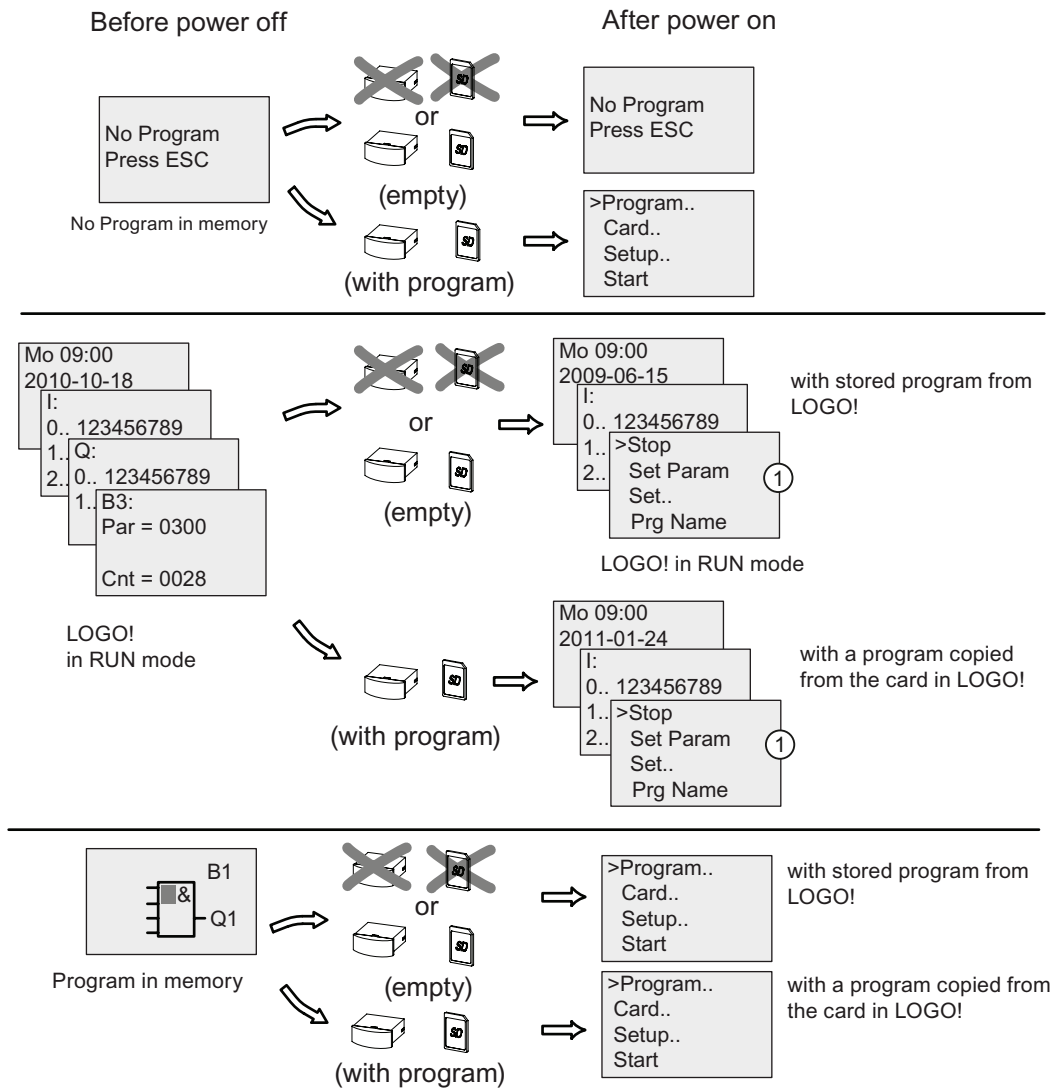

① This power-on screen is only available on LOGO! 0BA7.

You can also memorize four simple rules for starting LOGO! :

1. If neither LOGO! nor the inserted card contains a circuit program, the LOGO! Basic displays the following:

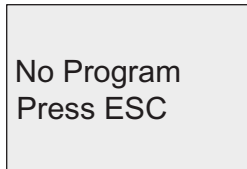

2. A circuit program on the card is automatically copied to LOGO!. The circuit program in LOGO! is overwritten.
3. If there is a circuit program in LOGO! or on the card, LOGO! adopts the operational state it had prior to POWER-OFF. Versions without a display unit (LOGO!...o) automatically change from STOP to RUN (LED changes from red to green).
4. If you have enabled retentivity for at least one function, or a function is permanently retentive, the current values are retained at POWER-OFF.

---

**Note**

When a power failure occurs while you are entering a circuit program, the program in LOGO! is deleted after power is returned.

Before you modify the circuit program, save a backup copy of your original to a card or to a computer, using LOGO!Soft Comfort.

---

### 2.4.2 Putting a CM EIB/KNX into operation

1. Bus voltage and supply voltage must be present.
2. Connect the PC to the serial EIB interface.
3. Start software ETS, using ETS2 version 1.2.
4. Configure the application program in ETS2, V 1.2.
5. The application program is loaded into the devices via the EIB interface. The application program is available on the LOGO! home page (<http://www.siemens.de/logo>).
6. Click on "Program Physical Address" in ETS.
7. Press the button of the CM EIB/KNX to switch the CM EIB/KNX to programming mode; LED lights up orange.

---

#### Note

The button "Prog ↓ " should not be pressed too firmly.

If the bus connection is OK, the LED lights up green.

In programming mode, the LED lights up orange.

---

8. If the LED is extinguished, the programming of the physical address has finished. You can now mark the physical address on the device. Composition of the physical address:  
Area / Line / Device XX / XX / XXX
9. The application program can now be run. The device is then ready for operation.
10. If several CM EIB/KNX are installed in an EIB system, steps 1 to 9 must be repeated for each CM EIB/KNX.
11. Any further details about EIB commissioning can be found in the corresponding documentation.

### 2.4.3 Operating states

#### LOGO! Base Module operating states

LOGO! Base Modules (LOGO! Basic or LOGO! Pure) have two operating states: STOP and RUN.

STOP	RUN
<ul style="list-style-type: none"> <li>• The display shows: 'No Program' (not LOGO!...o)</li> <li>• Switching LOGO! to programming mode (not LOGO!...o)</li> <li>• LED is red (only LOGO!...o)</li> </ul>	<ul style="list-style-type: none"> <li>• Display: Screen mask for monitoring I/O and messages (after START in the main menu) (not LOGO!...o or LOGO!...E)</li> <li>• Display: Screen mask for monitoring I/O and messages (after START in the main menu) or for the parameter assignment menu (only LOGO!...E)</li> <li>• Switching LOGO! to parameter assignment mode (not LOGO!...o or LOGO!...E)</li> <li>• LED is green (only LOGO!...o)</li> </ul>
<p>Action of LOGO!:</p> <ul style="list-style-type: none"> <li>• The input data is not read.</li> <li>• The circuit program is not executed.</li> <li>• The relay contacts are permanently open or the solid-state outputs are switched off.</li> </ul>	<p>Action of LOGO!:</p> <ul style="list-style-type: none"> <li>• LOGO! reads the status of the inputs.</li> <li>• LOGO! uses the circuit program to calculate the status of the outputs.</li> <li>• LOGO! switches the relay/solid-state outputs on or off.</li> </ul>

#### Note

After switching the power on, the system briefly switches through the outputs on the LOGO 24/24o or LOGO! 24C/24Co. With an open circuit, a voltage of > 8 V can occur for up to approximately 100 ms; when loaded, this time reduces to a matter of microseconds.

#### LOGO! expansion modules, operating states

LOGO! expansion modules have three operating states: The LED (RUN/STOP) is lit green, red or orange.

LED (RUN/STOP) is lit		
Green (RUN)	Red (STOP)	Orange/Yellow
The expansion module communicates with the device to the left.	The expansion module does <b>not</b> communicate with the device to its left.	Initialization phase of the expansion module

**CM AS Interface, communication states**

The CM AS Interface has three communication states: The LED is lit green, red or flashes red/yellow.

LED AS-I is lit		
Green	Red	Red/Yellow
AS Interface communication OK	AS Interface communication failed	Slave has address "0".

**CM AS Interface, behavior on communication failure**

- If the AS Interface voltage fails, communication between the LOGO! system and the expansion modules, which are arranged to the right of the LOGO! CM AS Interface expansion module, is interrupted.  
Recommendation: Position LOGO! CM AS Interface on the far right side.
- If communication is interrupted, the switching outputs are reset after about 40 to 100 ms.

**CM EIB/KNX, communication states**

The CM EIB/KNX has three communication states: The LED is lit green, red or orange.

LED BUS is lit		
Green	Red	Orange
Bus connection OK, communication OK, no programming mode	Bus connection interrupted	Programming mode active and bus connection OK

**CM EIB/KNX, behavior on communication failure**

- LOGO! voltage failure  
If there is a power failure of LOGO! or a disruption in the communication to the LOGO! master or to the communication partner on the left side, the outputs are set to 0. The RUN/STOP LED lights up red after a second.
- LOGO! voltage recovery  
LOGO! starts up again, CM EIB/KNX sends the parameterized states.
- CM EIB/KNX voltage failure  
All the inputs of the LOGO! master on the *EIB* are set to 0 by the LOGO! master.
- CM EIB/KNX voltage recovery  
All the outputs of the LOGO! master on the *EIB* are updated. The inputs are read by the *EIB* depending on the parameterization.
- Short circuit on the bus or bus interruption  
The behavior can be parameterized in the LOGO! configuration window of the application program in ETS (EIB Tool Software). The red light is set after 5 seconds.
- Bus recovery  
The behavior can be parameterized in the LOGO! configuration window.



# Programming LOGO!

## Getting started with LOGO!

Programming refers to creating a circuit program from the LOGO! Base Module.

In this chapter you will learn how to use LOGO! to create the LOGO! circuit programs for your application.

LOGO!Soft Comfort is the LOGO! programming software that you can use on your PC to quickly and easily create, test, modify, save and print the circuit programs. The topics in this manual, however, relate only to the creation of circuit programs on the actual LOGO! Base Module. The programming software LOGO! Soft Comfort contains extensive online help.

---

### Note

LOGO! versions without a display unit, that is, the LOGO! 24o, LOGO! 24Co, LOGO! 12/24RCo, LOGO! 24RCo and LOGO! 230RCo versions, do not have an operator panel and display unit. They are primarily designed for use in small machine and process equipment engineering systems for series production.

LOGO!...o versions are not programmed directly on the device. Instead, the circuit program is downloaded to the device from LOGO!Soft Comfort or from memory cards or combined memory/battery cards from other LOGO! devices.

LOGO! versions without a display cannot write data to memory cards or combined memory/battery cards.

See the chapters "Applicable cards (Page 303)", "LOGO! software (Page 313)" and the appendix "LOGO! without display ("LOGO! Pure") (Page 351)" for more information.

---

A small example in the first part of this chapter introduces the operating principles of LOGO!:

- You will learn the meaning of two basic terms, namely the **connector** and the **block**.
- As the next step, you will create a circuit program based on a simple conventional circuit.
- Lastly, you will enter this program directly in LOGO!

It will take you only a few pages of this manual to store your first executable circuit program in the LOGO! unit. With suitable hardware (switches etc.), you will then be able to carry out initial tests.

### 3.1 Connectors

LOGO! is equipped with inputs and outputs

Example of a configuration with several modules:

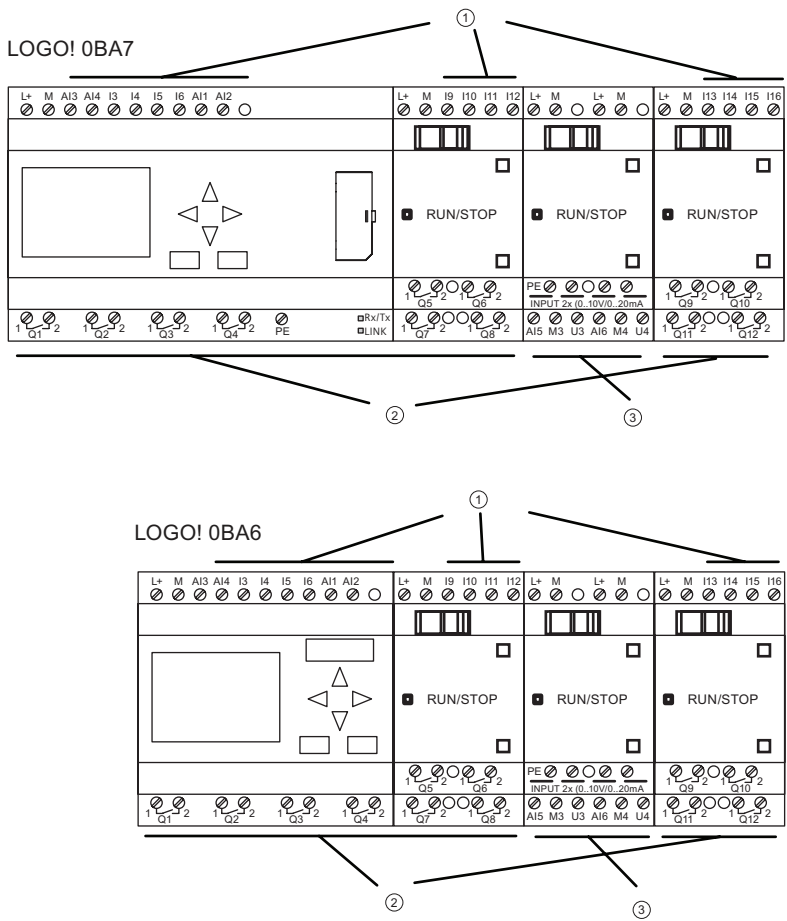

- ① Inputs
- ② Outputs
- ③ Analog inputs

Each input is identified by the letter I plus a number. When you look at LOGO! from the front, you can see the input terminals at the top. Only analog input modules LOGO! AM2, AM2 PT100 and AM2 RTD have the inputs at the bottom.

Each output is identified by the letter Q plus a number (AM2 AQ: AQ plus number). In the figure, you can see the output terminals at the bottom.

**Note**

LOGO! can recognize, read and switch the I/O of all expansion modules regardless of their type. The I/O are presented in the installation order of the modules.

Dependent upon specific LOGO! device series, the following I/O and flag blocks are available for creating your circuit program from LOGO!:

- LOGO! 0BA6

I1 to I24, AI1 to AI8, Q1 to Q16, AQ1 and AQ2, M1 to M27, and AM1 to AM6. Also available are the shift register bits S1 to S8, 4 cursor keys C ▲, C ►, C ▼ and C ◄, four function keys on the LOGO! TD: F1, F2, F3, and F4 as well as 16 blank outputs X1 to X16.

- LOGO! 0BA7

I1 to I24, AI1 to AI8, Q1 to Q16, AQ1 and AQ2, M1 to M27, and AM1 to AM16. Also available are 32 shift register bits S1.1 to S4.8, 4 cursor keys C ▲, C ►, C ▼ and C ◄, four function keys on the LOGO! TD: F1, F2, F3, and F4, as well as 64 blank outputs X1 to X64. If you have previously configured any of the network digital or analog inputs/outputs NI1 to NI64, NAI1 to NAI32, NQ1 to NQ64, and NAQ1 to NAQ16 in your circuit program from LOGO!Soft Comfort, after downloading the circuit program to LOGO!, these network digital or analog inputs/outputs are available in the LOGO!; however, you can not edit the rest of the program from the LOGO!, except for the Par parameter.

See the "Constants and connectors (Page 138)" topic for more details.

The following applies to inputs I1, I2, I7 and I8 of LOGO! 12/24..., LOGO! 24/24o and LOGO! 24C/24Co versions: If you use I1, I2, I7 or I8 in the circuit program, this input signal is digital. If you use AI3, AI4, AI1, or AI2, the input signal is analog. The numbering of the analog inputs is significant: AI1 and AI2 corresponded to I7 and I8 on the 0BA5 module. With the addition of two new analog inputs for the device series 0BA6 and 0BA7, these modules optionally use I1 for AI3 and I2 for AI4. See the graphical representation in the topic on "Maximum setup with expansion and communication modules (Page 34)". Also note that you can also use I3, I4, I5, and I6 as fast digital inputs.

The illustration above with numbered AI inputs shows the conceptual usage of the inputs, not the actual physical markings on the module.

**LOGO!'s connectors**

The term connector refers to all connections and states in LOGO! .

The digital I/O status can be '0' or '1'. Status '0' means that the input does not carry a specific voltage. Status '1' means that the input does carry a specific voltage.

The 'hi', 'lo' and 'x' connectors have been introduced to make it easier for you to create the circuit program:





'hi' (high) is assigned the status '1',

'lo' (low) is assigned the status '0'.

You do not have to use all of the connectors of a block. The circuit program automatically assigns the unused connectors a status that ensures proper functioning of the relevant block. If you prefer to do so, you can identify unused connectors with an 'x'.

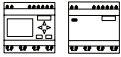
For information on the meaning of the term "block", refer to the topic on "Blocks and block numbers (Page 74)".

LOGO! has the following connectors :

Connectors	 LOGO! 0BA6	 LOGO!0BA7	 DM	 AM	 AM2AQ
Inputs	LOGO! 230RCE LOGO! 230RC/RC <sub>0</sub> LOGO! 24RC/RC <sub>0</sub>	Two groups: I1 to I4 and I5 to I8	I9 to I24	AI1 to AI8	none
	LOGO! 12/24RCE LOGO! 12/24RC/RC <sub>0</sub> LOGO! 24/24 <sub>0</sub> LOGO! 24C/24C <sub>0</sub>	I1, I2, I3-I6, I7, I8 AI3, AI4 ... AI1, AI2	I9 to I24	AI5 to AI8	
Outputs	Q1 to Q4		Q5 to Q16	none	AQ1, AQ2
lo	Logical '0' signals (off)				
hi	Logical '1' signals (on)				
x	An existing connection that is not used				
Flags	Digital flags: M1 to M27 Analog flags: AM1to AM6 (0BA6) AM1to AM16 (0BA7)				
Shift register bits	S1 to S8 (0BA6) S1.1 to S4.8 (0BA7)				
Network inputs <sup>1)</sup>	NI1 to NI64 (0BA7 only)				
Network analog inputs <sup>1)</sup>	NAI1 to NAI32 (0BA7 only)				
Network outputs <sup>1)</sup>	NQ1 to NQ64 (0BA7 only)				
Network analog outputs <sup>1)</sup>	NAQ1 to NAQ16 (0BA7 only)				

**DM:** Digital module

**AM:** Analog module

<sup>1)</sup> To make these four connectors available in a LOGO! 0BA7, you must configure them in the circuit program with LOGO!Soft Comfort V7.0 and download the circuit program to the LOGO! 0BA7 device.

## 3.2 EIB inputs/outputs

The application program "20 CO LOGO! 900E02" controls the communication between the LOGO! and the EIB/KNX bus via the communication module CM EIB/KNX.

By configuring the application program in ETS (EIB Tool Software), the division of the input and output area of the LOGO! can be defined as a "hardware channel" and as a "virtual channel" on the EIB/KNX bus.

This characteristic also applies for analog processing.

A communication object is assigned to each "hardware channel" and each "virtual channel" of LOGO! module.

The real-time clock of LOGO! can be used as a master or slave via the EIB/KNX bus.

The behavior of the communication objects of the communication module CM EIB/KNX, when the status of the EIB/KNX bus changes, can also be parameterised.

A "virtual input channel" can be used as a bus state; that is, a bus voltage failure can be reported.

The settings for analog values in LOGO! (Offset, Gain) do not affect the analog values for the CM EIB/KNX communication module (the output values of the CM EIB/KNX are always the raw values between 0 and 1000). In this case, you must parameterize customizing in the ETS.

### Functions of the application program

- Specification of the hardware configuration (number of local digital inputs and outputs, analog inputs)
- Selection of time master or slave
- Use of I24 as a bus status signal
- Behavior on bus voltage failure/recovery
- Input type as monoflop/normal for digital inputs via the EIB/KNX
- Output type as normal/dimmer/edge evaluation for digital outputs via the EIB/KNX
- Data type, adaptation, cyclical sending and sending on change in value for analog outputs via the EIB/KNX and analog inputs on LOGO!

Any further details about configuring the application program in ETS can be found in the current application program description.

For the application program see Siemens product database from version J onwards:

- <http://www.siemens.de/gamma>
- <http://www.siemens.de/logo>

### 3.3 Blocks and block numbers

This chapter shows you how to use LOGO! elements to create complex circuits and how blocks and I/O are interconnected.

In the topic "From circuit diagram to LOGO! Program (Page 76)" you will learn how to transform a conventional circuit into a LOGO! circuit program.

#### Blocks

A block in LOGO! represents a function that is used to convert input information into output information. Previously you had to wire the individual elements in a control cabinet or terminal box.

When you create the circuit program, you interconnect the blocks. To do so, simply select the connection you require from the **Co** menu. The menu name Co is an abbreviation of the term "Connector".

#### Logic operations

The most elementary blocks are the logic operations:

- AND
- OR
- ...

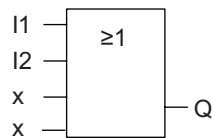

Inputs I1 and I2 are here connected to the OR block. The last two inputs of the block remain unused and are identified by the creator of the circuit program with an 'x'.

These special functions offer you significantly greater performance:

- Pulse relay
- Up/down counter
- On-delay
- Softkey
- ....

The chapter entitled "LOGO! functions (Page 137)" gives a full list of the LOGO! functions.

### Block representation on the LOGO! onboard display

The figure below shows a typical view of the LOGO! onboard display. As you can see, it can show only one block at a time. We have therefore introduced block numbers to help you check the circuit structure.

View of the LOGO! display

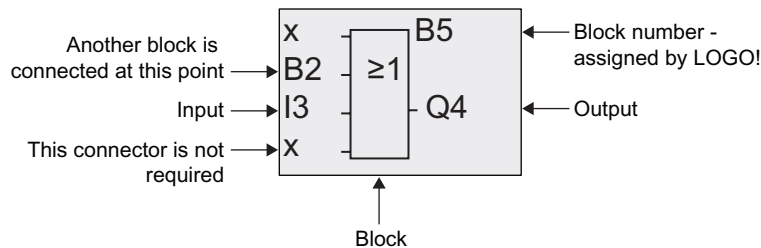

### Assigning a block number

LOGO! assigns each new block in a circuit program a block number.

LOGO! uses these block numbers to indicate the block interconnections. This means that these numbers are mainly an aid to your orientation in the circuit program.

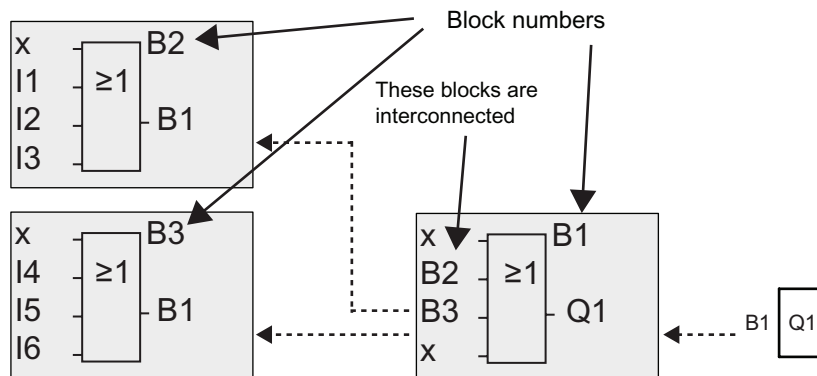

The figure above shows you three views of the LOGO! onboard display, which represent the circuit program. As you can see, LOGO! interconnects the blocks using their numbers. To scroll the circuit program, use the key ◀.

### Advantages of block numbers

You can connect almost any block to an input of the current block by means of its block number. In this way, you can reuse the interim results of logical or other operations, reduce programming effort, save memory space and clean up your circuit layout. To do so, however, you need to know how LOGO! has named the blocks.

**Note**

An organizational program chart can be a valuable aid when you create the circuit program because you can enter in this chart all the block numbers that LOGO! assigns.

By using the LOGO!Soft Comfort software to program LOGO!, you can directly create a function chart of your circuit program. LOGO!Soft Comfort also allows you to assign eight-character names to up to 100 blocks, and to view these on the LOGO! onboard display in parameter assignment mode. See the topic "The four golden rules for operating LOGO! (Page 79)".

### 3.4 From circuit diagram to LOGO! program

#### View of a circuit diagram

The following illustration shows a typical circuit diagram that represents the circuit logic:

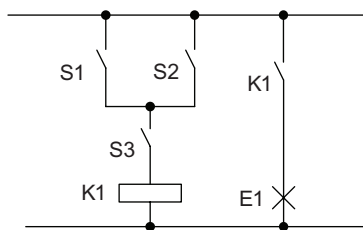

Load E1 is switched on and off by means of the switches (S1 OR S2) AND S3.  
Relay K1 picks up when condition (S1 OR S2) AND S3 is met.

#### Creating this circuit with LOGO!

In LOGO! you create a circuit logic by interconnecting blocks and connectors:

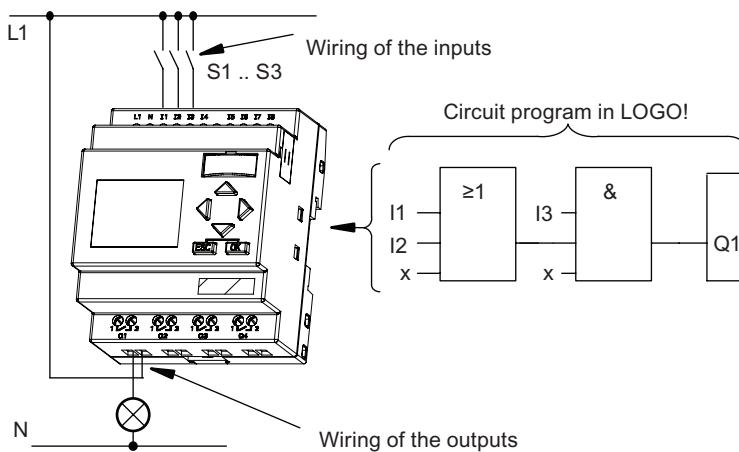



**Note**

Although you have four inputs available for logic operations (Page 142), most of the views will only show three inputs for reasons of clarity. You program this fourth input and assign parameters just like you do with the other three inputs.

To create a circuit logic in LOGO!, start at the circuit output.

The output is the load or relay that is to be switched.

Convert the circuit logic into blocks by working through the circuit, starting at the output and ending at the input:

Step 1: The make contact S3 is interconnected in series to output Q1 and to a further circuit element. A series connection corresponds with the AND block:

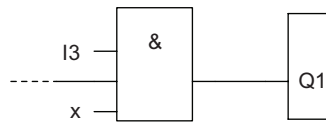

Step 2: S1 and S2 are connected in parallel. A parallel circuit corresponds with the OR block:

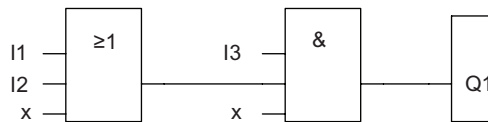
**Unused inputs**

The circuit program automatically assigns the unused connectors a status that ensures proper functioning of the relevant block. If you like, you can label unused connectors with an 'x' identifier.

In our example we shall use only two inputs of the OR block and two inputs of the AND block; the relevant unused third and fourth inputs are identified at the connector with an 'x'.

Now connect the I/O to LOGO! .

**Wiring**

Connect the switches S1 to S3 to the screw terminals of your LOGO! :

- S1 to connector I1 of LOGO!
- S2 to connector I2 of LOGO!
- S3 to connector I3 of LOGO!

The output of the AND block controls the relay at output Q1. The load E1 is connected to output Q1.

Wiring example

The following figure shows you the wiring, based on a 230 V AC version of LOGO!.

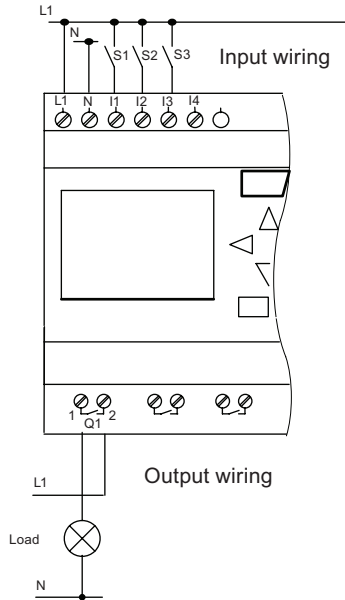

## 3.5 The four golden rules for operating LOGO!

### Rule 1: Changing the operating mode

- You create the circuit program in programming mode. After power is on, and when the display shows "No Program / Press ESC", press the **ESC** key to select programming mode.
- Timer and parameter values of an existing circuit program can be edited both in **parameter assignment mode** and in **programming mode**. During **parameter assignment** LOGO! is in **RUN mode**; that is, it continues executing the circuit program (see the topic "Configuring LOGO! (Page 287)"). To work in **programming mode**, you need to terminate the circuit program by calling the "**Stop**" command.
- Select the 'Start' command on the main menu to set **RUN mode**.
- When the system is in **RUN**, you can return to **parameter assignment mode** by pressing the **ESC** key.
- When **parameter assignment mode** is open and you want to return to **programming mode**, select the "**Stop**" command from the parameter assignment menu, and confirm "**Stop Prg**" prompt with "**Yes**". To do so, move the cursor to "**Yes**" and confirm with OK.

For more details on operating modes, refer to the Appendix topic "LOGO! Menu structure (Page 353)".

---

#### Note

The following applies to 0BA2 device versions and earlier:

- You can open programming mode by pressing ◀▶+OK.
  - You set parameter assignment mode by pressing **ESC+OK**.
- 

### Rule 2: Outputs and inputs

- Always create your circuit program by working from the output to the input.
- You can connect an input to several outputs, but not the same output to several inputs.
- Within the same program path you may not connect an output to an upstream input. For such internal recursions you should interconnect flags or outputs.

### **Rule 3: Cursor and cursor movement**

The following applies when you edit a circuit program:

- You can move the cursor when it appears in the form of an underscore:
  - Press ◀, ▶, ▼ or ▲ to move the cursor in the circuit program.
  - Press **OK** to change to "Select connector/block".
  - Press **ESC** to exit programming mode.
- You select a connector/block - when the cursor appears as a solid square:
  - Press ▼ or ▲ to select a connector or a block.
  - Confirm with **OK**.
  - Press **ESC** to return to the previous step.

### **Rule 4: Planning**

- Before you start to create a circuit program, you should either first create a design on paper or program LOGO! directly using LOGO!Soft Comfort.
- LOGO! can only save complete and faultless circuit programs.

## 3.6 Overview of LOGO! menus

### LOGO! 0BA6 menus

The following illustration shows an overview of LOGO! 0BA6 menus:

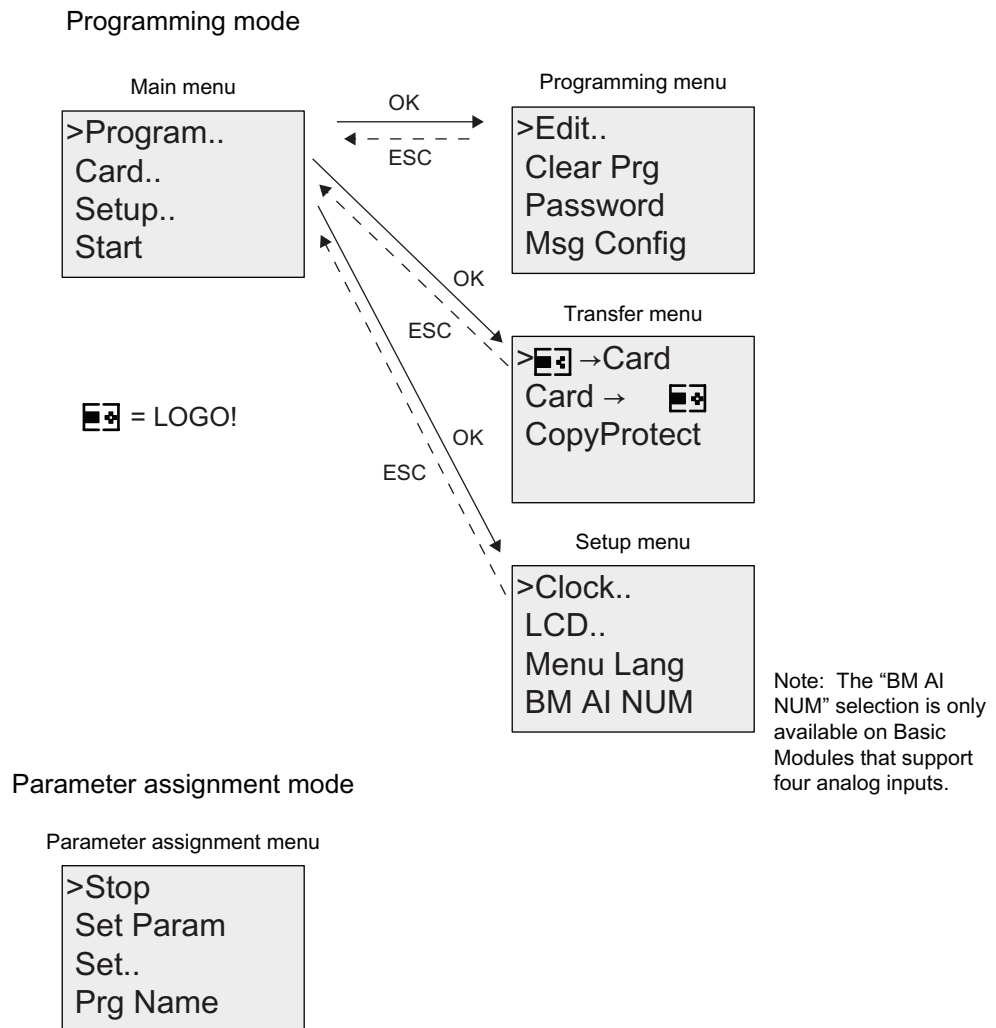

**LOGO! 0BA7 menus**

The following illustration shows an overview of LOGO! 0BA7 menus:

Programming mode

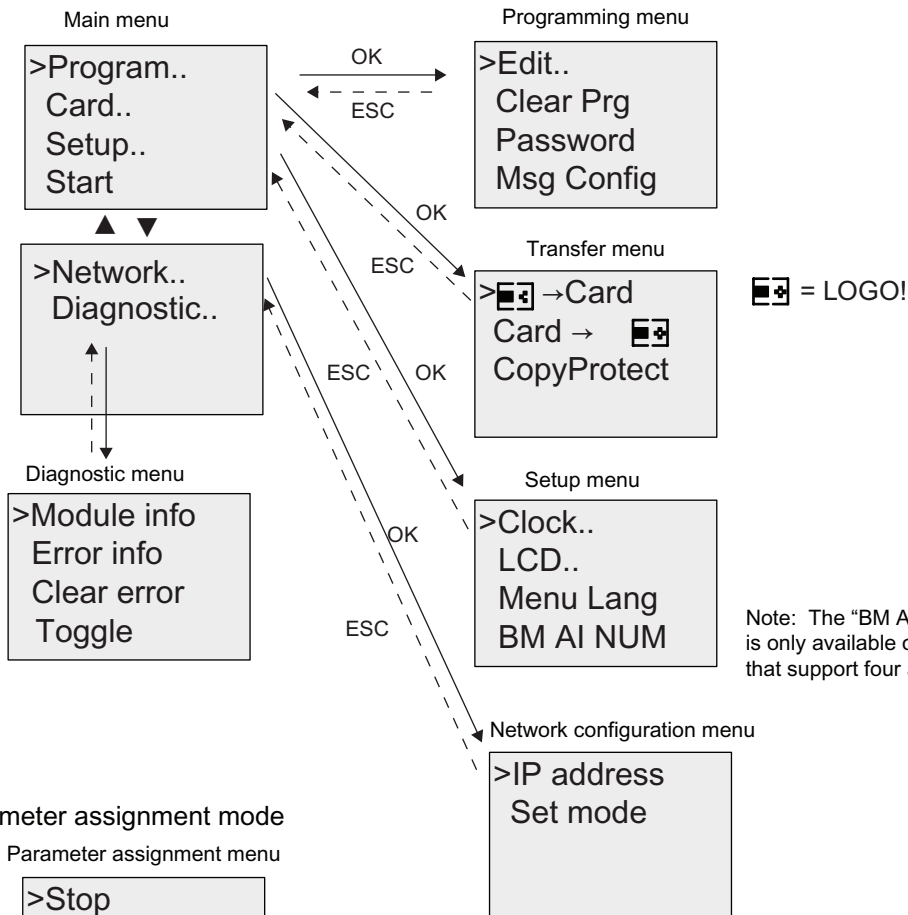

Parameter assignment mode

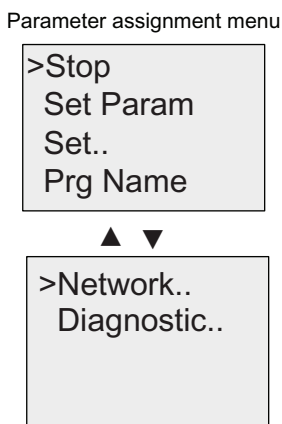

For more details on these menus, refer to the Appendix topic entitled "LOGO! menu structure (Page 353)".

The LOGO! TD menus provide configuration settings (Page 359) for the LOGO! TD. These menus are a subset of the LOGO! menus and are operated in much the same way.

## 3.7 Writing and starting the circuit program

The example below shows how to create a program for your circuit design in LOGO!.

### 3.7.1 Selecting programming mode

You have connected LOGO! to the power supply and switched it on. The display now shows you the following message:

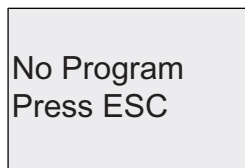

```
No Program
Press ESC
```

Switch LOGO! to programming mode by pressing **ESC**. This will take you to the main menu of LOGO!.

The **LOGO! 0BA6 main menu** is as shown below:

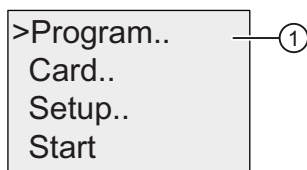

```
>Program.. ①
Card..
Setup..
Start
```

The **LOGO! 0BA7 main menu** is as shown below:

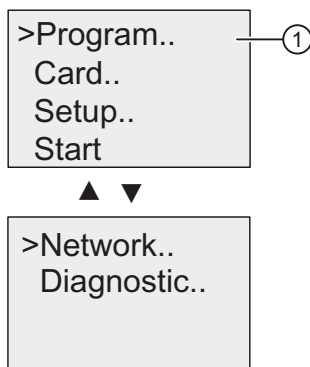

```
>Program.. ①
Card..
Setup..
Start

▲ ▼

>Network..
Diagnostic..
```

The first character in the first line is the ">" cursor. Press ▲ and ▼ to move the ">" cursor up and down. Move it to "①" and confirm with **OK**. LOGO! opens the programming menu.

The LOGO!'s programming menu is as shown below:

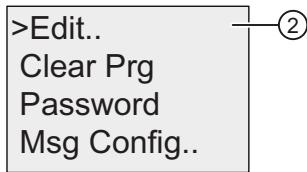

Here you can also move the ">" cursor by pressing ▲ and ▼. Move the ">" cursor to "②" and confirm with **OK**.

The **Edit menu of LOGO!** is as shown below:

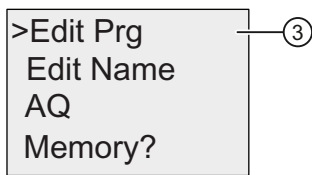

Move the ">" cursor to "③" (for editing the circuit program) and confirm with **OK**. LOGO! now shows you the first output:

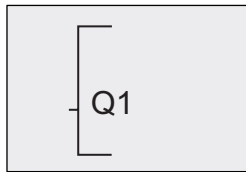

The first output of LOGO!

You are now in programming mode. Press ▲ and ▼ to select the other outputs. Now start to edit your circuit program.

---

### Note

Because we have not yet saved a **password** for the circuit program in LOGO!, you can directly enter editing mode. When you select "Edit" after you have saved a password-protected circuit program, you are prompted to enter a password and to confirm it with **OK**. You can only edit the program after you have entered the correct password (Page 91).

---



### 3.7.2 The first circuit program

Let us now take a look at the following parallel circuit consisting of two switches.

#### Circuit diagram

The corresponding circuit diagram:

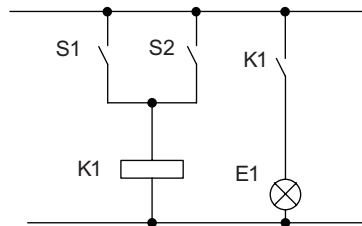

The load is switched on with S1 OR S2. LOGO! interprets this parallel circuit as an 'OR' logic, because S1 OR S2 switches on the output.

Translated into a LOGO! circuit program this means: Relay K1 is (at output Q1) controlled by means of an OR block.

#### Circuit program

S1 is connected to the I1 and S2 to the I2 input connector of the OR block.

The corresponding layout of the circuit program in LOGO!:

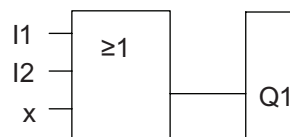

#### Wiring

The corresponding wiring:

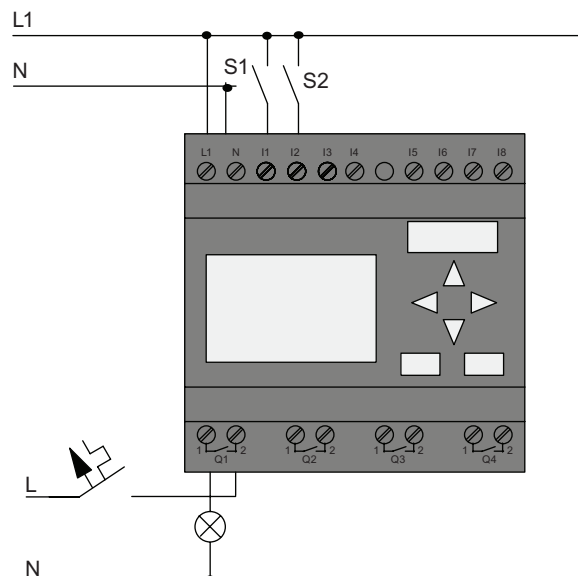

S1 switches input I1, while S2 switches input I2. The load is connected to the relay Q1.

### 3.7.3 Circuit program input

Let us now write the circuit program, starting at the output and working towards the input. LOGO! initially shows the output:

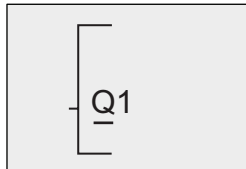

The first LOGO! output

You will see an underscore below the Q in Q1, which is the **cursor**. The cursor indicates your current position in the circuit program. You can move the cursor by pressing the ▲, ▼, ◀ and ▶ keys. Now press the ◀ key. The cursor moves to the left.

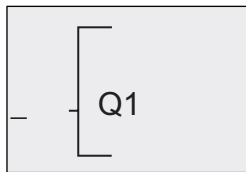

The cursor indicates your current position in the circuit program.

At this point you enter only the first (OR) block. Press **OK** to select editing mode.

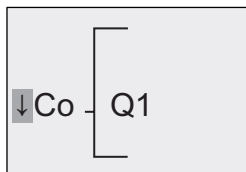

The cursor is displayed as a solid square:  
You can now select a connector or a block

The cursor no longer appears in the form of an underscore; but instead as a flashing solid square. LOGO! offers you various options here.

Select GF (basic functions) by pressing the ▼ key until GF appears, and confirm with **OK**. LOGO! now shows the first block from the list of basic functions:

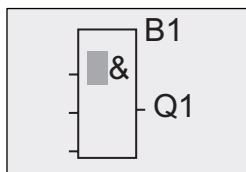

The AND is the first block of the basic functions list. The solid square cursor prompts you to select a block.

Now press ▼ or ▲ until the OR block appears on the display:

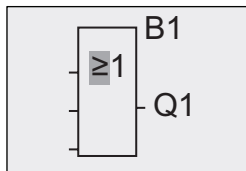

The solid square cursor is still positioned on the block.

Press **OK** to confirm your entries and exit the dialog.

The display now shows:

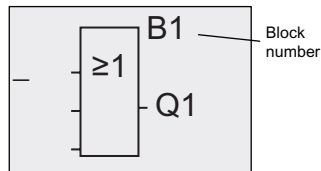

Your complete circuit program layout

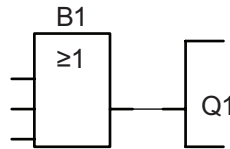

You have now entered the first block. Each new block is automatically assigned a block number. The only thing left to do is interconnect the block inputs. This is how it is done:

Press **OK**.

The display now shows:

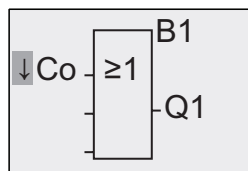

Select the **Co** list: Press **OK**

The display now shows:

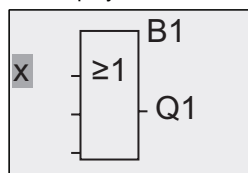

The first element of the **Co** list is the "Input 1" character, namely "I1".

---

### Note

Press ▼ to go to the start of the Co list: I1, I2 ... to I<sub>o</sub>. Press ▲ to go to the end of the Co list: I<sub>o</sub>, h<sub>i</sub>, ... to I1.

Inputs F1, F2, F3, and F4 are new as of the 0BA6 device series. They correspond to the four function keys on the optional LOGO! TD.

More shift register bits (S1.1 to S4.8), blank connectors (X1 to X64) and analog flags (AM1 to AM16) are available in the 0BA7 device series.

Network digital inputs (NI1 to NI64), network analog inputs (NAI1 to NAI32), network digital outputs (NQ1 to NQ64), and network analog outputs (NAQ1 to NAQ16) are new connectors for the 0BA7 device series. They are not preconfigured in the LOGO! 0BA7. You can only configure them from LOGO!Soft Comfort V7.0 for a circuit program and download the program to the LOGO! 0BA7 to make them available in your LOGO! 0BA7 device.

---

3.7 Writing and starting the circuit program

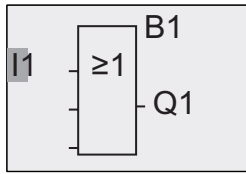

Press **OK**. I1 is now connected to the input of the OR block. The cursor jumps to the next input of the OR block.

The display now shows:

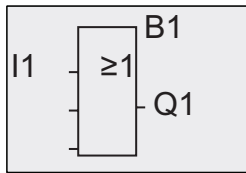

Your complete circuit program in LOGO! up to now:

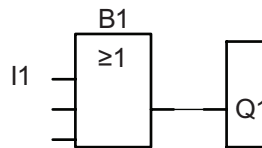

Now you connect input I2 to the input of the OR block:

1. Switch to editing mode: Press **OK**
2. Select the **Co** list: Press **▼** or **▲**
3. Confirm the Co list with: Press **OK**
4. Select **I2**: Press **▼** or **▲**
5. Apply I2: Press **OK**

I2 is now connected to the input of the OR block:

The display now shows:

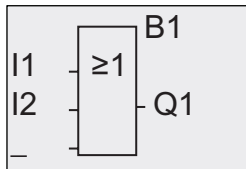

Your complete circuit program in LOGO! up to now:

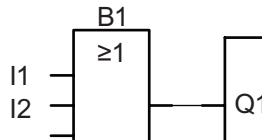

We do not need the last two inputs of the OR block for this circuit program. You can mark the unused inputs with an 'x'. Enter the 'x' character twice:

1. Switch to editing mode: Press **OK**
2. Select the **Co** list: Press **▼** or **▲**
3. Accept the Co list: Press **OK**
4. Select 'x': Press **▼** or **▲**
5. Apply x: Press **OK**

The display now shows:

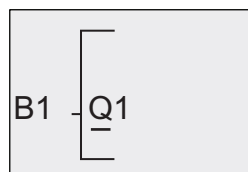

This is the layout of your circuit program:

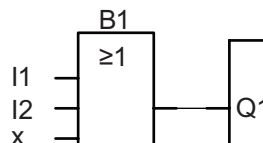

**Note**

You can invert individual inputs of the basic and special functions; that is, if an input carries a logical "1" signal, the circuit program will output a logical "0". On the other hand, a logical "0" is inverted into a logical "1" signal.

To invert an input, move the cursor to the relevant position, e.g.:

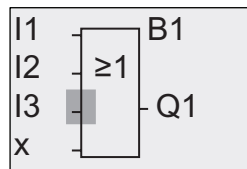

Confirm with **OK**.

Now press **▲** or **▼** to invert this input: →

Next, press **ESC**.

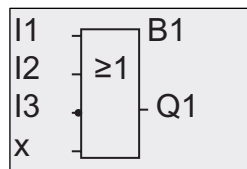

Your circuit program layout:

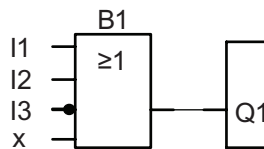

You can review your first circuit program by pressing **◀** or **▶** to move the cursor through the circuit program.

We shall now exit circuit programming mode. To return to the programming menu: Press **ESC**

**Note**

LOGO! has now saved your circuit program to nonvolatile memory. The circuit program remains in the LOGO! memory until you explicitly delete it.

You can save the actual values of special functions in the case of a power outage assuming that these functions support the "Retentive" parameter and that the necessary program memory is available. The Retentive parameter is deactivated when you insert a function; to use it, you must enable this option.

### 3.7.4 Assigning a circuit program name

You can assign your circuit program a name that consists of up to 16 uppercase/lowercase letters, numbers and special characters.

When LOGO! is in the view below, follow these steps:

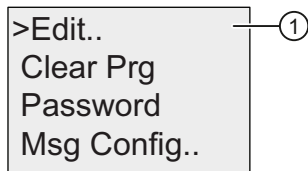

1. Press ▼ or ▲ to move the ">" cursor to "①".
2. To confirm "①", press **OK**.

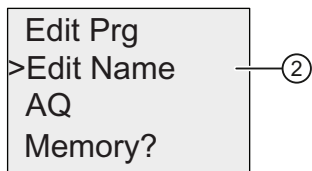

3. Press ▼ or ▲ to move the ">" cursor to "②".
4. To confirm "②", press **OK**.

Press ▲ and ▼ to list the alphabet, numbers and special characters, either in ascending or descending order. You can select any letter, number or character.

To enter a space character, simply move the cursor with ► to the next position. This character is the first one in the list.

Examples:

Press ▼ once to select an "A". Press ▲ four times to select "{", etc.

The following character set is available:

	A	B	C	D	E	F	G	H	I	J	K	L	M	N	O
P	Q	R	S	T	U	V	W	X	Y	Z	a	b	c	d	e
f	g	h	i	j	k	l	m	n	o	p	q	r	s	t	u
v	w	x	y	z	0	1	2	3	4	5	6	7	8	9	!
"	#	\$	%	&	'	(	)	*	+	,	-	.	/	:	;
<	=	>	?	@	[	\	]	^	_	'	{		}	~	

Assuming that you want to name your circuit program "ABC", proceed as follows:

1. Select "A": Press ▼
2. Move to the next letter: Press ►
3. Select "B": Press ▼
4. Move to the next letter: Press ►
5. Select "C": Press ▼
6. Confirm the complete name: Press **OK**

Your circuit program is now named "**ABC**", and you are returned to the programming menu.

To **change** the name of your circuit program, proceed in the same way.

---

**Note**

You can change the name of the circuit program only in programming mode. You can **read** the name both in programming **and** in parameter assignment mode.

---

### 3.7.5 Password for circuit program protection

You can protect a circuit program from unauthorized access by assigning it a password.

You can only assign or deactivate a program password from a LOGO! Basic or from LOGO!Soft Comfort. You can only change a program password from a LOGO! Basic. If you have assigned a program password, and are using a LOGO! TD (version ES4 or later) together with a LOGO! Base Module (version ES4 or later), you must enter this password if you want to change LOGO! from RUN mode to STOP mode from the LOGO! TD. You can not stop the execution of the circuit program in LOGO! from the LOGO! TD without entering the password.

---

**Note**

This password protection function is only available in the LOGO! TD with version number ES4 or later. This function is **only available** under the following conditions:

- The version number of both the LOGO! Base Module and the LOGO! TD installed is at least ES4
- LOGO! is currently in RUN mode and you want to switch to STOP mode

There is only one circuit program protection password that you can assign for LOGO!. You can only assign it from the LOGO! Basic or from LOGO!Soft Comfort. To change LOGO! from RUN to STOP from the LOGO! TD, you must enter the password from the LOGO! TD as described below in the section "Changing LOGO! from RUN to STOP mode from the LOGO! TD".

LOGO! 0BA7 provides an additional password menu command for your changing LOGO!'s communication mode from normal (client/server) mode to slave mode or vice versa.

---

### Assigning a program password from the LOGO! Basic

A password can have a maximum length of 10 characters, and consists only of uppercase letters. On the LOGO! Basic, you can assign, edit or deactivate the password only from the "Password" menu.

To enter a password, follow these steps in the programming menu:

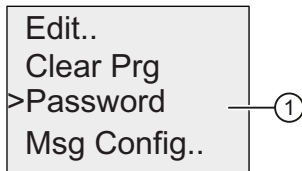

1. Move the ">" cursor to "①": Press ▼ or ▲
2. Confirm "①": Press **OK**

Press ▼ or ▲ to move up and down the alphabet to select your letters. Because the LOGO! Basic only provides uppercase letters for the password, you can quickly access letters "at the end" of the alphabet (in this example, English) by using the ▲ button:

Press ▲ once to select "Z"

Press ▲ twice to select "Y", etc.

The display appears as follows:

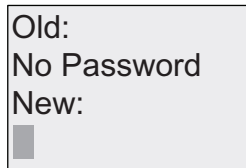

To enter a password of "AA", for example, the procedure is the same as for entering the name of the circuit program.

3. Select "A": Press ▼
4. Move to the next letter: Press ►
5. Select "A": Press ▼

The display now appears as follows:

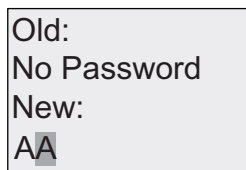

6. Confirm the password: Press **OK**

Your circuit program is now protected with the password "AA", and you are returned to the programming menu.



**Note**

You can cancel the input of a new password with **ESC**. In this case, the LOGO! Basic returns to the programming menu without saving the password.

You can also set your password using LOGO!Soft Comfort. You cannot edit a password-protected circuit program in a LOGO! Base Module or upload it to LOGO!Soft Comfort unless you enter the correct password.

To allow you to create and edit a circuit program for a protected module (Card), you first need to assign a password to this new program (Page 305).

**Changing the password from the LOGO! Basic**

You must know the current password in order to change it. From the programming menu, follow these steps to change the password:

1. Move the '>' cursor to "①": Press ▼ or ▲

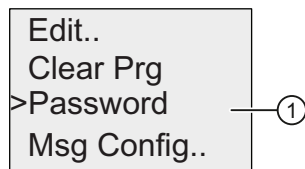

2. Confirm "①": Press **OK**

Enter your old password (in our case: 'AA') by repeating steps 3 through 6 as described earlier. Press **OK**. The display now shows:

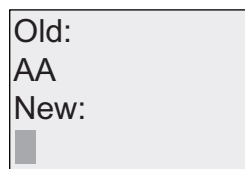

Now you can enter the new password, for example, "ZZ".

3. Select "Z": Press ▲
4. Move to the next letter: Press ►
5. Select "Z": Press ▲

The display now shows:

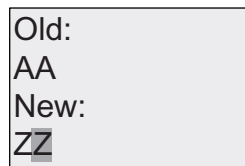

6. Confirm your new password: Press **OK**

Your new password "ZZ" is now set, and you are returned to the programming menu.

### Deactivating the password from the LOGO! Basic

To deactivate the password to allow, for example, another user to edit your circuit program, you must know your current password (in our example "ZZ"), the same as if you were changing it.

To deactivate the password, follow these steps in the programming menu:

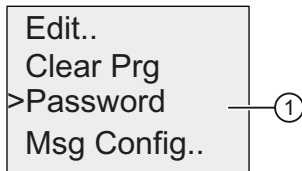

1. Move the '>' cursor to "①": Press ▼ or ▲
2. Confirm "①": Press **OK**

Enter your current password as described in steps 3 to 5 above. Confirm your entries with **OK**.

The display shows:

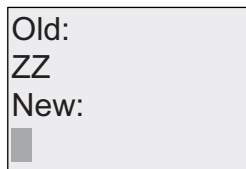

**Clear** the password by leaving the input box **blank**:

3. Confirm the "blank" password: Press **OK**

The password is "cleared", and LOGO! returns to the programming menu.

---

#### Note

This action disables the password prompt, and thus permits access without a password.

Leave the password **deactivated** for quicker progress through the remaining exercises and examples.

---

### Password: Wrong Password!

If you enter the **wrong** password and confirm the input with **OK**, the LOGO! Basic does not open editing mode, but returns to the programming menu. This repeats itself over and over again until you enter the correct password.

### Changing LOGO! from RUN to STOP mode from the LOGO! TD

A change from RUN mode to STOP mode from the LOGO! TD requires password entry if one is assigned. You must know the existing password if one is assigned. If there is no password assigned on the LOGO! Base Module, the LOGO! TD will not prompt you for password entry.

To change LOGO! from RUN mode to STOP mode from the LOGO! TD when LOGO! is password-protected, follow these steps:

1. On the LOGO! TD, press **ESC** to switch LOGO! from RUN mode to STOP mode. LOGO! TD shows the following menu:

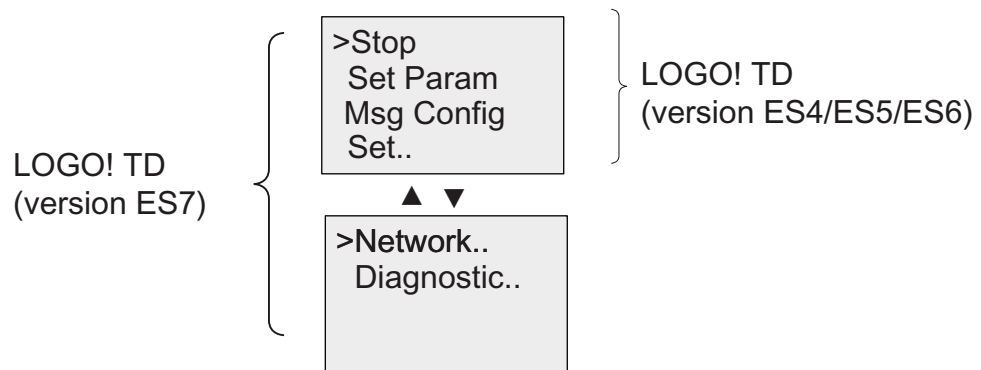

2. Press **OK**. The LOGO! TD shows you the following display:

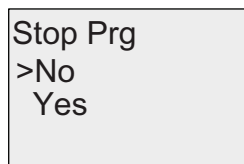

3. Press **▼** to move the cursor to "Yes", and press **OK**. Enter the correct password (in this case: "ZZ"). If you enter an incorrect password, the LOGO! TD returns to the display in Step 1.

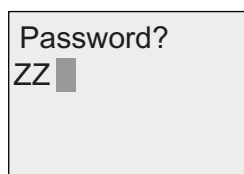

4. Press **OK** to exit the password entry screen form. The LOGO! TD opens the main menu:

The main menu of the LOGO! TD (version ES6 or earlier):

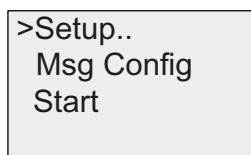

The main menu of the LOGO! TD (version ES7):

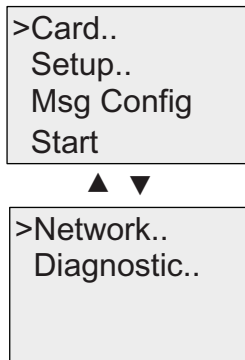

LOGO! changes to STOP mode.

---

**Note**

Whenever the LOGO! TD is shut down, the password is reset. The next time you start it and access this password-protected function (RUN to STOP), you will be prompted for password entry on the LOGO! TD.

If the password entry screen form (as shown in Step 3) has stayed for more than one minute since you pressed any key on the LOGO! TD, the LOGO! TD automatically returns you to one of the following displays:

- Display of the current time-of-day and date, if the LOGO! Base Module that connects to the LOGO! TD is a LOGO! Basic without active messages
- Display of active messages , if the LOGO! Base Module that connects to the LOGO! TD is a LOGO! Basic with active messages
- Display of the values of the digital inputs, if the LOGO! Base Module that connects to the LOGO! TD is a LOGO! Pure

The LOGO! TD can also change LOGO! from STOP to RUN mode, but no password is required in this case.

---

### 3.7.6 Switching LOGO! to RUN mode

In the main menu, select RUN to start LOGO!.

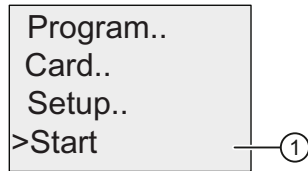

1. Return to the main menu: Press **ESC**
2. Move the '>' cursor to "①": Press **▲** or **▼**
3. Confirm "①": Press **OK**

LOGO! runs the circuit program and shows the following display:

Display field of LOGO! in RUN mode

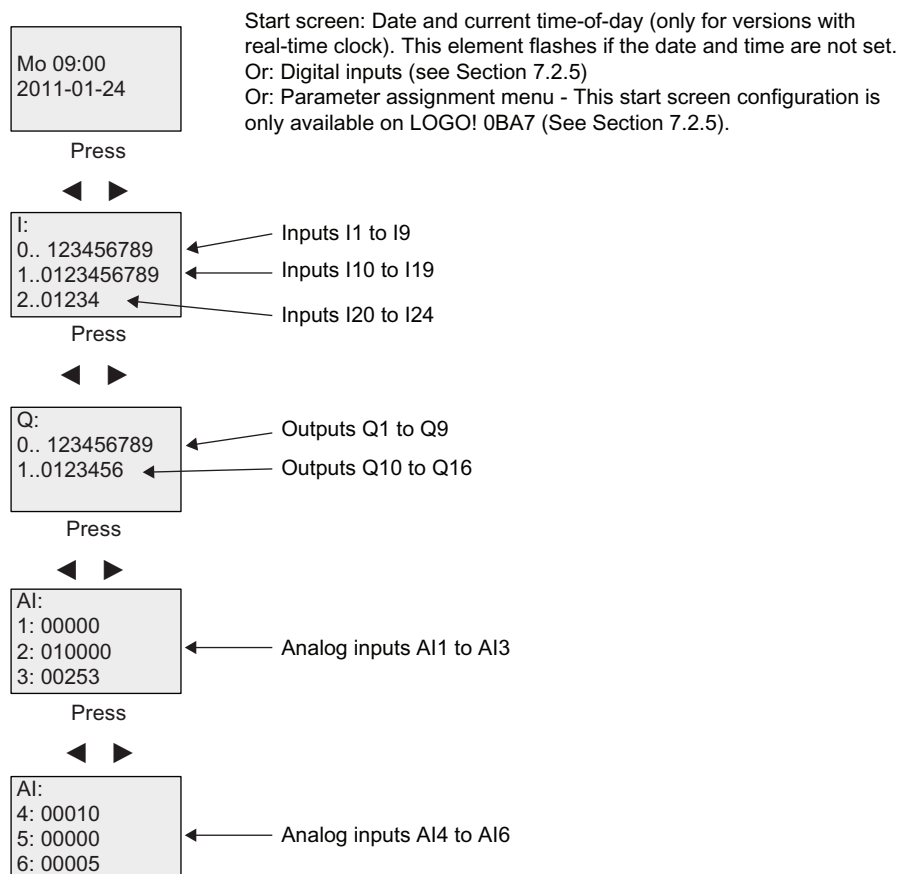

3.7 Writing and starting the circuit program

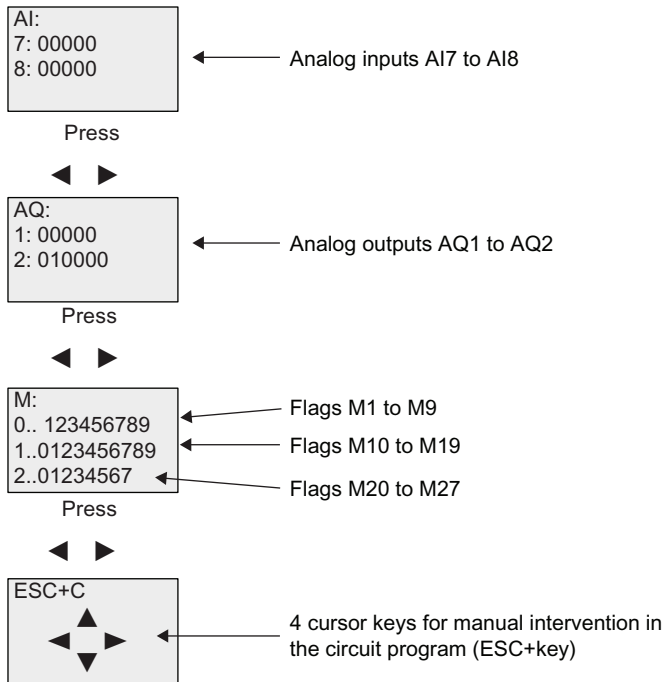

What is meant by: "LOGO! is in RUN"?

In RUN mode, LOGO! executes the circuit program. To do so, LOGO! first reads the status at the inputs, determines the status of the outputs by means of the circuit program, and switches these on or off according to your settings.

This is how LOGO! indicates the I/O status:

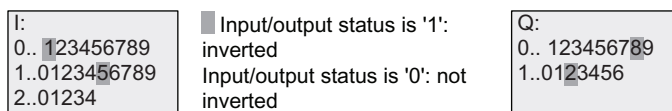

Status indication on the display

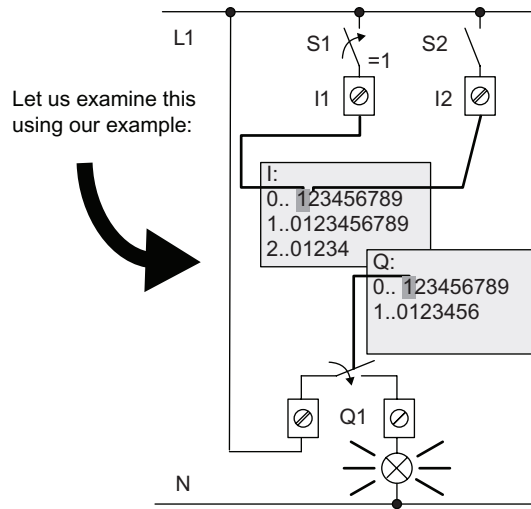

When switch S1 is closed, the status at input I1 is high.  
 LOGO! computes the output states by means of the circuit program.

Output Q1 = "1", in this case.  
 When Q1 = "1", LOGO! sets relay Q1, and the load connected to Q1 is supplied with voltage.

### 3.7.7 Second circuit program

Up to this point, you have successfully created your first circuit and assigned it a name and, if desired, a program password. In this section we will show you how to modify existing circuit programs and how to use the special functions.

Using this second circuit program, we will show you how to:

- Add a block to an existing circuit program.
- Select a block for a special function.
- Assign parameters.

#### Modifying circuits

We shall use the first circuit program as a basis for the second, with some slight modifications.

First of all take a look at the circuit diagram for the second circuit program:

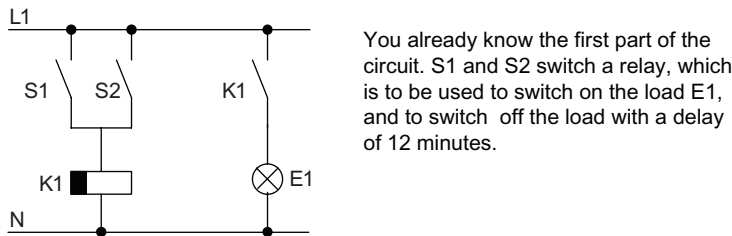

This is the circuit program layout in LOGO!:

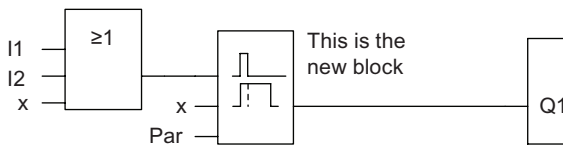

You can see the OR block and the output relay Q1 we have already used in the first circuit program. The only difference is the new off-delay block.

#### Editing the circuit program

Switch LOGO! to programming mode.

As a reminder:

1. Switch LOGO! to programming mode  
(in RUN: Press **ESC** to enter the parameter assignment mode. Select the '**Stop**' command, confirm with **OK**, then move the '>' cursor to '**Yes**', and once again confirm with **OK**). For additional details, see the topic "The four golden rules for operating LOGO! (Page 79)".
2. On the main menu, select "**Program**"
3. On the Programming menu, select "**Edit**", confirm with **OK**. Next, select "**Edit Prg**" and confirm with **OK**.  
If required, enter your password at the prompt and confirm with **OK**.

You can now modify the current circuit program.



### Adding a block to a circuit program

Press ◀ to move the cursor to the B in B1 (B1 is the number of the OR block):

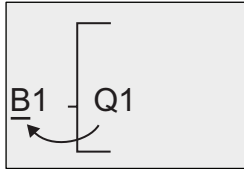

Insert the new block at this position.  
Confirm with **OK**.

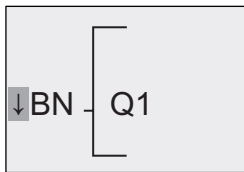

LOGO! shows you the BN list

Press ▼ to select the SF list:

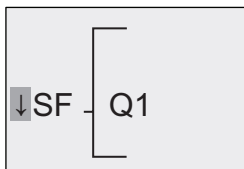

The SF list contains the special function blocks.

Press **OK**.

The block of the first special function is shown:

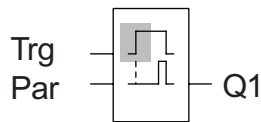

When you select a special or basic function block, LOGO! shows you the relevant function block. The solid square cursor is positioned on the block. Press ▼ or ▲ to select the required block.

Select your block (off-delay, see the next figure), and then press **OK**:

Before you press 'OK',  
this shows the entry

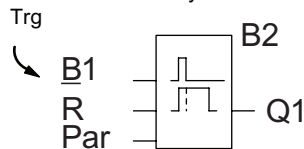

The added block is assigned the block number B2. The cursor is positioned at the top input of the added block.

The B1 block previously connected to Q1 is automatically connected to the uppermost input of the new block. Note that you can only interconnect digital inputs with digital outputs or analog inputs with analog outputs. The 'old' block will otherwise be lost.

The off-delay block has three inputs. At the top is the trigger input (Trg) you use to start the off-delay time. In our example, the OR block B1 triggers the off-delay. You reset the time and the output with a signal at the reset input. Set the off-delay time at parameter T of the input Par.

In our example we do not use the reset input of the off-delay function, and we identify it with an 'x' connector.

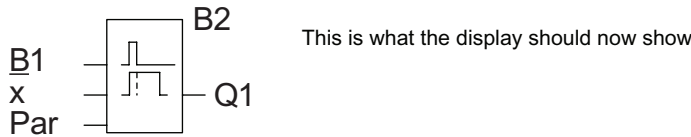

### Assigning block parameters

Now you set the off-delay time T:

1. Move the cursor to **Par**, if it not already at this position: Press ▲ or ▼
2. Switch to editing mode: Press **OK**

LOGO! shows the parameters in the parameter assignment window:

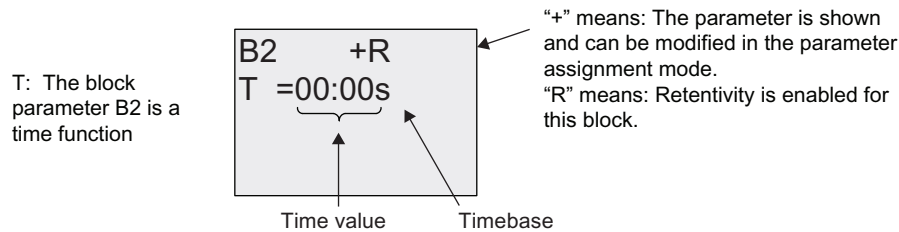

To change the time value:

- Press ◀ and ▶ to position the cursor.
- Press ▲ and ▼ to modify the value at the relevant position.
- Confirm your entries with **OK**.

### Setting the time

Set the time T = 12:00 minutes:

1. Move the cursor to the first digit: Press ◀ or ▶
2. Select the digit '1': Press ▲ or ▼
3. Shift the cursor to the second digit: Press ◀ or ▶
4. Select digit '2': Press ▲ or ▼
5. Move the cursor to the unit: Press ◀ or ▶
6. Select the timebase 'm' (for minutes): Press ▲ or ▼

### Showing/hiding parameters - the parameter protection mode

If you want to show/hide the parameter and allow/prevent its modification in parameter assignment mode:

1. Move the cursor to the protection mode: Press ◀ or ▶
2. Select the protection mode: Press ▲ or ▼

The display should now show:

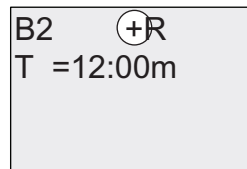

or

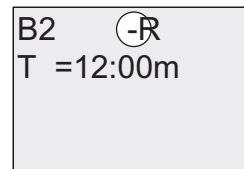

Protection mode +: The value of the time T can be modified in parameter assignment mode

Protection mode -: The value of the time T is hidden in parameter assignment mode

3. Confirm your entries with: **OK**

### Enabling/disabling retentivity

To decide whether you want to retain your current data after a power failure or not:

1. Move the cursor to the retentivity setting: Press ◀ or ▶
2. Select the retentivity setting: Press ▲ or ▼

The display now shows:

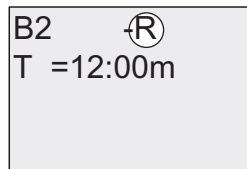

or

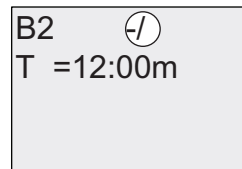

Retentivity R: Current data is retained

Retentivity /: Current data is not retained

3. Confirm your entries with **OK**

---

#### Note

For further information on the protection mode, refer to the topic "Parameter protection (Page 153)".

For further information on retentivity, refer to the topic "Retentivity (Page 153)".

You can modify the protection mode and retentivity setting only in programming mode. This is **not** possible in parameter assignment mode.

In this manual, the protection mode ("+" or "-") and retentivity ("R" or "/") settings are only shown in the displays where these can actually be changed.

---

### Verification of the circuit program

This program branch for Q1 is now completed. LOGO! shows you the output Q1. You can once again view the circuit program on the display. Use the keys to browse the circuit program; that is, press ◀ or ▶ to move from block to block, ▲ and ▼ to move between the inputs at a block.

### Closing the programming mode

Although you were shown how to exit the programming mode when you created your first circuit program, here is a reminder:

1. Return to the programming menu: Press **ESC**
2. Return to the main menu: Press **ESC**
3. Move the '>' cursor to **'Start'**: Press ▲ or ▼
4. Confirm 'Start': Press **OK**

LOGO! is back in RUN mode:

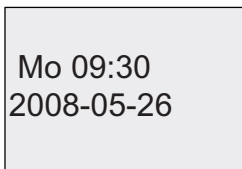

You can press ◀ or ▶ to scroll the pages and to monitor the I/O states.

### 3.7.8 Deleting a block

Let us assume you want to delete the block B2 from your circuit program and connect B1 directly to Q1.

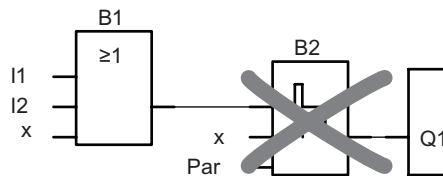

Proceed as follows:

1. Switch LOGO! to programming mode  
(as a reminder, refer to the topic "The four golden rules for operating LOGO!" (Page 79)).

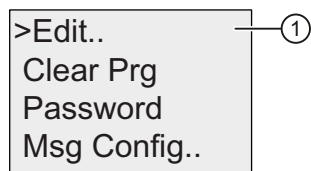

2. Select "①": Press ▲ or ▼
3. Confirm "①": Press **OK**  
(If required, enter your password and confirm with **OK**.)
4. Select "②": Press ▲ or ▼

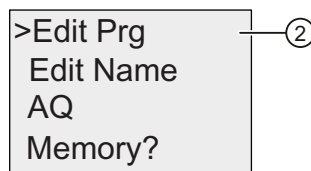

5. Confirm "②": Press **OK**
6. Move the cursor to B2, the input of Q1: Press ◀

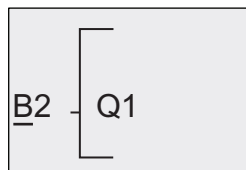

7. Confirm with **OK**.
8. Now replace block B2 with block B1 at output Q1. The procedure:
  - Select the **BN** list: Press ▲ or ▼
  - Accept the BN list: Press **OK**
  - Select '**B1**': Press ▲ or ▼
  - Apply '**B1**': Press **OK**

**Result:** Block B2 is deleted, because it is no longer used in the circuit. Block B1 has replaced B2 directly at the output.

### 3.7.9 Deleting block groups

Assuming you intend to delete the blocks B1 **and** B2 from the following circuit program (corresponds with the circuit program in the "Second circuit program (Page 100)" topic), proceed as follows:

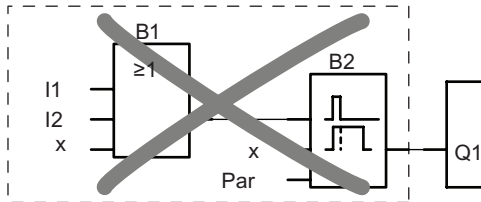

1. Switch LOGO! to programming mode (as a reminder, refer to the topic "The four golden rules for operating LOGO! (Page 79)").

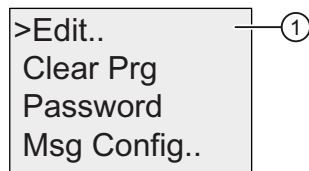

2. To select "①": Press ▲ or ▼
3. To confirm "①": Press **OK**  
(If required, enter your password and confirm with **OK**.)
4. To select "②": Press ▲ or ▼

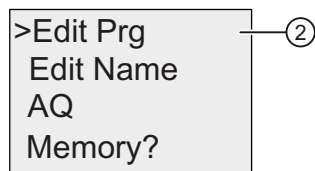

5. To confirm "②": Press **OK**
6. To move the cursor to the input of Q1; that is, to B2, press ◀:

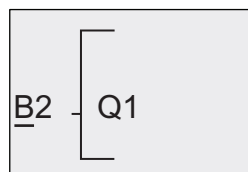

7. Confirm with **OK**.
8. Now set the connector 'x' at output Q1 instead of block B2. To do so:
  - Select the **Colist**: Press ▲ or ▼
  - Accept the Co list: Press **OK**
  - Select '**x**': Press ▲ or ▼
  - Apply '**x**': Press **OK**

**Result:** LOGO! deletes block B2 because it is no longer used in the circuit. LOGO! also deletes all blocks that connect to B2, in this case, block B1.

### 3.7.10 Correcting programming errors

Programming errors can be corrected easily in LOGO!:

- Provided editing mode is not yet closed, you can revert by one step by pressing **ESC**.
- If you have already configured all inputs, simply reconfigure the faulty input:
  1. Move the cursor to the faulty position
  2. Change to editing mode. Press **OK**
  3. Enter the correct input circuit

You can only replace a block with a block that has exactly the same number of inputs. However, you can delete the old block and then insert a new one. You can choose any new block.

### 3.7.11 Selecting analog output values for RUN/STOP transition

You can select the analog values that are output at the two analog outputs when LOGO! changes from RUN mode to STOP mode.

In the programming menu:

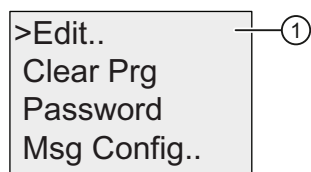

1. Move the ">" cursor to "①": Press ▼ or ▲
2. Select "①": Press **OK**
3. Move the ">" cursor to 'AQ': Press ▼ or ▲
4. Select "AQ": Press **OK**
5. Move the ">" cursor to "②": Press ▼ or ▲

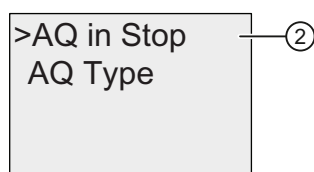

- 6. Select "②": Press **OK**

LOGO! shows the following display:



The first two rows show your choices. The bottom row shows the current setting for the analog output channels. The default setting is 'Last'.

You can select either "③" or "④". "④" means that the analog output values are held at their last value and "③" means that the analog output values are set to specific values. When LOGO! changes from RUN mode to STOP mode, the values of the analog outputs change as well, depending on the setting.

- 7. Select the desired output setting: Press ▲ or ▼.
- 8. Confirm your entry: Press **OK**

### Defining a specific analog output value

To output a specific analog value at the two analog outputs:

- 1. Move the '>' cursor to "③": Press ▲ or ▼

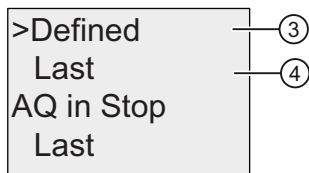

- 2. Confirm ' "③": Press **OK**

The display shows:

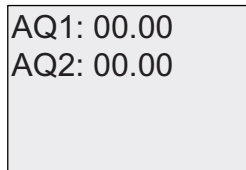

- 3. Enter a specific output value for each of the two analog outputs.
- 4. To confirm your entry: Press **OK**



### 3.7.12 Defining the type of analog outputs

Analog outputs can be either 0..10V/0..20mA, which is the default, or 4..20mA.

To define the type of analog outputs, follow these steps starting from the programming menu:

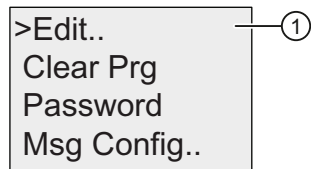

1. Move the ">" cursor to "①": Press ▼ or ▲
2. Select "①": Press **OK**
3. Move the ">" cursor to 'AQ': Press ▼ or ▲
4. Select 'AQ ': Press **OK**
5. Move the ">" cursor to "②": Press ▼ or ▲

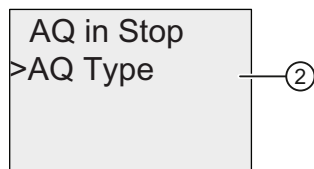

6. Select "②": Press **OK**

LOGO! shows the following display, for example:

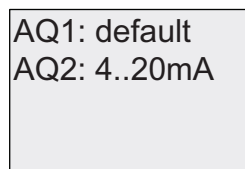

The defined type for each analog channel is shown. To change the type, continue as follows

7. Move to the AQ that you want to change. Press ◀ or ▶
8. Select either default (0..10V/0..20mA) or 4..20mA. Press ▼ or ▲
9. Confirm your selection. Press **OK**

### 3.7.13 Deleting the circuit program and password

To delete a circuit program and the password if one is defined:

1. Switch the LOGO! to programming mode (main menu). LOGO! opens the main menu:

LOGO! 0BA6 main menu:

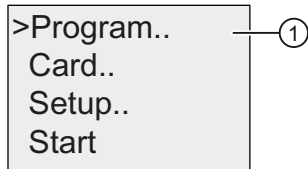

LOGO! 0BA7 main menu:

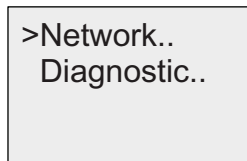
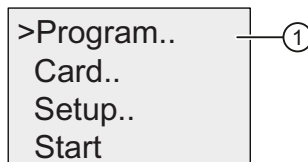

1. On the main menu, press ▲ or ▼ to move the '>' cursor to "①". Press **OK**. LOGO! opens the programming menu.
2. On the programming menu, move the '>' cursor to "②": Press ▲ or ▼

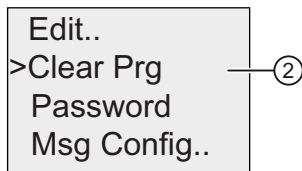

3. Confirm "②": Press **OK**

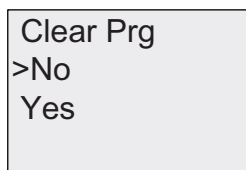

To cancel deletion of the circuit program, leave the '>' cursor at 'No' and press **OK**.

If you are sure that you want to delete the circuit program from memory:

4. Move the '>' cursor to 'Yes': Press ▲ or ▼

5. Press **OK**.

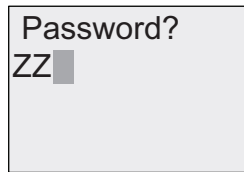

To prevent unintentional deletion of your circuit program, you are prompted to enter your password (provided you have assigned one).

6. Enter your password.
7. Press **OK**. The circuit program and the password are deleted.

### 3.7.14 Summertime/wintertime conversion

You can enable or disable automatic summertime/wintertime conversion

- in parameter assignment mode by calling the menu command "①"

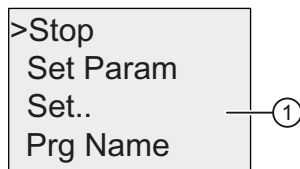

- in programming mode by calling the menu command "②"

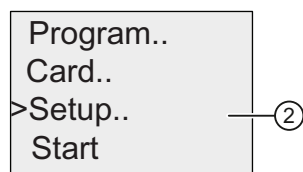

#### To enable/disable automatic S/W Time conversion in programming mode:

1. Switch LOGO! to programming mode. LOGO! displays the main menu.
2. Select "②": Press ▲ or ▼
3. Confirm "②": Press **OK**
4. Move the '>' cursor to "③": Press ▲ or ▼

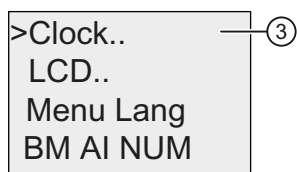

5. Confirm "③": Press **OK**

6. Move the '>' cursor to "④": Press ▲ or ▼

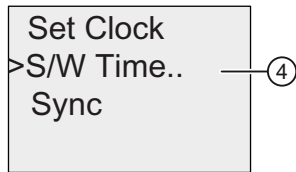

7. Confirm "④": Press **OK**

LOGO! shows the following display:

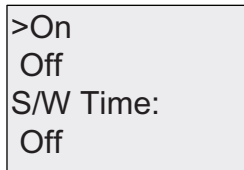

The current setting of automatic S/W Time conversion is shown on the bottom row. The default setting is 'Off': disabled.

**To enable/disable automatic S/W Time conversion in parameter assignment mode:**

If you want to enable/disable automatic S/W Time conversion in parameter assignment mode, select "①" in the parameter assignment menu, then menus "③" and "④". You can now enable/disable automatic S/W Time conversion.

## Enabling summertime/wintertime conversion

To enable the summertime/winter time conversion and set parameters, follow these steps:

1. Move the '>' cursor to 'On': Press ▲ or ▼
2. Confirm 'On': Press **OK**

The display shows:

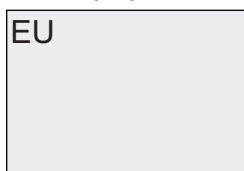

3. Select the desired conversion: Press ▲ or ▼

What is shown on the display ?:

- 'EU' represents the start and end of European summertime.
- 'UK' represents the start and end of summertime in the United Kingdom.
- 'US1' represents the start and end of daylight saving time (summertime) in the United States prior to 2007.
- 'US2' represents the start and end of daylight saving time (summertime) in the United States in 2007 and later years.
- 'AUS' represents the start and end of Australian summertime.
- 'AUS-TAS' represents the start and end of Australian/ Tasmanian summertime.
- 'NZ' represents the start and end of New Zealand summertime.
- .. : Here you can enter any month, day and time zone difference.

The table below lists the preset conversions:

	Start of summertime	End of summertime	Time zone difference $\Delta$
<b>EU</b>	Last Sunday in March: 02:00→03:00	Last Sunday in October: 03:00→02:00	60 Min.
<b>UK</b>	Last Sunday in March: 01:00→02:00	Last Sunday in October: 02:00→01:00	60 Min.
<b>US1</b>	First Sunday in April: 02:00→03:00	Last Sunday in October: 02:00→01:00	60 Min.
<b>US2</b>	Second Sunday in March: 02:00→03:00	First Sunday in November: 02:00→01:00	60 Min.
<b>AUS</b>	Last Sunday in October: 02:00→03:00	Last Sunday in March: 03:00→02:00	60 Min.
<b>AUS-TAS</b>	First Sunday in October: 02:00→03:00	Last Sunday in March: 03:00→02:00	60 Min.
<b>NZ</b>	First Sunday in October: 02:00→03:00	Third Sunday in March: 03:00→02:00	60 Min.
<b>..</b>	Customized month and day; 02:00→02:00 + Time zone difference	Customized month and day; Time zone difference: 03:00→03:00 - Time zone difference	User-defined (resolution in minutes)

**Note**

You can specify a time zone difference  $\Delta$  between 0 and 180 minutes.

The **US2** selection is only supported in LOGO! devices as of the series 0BA6.

Let us assume you want to enable European summertime/wintertime conversion:

1. Move the '>' cursor to 'EU': Press  $\blacktriangle$  or  $\blacktriangledown$
2. Confirm 'EU': Press **OK**

LOGO! shows the following display:



LOGO! indicates that European S/W Time conversion is enabled.

**User-defined parameters**

If none of the parameters/conversions apply to your country, you can customize these under menu item '. .'. To do so:

1. Confirm 'On' once again: Press **OK**
2. Move the '>' cursor to '. .': Press  $\blacktriangle$  or  $\blacktriangledown$
3. Confirm the menu item '. .': Press **OK**

The display shows:

Cursor / solid square

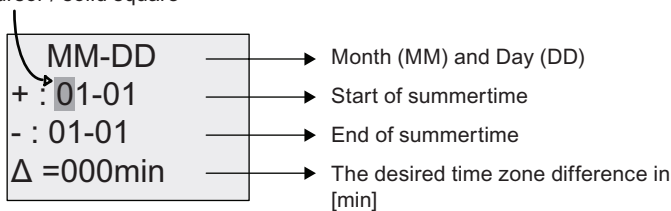

Let us assume you want to configure the following parameters: Start of summertime = 31st March, end of summertime = 1st November, time difference of 120 minutes.

This is how you can enter your data:

- Press  $\blacktriangleleft$  or  $\blacktriangleright$  to move the solid square/cursor.
- Press  $\blacktriangle$  and  $\blacktriangledown$  to change the value at the cursor position.

The display shows:

MM-DD	
+ : 03-31	→ 31. March
- : 11-01	→ 1. November
$\Delta$ = 120min	→ Time difference of 120 min

- Confirm all your entries with **OK**.

You have now customized the summertime/wintertime conversion. The LOGO! onboard display now shows:

>On
Off
S/W Time
On → ..

LOGO! indicates that summertime/wintertime conversion is enabled, and that user-defined parameters ('..') have been set.

---

**Note**

To disable summertime/wintertime conversion in this menu, you merely confirm 'Off' with **OK**.

---

---

**Note**

Summertime/wintertime conversion only functions when LOGO! is operating (in RUN or STOP status). It does not function when LOGO! is in buffered operation (Page 152).

---

### 3.7.15 Synchronization

Time synchronization between LOGO! and a connected communication module EIB/KNX (version 0AA1 upwards!) can be enabled/disabled

- in parameter assignment mode by means of the set menu ("Clock" menu item)
- in programming mode by means of the setup menu ("Clock" menu item).

When synchronization is enabled, LOGO! can receive the time-of-day from a communication module EIB/KNX (version 0AA1 upwards).

Whether synchronization is enabled or disabled, the time-of-day is always sent to the expansion modules at power-up, every hour (STOP mode or RUN mode), and when the time of day is changed (after a 'Set Clock' is executed or after a summertime/wintertime conversion).

---

#### Note

When using a LOGO! Base Module with digital or analog expansion modules, but without communication module EIB/KNX (version 0AA1 upwards), time synchronization **must not** be activated! You must check whether time synchronization is deactivated ('Sync' must be set to 'Off').

---

#### To enable/disable synchronization in programming mode:

1. Switch LOGO! to programming mode. LOGO! displays the main menu.

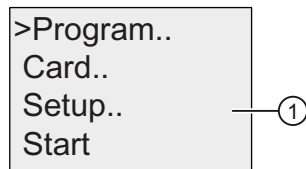

2. Select "①": Press ▲ or ▼
3. Confirm "①": Press **OK**

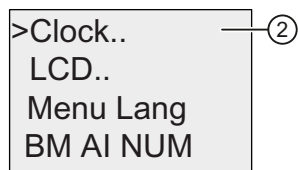

4. Move the '>' cursor to "②": Press ▲ or ▼
5. Confirm "②": Press **OK**

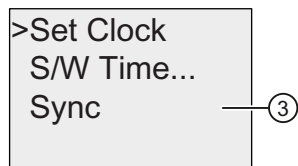

6. Move the '>' cursor to "③": Press ▲ or ▼
7. Apply "③": Press **OK**



LOGO! shows the following display:

```
>On      ⑤
Off
Sync:
Off      ④
```

The current setting of the automatic synchronization function is displayed on the bottom row. The default setting is "④"; that is, disabled.

**To enable/disable synchronization in parameter assignment mode:**

```
>Stop
Set Param
Set..    ⑥
Prg Name
```

```
>Clock.. ⑦
LCD..
Menu Lang
BM AI NUM
```

If you want to enable/disable automatic synchronization in parameter assignment mode, select "⑥" in the parameter assignment menu, then menus "⑦" and "③". You can now enable/disable automatic synchronization.

## Enabling synchronization

You want to enable synchronization:

1. Move the '>' cursor to "⑤": Press ▲ or ▼
2. Confirm "⑤": Press **OK**

LOGO! shows the following display:

```
>On
Off
Sync:
On
```

## 3.8 Configuring additional functions for LOGO! (0BA7 only)

If you are a LOGO! 0BA7 user, then after you have successfully created the second circuit program, you can configure additional functions, including the new functions for the 0BA7 device series, as described below.

### New menu commands

- Network
- Diagnostics

---

#### Note

These two menu commands are also available in the main menu of the ES7 version of the LOGO! TD.

---

### UDF and Data Log

You can configure the UDF and Data Log functions only from LOGO!Soft Comfort. After you have configured them in LOGO!Soft Comfort and downloaded them to the LOGO! 0BA7 device, you can then edit elements connected to these functions from the device:

- UDFs (User-Defined Functions)
- Data Log

### Network digital and analog I/O

You can configure the following connectors representing network digital or analog inputs/outputs only from LOGO!Soft Comfort:

- Network digital inputs
- Network analog inputs
- Network digital outputs
- Network analog outputs

---

#### Note

If your circuit program in a LOGO! 0BA7 device contains any network digital or analog inputs/outputs, you can only edit the "**Par**" parameter of function blocks. You can not edit any of the rest of the circuit program from the device.

---

### 3.8.1 Configuring network settings

A LOGO! 0BA7 device can establish network communication with other LOGO! 0BA7 devices, SIMATIC S7 PLCs, a SIMATIC HMI, or a PC with LOGO!Soft Comfort V7.0 (For more detailed information, refer to the Maximum LOGO! network setup (0BA7 only) (Page 32) topic). You can configure the LOGO! 0BA7 network only from LOGO!Soft Comfort V7.0. From LOGO! 0BA7, you can configure your LOGO!'s network settings including IP address, subnet mask and gateway.

#### Configuring the network settings

LOGO! 0BA7 provides a menu command for configuring network settings for your 0BA7 device.

1. Switch LOGO! to programming mode.

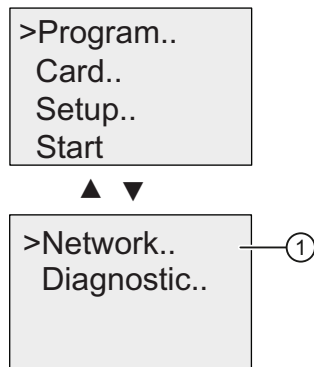

2. Press ▲ or ▼ to move the ">" cursor to "①".
3. Press **OK** to confirm "①".

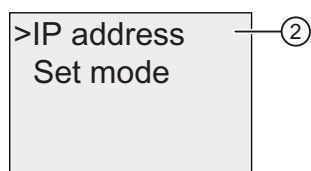

4. Press ▲ or ▼ to move the cursor to "②".
5. Press **OK** to confirm "②". LOGO! displays the following view:

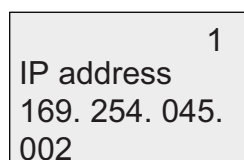

6. The display now shows the default IP address of your LOGO!. To change the setting, press **OK**. When the cursor appears in a solid square, press ◀ or ▶ to move the cursor to a position where you want to modify the number, then press ▲ or ▼ to increase or decrease the number.
7. Press **OK** to confirm your change.

8. Press ▲ or ▼ to step into the next screen form for subnet mask setting. The default subnet mask is as shown below. To change the setting, press **OK**. When the cursor appears in a solid square, press ◀ or ▶ to move the cursor to a position where you want to modify the number, then press ▲ or ▼ to increase or decrease the number. To confirm your change, press **OK**.

2
Subnet mask
255. 255. 000.
000

9. Press ▼. LOGO! displays the third screen form for gateway address setting. The default gateway is as shown below. To change the setting, press **OK**. When the cursor appears in a solid square, press ◀ or ▶ to move the cursor to a position where you want to modify the number, then press ▲ or ▼ to increase or decrease the number. To confirm your change, press **OK**.

3
Gateway
169. 254. 045.
001

### Transferring the circuit program to LOGO!Soft Comfort

After you have finished the network settings, you transfer the circuit program from LOGO! to LOGO!Soft Comfort using the transfer command LOGO!→PC in LOGO!Soft Comfort. For further information on uploading the circuit program to LOGO!Soft Comfort with this transfer menu command, refer to the Online Help for LOGO!Soft Comfort V7.0.

### 3.8.2 Configuring a UDF (User-Defined Function)

You can configure UDF (User-Defined Function) blocks only from LOGO!Soft Comfort.

A UDF block is a preconfigured circuit program that you create in LOGO!Soft Comfort. You can add it to an existing circuit program as you do with a function block. For a detailed description of the UDF configuration in LOGO!Soft Comfort, refer to the online help for LOGO!Soft Comfort V7.0.

If your circuit program in LOGO! contains a UDF block, you can configure elements connected to the block. For more information of configuration of UDF elements from LOGO! 0BA7, refer to the topic UDF (User-Defined Function) (0BA7 only) (Page 279).

### 3.8.3 Configuring the Data Log

You can configure the Data Log block only from LOGO!Soft Comfort.

You can configure a maximum of one Data Log for your circuit program using LOGO!Soft Comfort. The Data Log is used to record process measurement variables of the selected function blocks. For a detailed description of configuration of the Data Log function in LOGO!Soft Comfort, refer to the online help for LOGO!Soft Comfort V7.0.

If your circuit program in LOGO! contains the Data Log block, you can configure elements connected to the block. For more information of configuration of Data Log elements from LOGO! 0BA7, refer to the topic Data Log (0BA7 only) (Page 285).

### 3.8.4 Viewing network inputs/outputs

LOGO!Soft Comfort provides you with the following connectors representing network input/output blocks:

- Network digital inputs (identified with an **NI** in LOGO!)
- Network analog inputs (identified with an **NAI** in LOGO!)
- Network digital outputs (identified with an **NQ** in LOGO!)
- Network analog outputs (identified with an **NAQ** in LOGO!)

Network digital or analog inputs can connect with the inputs of function blocks. Network digital or analog outputs can connect with the outputs of function blocks.

If your circuit program contains a network digital/analog input, LOGO! can read a digital/analog value from another circuit program in a networked device. If your circuit program contains a network digital/analog output, LOGO! can write its digital/analog output value to another networked 0BA7 device in slave mode.

---

#### Note

You can only configure these network connectors for your circuit program from LOGO!Soft Comfort. If your circuit program in LOGO! contains a network connector, you can not make any edits to the circuit program from the LOGO! onboard display.

---

### Viewing network connectors in LOGO!

Consider a circuit program where a network digital input NI1 connects to the function block B5. B5 is connected to Q4. To view this network input, proceed as follows:

1. Switch LOGO! to programming mode. Press **OK** to step into the following display of your circuit program (example):

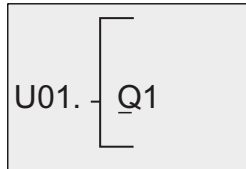

2. Press **▼** until LOGO! displays the following screen form:

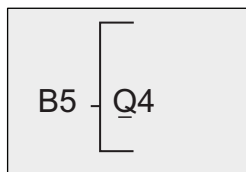

3. Press **OK** or **◀** to open B5. LOGO! shows the following display:

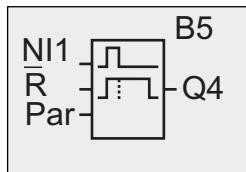

You can see that there is a network digital input NI1 connected at the first input of B5.

The following views are examples of network digital and analog outputs in LOGO!:

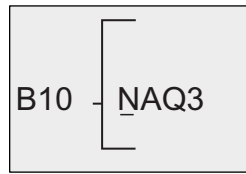
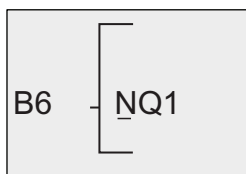

### Available network input/output blocks in LOGO!Soft Comfort

The following network I/O blocks are available for you to create your circuit program in LOGO!Soft Comfort:

- Network digital inputs: NI1 to NI64
- Network analog inputs: NAI1 to NAI32
- Network digital outputs: NQ1 to NQ64
- Network analog outputs: NAQ1 to NAQ16

### 3.8.5 Changing LOGO! to normal/slave mode

LOGO! 0BA7 provides a menu command for network communication settings. The section Configuring network settings (Page 119) showed you how to configure the network IP address, subnet mask and gateway for your LOGO!. This section shows you how to change LOGO!'s network communication mode.

A LOGO! 0BA7 device works in either **normal** or **slave** communication mode.

#### Normal mode versus slave mode

A LOGO! 0BA7 in normal mode supports client-server communication with SIMATIC S7 PLCs, a SIMATIC HMI or other 0BA7 devices across Ethernet. This LOGO! can additionally act as a master to communicate with one or more 0BA7 devices in slave mode.

A LOGO! in slave mode functions as a LOGO! expansion module. No circuit program is required for slave LOGO! devices. A master LOGO! can read one or more slave LOGO!'s digital/ analog input values and write its own digital/analog output values to these slaves. This helps LOGO! achieve network I/O expansion.

---

#### Note

A LOGO! in slave mode can also have its own expansion modules. It also supports a maximum of 24 digital inputs, 8 analog inputs, 16 digital outputs and 2 analog outputs.

---

#### Changing LOGO! from normal mode to slave mode

1. In the main menu, move the cursor to "①": Press ▲ or ▼

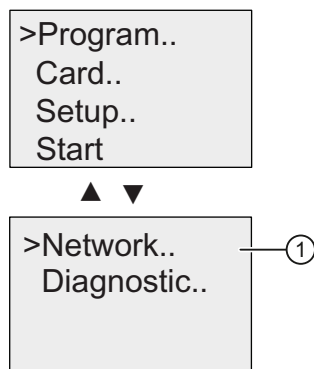

2. Confirm "①": Press **OK**

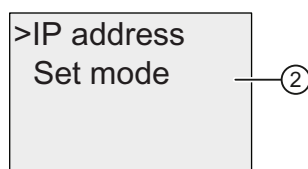

3. Move the cursor to "②": Press ▲ or ▼

4. Confirm "②": Press **OK**

LOGO! requires a password entry if one is assigned. If there is no password assigned on the LOGO!, LOGO! directly displays the view in Step 5.

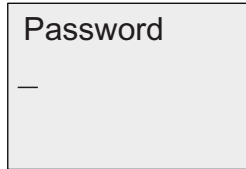

5. Move the cursor to ③: Press **▲** or **▼**

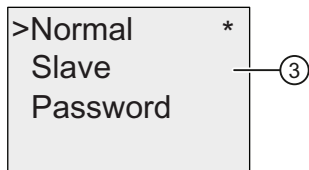

6. Confirm "③": Press **OK**

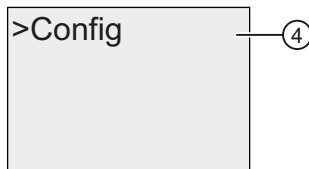

7. Confirm "④": Press **OK**

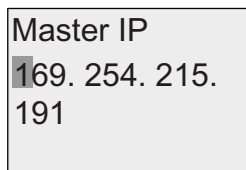

8. In this view, you enter the IP address of the LOGO! that you want to configure to be the master of your slave LOGO!. Press **◀** or **▶** to move the square cursor through the numbers. Press **▲** or **▼** to change the number.

9. Confirm the setting: Press **OK**

You have now successfully changed LOGO! from normal mode to slave mode. LOGO! restarts automatically and then displays the main menu. Stepping into the following view, you can see that your LOGO! is now in slave mode:

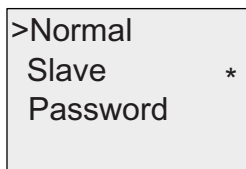

---

**Note**

When LOGO! is in slave mode, you can not edit the circuit program from the slave LOGO!.

The menu command ② is not available in parameter assignment mode.

---



## Changing LOGO! from slave mode to normal mode

LOGO! is now in the following view:

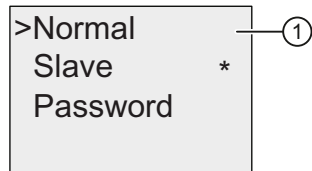

1. Move the cursor to "①": Press ▲ or ▼
2. Confirm "①": Press **OK**

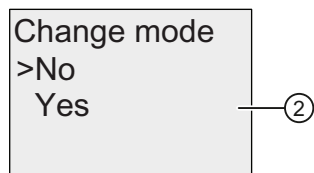

3. Move the cursor to "②": Press ▲ or ▼
4. Confirm "②": Press **OK**

You have now successfully changed the LOGO! from slave mode to normal mode. LOGO! restarts automatically and then displays the main menu.

## Assigning a password from the LOGO!

1. Repeat steps 1 to 5 as described earlier in the topic "**Changing LOGO! from normal mode to slave mode**". LOGO! shows the following display:

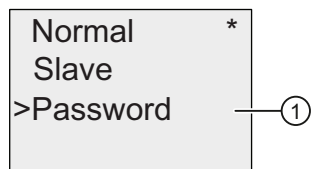

2. Move the cursor to "①": Press ▲ or ▼
3. Confirm "①": Press **OK**

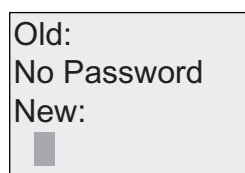

4. Enter a password. The procedure is the same as for entering a password for the circuit program. (see the topic Password for circuit program protection (Page 91)).

### Changing the password from the LOGO!

After you enter the password assigned, LOGO! shows the following display:

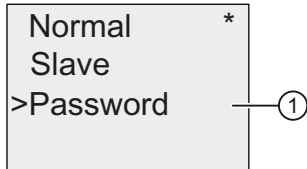

1. Move the cursor to "①": Press ▲ or ▼
2. Confirm "①": Press **OK**

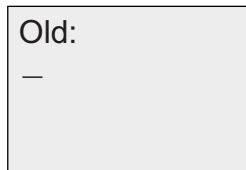

3. Enter the password assigned (for example: AA) and press **OK**. The display now shows:

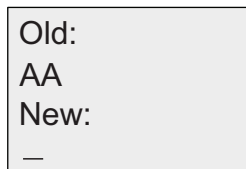

4. Enter a new password (for example: ZZ) and press **OK** to confirm your new password.

## Deactivating the password from the LOGO!

To deactivate the password when LOGO! is in the following view, follow these steps:

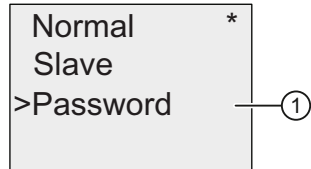

1. Move the cursor to "①": Press ▲ or ▼
2. Confirm "①": Press **OK**

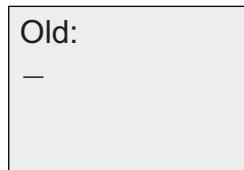

3. Enter the current password (for example: ZZ) and press **OK**. The display now shows:

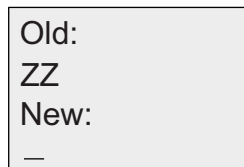

4. Clear the password by leaving the input field blank. Press **OK** to confirm.

The password is now cleared.

### 3.8.6 Diagnosing errors from LOGO!

LOGO! 0BA7 supports error diagnostics. From LOGO!, you can view basic errors including SD card read/write errors, network communication errors, and so forth. You can clear individual error messages or all error messages. You can also view the firmware version of your current LOGO!.

#### Viewing the firmware version of LOGO!

To view the firmware version, following these steps:

1. In the main menu, move the cursor to "①": Press ▲ or ▼

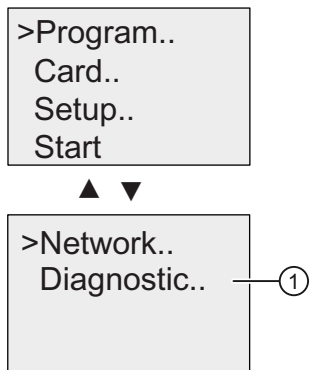

2. Confirm "①": Press **OK**

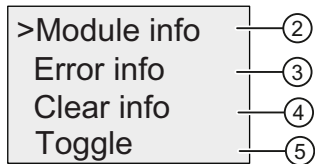

3. LOGO! shows you the diagnostic menu. Move the cursor to "②": Press ▲ or ▼
4. Confirm "②": Press **OK**

LOGO! shows you the firmware version of the module, for example as shown below:

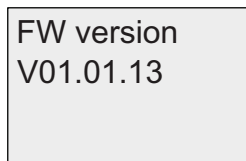

To return to the diagnostic menu, press **ESC**.

#### Viewing error information

1. In the diagnostic menu shown above, move the cursor to "③": Press ▲ or ▼
2. Confirm "③": Press **OK**. LOGO! displays all errors detected. Press **ESC** to return to the previous view.

## Clearing error information

LOGO! 0BA7 can provide the following error messages:

- SD card read/write error
- SD card is write-protected
- EM (expansion module) bus error
- Network error

To clear a specific error or all errors, proceed as follows:

1. In the diagnostic menu shown above, move the cursor to "④": Press ▲ or ▼
2. Confirm "④": Press **OK**

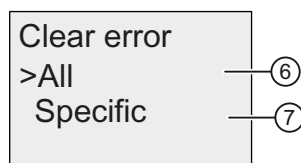

3. If you want to clear all error messages, move the cursor to "⑥": Press ▲ or ▼
4. Confirm "⑥": Press **OK**

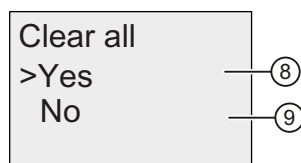

5. Move the cursor to "⑧": Press ▲ or ▼
6. Confirm "⑧": Press **OK**. LOGO! clears all error messages and returns to the view in step 2. (If you do not want to clear all error messages, select "⑨" and press **OK** to confirm.)
7. If you want to clear a specific error message, move the cursor to "⑦": Press ▲ or ▼
8. Confirm "⑦": Press **OK**. LOGO! displays individual errors. Press **OK** to clear a specific error.

## Toggling an error alert

You can enable/disable an error alert by proceeding as follows:

1. In the diagnostic menu shown earlier, move the cursor to "⑤": Press ▲ or ▼
2. Confirm "⑤": Press **OK**

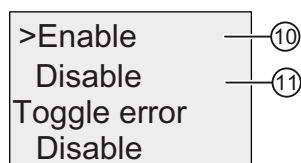

3. The bottom line shows you the current setting. To change the setting: Press ▲ or ▼
4. Confirm your selection: Press **OK**. LOGO! returns to the previous view.

If you enabled the error alert, when an error occurs, the LOGO! display will flash reminding you that LOGO! detects an error. You can go to the diagnostic menu to view the error.

### 3.9 Memory space and circuit program size

The size of a circuit program in LOGO! is limited by the memory space (memory used by the blocks).

#### Memory areas

- **Program memory:**  
LOGO! allows only a limited number of blocks in your circuit program.  
The second limitation is based on the maximum number of bytes a circuit program may contain. The total number of bytes used can be determined by adding up the number of bytes used for the relevant function blocks.
- **Retentive memory (Rem):**  
In this area, LOGO! stores values which need to be retentive; for example, the hours counter value. Blocks with optional retentivity use this memory area only if this function is actually enabled.

---

#### Note

LOGO! supports a maximum of one million write cycles. LOGO! counts every power-off, program downloading from LOGO!Soft Comfort to LOGO!, program creation from LOGO!, or menu setting as one cycle.

---

#### Resources available in LOGO!

A circuit program in LOGO! can occupy the following maximum resources:

LOGO! device series	Bytes	Blocks	REM
LOGO! 0BA6	3800	200	250
LOGO! 0BA7	8400	400	250

LOGO! monitors memory utilization, and offers only those functions from the lists for which it can actually provide sufficient memory space.

**Memory requirements (0BA6)**

The table below shows an overview of the memory requirements for the basic and special function blocks in LOGO! 0BA6:

Function	Program memory	Rem memory*
<b>Basic functions</b>		
AND	12	-
AND with edge evaluation	12	-
NAND (not AND)	12	-
NAND with edge evaluation	12	-
OR	12	-
NOR (not OR)	12	-
XOR (exclusive OR)	8	-
NOT (Negation)	4	-
<b>Special functions</b>		
Timers		
On-delay	8	3
Off-delay	12	3
On-/Off-delay	12	3
Retentive on-delay	12	3
Wiping relay (pulse output)	8	3
Edge triggered wiping relay	16	4
Asynchronous pulse generator	12	3
Random generator	12	-
Stairway lighting switch	12	3
Multiple function switch	16	3
Weekly timer	20	-
Yearly timer	12	-
Counters		
Up/down counter	28	5
Hours counter	28	9
Threshold trigger	16	-
Analog		
Analog threshold trigger	16	-
Analog differential trigger	16	-
Analog comparator	24	-
Analog watchdog	20	-
Analog amplifier	12	-
Pulse Width Modulator (PWM)	24	-
Mathematic instruction	20	-
Mathematic instruction error detection	12	1

3.9 Memory space and circuit program size

Function	Program memory	Rem memory*
Analog multiplexer	20	-
Analog ramp	36	-
PI controller	40	2
Others		
Latching relay	8	1
Pulse relay	12	1
Message texts	8	-
Softkey	8	2
Shift register	12	1

\*: Bytes in the Rem memory area if retentivity is enabled.

**Memory requirements (0BA7)**

The table below shows an overview of the memory requirements for the basic and special function blocks in LOGO! 0BA7:

Function	Program memory	Rem memory*
<b>Basic functions</b>		
AND	12	-
AND with edge evaluation	12	-
NAND (not AND)	12	-
NAND with edge evaluation	12	-
OR	12	-
NOR (not OR)	12	-
XOR (exclusive OR)	8	-
NOT (Negation)	8	-
<b>Special functions</b>		
Timers		
On-delay	12	3
Off-delay	16	3
On-/Off-delay	16	3
Retentive on-delay	16	3
Wiping relay (pulse output)	12	3
Edge triggered wiping relay	20	4
Asynchronous pulse generator	16	3
Random generator	16	-
Stairway lighting switch	16	3
Multiple function switch	20	3
Weekly timer	22	-



Function	Program memory	Rem memory*
Yearly timer	12	-
Astronomical clock	20	-
Stopwatch	28	17
Counters		
Up/down counter	32	5
Hours counter	36	9
Threshold trigger	16	-
Analog		
Analog threshold trigger	20	-
Analog differential trigger	20	-
Analog comparator	24	-
Analog watchdog	24	-
Analog amplifier	12	-
Pulse Width Modulator (PWM)	30	-
Mathematic instruction	24	-
Mathematic instruction error detection	16	1
Analog multiplexer	20	-
Analog ramp	40	-
PI controller	44	2
Analog filter	16	-
Max/Min	20	6
Average value	32	16
Others		
Latching relay	12	1
Pulse relay	12	1
Message texts	12	-
Softkey	12	2
Shift register	16	1

\*: Bytes in the Rem memory area if retentivity is enabled.

#### Note

Since a UDF block is a preconfigured circuit program that you create from LOGO!Soft Comfort V7.0 for your LOGO! 0BA7 device, the memory size (program memory and Rem memory) of a UDF block depends upon the size of the function blocks contained in the UDF.

#### Utilization of memory areas

The system indicates that there is insufficient memory space by not allowing you to add a block to your circuit program. LOGO! offers you only the blocks for which it can provide sufficient memory space. If LOGO! memory space is insufficient to hold any additional blocks, the system will deny access to the block list.

If memory space is fully occupied, optimize your circuit program or install another LOGO!.

**Calculating memory requirements**

When calculating the memory requirements of a circuit, you must always take into account all individual areas of memory.

**Example:**

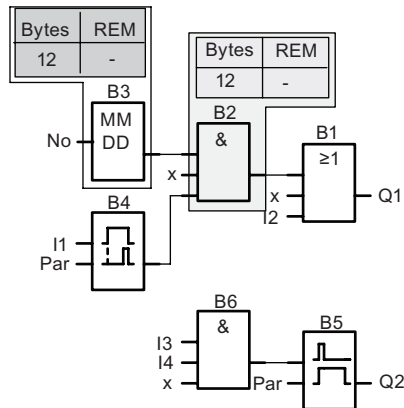

The sample circuit program contains:

Block no.	Function	Memory area			
		Bytes (0BA6)	Bytes (0BA7)	Blocks	REM
B1	OR	12	12	1	-
B2	AND	12	12	1	-
B3	Yearly timer	12	12	1	-
B4	On-delay*	8	12	1	3
B5	Stairway lighting switch	12	16	1	3
B6	AND	12	12	1	-
	Resources used by the circuit program	68	76	6	6
	Memory space limits in LOGO! 0BA6	3800		200	250
	<b>Still available in LOGO! 0BA6</b>	<b>3732</b>		<b>194</b>	<b>244</b>
	Memory space limits in LOGO! 0BA7		8400	400	250
	<b>Still available in LOGO! 0BA7</b>		<b>8324</b>	<b>394</b>	<b>244</b>

\*: Configured with retentivity.

This means that this circuit program fits in LOGO!.

## Indication of available memory space

LOGO! shows you the amount of free memory space.

Proceed as follows:

1. Switch LOGO! to programming mode  
(as a reminder, refer to the topic "The four golden rules for operating LOGO! (Page 79)".
2. Select "①": Press ▲ or ▼

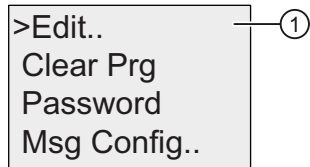

```

>Edit..
Clear Prg
Password
Msg Config..
  
```

3. Confirm "①": Press **OK**

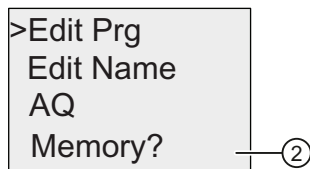

```

>Edit Prg
Edit Name
AQ
Memory?
  
```

4. Select "②": Press ▲ or ▼
5. Confirm "②": Press **OK**

The display in LOGO! 0BA6 now shows:

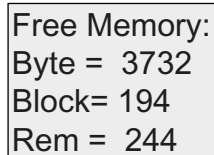

```

Free Memory:
Byte = 3732
Block = 194
Rem = 244
  
```

The display in LOGO! 0BA7 now shows:

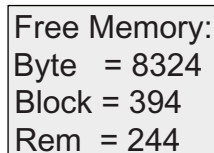

```

Free Memory:
Byte = 8324
Block = 394
Rem = 244
  
```



## LOGO! functions

LOGO! provides you with various elements in programming mode, which are organized in the following lists:

- ↓Co: Connector list (Connector) (Page 138)
- ↓GF: List of the basic functions AND, OR, ... (Page 142)
- ↓SF: List of the special functions (Page 156)
- ↓BN: List of reusable blocks configured in the circuit program

LOGO! 0BA7 can additionally provide you with the following elements in programming mode, if you have previously configured them in your circuit program using LOGO!Soft Comfort:

- ↓UDF: List of user-defined function blocks configured in the circuit program
- L: A Data Log function block configured in the circuit program

### List contents

All lists show the elements available in LOGO!. Usually, this includes *all* connectors, basic functions, and special functions. The ↓BN and ↓UDF lists show all the blocks that you have created in LOGO!.

### If not all is shown

LOGO! does *not* show all elements if:

- No further blocks may be added.  
This is either an indication of insufficient memory space or that the maximum number of blocks has been reached.
- A specific block's memory space requirement (Page 130) would exceed the space available in LOGO!
- You have not previously configured them (network digital and analog inputs/outputs, UDF blocks, and the Data Log block) in the circuit program in LOGO!Soft Comfort and downloaded the program to LOGO!.

## 4.1 Constants and connectors - Co

Constants and connectors (Co) represent inputs, outputs, flags, constant voltage levels (constants), and network digital and analog inputs/outputs (if 0BA7).

### Inputs:

#### 1) Digital inputs

Digital inputs are identified with an **I**. The number of the digital inputs (I1, I2, ...) corresponds to the number of the input connectors of the LOGO! Base Module and of the connected digital modules, in the order of their installation. The fast digital inputs I3, I4, I5, and I6 of the LOGO! versions LOGO! 24/24o, LOGO! 24C/24Co, LOGO! 12/24RC, LOGO! 12/24RCo and LOGO! 12/24RCE can be used as fast counters.

#### 2) Analog inputs

The LOGO! versions LOGO! 24, LOGO! 24o, LOGO! 24C, LOGO! 24Co, LOGO! 12/24RC, LOGO! 12/24RCo and LOGO! 12/24RCE are equipped with the inputs I1, I2, I7 and I8, which can also be programmed for use as **AI3, AI4, AI1** and **AI2** inputs. As described in topic "Setting the number of AIs in the LOGO! Basic (Page 299)", you can configure these modules to use either two analog inputs (AI1 and AI2), or all four. Signals at the I1, I2, I7 and I8 inputs are interpreted as digital values, and those at the AI3, AI4, AI1 and AI2 inputs are interpreted as analog values. Note that AI3 corresponds to I1 and AI4 corresponds to I2. This numbering preserves the previous correspondence of AI1 to I7 and AI2 to I8 that was available with the 0BA5 series. The inputs of a connected analog module are numbered according to the already existing analog inputs. See topic "Maximum setup with expansion and communication modules (Page 34)" for example setups. In programming mode, when you select the input signal of a special function that takes an analog input, LOGO! offers the analog inputs AI1 to AI8, analog flags AM1 to AM6 (0BA6) or AM1 to AM16 (0BA7), analog outputs AQ1 and AQ2, and the block numbers of functions with analog outputs.

### Outputs:

#### 1) Digital outputs

Digital outputs are identified by the character **Q**. The output numbers (Q1, Q2, ... Q16) correspond with the numbers of the output connectors at the LOGO! Base Module and with those of the expansion modules, in their order of installation. See the following figure.

There are also 16 blank outputs available in LOGO! 0BA6 or 64 blank outputs available in LOGO! 0BA7. These are identified with an **x** and cannot be reused in a circuit program (in contrast to flags, for example). The list shows all programmed blank outputs, and one blank output which is not yet configured. A blank output, for example, is useful for the special function "Message texts" (Page 231), if only the message text is of significance to a circuit program.

## 2) Analog outputs

Analog outputs are identified by the letters **AQ**. Two analog outputs are available, namely AQ1 and AQ2. An analog output can only be connected with the analog input of a function, an analog flag AM or an analog output connector.

The following figure shows an example LOGO! configuration and the numbering of the inputs and outputs for the circuit program.

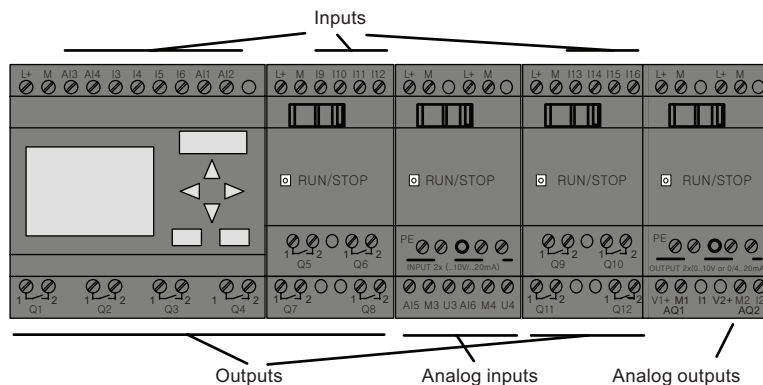

## Flag blocks

Flag blocks are identified by the letters **M** or **AM**. These are virtual outputs, which output the value of their inputs. LOGO! 0BA6 provides 27 digital flags M1 to M27 and 6 analog flags AM1 to AM6. LOGO! 0BA7 provides 27 digital flags M1 to M27 and 16 analog flags AM1 to AM16.

## Startup flag

Flag M8 is set in the first cycle of the circuit program and can thus be used in your circuit program as a startup flag. This signal is automatically reset after the circuit program has completed its first cycle.

The M8 flag can be used in all further cycles for setting, deletion and evaluation procedures in the same way as other flags.

## Backlight flags M25 and M26

The M25 flag controls the backlight of the LOGO! onboard display. The M26 flag controls the backlight of the LOGO! TD.

**Note:** The backlight lifetime of the LOGO! TD is 20,000 hours.

### Message text character set flag M27

The M27 flag selects between the two character sets that LOGO! uses to display message texts. State 0 corresponds to Character Set 1, and state 1 corresponds to Character Set 2. If M27=0 (low), only message texts configured for Character Set 1 will display; If M27=1 (high), only message texts configured for Character Set 2 will display. If you do not include M27 in the circuit program, message texts display in the character set that you selected from either the Msg Config menu or from LOGO!Soft Comfort.

---

#### Note

The output of the flag always carries the signal of the previous program cycle. This value does not change within the same program cycle.

---

### Shift register bits

LOGO! provides the shift register bits S1 to S8 (if 0BA6) or S1.1 to S4.8 (if 0BA7), which are assigned the read-only attribute in the circuit program. The content of shift register bits can only be modified by means of the "Shift register" (Page 245) special function.

### Cursor keys

Up to four cursor keys are available to you, namely C ▲, C ►, C ▼ and C ◀ ("C" = "Cursor"). Cursor keys are programmed for the circuit program in the same way as other inputs. You can set the cursor keys in the corresponding display while the system is in RUN (Page 97) , and in an active message text (ESC + Key). Cursor keys can save switches and inputs, and allow operator control of the circuit program. Cursor key inputs from the LOGO! TD are identical to cursor key inputs from the LOGO! Base Module.

### LOGO! TD function keys

The LOGO! TD has four function keys that you can use in your circuit program. You program these keys in the same way as other inputs. Like the cursor keys, you can press these keys when LOGO! is in RUN mode to affect the behavior of the circuit program, and to save switches and inputs. They are identified as F1, F2, F3, and F4.

### Levels

Voltage levels are designated **hi** and **lo**. A constant "1" = hi or "0" = lo status at the block can be set by means of a permanent voltage level or constant value hi or lo.

### Open connectors

Unused block connectors can be identified with an **x**.



**Network inputs/outputs (available only in 0BA7 if configured from LOGO!Soft Comfort)**

You can configure the following network inputs/outputs only from LOGO!Soft Comfort. If the circuit program in LOGO! contains a network digital/analog I/O, you can not edit any of the rest of the circuit program except for the Par parameter. To edit the rest of the program, you must upload the program to LOGO!Soft Comfort and then edit from LOGO!Soft Comfort.

**1) Network digital inputs**

Network digital inputs are identified with an **NI**. There are 64 digital network digital inputs NI1 to NI64 available for configuration in the circuit program from LOGO!Soft Comfort.

**2) Network analog inputs**

Network analog inputs are identified with an **NAI**. There are 32 network analog inputs NAI1 to NAI32 available for configuration in the circuit program from LOGO!Soft Comfort.

**3) Network digital outputs**

Network digital outputs are identified with an **NQ**. There are 64 network digital outputs NQ1 to NQ64 available for configuration in the circuit program from LOGO!Soft Comfort.

**4) Network analog outputs**

Network analog outputs are identified with an **NAQ**. There are 16 network analog outputs NAQ1 to NAQ16 available for configuration in the circuit program from LOGO!Soft Comfort.

## 4.2 Basic functions list - GF

Basic functions represent simple logical elements of Boolean algebra.

You can invert the inputs of individual basic functions, that is, the circuit program inverts a logical "1" at a relevant input to a logical "0"; if "0" is set at the input, the program sets a logical "1". See the programming example at Circuit program input (Page 86).

The GF list contains the basic function blocks you can use for your circuit program. The following basic functions are available:

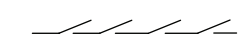
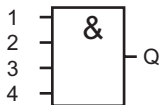
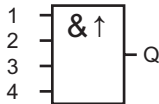
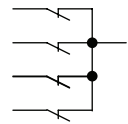
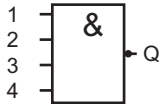
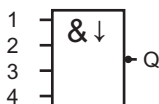
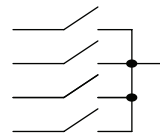
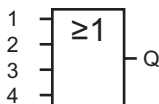
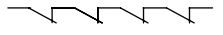
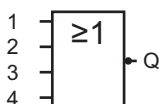
View in the circuit diagram	View in LOGO!	Name of the basic function
 <p>Series circuit make contact</p>		AND (Page 143)
		AND with edge evaluation (Page 144)
 <p>Parallel circuit with break contacts</p>		NAND (Page 145) (not AND)
		NAND with edge evaluation (Page 146)
 <p>Parallel circuit with make contacts</p>		OR (Page 147)
 <p>Series circuit with break contacts</p>		NOR (Page 148) (not OR)

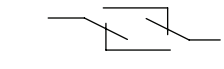
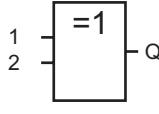
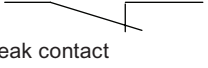
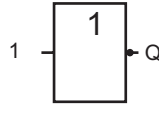
View in the circuit diagram	View in LOGO!	Name of the basic function
 Double changeover contact		XOR (Page 149) (exclusive OR)
 Break contact		NOT (Page 149) (negation, inverter)

### 4.2.1 AND

Circuit diagram of a series circuit with several make contacts:

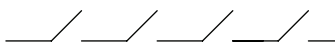

Symbol in LOGO!:

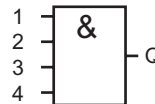

The output of the AND is only 1 if **all** inputs are 1, i.e. all contacts are closed.

At an unused block input (x):  $x = 1$ .

#### AND function logic table

1	2	3	4	Q
0	0	0	0	0
0	0	0	1	0
0	0	1	0	0
0	0	1	1	0
0	1	0	0	0
0	1	0	1	0
0	1	1	0	0
0	1	1	1	0
1	0	0	0	0
1	0	0	1	0
1	0	1	0	0
1	0	1	1	0
1	1	0	0	0
1	1	0	1	0
1	1	1	0	0
1	1	1	1	1

### 4.2.2 AND with edge evaluation

Symbol in LOGO!:

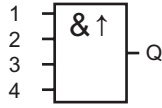

The output of an edge triggered AND is only 1 if **all** inputs are 1 and if **at least one** input was low in the previous cycle.

At an unused block input (x):  $x = 1$ .

#### Timing diagram for the AND with edge evaluation

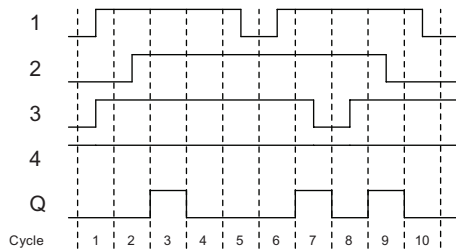

### 4.2.3 NAND (not AND)

Parallel circuit with multiple break contacts in the circuit diagram:

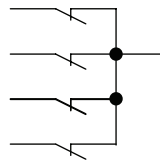

Symbol in LOGO!:

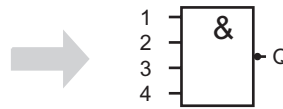

The output of the NAND is only 0 if the status at **all** inputs is 1, i.e. the contacts are closed.

At an unused block input (x):  $x = 1$ .

#### NAND function logic table

1	2	3	4	Q
0	0	0	0	1
0	0	0	1	1
0	0	1	0	1
0	0	1	1	1
0	1	0	0	1
0	1	0	1	1
0	1	1	0	1
0	1	1	1	1
1	0	0	0	1
1	0	0	1	1
1	0	1	0	1
1	0	1	1	1
1	1	0	0	1
1	1	0	1	1
1	1	1	0	1
1	1	1	1	0

### 4.2.4 NAND with edge evaluation

Symbol in LOGO!:

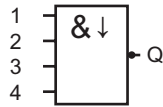

The output status of the NAND with edge evaluation is only 1 if **at least one** input is 0 and if **all** inputs were 1 in the previous cycle.

At an unused block input (x): x = 1.

#### Timing diagram for the NAND with edge evaluation

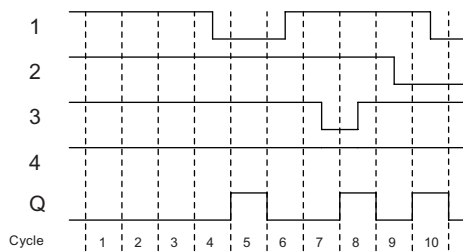

## 4.2.5 OR

Circuit diagram of a parallel circuit with several make contacts:

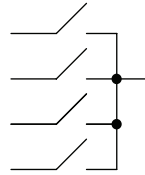

Symbol in LOGO!:

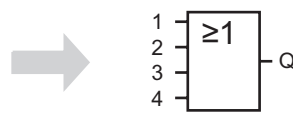

The output status of the OR element is only 1 if **at least one** input is 1, i.e. at least one of the contacts is closed.

At an unused block input (x):  $x = 0$ .

### OR function logic table

1	2	3	4	Q
0	0	0	0	0
0	0	0	1	1
0	0	1	0	1
0	0	1	1	1
0	1	0	0	1
0	1	0	1	1
0	1	1	0	1
0	1	1	1	1
1	0	0	0	1
1	0	0	1	1
1	0	1	0	1
1	0	1	1	1
1	1	0	0	1
1	1	0	1	1
1	1	1	0	1
1	1	1	1	1

### 4.2.6 NOR (not OR)

Circuit diagram of a series circuit with several break contacts:

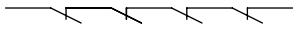

Symbol in LOGO!:

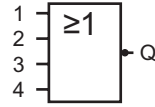

The output status of the NOR is only 1 if **all** inputs are 0, i.e. if switched off. The NOR output is set to 0 when one of the inputs is switched on (logical 1 status).

At an unused block input (x): x = 0.

#### NOR function logic table

1	2	3	4	Q
0	0	0	0	1
0	0	0	1	0
0	0	1	0	0
0	0	1	1	0
0	1	0	0	0
0	1	0	1	0
0	1	1	0	0
0	1	1	1	0
1	0	0	0	0
1	0	0	1	0
1	0	1	0	0
1	0	1	1	0
1	1	0	0	0
1	1	0	1	0
1	1	1	0	0
1	1	1	1	0



### 4.2.7 XOR (exclusive OR)

The XOR in a circuit diagram, shown as series circuit with 2 changeover contacts:

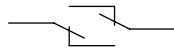

Symbol in LOGO!:

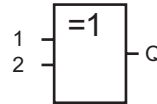

The output status of the XOR is 1 if the inputs are **not equivalent**.

At an unused block input (x): x = 0.

#### XOR function logic table

1	2	Q
0	0	0
0	1	1
1	0	1
1	1	0

### 4.2.8 NOT (Negation, Inverter)

A break contact in the circuit diagram:

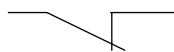

Symbol in LOGO!:

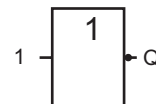

The output status is 1 if the input is 0. The NOT block inverts the input status.

Advantage of the NOT block, for example: LOGO! does not require break contacts. You simply use a make contact and the NOT block to convert these into a break contact.

#### NOT function logic table

1	Q
0	1
1	0

## 4.3 Special Functions

Because of their different input designation, you can see right away that there is a difference between the special functions and basic functions. Special functions (SFs) contain timer functions, retentive functions and various parameter assignment options, which allow you to adapt the circuit program to suit your own requirements.

This section provides you with a brief overview of input designations and with some particular background information on SFs (Page 156).

### 4.3.1 Designation of the inputs

#### Logical inputs

Here, you will find the description of the connectors you can use to create a logical link to other blocks or to the inputs of the LOGO! unit.

- **S (Set):**  
A signal at input S sets the output to logical "1".
- **R (Reset):**  
The reset input R takes priority over all other inputs and resets the outputs.
- **Trg (Trigger):**  
This input is used to trigger the start of a function.
- **Cnt (Count):**  
This input is used for counting pulses.
- **Fre (Frequency):**  
Frequency signals to be evaluated are applied to this input.
- **Dir (Direction):**  
This input determines the direction, + or -.
- **En (Enable):**  
This input enables a block function. When this input is "0", other signals to the block will be ignored.
- **Inv (Invert):**  
A signal at this input inverts the output signal of the block.
- **Ral (Reset all):**  
All internal values are reset.

**The following connector is available only in the device series 0BA7:**

- **Lap** (for the stopwatch function)  
A signal at this input pauses the stopwatch.

---

#### Note

Unused logical inputs of special functions default to logical "0".

---

### Connector X at SF inputs

SF inputs connected to connector x are set low. That is, the inputs carry a 'lo' signal.

### Parameter inputs

At some of the inputs you do not apply any signals. You configure the relevant block values instead. Examples:

- **Par (Parameter):**  
This input will not be connected. Here, you set the relevant block parameters (times, on/off thresholds etc.).
- **No (Cam):**  
This input will not be connected. Here, you configure the time patterns.
- **P (Priority):**  
This is an open input. Here, you define priorities and specify whether a message is to be acknowledged in RUN.

## 4.3.2 Time response

### Parameter T

At some of the SFs it is possible to configure a time value T. When you preset this time, note that your input values are based on the timebase set:

Timebase	__ : __
s (seconds)	seconds : <sup>1</sup> / <sub>100</sub> seconds
m (minutes)	minutes : seconds
h (hours)	hours : minutes

B1 +  
T =04:10h

Setting a time T of 250 minutes:  
Unit in hours h:  
04:00 hours      240 minutes  
00:10 hours      +10 minutes  
=                    250

#### Exception:

The LOGO! 0BA7-specific stopwatch function provides an additional timebase - 10 ms. For a detailed description, see the topic Stopwatch (0BA7 only) (Page 198).

### Accuracy of T

Because of slight tolerances in the characteristics of electronic components, the set time T can deviate. You can find a detailed description of such deviations in the "On-delay" topic (Page 160).

### Accuracy of the timer (weekly/yearly timer)

To prevent timing inaccuracy of the real-time clock in C versions caused by this deviation, the timer value is continuously compared with a high-precision timebase and corrected. The resultant maximum timing inaccuracy is  $\pm 2$  s/day.

### 4.3.3 Backup of the real-time clock

Because the internal real-time clock of a LOGO! is backed up, it continues operation after a power failure. The ambient temperature influences the backup time. At an ambient temperature of 25°C, the typical backup time of a LOGO! 0BA6 is 80 hours and the typical backup time of a LOGO! 0BA7 is 20 days.

If there is a power outage of a LOGO! for more than 80 hours (if 0BA6) or 20 days (if 0BA7), the internal clock responds, dependent on the equipment series, as shown below:

- Equipment series 0BA0:  
On restarting, the clock is set to "Sunday 00:00 1 January". The time starts to run. Due to this, the system processes the time switches, which trigger actions if necessary.
- Equipment series 0BA1 to 0BA6:  
On restarting, the clock is set to "Sunday 00:00 1 January". The time is stopped and flashes. LOGO! is back in the status that it was in before the power outage. In RUN mode, the system processes the counters that were parameterized with the time above. The clock is, however, still stopped.
- Equipment series 0BA6:  
If you are using the optional LOGO! Battery card, or combined LOGO! Memory/Battery card, LOGO! can retain the clock time for up to two years. These cards are available for equipment series 0BA6.
- Equipment series 0BA7  
On restarting, the clock is set to "Sa 00 00 2011-01-01". The time is stopped and flashes. LOGO! is back in the status that it was in before the power outage. In RUN mode, the system processes the counters that were parameterized with the time above. The clock is, however, still stopped.

#### 4.3.4 Retentivity

The switching states, counter and time values of many SFs (see the "Special functions list - SF (Page 156)" topic) can be set retentive. This means that current data values are retained after a power failure, and that the block resumes operation at the break point. The timer is not reset, but resumes operation until the time-to-go has expired, for example.

To enable this response, however, the relevant functions must be set retentive. Two options are available:

R: The data is retained.

/: Current data is not retained (default). See the section in topic "Second circuit program (Page 100)" on enabling and disabling retentivity.

The hours counter, weekly timer, yearly timer and PI controller are always retentive.

#### 4.3.5 Parameter protection

In the parameter protection settings, you can determine whether or not the parameters can be displayed and edited in LOGO! parameter assignment mode. Two options are available:

+: The parameter attribute permits read/write access in parameter assignment mode (default).

-: The parameter settings are read-/write-protected in parameter assignment mode, and can be edited only in programming mode. See the parameter protection mode example in the Second circuit program (Page 100).

---

##### Note

Parameter protection covers only the "Set Param" window. If you embed variables of protected special functions in a message text, the variables are still editable from the message text. To protect these variables, you must also activate the protection of the message text.

---

### 4.3.6 Calculating the gain and offset of analog values

A sensor is connected to the analog input and converts a process variable into an electrical signal. This value of signal lies within the typical range of this sensor.

LOGO! always converts the electrical signals at the analog input into digital values from 0 to 1000.

A voltage of 0 to 10 V at input AI is transformed internally into a range of values from 0 to 1000. An input voltage exceeding 10 V is shown as internal value 1000.

Because you cannot always process the range of values from 0 to 1000 as predetermined by LOGO!, you can multiply the digital values by a gain factor and then shift the zero of the range of values (offset). This allows you to output an analog value to the LOGO! onboard display, which is proportional to the actual process variable.

Parameter	Minimum	Maximum
Input voltage (in V)	0	≥ 10
Internal value	0	1000
Gain	-10.00	+10.00
Offset	-10000	+10000

#### Mathematical rule

$$\text{Actual value } Ax = (\text{internal value at input } Ax \cdot \text{gain}) + \text{offset}$$

#### Gain and offset calculation

The gain and offset is calculated based on the relevant high and low values of the function.

Example 1:

The available thermocouples have the following technical data: -30 to +70 °C, 0 to 10 V DC (i.e. 0 to 1000 in LOGO!).

$$\text{Actual value} = (\text{internal value} \cdot \text{gain}) + \text{offset, thus}$$

$$-30 = (0 \cdot A) + B, \text{ i.e. offset } B = -30$$

$$+70 = (1000 \cdot A) - 30, \text{ i.e. gain } A = 0.1$$

Example 2:

A pressure sensor converts a pressure of 1000 mbar into a voltage of 0 V, and a pressure of 5000 mbar into a voltage of 10 V.

$$\text{Actual value} = (\text{internal value} \cdot \text{gain}) + \text{offset, thus}$$

$$1000 = (0 \cdot A) + B, \text{ i.e. offset } B = 1000$$

$$5000 = (1000 \cdot A) + 1000, \text{ i.e. gain } A = 4$$

### Example of analog values

Process variable	Voltage (V)	Internal value	Gain	Offset	Value shown (Ax)
-30 °C	0	0	0.1	-30	-30
0 °C	3	300	0.1	-30	0
+70 °C	10	1000	0.1	-30	70
1000 mbar	0	0	4	1000	1000
3700 mbar	6.75	675	4	1000	3700
5000 mbar	10	1000	4	1000	5000
	0	0	0.01	0	0
	5	500	0.01	0	5
	10	1000	0.01	0	10
	0	0	1	0	0
	5	500	1	0	500
	10	1000	1	0	1000
	0	0	10	0	0
	5	500	10	0	5000
	10	1000	10	0	10000
	0	0	0.01	5	5
	5	500	0.01	5	10
	10	1000	0.01	5	15
	0	0	1	500	500
	5	500	1	500	1000
	10	1000	1	500	1500
	0	0	1	-200	-200
	5	500	1	-200	300
	10	1000	1	-200	800
	0	0	10	-10000	-10000
	10	1000	10	-10000	0
	0.02	2	0.01	0	0
	0.02	2	0.1	0	0
	0.02	2	1	0	2
	0.02	2	10	0	20

A sample application is found in the description of the "Analog comparator (Page 218)" SF.

For further information on analog inputs, refer to the Constants and connectors - Co (Page 138) topic.

## 4.4 Special functions list - SF



When you create your circuit program in LOGO!, you find the special function blocks in the SF list.



You can invert the inputs of SFs individually, that is, the circuit program converts a logical "1" at the input into a logical "0"; a logical "0" it converts into a logical "1". See the programming example in topic "Circuit program input (Page 86)".

The table also specifies whether the relevant function can be set retentive (Rem). The following SFs are available:

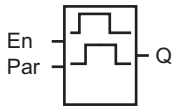
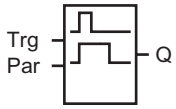
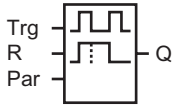
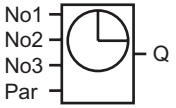
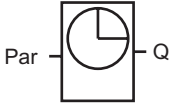
View in LOGO!	Name of the special function	Rem
<b>Times</b>		
	On-delay (Page 160)	REM
	Off-delay (Page 164)	REM
	On-/Off-delay (Page 166)	REM
	Retentive on-delay (Page 168)	REM
	Wiping relay (pulse output) (Page 170)	REM
	Edge triggered wiping relay (Page 172)	REM
	Asynchronous pulse generator (Page 175)	REM

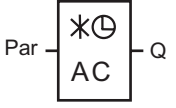
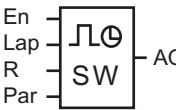
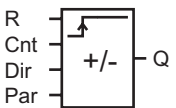

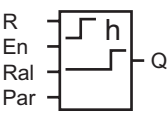
View in LOGO!	Name of the special function	Rem
	Random generator (Page 177)	
	Stairway lighting switch (Page 179)	REM
	Multiple function switch (Page 182)	REM
<p>LOGO! 0BA6:</p>  <p>LOGO! 0BA7:</p> 	Weekly timer (Page 185)	
	Yearly timer (Page 190)	
	Astronomical clock (0BA7 only) (Page 195)	
	Stopwatch (0BA7 only) (Page 198)	
<b>Counter</b>		
	Up/down counter (Page 201)	REM

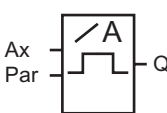
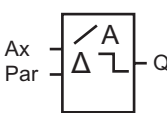
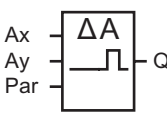
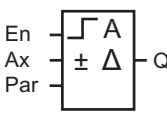
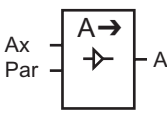
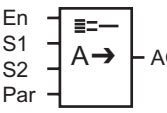
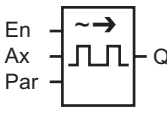
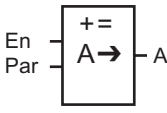
View in LOGO!	Name of the special function	Rem
	Hours counter (Page 205)	REM
	Threshold trigger (Page 210)	
<b>Analog</b>		
	Analog threshold trigger (Page 213)	
	Analog differential trigger (Page 216)	
	Analog comparator (Page 218)	
	Analog watchdog (Page 223)	
	Analog amplifier (Page 226)	
	Analog multiplexer (Page 248)	
	Pulse Width Modulator (PWM) (Page 261)	
	Mathematic instruction (Page 265)	

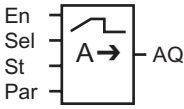
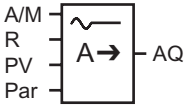
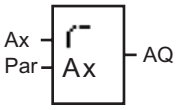
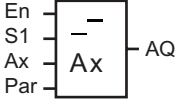
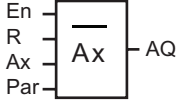
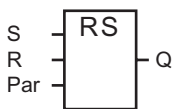
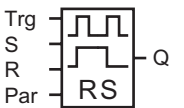
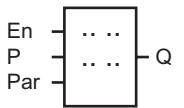
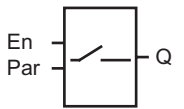
View in LOGO!	Name of the special function	Rem
	Analog Ramp (Page 251)	
	PI controller (Page 256)	REM
	Analog filter (0BA7 only) (Page 271)	
	Max/Min (0BA7 only) (Page 273)	REM
	Average value (0BA7 only) (Page 276)	REM
<b>Miscellaneous</b>		
	Latching relay (Page 228)	REM
	Pulse relay (Page 229)	REM
	Message texts (Page 231)	
	Softkey (Page 243)	REM

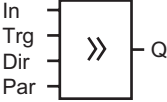
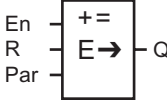
View in LOGO!	Name of the special function	Rem
	Shift register (Page 245)	REM
	Mathematic instruction error detection (Page 268)	

### 4.4.1 On-delay

#### Short description

The output is only set after a configurable on-delay time has expired.

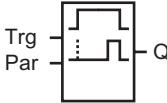
Symbol in LOGO!	Wiring	Description
	Input Trg	A signal at input Trg (Trigger) triggers the on-delay timer.
	Parameter	T represents the time after which the output is switched on (0 to 1 transition of the output signal). Retentivity: / = no retentivity R = the status is retentive.
	Output Q	Q is switched on when the set time T has expired, provided Trg is still set.

#### Parameter T

Note the defaults for parameter T in topic Time response (Page 151).

The time for parameter T can also be preset based on the actual value of another, already-configured function. You can use the actual values of the following functions:

- Analog comparator (Page 218) (actual value Ax - Ay)
- Analog threshold trigger (Page 213) (actual value Ax)
- Analog amplifier (Page 226) (actual value Ax)
- Analog multiplexer (Page 248) (actual value AQ)
- Analog ramp (Page 251) (actual value AQ)
- Mathematic instruction (Page 265) (actual value AQ)
- PI controller (Page 256) (actual value AQ)
- Up/down counter (Page 201) (actual value Cnt)

If your LOGO! is a LOGO! 0BA7, you can **additionally** use the actual values of the following functions:

- Analog filter (0BA7 only) (Page 271) (actual value AQ)
- Average value (0BA7 only) (Page 276) (actual value AQ)
- Max/Min (0BA7 only) (Page 273) (actual value AQ)
- On-delay (current time Ta)
- Off-delay (Page 164) (current time Ta)
- On-/off-delay (Page 166) (current time Ta)
- Retentive on-delay (Page 168) (current time Ta)
- Wiping relay(pulse output) (Page 170) (current time Ta)
- Edge triggered wiping relay (Page 172) (current time Ta)
- Asynchronous pulse generator (Page 175) (current time Ta)
- Stairway light switch (Page 179) (current time Ta)
- Multiple function switch (Page 182) (current time Ta)
- Stopwatch (Page 198) (actual value AQ)
- Threshold trigger (Page 210) (actual value Fre)

Select the required function by the block number. The timebase is configurable. Note the following listing:

#### Valid ranges of the timebase, if T = parameter

Timebase	max. value	min. resolution	Accuracy
s (seconds)	99:99	10 ms	+ 10 ms
m (minutes)	99:59	1s	+ 1 s
h (hours)	99:59	1 min	+ 1 min

The display in programming mode (example):

B12 +R  
T =04:10h

**Valid ranges of the timebase, if T = Actual value of an already-programmed function**

Timebase	max. value	Meaning	Accuracy
ms	99990	Number of ms	+ 10 ms
s	5999	Number of s	+ 1 s
m	5999	Number of min	+ 1 min

The display in programming mode (example):

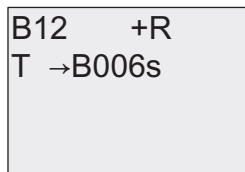

If the referenced block (B6, in the example) returns a value that lies out of the valid range, the value is rounded up or down to the next valid value.

**Parameter preset = Actual value of an already-programmed function**

How to include the actual value of an already-programmed function:

1. Press ► to move the cursor to the equal sign of parameter T.

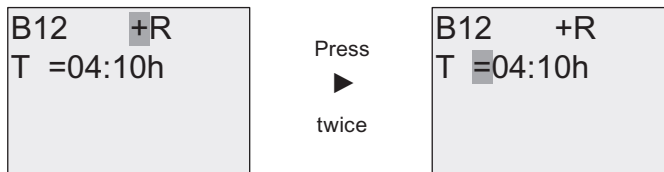

2. Press ▼ to change the equal sign into an arrow. If it exists, the last referenced block and its timebase is shown.

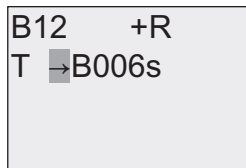

3. Press ► to move the cursor to the "B" of the shown block, and then press ▼ to select the required block number.
4. Press ► to move the cursor to the block's timebase and press ▼ to select the required timebase.

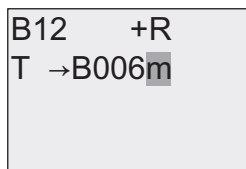

The view in parameter assignment mode (example):

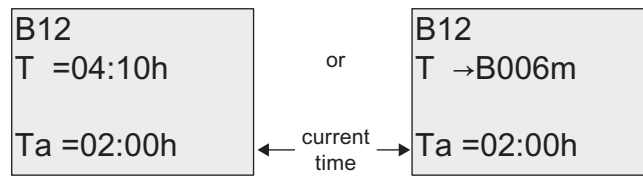

### Timing diagram

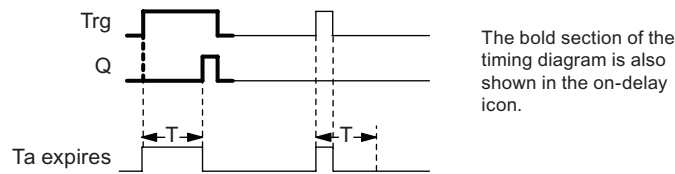

### Functional description

The time  $T_a$  is triggered with a 0 to 1 transition at input Trg ( $T_a$  is the current LOGO! time).

If the status of input Trg is 1 at least for the duration of the configured time T, the output is set to 1 on expiration of this time (the output follows the input with on-delay).

The time is reset when the status at input Trg returns to 0 before the time T has expired.

The output is reset to 0 when the signal at input Trg is 0.

If retentivity is not set, output Q and the expired time are reset after a power failure.

### 4.4.2 Off-delay

#### Short description

When an on-delay is set, the output is reset when the configured time has expired.

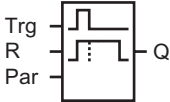
Symbol in LOGO!	Wiring	Description
	Input Trg	The off-delay timer starts with a negative edge (1 to 0 transition) at input Trg (Trigger)
	Input R	A signal at input R resets the on-delay time and the output.
	Parameter	The output switches off (transitions from 1 to 0) when the delay time T expires. Retentivity: / = No retentivity R = The status is retentive.
	Output Q	Q is set with a signal at input Trg. It holds this state until T has expired.

#### Parameter T

Note the parameter T defaults specified in topic Time response (Page 151).

The time for parameter T can be based on the actual value of another, already-configured function. You can use the actual value of the following functions:

- Analog comparator (Page 218) (actual value Ax - Ay)
- Analog threshold trigger (Page 213) (actual value Ax)
- Analog amplifier (Page 226) (actual value Ax)
- Analog multiplexer (Page 248) (actual value AQ)
- Analog Ramp (Page 251) (actual value AQ)
- Mathematic instruction (Page 265) (actual value AQ)
- PI controller (Page 256) (actual value AQ)
- Up/down counter (Page 201) (actual value Cnt)

If your LOGO! is a LOGO! 0BA7, you can **additionally** use the actual values of the following functions:

- Analog filter (0BA7 only) (Page 271) (actual value AQ)
- Average value (0BA7 only) (Page 276) (0BA7 only) (actual value AQ)
- Max/Min (0BA7 only) (Page 273) (0BA7 only) (actual value AQ)
- On-delay (Page 160) (current time Ta)
- Off-delay (current time Ta)
- On-/Off-delay (Page 166) (current time Ta)



- Retentive on-delay (Page 168) (current time  $T_a$ )
- Wiping relay (pulse output) (Page 170) (current time  $T_a$ )
- Edge triggered wiping relay (Page 172) (current time  $T_a$ )
- Asynchronous pulse generator (Page 175) (current time  $T_a$ )
- Stairway lighting switch (Page 179) (current time  $T_a$ )
- Multiple function switch (Page 182) (current time  $T_a$ )
- Stopwatch (0BA7 only) (Page 198) (actual value  $AQ$ )
- Threshold trigger (Page 210) (actual value  $Fre$ )

Select the required function by the block number. The timebase is configurable. For information on valid timebase ranges and parameter preset, refer to the On-delay (Page 160) topic.

### Timing diagram

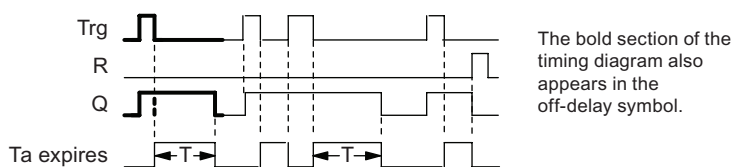

### Functional description

Output Q is set to hi immediately when the input Trg changes to hi.

The actual time  $T_a$  in LOGO! is retriggered at the 1 to 0 transition of Trg. The output remains set. Output Q is reset to 0 with off-delay when  $T_a$  reaches the value configured at T ( $T_a=T$ ).

The time  $T_a$  is retriggered with a one-shot at input Trg.

You can set input R (Reset) to reset the time  $T_a$  and the output before  $T_a$  has expired.

If retentivity is not set, output Q and the expired time are reset after a power failure.

### 4.4.3 On-/Off-delay

#### Short description

The on-/off-delay function sets the output after the set on-delay time has expired, and resets it upon expiration of the off-delay time.

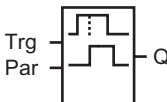
Symbol in LOGO!	Wiring	Description
	Input Trg	<p>A positive edge (0 to 1 transition) at input Trg (Trigger) triggers the on-delay time <math>T_H</math>.</p> <p>A negative edge (1 to 0 transition) at input Trg (Trigger) triggers the off-delay time <math>T_L</math>.</p>
	Parameter	<p><math>T_H</math> is the time after which the output is set hi (output signal transition 0 to 1).</p> <p><math>T_L</math> is the time after which the output is reset ( output signal transition 1 to 0).</p> <p>Retentivity:                      / = No retentivity                      R = The status is retentive.</p>
	Output Q	<p>Q is set when the configured time <math>T_H</math> has expired and Trg is still set. It is reset on expiration of the time <math>T_L</math>, if the trigger Trg has not been set again.</p>

#### Parameters $T_H$ and $T_L$

Note the preset values for the parameters  $T_H$  and  $T_L$  in topic Time response (Page 151).

The on-delay and off-delay times for parameters  $T_H$  and  $T_L$  can be based on the actual value of another, already-configured function. You can use the actual values of the following functions:

- Analog comparator (Page 218) (actual value Ax - Ay)
- Analog threshold trigger (Page 213) (actual value Ax)
- Analog amplifier (Page 226) (actual value Ax)
- Analog multiplexer (Page 248) (actual value AQ)
- Analog ramp (Page 251) (actual value AQ)
- Mathematic instruction (Page 265) (actual value AQ)
- PI controller (Page 256) (actual value AQ)
- Up/down counter (Page 201) (actual value Cnt)

If your LOGO! is a LOGO! 0BA7, you can **additionally** use the actual values of the following functions:

- Analog filter (0BA7 only) (Page 271) (actual value AQ)
- Average value (0BA7 only) (Page 276) (actual value AQ)
- Max/Min (0BA7 only) (Page 273) (actual value AQ)

- On-delay (Page 160) (current time Ta)
- Off-delay (Page 164) (current time Ta)
- On-/off-delay (current time Ta)
- Retentive on-delay (Page 168) (current time Ta)
- Wiping relay(pulse output) (Page 170) (current time Ta)
- Edge triggered wiping relay (Page 172) (current time Ta)
- Asynchronous pulse generator (Page 175) (current time Ta)
- Stairway light switch (Page 179) (current time Ta)
- Multiple function switch (Page 182) (current time Ta)
- Stopwatch (Page 198) (actual value AQ)
- Threshold trigger (Page 210) (actual value Fre)

Select the required function by the block number. The timebase is configurable. For information on valid timebase ranges and parameter preset, refer to the On-delay (Page 160).

### Timing diagram

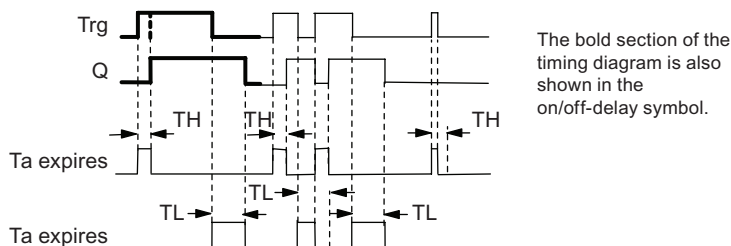

### Functional description

The time  $T_H$  is triggered with a 0 to 1 transition at input Trg.

If the status at input Trg is 1 at least for the duration of the time  $T_H$ , the output is set to 1 on expiration of the time  $T_H$  (the output follows the input with on-delay).

The time is reset when the signal at input Trg is reset to 0 before the time  $T_H$  has expired.

A 1 to 0 transition at input Trg triggers the time  $T_L$ .

If the status at input Trg is 0 at least for the duration of the signal  $T_L$ , the output is set to 0 on expiration of the time  $T_L$  (the output follows the input with off-delay).

The time is reset when the signal at input Trg changes to 1 again before the time  $T_L$  has expired.

If retentivity is not set, output Q and the expired time are reset after a power failure.

### 4.4.4 Retentive on-delay

#### Short description

A one-shot at the input triggers a configurable on-delay time. The output is set when this time has expired.

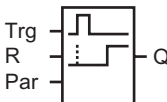
Symbol in LOGO!	Wiring	Description
	Input Trg	A signal at input Trg (Trigger) triggers the on-delay timer.
	Input R	A signal at input R resets the on-delay time and the output.
	Parameter	T represents the on-delay time for the output (output status transition 0 to 1). Retentivity: / = no retentivity R = The status is retentive.
	Output Q	Q is set after the time T has expired.

#### Parameter T

Note the defaults specified in topic Time response (Page 151).

The time for parameter T can be provided by the actual value of another already-programmed function. You can use the actual values of the following functions:

- Analog comparator (Page 218) (actual value Ax – Ay)
- Analog threshold trigger (Page 213) (actual value Ax)
- Analog amplifier (Page 226) (actual value Ax)
- Analog multiplexer (Page 248) (actual value AQ)
- Analog ramp (Page 251) (actual value AQ)
- Mathematic instruction (Page 265) (actual value AQ)
- PI controller (Page 256) (actual value AQ)
- Up/down counter (Page 201) (actual value Cnt)

If your LOGO! is a LOGO! 0BA7, you can **additionally** use the actual values of the following functions:

- Analog filter (0BA7 only) (Page 271) (actual value AQ)
- Average value (0BA7 only) (Page 276) (actual value AQ)
- Max/Min (0BA7 only) (Page 273) (actual value AQ)
- On-delay (Page 160) (current time Ta)
- Off-delay (Page 164) (current time Ta)
- On-/off-delay (Page 166) (current time Ta)

- Retentive on-delay (current time  $T_a$ )
- Wiping relay(pulse output) (Page 170) (current time  $T_a$ )
- Edge triggered wiping relay (Page 172) (current time  $T_a$ )
- Asynchronous pulse generator (Page 175) (current time  $T_a$ )
- Stairway light switch (Page 179) (current time  $T_a$ )
- Multiple function switch (Page 182) (current time  $T_a$ )
- Stopwatch (Page 198) (actual value  $AQ$ )
- Threshold trigger (Page 210) (actual value  $Fre$ )

Select the required function by the block number. The timebase is configurable. For information on valid ranges and parameter defaults, refer to the On-delay (Page 160) topic.

### Timing diagram

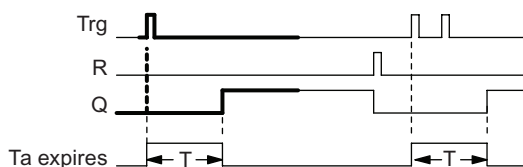

The bold section of the timing diagram is also shown in the symbol of the retentive on-delay.

### Functional description

The 0 to 1 signal transition at input Trg triggers the current time  $T_a$ . Output Q is set when  $T_a = T$ . A further signal at input Trg does not influence the time  $T_a$ .

The output and the time  $T_a$  are reset with the next 1 signal at input R.

If retentivity is not set, output Q and the expired time are reset after a power failure.

### 4.4.5 Wiping relay (pulse output)

#### Short description

An input signal generates a signal with a configurable period at the output.

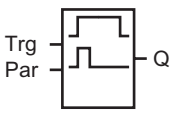
Symbol in LOGO!	Wiring	Description
	Input Trg	A signal at input Trg (Trigger) triggers the time for the wiping relay function.
	Parameter	The output is switched off after the time T has expired (output signal transition 1 to 0). Retentivity: / = No retentivity R = The status is retentive.
	Output Q	A signal at input Trg sets Q. If the input signal = 1, output Q remains set for the time Ta.

#### Parameter T

Note the information on parameter T in topic Time response (Page 151).

The time for parameter T can be provided by the actual value of another already-programmed function. You can use the actual values of the following functions:

- Analog comparator (Page 218) (actual value Ax – Ay)
- Analog threshold trigger (Page 213) (actual value Ax)
- Analog amplifier (Page 226) (actual value Ax)
- Analog multiplexer (Page 248) (actual value AQ)
- Analog ramp (Page 251) (actual value AQ)
- Mathematic instruction (Page 265) (actual value AQ)
- PI controller (Page 256) (actual value AQ)
- Up/down counter (Page 201) (actual value Cnt)

If your LOGO! is a LOGO! 0BA7, you can **additionally** use the actual values of the following functions:

- Analog filter (0BA7 only) (Page 271) (actual value AQ)
- Average value (0BA7 only) (Page 276) (actual value AQ)
- Max/Min (0BA7 only) (Page 273) (actual value AQ)
- On-delay (Page 160) (current time Ta)
- Off-delay (Page 164) (current time Ta)
- On-/off-delay (Page 166) (current time Ta)
- Retentive on-delay (Page 168) (current time Ta)

- Wiping relay (pulse output) (current time  $T_a$ )
- Edge triggered wiping relay (Page 172) (current time  $T_a$ )
- Asynchronous pulse generator (Page 175) (current time  $T_a$ )
- Stairway light switch (Page 179) (current time  $T_a$ )
- Multiple function switch (Page 182) (current time  $T_a$ )
- Stopwatch (Page 198) (actual value  $AQ$ )
- Threshold trigger (Page 210) (actual value  $Fre$ )

Select the required function by the block number. The timebase is configurable. For information on valid ranges and parameter defaults, refer to the On-delay (Page 160) topic.

### Timing diagram

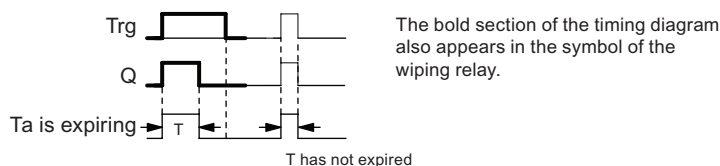

### Functional description

A 0 to 1 transition at input Trg sets the output, and triggers a time  $T_a$  during which the output remains set.

Output Q is reset to lo (pulse output) when  $T_a$  reaches the value preset at T ( $T_a = T$ ).

The output is immediately reset if there is a 1 to 0 transition at input Trg before the specified time has expired.

If retentivity is not set, output Q and the expired time are reset after a power failure.

### 4.4.6 Edge triggered wiping relay

#### Short description

An input pulse generates a preset number of output pulses with a defined pulse/pause ratio (retriggerable), after a configured delay time has expired.

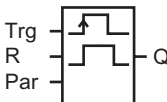
Symbol in LOGO!	Wiring	Description
	Input Trg	A signal at input Trg (Trigger) triggers the times for the edge triggered wiping relay.
	Input R	A signal at input R resets the current time ( $T_a$ ) and the output.
	Parameter	The interpulse width $T_L$ and the pulse width $T_H$ are configurable. N determines the number of pulse/pause cycles TL/TH: Range of values: 1...9 Retentivity: / = No retentivity R = The status is retentive.
	Output Q	Q is set after $T_L$ has expired, and reset after $T_H$ has expired.

#### Parameters TH and TL

Note the information on parameter T in topic Time response (Page 151).

The pulse width  $T_H$  and the interpulse width  $T_L$  can be provided by the actual value of another already-programmed function. You can use the actual values of the following functions:

- Analog comparator (Page 218) (actual value Ax – Ay)
- Analog threshold trigger (Page 213) (actual value Ax)
- Analog amplifier (Page 226) (actual value Ax)
- Analog multiplexer (Page 248) (actual value AQ)
- Analog ramp (Page 251) (actual value AQ)
- Mathematic instruction (Page 265) (actual value AQ)
- PI controller (Page 256) (actual value AQ)
- Up/down counter (Page 201) (actual value Cnt)

If your LOGO! is a LOGO! 0BA7, you can **additionally** use the actual values of the following functions:

- Analog filter (0BA7 only) (Page 271) (actual value AQ)
- Average value (0BA7 only) (Page 276) (actual value AQ)



- Max/Min (0BA7 only) (Page 273) (actual value AQ)
- On-delay (Page 160) (current time Ta)
- Off-delay (Page 164) (current time Ta)
- On-/off-delay (Page 166) (current time Ta)
- Retentive on-delay (Page 168) (current time Ta)
- Wiping relay(pulse output) (Page 170) (current time Ta)
- Edge triggered wiping relay (current time Ta)
- Asynchronous pulse generator (Page 175) (current time Ta)
- Stairway light switch (Page 179) (current time Ta)
- Multiple function switch (Page 182) (current time Ta)
- Stopwatch (Page 198) (actual value AQ)
- Threshold trigger (Page 210) (actual value Fre)

Select the required function by the block number. The timebase is configurable. For information on valid ranges and parameter defaults, refer to the On-delay (Page 160) topic.

### Timing diagram A

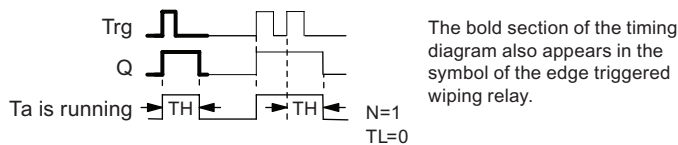

### Timing diagram B

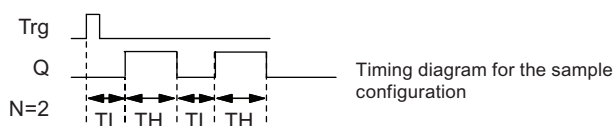

### Functional description

A 0 to 1 transition at input Trg triggers the time  $T_L$  (Time Low). After the time  $T_L$  has expired, output Q is set for the duration of  $T_H$  (Time High).

If there is a further 0 to 1 transition (retriggering pulse) at input Trg before the preset time ( $T_L + T_H$ ) has expired,  $T_a$  is reset and the pulse/pause cycle is restarted.

If retentivity is not set, output Q and the time are reset after a power failure.

### Setting the Par parameter

View in programming mode (example):

B25 1+R	← Protection mode and retentivity
TL =02:00s	← Interpulse width
TH =03:00s	← Pulse width

Press ►

B25 2	← Number of pulse/pause cycles (example)
N =1	

View in parameter assignment mode (example):

B25	← Current pulse width $T_L$ or $T_H$
TL =02:00s	
TH =03:00s	
Ta =01:15s	

## 4.4.7 Asynchronous pulse generator

### Short description

The output pulse shape can be modified by reconfiguring the pulse/pause ratio.

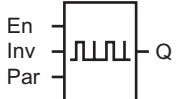
Symbol in LOGO!	Wiring	Description
	Input En	You can use input EN to set and reset the asynchronous pulse generator.
	Input INV	Input INV can be used to invert the output signal of the active asynchronous pulse generator.
	Parameter	You can configure the pulse width $T_H$ and the interpulse width $T_L$ . Retentivity: / = No retentivity R = The status is retentive.
	Output Q	Q is set and reset cyclically according to the pulse/pause ratio $T_H$ and $T_L$ .

### Parameters $T_H$ and $T_L$

Note the information on parameter T in topic Time response (Page 151)

The pulse width  $T_H$  and the interpulse width  $T_L$  can be provided by the actual value of another already-programmed function. You can use the actual values of the following functions:

- Analog comparator (Page 218) (actual value Ax – Ay)
- Analog threshold trigger (Page 213) (actual value Ax)
- Analog amplifier (Page 226) (actual value Ax)
- Analog multiplexer (Page 248) (actual value AQ)
- Analog ramp (Page 251) (actual value AQ)
- Mathematic instruction (Page 265) (actual value AQ)
- PI controller (Page 256) (actual value AQ)
- Up/down counter (Page 201) (actual value Cnt)

If your LOGO! is a LOGO! 0BA7, you can **additionally** use the actual values of the following functions:

- Analog filter (0BA7 only) (Page 271) (actual value AQ)
- Average value (0BA7 only) (Page 276) (actual value AQ)
- Max/Min (0BA7 only) (Page 273) (actual value AQ)
- On-delay (Page 160) (current time  $T_a$ )
- Off-delay (Page 164) (current time  $T_a$ )

- On-/off-delay (Page 166) (current time Ta)
- Retentive on-delay (Page 168) (current time Ta)
- Wiping relay(pulse output) (Page 170) (current time Ta)
- Edge triggered wiping relay (Page 172) (current time Ta)
- Aysnchronous pulse generator (current time Ta)
- Stairway light switch (Page 179) (current time Ta)
- Multiple function switch (Page 182) (current time Ta)
- Stopwatch (Page 198) (actual value AQ)
- Threshold trigger (Page 210) (actual value Fre)

Select the required function by the block number. The timebase is configurable. For information on valid ranges and parameter defaults, refer to the On-delay (Page 160) topic.

### Timing diagram

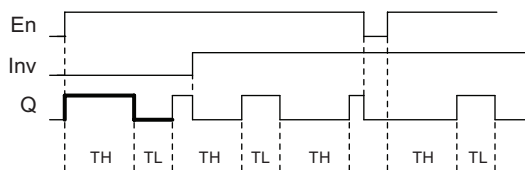

### Functional description

You can configure the pulse/interpulse width at the  $T_H$  (Time High) and  $T_L$  (Time Low) parameters.

Input Inv can be used to invert the output signal, provided the block is enabled with a signal at input EN.

If retentivity is not set, output Q and the expired time are reset after a power failure.

## 4.4.8 Random generator

### Short description

The output of the random generator is set or reset within a configured time.

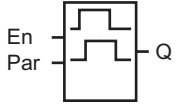
Symbol in LOGO!	Wiring	Description
	Input En	<p>A positive edge ( 0 to 1 transition) at input En (Enable) triggers the on-delay time of the random generator.</p> <p>A negative edge ( 1 to 0 transition) at input En (Enable) triggers the off-delay time of the random generator.</p>
	Parameter	<p>The on-delay is set at random to a value between 0 s and <math>T_H</math>.</p> <p>The off-delay is set at random to a value between 0 s and <math>T_L</math>.</p>
	Output Q	<p>Output Q is set when the on-delay has expired and if En is still set. It is reset when the off-delay has expired, provided En was not set again meanwhile.</p>

### Parameter $T_H$ and $T_L$

Note the defaults of the  $T_H$  and  $T_L$  parameters listed in topic Time response (Page 151).

The on-delay time  $T_H$  and the off-delay time  $T_L$  can be provided by the actual value of another already-programmed function. You can use the actual values of the following functions:

- Analog comparator (Page 218) (actual value  $A_x - A_y$ )
- Analog threshold trigger (Page 213) (actual value  $A_x$ )
- Analog amplifier (Page 226) (actual value  $A_x$ )
- Analog multiplexer (Page 248) (actual value  $A_Q$ )
- Analog ramp (Page 251) (actual value  $A_Q$ )
- Mathematic instruction (Page 265) (actual value  $A_Q$ )
- PI controller (Page 256) (actual value  $A_Q$ )
- Up/down counter (Page 201) (actual value  $Cnt$ )

If your LOGO! is a LOGO! 0BA7, you can **additionally** use the actual values of the following functions:

- Analog filter (0BA7 only) (Page 271) (actual value  $A_Q$ )
- Average value (0BA7 only) (Page 276) (actual value  $A_Q$ )
- Max/Min (0BA7 only) (Page 273) (actual value  $A_Q$ )
- On-delay (Page 160) (current time  $T_a$ )

- Off-delay (Page 164) (current time  $T_a$ )
- On-/off-delay (Page 166) (current time  $T_a$ )
- Retentive on-delay (Page 168) (current time  $T_a$ )
- Wiping relay(pulse output) (Page 170) (current time  $T_a$ )
- Edge triggered wiping relay (Page 172) (current time  $T_a$ )
- Asynchronous pulse generator (Page 175) (current time  $T_a$ )
- Stairway light switch (Page 179) (current time  $T_a$ )
- Multiple function switch (Page 182) (current time  $T_a$ )
- Stopwatch (Page 198) (actual value  $AQ$ )
- Threshold trigger (Page 210) (actual value  $Fre$ )

Select the required function by the block number. The timebase is configurable. For information on valid ranges and parameter defaults, refer to the On-delay (Page 160) topic.

### Timing diagram

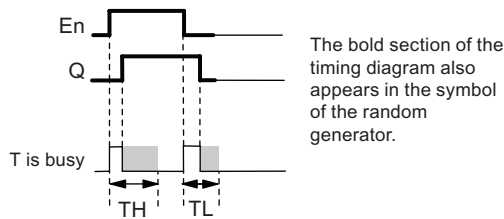

### Functional description

The 0 to 1 transition at input  $En$  triggers a random on-delay time between 0 s and  $T_H$ . The output is set when the on-delay time has expired and if the signal at input  $En$  remains hi at least for the duration of this time.

The time is reset if input  $En$  is reset before the on-delay time has expired.

A 1 to 0 transition at input  $EN$  triggers a random off-delay time between 0 s and  $T_L$ .

The output is reset after the off-delay time has expired, provided input  $En$  remains lo at least for the duration of this time.

The time is reset if the signal at input  $En$  changes to 1 again before the off-delay time has expired.

The time expired is reset after a power failure.

## 4.4.9 Stairway lighting switch

### Short description

An input edge triggers a configurable and retriggerable time. The output is reset after this time has expired. A warning signal can be output before this time has expired to warn of the impending shutdown.

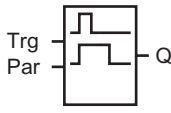
Symbol in LOGO!	Wiring	Description
	Input Trg	A signal at input Trg (Trigger) triggers the off-delay time for the stairway lighting switch.
	Parameter	<p>T represents the off-delay time of the output (output signal transition 1 to 0).</p> <p><math>T_I</math> determines the triggering time for the pre-warning.</p> <p><math>T_{IL}</math> determines the length of the pre-warning signal.</p> <p>Retentivity: / = No retentivity R = The status is retentive.</p>
	Output Q	Q is reset after the time T has expired. A warning signal can be output before this time has expired.

### Parameter T, $T_I$ and $T_{IL}$

Note the defaults of the T parameters listed in topic Time response (Page 151).

The off-delay time T, the pre-warning time  $T_I$  and the pre-warning period  $T_{IL}$  can be provided by the actual value of another already-programmed function. You can use the actual values of the following functions:

- Analog comparator (Page 218) (actual value Ax – Ay)
- Analog threshold trigger (Page 213) (actual value Ax)
- Analog amplifier (Page 226) (actual value Ax)
- Analog multiplexer (Page 248) (actual value AQ)
- Analog ramp (Page 251) (actual value AQ)
- Mathematic instruction (Page 265) (actual value AQ)
- PI controller (Page 256) (actual value AQ)
- Up/down counter (Page 201) (actual value Cnt)

If your LOGO! is a LOGO! 0BA7, you can **additionally** use the actual values of the following functions:

- Analog filter (0BA7 only) (Page 271) (actual value AQ)
- Average value (0BA7 only) (Page 276) (actual value AQ)
- Max/Min (0BA7 only) (Page 273) (actual value AQ)
- On-delay (Page 160) (current time Ta)

- Off-delay (Page 164) (current time  $T_a$ )
- On-/off-delay (Page 166) (current time  $T_a$ )
- Retentive on-delay (Page 168) (current time  $T_a$ )
- Wiping relay(pulse output) (Page 170) (current time  $T_a$ )
- Edge triggered wiping relay (Page 172) (current time  $T_a$ )
- Asynchronous pulse generator (Page 175) (current time  $T_a$ )
- Stairway lightswitch (current time  $T_a$ )
- Multiple function switch (Page 182) (current time  $T_a$ )
- Stopwatch (Page 198) (actual value AQ)
- Threshold trigger (Page 210) (actual value Fre)

Select the required function by the block number. The timebase is configurable. For information on valid ranges and parameter defaults, refer to the On-delay (Page 160) topic.

**Timing diagram**

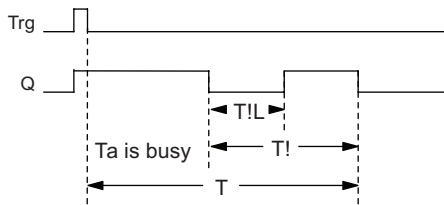

**Functional description**

A 0 to 1 signal transition at input Trg sets output Q. The next 1 to 0 transition at Trg retriggers the current time  $T_a$ , and output Q remains set.

Output Q is reset when  $T_a = T$ . You can output a warning signal before the off-delay time ( $T - T_l$ ) has expired to reset Q for the time of the pre-warning period  $T_{lL}$ .

A further one-shot at input Trg during  $T_a$  retriggers the time  $T_a$ .

If retentivity is not set, output Q and the expired time are reset after a power failure.



## Setting the Par parameter

Note the defaults specified in topic Time response (Page 151).

---

### Note

All times must have the same timebase.

---

View in programming mode (example):

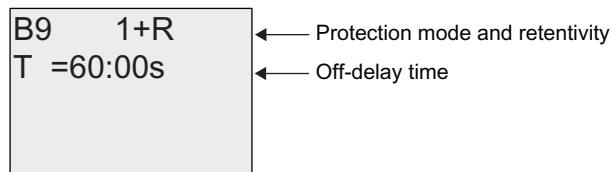

Press ►

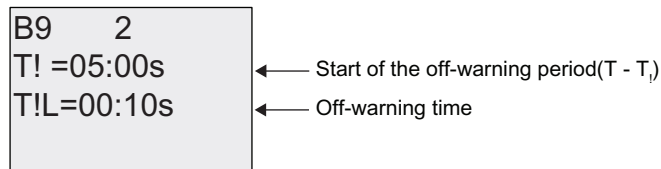

View in parameter assignment mode (example):



### 4.4.10 Multiple function switch

#### Short description

Switch with two different functions:

- Pulse switch with off-delay
- Switch (permanent lighting)

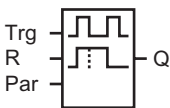
Symbol in LOGO!	Wiring	Description
	Input Trg	A signal at input Trg (Trigger) sets output Q (permanent light) or resets Q with an off-delay. When active, output Q can be reset with a signal at input Trg.
	Input R	A signal at input R resets the current time $T_a$ and resets the output.
	Parameter	<p>T represents the off-delay time. The output is reset (1 to 0 transition) when time T expires.</p> <p><math>T_L</math> represents the time during which the output must be set to enable the permanent light function.</p> <p><math>T_I</math> represents the on-delay for the prewarning time.</p> <p><math>T_{IL}</math> represents the length of the prewarning time period.</p> <p>Retentivity:                      / = No retentivity                      R = The status is retentive.</p>
	Output Q	A signal at Trg switches on output Q. Depending on the length of the input at Trg, the output is switched off again or switched on permanently, or it is reset with a further signal at Trg.

#### Parameters T, $T_L$ , $T_I$ and $T_{IL}$

Note the defaults of the T parameters listed in topic Time response (Page 151).

The off-delay time T, the permanent light time  $T_L$ , the on-delay prewarning time  $T_I$  and the prewarning time period  $T_{IL}$  can be provided by the actual value of another already-programmed function. You can use the actual values of the following functions:

- Analog comparator (Page 218) (actual value  $A_x - A_y$ )
- Analog threshold trigger (Page 213) (actual value  $A_x$ )
- Analog amplifier (Page 226) (actual value  $A_x$ )
- Analog multiplexer (Page 248) (actual value  $A_Q$ )
- Analog ramp (Page 251) (actual value  $A_Q$ )
- Mathematic instruction (Page 265) (actual value  $A_Q$ )
- PI controller (Page 256) (actual value  $A_Q$ )
- Up/down counter (Page 201) (actual value Cnt)

If your LOGO! is a LOGO! 0BA7, you can **additionally** use the actual values of the following functions:

- Analog filter (0BA7 only) (Page 271) (actual value AQ)
- Average value (0BA7 only) (Page 276) (actual value AQ)
- Max/Min (0BA7 only) (Page 273) (actual value AQ)
- On-delay (Page 160) (current time  $T_a$ )
- Off-delay (Page 164) (current time  $T_a$ )
- On-/off-delay (Page 166) (current time  $T_a$ )
- Retentive on-delay (Page 168) (current time  $T_a$ )
- Wiping relay(pulse output) (Page 170) (current time  $T_a$ )
- Edge triggered wiping relay (Page 172) (current time  $T_a$ )
- Asynchronous pulse generator (Page 175) (current time  $T_a$ )
- Stairway light switch (Page 179) (current time  $T_a$ )
- Multiple function switch (current time  $T_a$ )
- Stopwatch (Page 198) (actual value AQ)
- Threshold trigger (Page 210) (actual value Fre)

Select the required function by the block number. The timebase is configurable. For information on valid ranges and parameter defaults, refer to the On-delay (Page 160) topic.

### Timing diagram

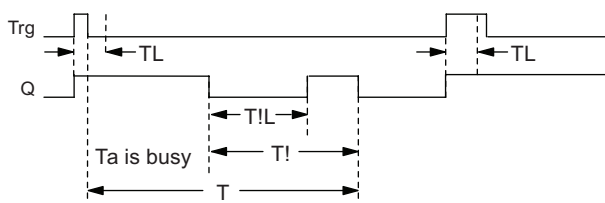

### Functional description

A 0 to 1 transition at input Trg sets output Q.

If output  $Q = 0$ , and input Trg is set hi at least for the duration of  $T_L$ , the permanent lighting function is enabled and output Q is set accordingly.

The off-delay T is triggered when input Trg returns to 0 before  $T_L$  has expired.

Output Q is reset when  $T_a = T$ .

You can output an off-warning signal prior to the expiration of the off-delay time ( $T - T_I!$ ) that resets Q for the duration of the prewarning time period  $T_I!$ . A subsequent signal at Trg always resets T and the output Q.

If retentivity is not set, output Q and the expired time are reset after a power failure.

### Setting the Par parameter

Note the defaults specified in the topic "Time response (Page 151)".

---

#### Note

T, T! and T!L must all have the same timebase.

---

View in programming mode (example):

B5 1+R T =60:00s TL =10:00s	← Protection mode and retentivity
	← Off-delay
	← Permanent light on-time

Press ►

B5 2 T! =30:00s T!L=20:00s	← Start of the off-warning period(T - T <sub>l</sub> )
	← Off-warning time

View in parameter assignment mode (example):

B5 1 T =60:00s TL =10:00s Ta =06:00s	← Current value of the time T <sub>L</sub> or T
---	---

## 4.4.11 Weekly timer

### Short description

The output is controlled by means of a configurable on/off date. The function supports any combination of weekdays. You select the active weekdays by hiding the inactive days.

### Note

Because LOGO! 24/24o does not have a real-time clock, the weekly timer function is not available for both versions.

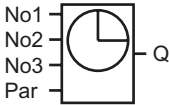
Symbol in LOGO! 0BA6	Wiring	Description
	Cam parameters 1, 2, and 3	At the Cam parameters, you set the on- and off-times of the weekly timer for each <b>Cam</b> switch. Here you also configure the days and the time-of-day.
	Par	You specify whether the timer pulses on for one cycle when activated and then reset. The pulse setting applies to all three cams.
	Output Q	Q is set when the configured cam is actuated.

Symbol in LOGO! 0BA7	Wiring	Description
	Cam parameters 1, 2 and 3	At the Cam parameters, you set the on- and off-times of the weekly timer for each <b>Cam</b> switch. Here you also configure the days and the time-of-day.  You can also specify whether the timer pulses on for one cycle when activated and then reset. The pulse setting applies to all three cams.
	Output Q	Q is set when the configured cam is actuated.

### Timing diagram (three examples)

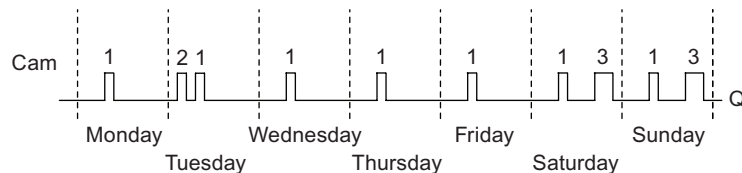

Cam 1:	Daily:	06:30 h to 8:00 h
Cam 2:	Tuesday:	03:10 h to 04:15 h
Cam 3:	Saturday and Sunday:	16:30 h to 23:10 h

**Functional description**

Each weekly timer has three cams you can use to configure a time hysteresis. You specify the on- and off-times at the Cam parameters. The weekly timer sets the output at a certain on-time, if this is not already set.

The weekly timer resets the output at a certain off-time if you configured an off-time, or at the end of the cycle if you specified a pulse output. You will cause a conflict if the on- and off-times you set for the weekly timer are identical, though set on different cams. In this case, cam3 takes priority over cam2, whereas cam2 takes priority over cam1.

The switching state of the weekly timer is determined by the status of all three cams.

**Parameter assignment screen form (LOGO! 0BA6)**

View of the parameter assignment screen form, for example for Cam1 and the Pulse setting:

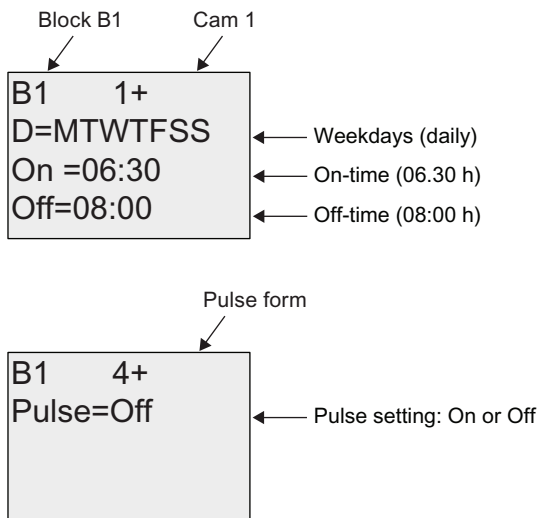

**Parameter assignment screen form (LOGO! 0BA7)**

View of the parameter assignment screen form, for example for Cam1 and the Pulse setting:

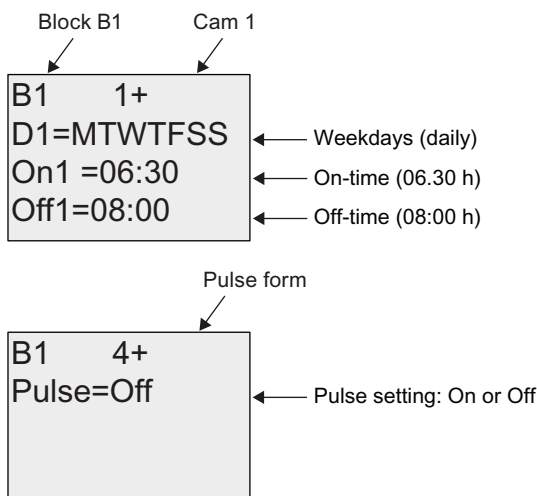

## Days of the week

The prefix "D=" (Day) has the following meaning:

- M: Monday
- T: Tuesday
- W: Wednesday
- T: Thursday
- F: Friday
- S: Saturday
- S: Sunday

Uppercase letters indicate a specific day of the week. A "-" indicates no selection for the day of the week.

## On-/Off-times

Any time between 00:00 h and 23:59 h is possible. You can also configure the on time to be a pulse signal. The timer block will be activated at the specified time for one cycle and then the output is reset.

--:- means: No on-/off-times set.

## Setting the weekly timer

To set the on-/off-times:

1. Move the cursor to one of the Cam parameters of the timer (e.g. No1).
2. Press **OK**. LOGO! opens the Cam parameter assignment screen form. The cursor is positioned on the day of the week.
3. Press **▲** and **▼** to select one or several days of the week.
4. Press **▶** to move the cursor to the first position of the on-time.
5. Set the on-time.  
Modify the value at the respective position, using the keys **▲** and **▼**. Move to the cursor to the various positions, using the keys **◀** and **▶**. At the first position, you can only select the value --:-  
(--:- means: No on-/off-times set).
6. Press **▶** to move the cursor to the first position of the off-time.
7. Set the off-time (in same way as in step 5).
8. Confirm your entries with **OK**.

The cursor is now positioned on the No2 parameter (Cam2) and you can configure a further cam.

---

### Note

For information on timer accuracy, refer to the technical data and to the topic "Time response (Page 151)".

---

### Weekly timer: Example

The output of the weekly timer switch is to be set daily from 06:30 h to 08:00 h. The output should also be set every Tuesday from 03:10 h to 04:15 h, and on the weekends from 16:30 h to 23:10 h.

This requires three cams.

Here are the parameter assignment screen forms of the cams No 1, 2 and 3, based on the timing diagram shown earlier.

#### Cam1

Cam No1 must set the output of the weekly timer daily from 06:30 h to 08:00 h.

View in LOGO! 0BA6:

```
B1  1+
D=MTWTFSS
On=06:30
Off=08:00
```

View in LOGO! 0BA7:

```
B1  1+
D1=MTWTFSS
On1=06:30
Off1=08:00
```

#### Cam2

Cam No2 must set the output of the weekly timer every Tuesday from 03:10 h to 04:15 h.

View in LOGO! 0BA6:

```
B1  2
D=-T-----
On =03:10
Off=04:15
```

View in LOGO! 0BA7:

```
B1  2
D2=-T-----
On2=03:10
Off2=04:15
```



### Cam3

Cam No3 must set the output of the weekly timer switch every Saturday and Sunday from 16:30 h to 23:10 h.

View in LOGO! 0BA6:

```
B1 3
D=-----SS
On =16:30
Off=23:10
```

View in LOGO! 0BA7:

```
B1 3
D3=-----SS
On3=16:30
Off3=23:10
```

### Result

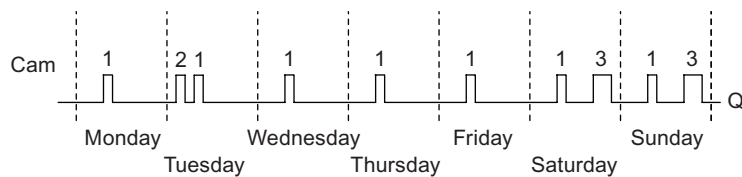

### 4.4.12 Yearly timer

#### Short description

The output is controlled by means of a configurable on/off date. You can configure the timer to activate on a yearly, monthly, or user-defined time basis. With any mode, you can also configure the timer to pulse the output during the defined time period. The time period is configurable within the date range of January 1, 2000 to December 31, 2099.

#### Note

Because LOGO! 24/24o does not have a real-time clock, the yearly timer is not available for both versions.

Symbol in LOGO!	Wiring	Description
	Cam parameter	At the Cam parameter, you configure the timer mode, the on-/off-times for the timer, and whether the output is a pulse output.
	Output Q	Q is set when the configured cam is switched on.

#### Timing diagrams

**Example 1:** Yearly mode on, Monthly mode off, Pulse Off, On Time = 2000-06-01, Off Time = 2099-08-31: Every year on June 1 the timer output switches on and remains on until August 31.

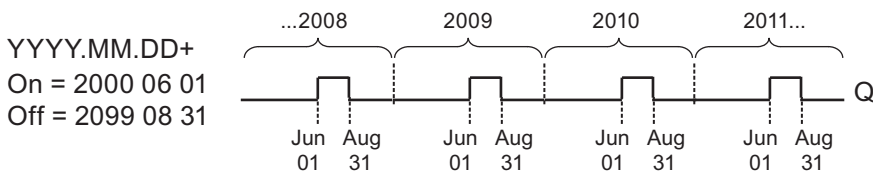

B6 1+  
 Yearly = On  
 Monthly = Off  
 Pulse = Off

B6 2+  
 ON :  
 YYYY-MM-DD  
 2000-06-01

B6 3+  
 OFF :  
 YYYY-MM-DD  
 2099-08-31

**Example 2:** Yearly mode on, Monthly mode off, Pulse on, On Time = 2000-03-15, Off Time = 2099-\*\*-\*\*. Every year on March 15, the timer switches on for one cycle.

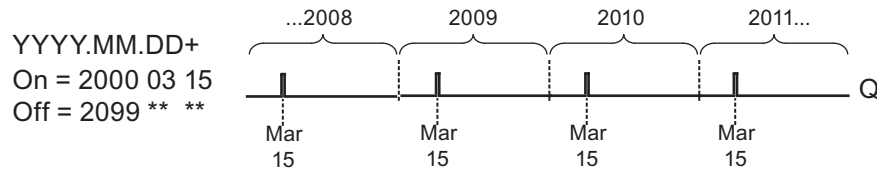

B6 1+  
Yearly = On  
Monthly = Off  
Pulse = On

B6 2+  
ON :  
YYYY-MM-DD  
2000-03-15

B6 3+  
OFF :  
YYYY-MM-DD  
2099-\*\*-\*\*

**Example 3:** Yearly mode on, Monthly mode off, Pulse off, On Time = 2008-06-01, Off Time = 2010-08-31: On June 1 of 2008, 2009, and 2010 the timer output switches on and remains on until August 31.

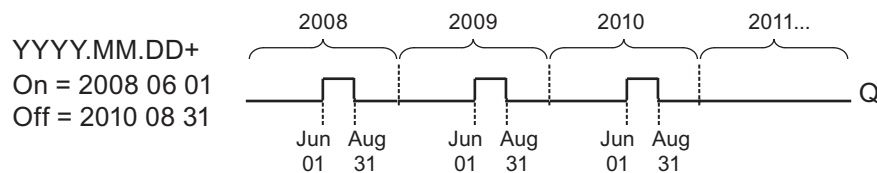

B6 1+  
Yearly = On  
Monthly = Off  
Pulse = Off

B6 2+  
ON :  
YYYY-MM-DD  
2008-06-01

B6 3+  
OFF :  
YYYY-MM-DD  
2010-08-31

**Example 4:** Yearly mode on, Monthly mode off, Pulse on, On Time = 2008-03-15, Off Time = 2010-\*\*-\*\*. On March 15 of 2008, 2009, and 2010, the timer output switches on for one cycle.

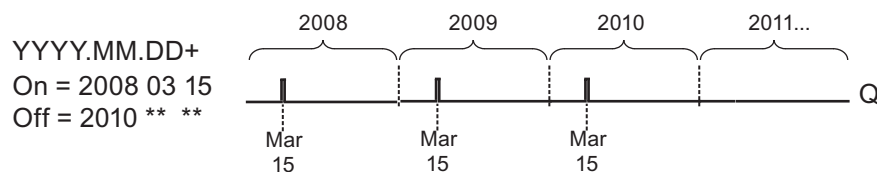

B6 1+  
Yearly = On  
Monthly = Off  
Pulse = On

B6 2+  
ON :  
YYYY-MM-DD  
2008-03-15

B6 3+  
OFF :  
YYYY-MM-DD  
2010-\*\*-\*\*

4.4 Special functions list - SF

**Example 5:** Yearly mode off, Monthly mode off, Pulse off, On Time = 2008-06-01, Off Time = 2008-08-31: On June 1, 2008 the timer output switches on and remains on until August 31, 2010.

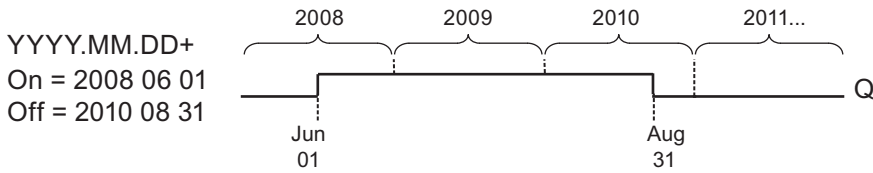

YYYY.MM.DD+  
On = 2008 06 01  
Off = 2010 08 31

B6 1+  
Yearly = Off  
Monthly = Off  
Pulse = Off

B6 2+  
ON :  
YYYY-MM-DD  
2008-06-01

B6 3+  
OFF :  
YYYY-MM-DD  
2010-08-31

**Example 6:** Yearly mode off, Monthly mode off, Pulse selected, On Time = 2008-03-15, Off Time = \*\*\*\*\_\*\_\*\_\*\_\*: On March 15, 2008 the timer output switches on for one cycle. Because the timer does not have a monthly action or yearly action, the timer output pulses only one time at the specified On Time.

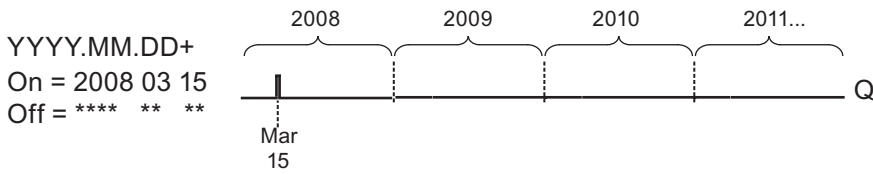

YYYY.MM.DD+  
On = 2008 03 15  
Off = \*\*\*\* \* \* \*

B6 1+  
Yearly = Off  
Monthly = Off  
Pulse = On

B6 2+  
ON :  
YYYY-MM-DD  
2008-03-15

B6 3+  
OFF :  
YYYY-MM-DD  
\*\*\*\*\_\*\_\*\_\*\_\*

**Example 7:** Yearly mode on, Monthly mode off, Pulse off, On Time = 2008-12-15, Off Time = 2010-01-07: On December 15 of 2008 and 2009, the timer output switches on and remains on until January 7 of the following year. When the timer output turns off on January 7, 2010 it does NOT turn on again the following December 15.

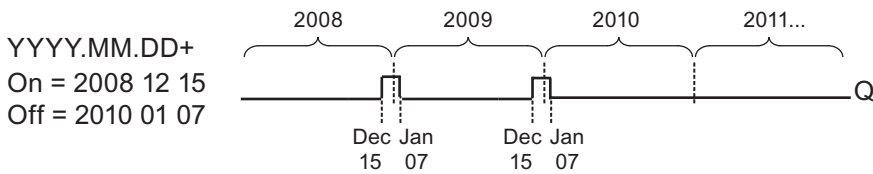

YYYY.MM.DD+  
On = 2008 12 15  
Off = 2010 01 07

B6 1+  
Yearly = On  
Monthly = Off  
Pulse = Off

B6 2+  
ON :  
YYYY-MM-DD  
2008-12-15

B6 3+  
OFF :  
YYYY-MM-DD  
2010-01-07

**Example 8:** Yearly mode on, Monthly mode on, On Time = 2008-\*\*-01, Off Time = 2010-\*\*-05: Starting in 2008, on the first day of each month the timer output switches on and switches off on the fifth day of the month. The timer continues in this pattern through the last month of 2010.

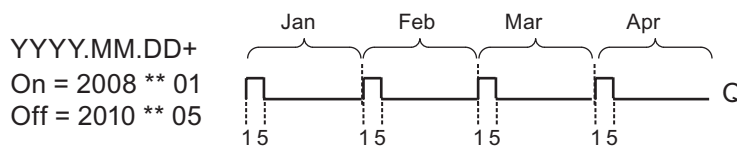

B6	1+
Yearly = On	
Monthly = On	
Pulse = Off	

B6	2+
ON :	
YYYY-MM-DD	
2008-**-01	

B6	3+
OFF :	
YYYY-MM-DD	
2010-**-05	

## Functional description

The yearly timer sets and resets the output at specific on and off dates. Sets and resets are executed at 00:00. If your application requires a different time, use a weekly timer together with a yearly timer in your circuit program.

The on time specifies when the timer is activated. The off time specifies when the output is reset again. For the on and off times, note the order of the fields: The first field defines the year, the second the month and the third the day.

If you set the Monthly mode on, the timer output switches on each month at the specified day of the on time and remains on until the specified day of the off time. The on time specifies the initial year in which the timer is activated. The off time defines the last year in which the timer turns off. The maximum year is 2099.

If you set the Yearly mode on, the timer output switches on each year at the specified month and day of the on time and remains on until the specified month and day of the off time. The on time specifies the initial year in which the timer is activated. The off time defines the last year in which the timer turns off. The maximum year is 2099.

If you set Pulse output, the timer output switches on at the specified on time for one cycle and then the timer output is reset. You can choose to pulse a timer on a monthly or yearly basis, or just a single time.

If you set none of the Monthly, Yearly, or Pulse modes on, you can define a specific time period with the on time and off time. It can span any time period that you choose.

For a process action that is to be switched on and off at multiple but irregular times during the year, you can define multiple yearly timers with the outputs connected by an OR function block.

**Backup of the real-time clock**

The internal real-time clock of LOGO! is buffered against power failure. The buffering time is influenced by the ambient temperature, and is typically 80 hours at an ambient temperature of 25°C. If you are using the optional LOGO! Battery card, or combined LOGO! Memory/Battery card, LOGO! can retain the clock time for up to two years.

**Sample configuration**

The output of a LOGO! is to be set annually on March 1, reset on April 4, set again on July 7, and reset again on November 19. You need to configure two yearly timers with corresponding on-times. Then logically link the outputs by means of an OR block.

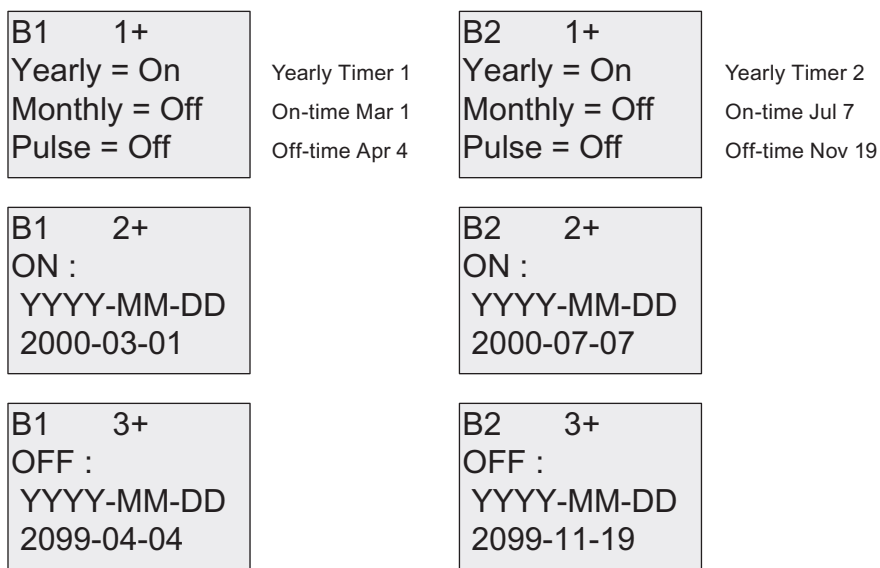

**Result**

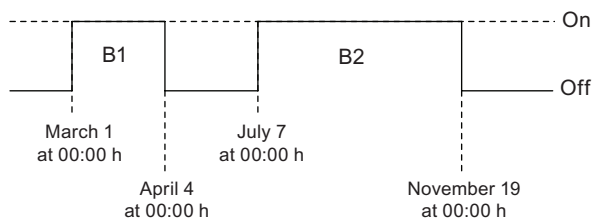

### 4.4.13 Astronomical clock (OBA7 only)

#### Short description

The astronomical clock function is used to set an output high when the current time of your LOGO! Base Module is between the time of sunrise (TR) and the time of sunset (TS). LOGO! automatically calculates these times based on the geographical location, the settings for automatic summertime/wintertime conversion, and the current time of the module.

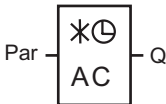
Symbol in LOGO!	Wiring	Description
	Parameter	<p>You specify the longitude, altitude and time zone:</p> <p><b>Longitude:</b>                      Direction settings:                      EAST or WEST                      Range of values:                      0 to 180° (degrees)                      0 to 59' (minutes)                      0 to 59" (seconds)</p> <p><b>Latitude:</b>                      Direction settings:                      NORTH or SOUTH                      Range of values:                      0 to 90° (degrees)                      0 to 59' (minutes)                      0 to 59" (seconds)</p> <p><b>Zone:</b>                      Range of values:                      -11 to 12</p>
	Output Q	Q is set to "1" when the current time of your LOGO! Base Module is between the sunrise time (TR) and the sunset time (TS).

#### Note

From LOGO!Soft Comfort V7.0, you can choose from several pre-defined time zone locations. If you select one of these locations, LOGO!Soft Comfort uses the latitude, longitude, and the time zone of your selection. This location pre-configuration capability is only possible from LOGO!Soft Comfort.

**Timing diagram**

The following illustration is an example of the timing diagram where Ta refers to the current time of the LOGO! Base Module:

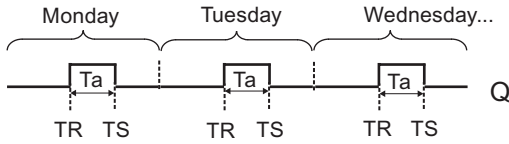

**Functional description**

The function calculates the TR and TS values at the input and sets Q when Ta (Ta is the current LOGO! Time) is between TR and TS; otherwise, the function resets Q.

If automatic summertime/wintertime conversion (see the topic Summertime/wintertime conversion (Page 111) for details) is enabled, the function takes the configured time difference into consideration when calculating the TR and TS values.

**Setting the Par parameter**

View in programming mode (example):

B1	1+	← Protection mode
Longitude		
EAST		← Direction (EAST/WEST)
080°23'05"		← Value (degrees, minutes and seconds)

Press ►

B1	2+	← Protection mode
Latitude		
NORTH		← Direction (NORTH/SOUTH)
050°10'00"		← Value (degrees, minutes and seconds)

Press ►

B1	3+	← Protection mode
Zone: GMT +08		← Time zone



View in parameter assignment mode (example):

B1	1
Longitude	
EAST	
80°23' 5"	

Press ▼

B1	2
Latitude	
NORTH	
50°10' 0"	

If automatic summertime/wintertime conversion is disabled, press ▼ and LOGO! shows the following view in parameter assignment mode (example):

B1	3
Zone: GMT +08	
TR =10:38	
TS =18:46	

← Time zone  
← Sunrise time  
← Sunset time

If automatic summertime/wintertime conversion is enabled and set to "EU" (for example), press ▼ and LOGO! shows the following view in parameter assignment mode (example):

B1	3
Zone: GMT +08	
TR =11:38	
TS =19:46	

### 4.4.14 Stopwatch (0BA7 only)

#### Short description

The stopwatch function counts the elapsed time between a start stopwatch signal and a stop stopwatch signal.

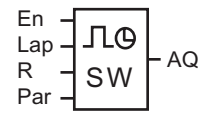
Symbol in LOGO!	Wiring	Description
	En	A signal at input En begins counting elapsed time at analog output AQ.
	Lap	A positive edge (0 to 1 transition) at input Lap pauses the stopwatch. A negative edge (1 to 0 transition) at input Lap resumes the stopwatch.
	R	A signal at input R resets the elapsed time.
	Parameter	You can set a timebase <b>TB</b> for the stopwatch. <b>Possible timebase settings:</b> 10 ms, s, m, and h Retentivity: / = No retentivity R = The status is retentive
	Output AQ	A signal at input Lap holds the value of AQ until Lap is reset to 0. A signal at input R resets the value of AQ to 0.

#### Parameters TB

You can set a timebase from the following timebase set:

- 10 ms (10 milliseconds)
- s (seconds)
- m (minutes)
- h (hours)

### Timing diagram

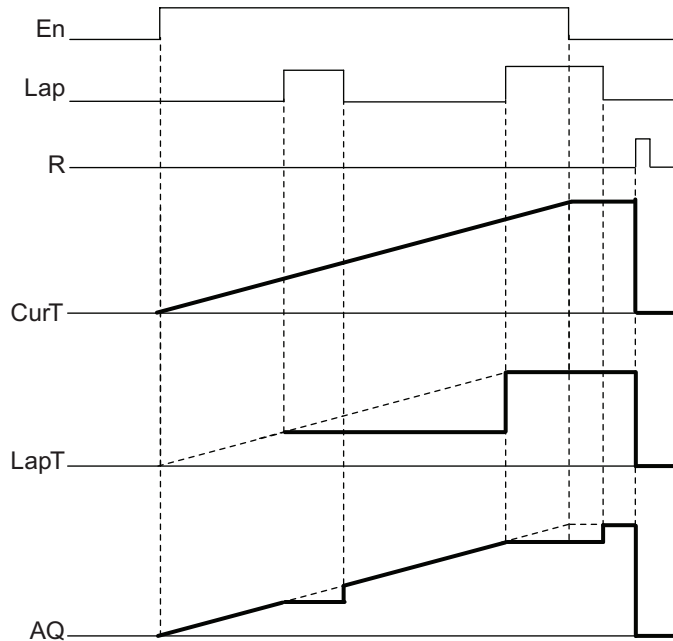

### Functional description

- En = 1 and Lap = 0: Using the selected timebase, the stopwatch outputs the current time (CurT) to AQ.
- En = 1 and Lap = 1: The stopwatch leaves AQ at its last value when Lap = 0. This value is recorded as LapT for stopwatch pause time.
- En = 0 and Lap = 1: The stopwatch pauses counting time. It outputs LapT to AQ.
- En = 0 and Lap = 0: The stopwatch outputs the current time (CurT) to AQ.
- A signal at R sets the AQ value to 0.

### Setting the Par parameter

View in programming mode (example):

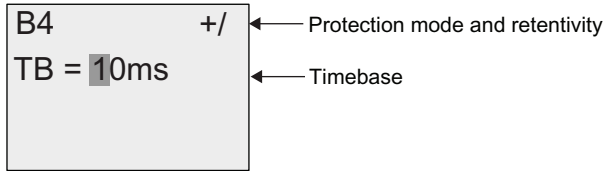

To change the timebase, press ► to move the cursor to "1". Press ▲ or ▼ to select another timebase. To confirm your selection, press **OK**.

Views in parameter assignment mode (example):

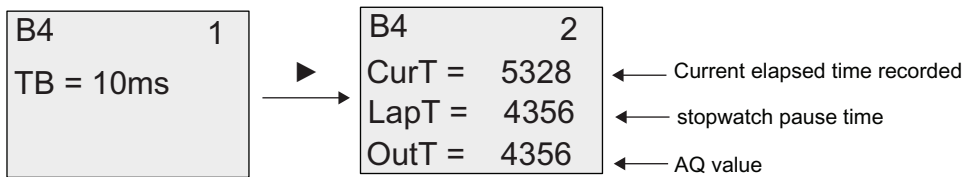

## 4.4.15 Up/down counter

### Short description

An input pulse increments or decrements an internal value, depending on the parameter setting. The output is set or reset when a configured threshold is reached. The direction of count can be changed with a signal at input Dir.

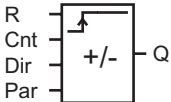
Symbol in LOGO!	Wiring	Description
	Input R	A signal at input R resets the internal count value to zero.
	Input Cnt	<p>The function counts the 0 to 1 transitions at input Cnt. 1 to 0 transitions are not counted.</p> <p>Use</p> <ul style="list-style-type: none"> <li>inputs I3, I4, I5, and I6 for fast counting (only LOGO! 12/24RC/RCo, LOGO! 12/24RCE, LOGO! 24/24o and LOGO! 24C/24Co): max. 5 kHz, if the fast input is directly connected to the up/down counter function block</li> <li>any other input or circuit component for counting low frequency signals (typ. 4 Hz).</li> </ul>
	Input Dir	<p>You set the direction of count at input Dir:</p> <p>Dir = 0: Count up Dir = 1: Count down</p>
	Parameter	<p>On: On threshold Range of values: 0...999999</p> <p>Off: Off threshold Range of values: 0...999999</p> <p>StartVal: Initial value from which to begin counting either down or up.</p> <p>Retentivity for internal counter value Cnt: / = No retentivity R = The status is retentive.</p>
	Output Q	Q is set or reset, depending on the current value at Cnt and the set thresholds.

### Parameters On and Off

The on threshold On and the off threshold Off can be provided by the actual value of another already-programmed function. You can use the actual values of the following functions:

- Analog comparator (Page 218) (actual value Ax – Ay)
- Analog threshold trigger (Page 213) (actual value Ax)
- Analog amplifier (Page 226) (actual value Ax)
- Analog multiplexer (Page 248) (actual value AQ)
- Analog ramp (Page 251) (actual value AQ)
- Mathematic instruction (Page 265) (actual value AQ)
- PI controller (Page 256) (actual value AQ)
- Up/down counter (actual value Cnt)

If your LOGO! is a LOGO! 0BA7, you can **additionally** use the actual values of the following functions:

- Analog filter (0BA7 only) (Page 271) (actual value AQ)
- Average value (0BA7 only) (Page 276) (actual value AQ)
- Max/Min (0BA7 only) (Page 273) (actual value AQ)
- On-delay (Page 160) (current time Ta)
- Off-delay (Page 164) (current time Ta)
- On-/off-delay (Page 166) (current time Ta)
- Retentive on-delay (Page 168) (current time Ta)
- Wiping relay(pulse output) (Page 170) (current time Ta)
- Edge triggered wiping relay (Page 172) (current time Ta)
- Asynchronous pulse generator (Page 175) (current time Ta)
- Stairway light switch (Page 179) (current time Ta)
- Multiple function switch (Page 182) (current time Ta)
- Stopwatch (Page 198) (actual value AQ)
- Threshold trigger (Page 210) (actual value Fre)

Select the required function by the block number.

### Timing diagram

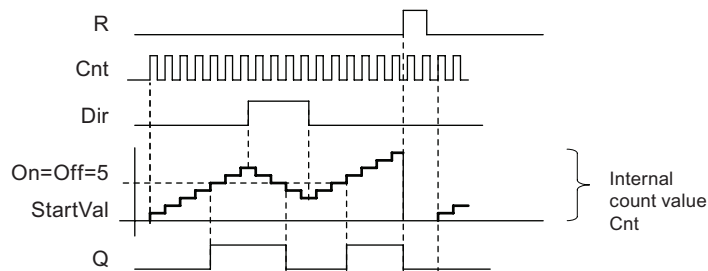

### Functional description

The internal counter increments (Dir = 0) or decrements (Dir = 1) by one count with every positive edge at input Cnt.

You can use input R to reset the internal count value to the start value. As long as R = 1, the output is also 0 and the pulses at input Cnt are not counted.

If retentivity is not set, output Q and the expired time are reset after a power failure.

Q is set or reset depending on the current value at Cnt and the set thresholds. See the calculation rule below.

### Calculation rule

- If the On threshold  $\geq$  Off threshold, then:  
 $Q = 1$ , if  $Cnt \geq On$   
 $Q = 0$ , if  $Cnt < Off$
- If the On threshold  $<$  Off threshold, then  $Q = 1$ , if  $On \leq Cnt < Off$ .

---

#### Note

The system scans the counter limit value cyclically.

Thus, if the pulse frequency at the fast digital inputs I3, I4, I5 or I6 is faster than the cycle time, the special function might not switch until after the specified limit value is exceeded.

Example: Up to 100 pulses per cycle can be counted; 900 pulses have been counted so far. On = 950; Off = 10000. The output is set in the next cycle, after the value has reached 1000. (The output would not be set at all if the value Off = 980).

---

View in programming mode (example):

```

B3  1+R
On =001234
Off=000000
```

or

```

B3  1+R
On =123456
Off→B021
```

To set the start value, press ▲ or ▼ to access the following screen form:

```
B3  2+R
STV =0100
```

If the referenced block (B021, in the example) returns a value that lies out of the valid range, the value is rounded to the next valid value.

The view in parameter assignment mode (example):

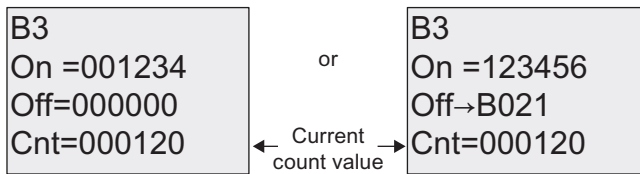



## 4.4.16 Hours counter

### Short description

A configured time is triggered with a signal at the monitoring input. The output is set when this time has expired.

Symbol in LOGO!	Wiring	Description
	Input R	A positive edge (0 to 1 transition) at input R resets output Q and sets a configured value MI at the counter for the duration of the time-to-go (MN).
	Input En	En is the monitoring input. LOGO! scans the on-time of this input.
	Input Ral	A positive edge at input Ral (Reset all) resets the hours counter (OT) and the output, and sets the time-to-go value (MN) to the maintenance interval MI: <ul style="list-style-type: none"> <li>• Output Q = 0</li> <li>• Measured operating time OT = 0</li> <li>• Time-to-go of the maintenance interval MN = MI.</li> </ul>
	Parameter	MI: Maintenance interval to be preset in units of hours and minutes Range of values: 0000...9999 h, 0...59 m OT: The accumulated total operating time; you can specify an offset in hours and minutes Range of values: 00000...99999 h, 0...59 m Q → 0: <ul style="list-style-type: none"> <li>• When "R" is selected: Q = 1, if MN = 0; Q = 0, if R = 1 or Ral = 1</li> <li>• When "R+En" is selected: Q = 1, if MN = 0; Q = 0, if R = 1 or Ral = 1 or En = 0.</li> </ul>
	Output Q	The output is set when the time-to-go MN = 0 (see timing diagram). The output is reset: <ul style="list-style-type: none"> <li>• When "Q→0:R+En", if R = 1 or Ral = 1 or En = 0</li> <li>• When "Q→0:R", if R = 1 or Ral = 1.</li> </ul>

MI = Configured time interval

MN = Time-to-go

OT = Total time expired since the last hi signal at input Ral

These values are always retentive!

## Parameter MI

The maintenance interval MI can be provided by the actual value of another already-programmed function. The timebase of the referenced value is "h" (for hours) only. You can use the actual values of the following functions:

- Analog comparator (Page 218) (actual value Ax – Ay)
- Analog threshold trigger (Page 213) (actual value Ax)
- Analog amplifier (Page 226) (actual value Ax)
- Analog multiplexer (Page 248) (actual value AQ)
- Analog ramp (Page 251) (actual value AQ)
- Mathematic instruction (Page 265) (actual value AQ)
- PI controller (Page 256) (actual value AQ)
- Up/down counter (Page 201) (actual value Cnt)

If your LOGO! is a LOGO! 0BA7, you can **additionally** use the actual values of the following functions:

- Analog filter (0BA7 only) (Page 271) (actual value AQ)
- Average value (0BA7 only) (Page 276) (actual value AQ)
- Max/Min (0BA7 only) (Page 273) (actual value AQ)
- On-delay (Page 160) (current time Ta)
- Off-delay (Page 164) (current time Ta)
- On-/off-delay (Page 166) (current time Ta)
- Retentive on-delay (Page 168) (current time Ta)
- Wiping relay(pulse output) (Page 170) (current time Ta)
- Edge triggered wiping relay (Page 172) (current time Ta)
- Asynchronous pulse generator (Page 175) (current time Ta)
- Stairway light switch (Page 179) (current time Ta)
- Multiple function switch (Page 182) (current time Ta)
- Stopwatch (Page 198) (current time Ta)

Select the required function by the block number.

## Timing diagram

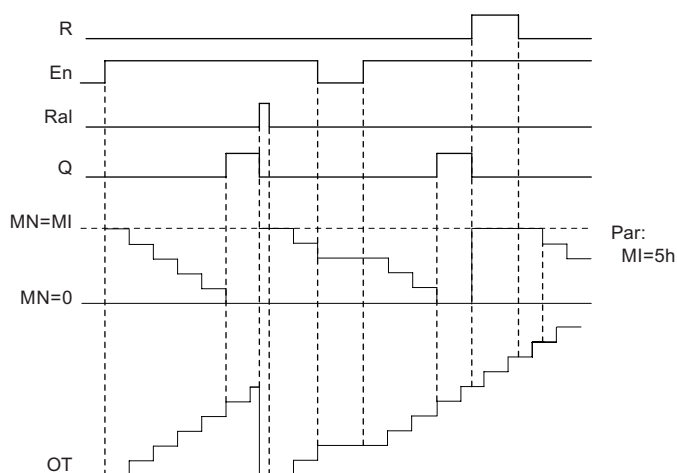

MI = Configured time interval  
MN = Time-to-go  
OT = Total time expired since the last hi signal at input Ral

## Functional description

The hours counter monitors input En. When En = 1, LOGO! computes the time expired and the time-to-go MN. LOGO! shows these times in parameter assignment mode. Output Q is set when the time-to-go MN = 0.

A signal at reset input R resets output Q and sets the preset value of MI at the counter for the duration of MN. The hours counter OT is not affected.

With a signal at the reset input Ral, you reset output Q and set the preset value of MI at the counter for the duration of MN. The hours counter OT is reset to zero.

Depending on your configuration of parameter Q, the output is either reset with a signal at input R or Ral ("Q→0:R"), or when a reset signal is set hi, or the En signal is set lo ("Q→0:R+En").

## Viewing the MI, MN and OT values

- LOGO! Basic: You can open the parameter assignment mode when the system is in RUN to view the actual values of MI, MN and OT.
- LOGO! Pure: In LOGO!Soft Comfort, you can use the Online Test to read these values. For further information, see chapter "LOGO! software (Page 313)".
- In LOGO!Soft Comfort you can get the hours counter via the "Tools -> Transfer: Hours counter" menu command.

**Limit value of OT**

The value of the operating hours in OT is retained when you reset the hours counter with a signal at input R. The hours counter OT will be reset to zero with a transition from 0 to 1 at Ra1. The hours counter OT continues the count as long as En = 1, irrespective of the status at the reset input R. The counter limit of OT is 99999 h. The hours counter stops when it reaches this value.

In programming mode, you can set the initial value of OT. MN is calculated according to the following formula when reset input R is never enabled:  $MN = MI - (OT \% MI)$ . The % operator provides an integer division remainder.

Example:

$MI = 30h, OT = 100h$

$MN = 30 - (100 \% 30)$

$MN = 30 - 10$

$MN = 20h$

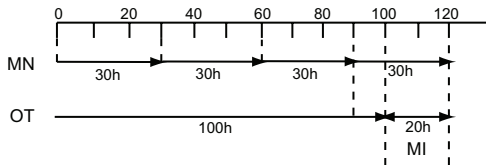

In runtime mode, the value OT can not be preset. If the value for MI is changed, there would be no calculation for the MN. MN would take on the value of MI.

**Setting the Par parameter**

View in programming mode:

```
B16 1+R
MI = 0100h
00 m
```

```
B16 1+R
MI → B001h
```

```
B16 2+R
OT = 00030h
00 m
```

```
B16 3+R
Q → 0:R+En
```

**MI** is the configurable time interval. The permissible range of values is 0 to 9999 hours.

For information on how to assign the actual value of another already-programmed function to a parameter, see the On-delay (Page 160) topic.

View in parameter assignment mode:

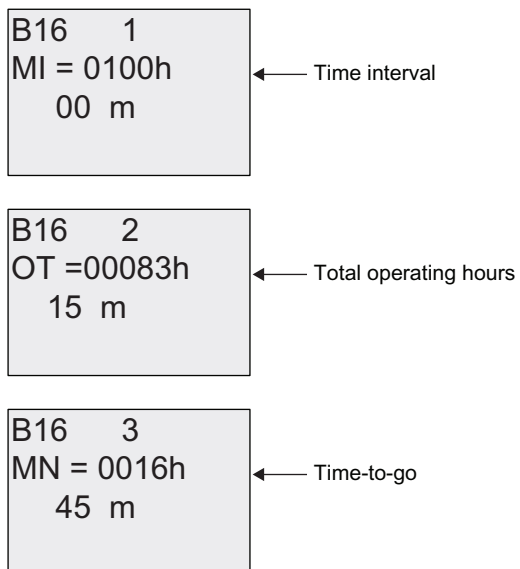

### 4.4.17 Threshold trigger

#### Short description

The output is set and reset with two configurable threshold triggers.

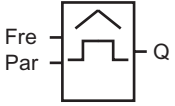
Symbol in LOGO!	Wiring	Description
	Input Fre	<p>The function counts the 0 to 1 transitions at input Fre. 1 to 0 transitions are not counted.</p> <p>Use</p> <ul style="list-style-type: none"> <li>inputs I3, I4, I5, I6 for fast counting (only LOGO! 12/24RC/RCo, LOGO! 12/24RCE, LOGO! 24/24o and LOGO! 24C/24Co): max. 5 kHz, if the fast input is directly connected to the threshold trigger function block</li> <li>any other input or circuit component for counting low frequency signals (typ. 4 Hz).</li> </ul>
	Parameter	<p>On: On threshold Range of values: 0000...9999</p> <p>Off: Off threshold Range of values: 0000...9999</p> <p>G_T: Time interval or gate time during which the input pulses are measured. Range of values: 00:00 s...99:99 s</p>
	Output Q	Q is set and reset at the thresholds.

#### Parameter G\_T

The gate time G\_T can be provided by the actual value of another already-programmed function. You can use the actual values of the following functions:

- Analog comparator (Page 218) (actual value Ax – Ay)
- Analog threshold trigger (Page 213) (actual value Ax)
- Analog amplifier (Page 226) (actual value Ax)
- Analog multiplexer (Page 248) (actual value AQ)
- Analog ramp (Page 251) (actual value AQ)
- Mathematic instruction (Page 265) (actual value AQ)
- PI controller (Page 256) (actual value AQ)
- Up/down counter (Page 201) (actual value Cnt)

If your LOGO! is a LOGO! 0BA7, you can **additionally** use the actual values of the following functions:

- Analog filter (0BA7 only) (Page 271) (actual value AQ)
- Average value (0BA7 only) (Page 276) (actual value AQ)
- Max/Min (0BA7 only) (Page 273) (actual value AQ)
- On-delay (Page 160) (current time Ta)
- Off-delay (Page 164) (current time Ta)
- On-/off-delay (Page 166) (current time Ta)
- Retentive on-delay (Page 168) (current time Ta)
- Wiping relay(pulse output) (Page 170) (current time Ta)
- Edge triggered wiping relay (Page 172) (current time Ta)
- Asynchronous pulse generator (Page 175) (current time Ta)
- Stairway light switch (Page 179) (current time Ta)
- Multiple function switch (Page 182) (current time Ta)
- Stopwatch (Page 198) (actual value AQ)
- Threshold trigger (actual value Fre)

Select the required function by the block number.

### Timing diagram

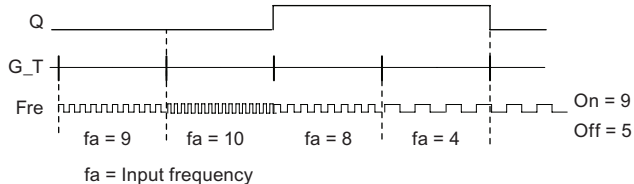

### Functional description

The threshold trigger measures the signals at input Fre. The pulses are recorded across a configurable time G\_T.

Output Q is set and reset in accordance with the set thresholds. See the calculation rule below.

**Calculation rule**

- If the On threshold  $\geq$  Off threshold, then:  
Q = 1, if  $f_a > \text{On}$   
Q = 0, if  $f_a \leq \text{Off}$ .
- If the On threshold  $<$  Off threshold, then Q = 1 if  
 $\text{On} \leq f_a < \text{Off}$ .

**Setting the Par parameter**

**Note**

The system scans the counter limit value once per interval G\_T.

View in programming mode (example):

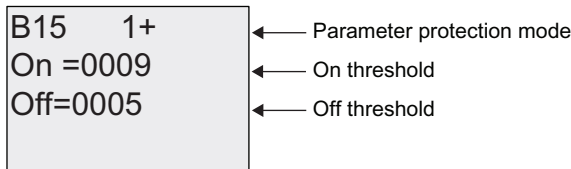

Press ►

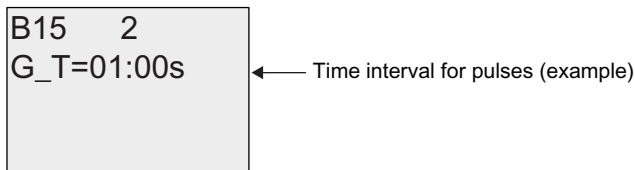

**Note**

The "seconds" timebase is here set as permanent default.

When you preset a time G\_T of 1 s, LOGO! returns the current frequency in parameter  $f_a$  in Hz.

View in parameter assignment mode (example):



**Note**

$f_a$  always represents the total pulses measured per time unit G\_T.



## 4.4.18 Analog threshold trigger

### Short description

The output is set and reset at two configurable thresholds.

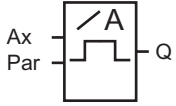
Symbol in LOGO!	Wiring	Description
	Input Ax	Input Ax is one of the following analog signals: <ul style="list-style-type: none"> <li>• AI1 to AI8 (*)</li> <li>• AM1 to AM6 (if 0BA6) or AM1 to AM16 (if 0BA7)</li> <li>• NAI1 to NAI32 (if 0BA7)</li> <li>• AQ1 to AQ2</li> <li>• NAQ1 to NAQ16 (if 0BA7)</li> <li>• Block number of a function with analog output</li> </ul>
	Parameter	A: Gain Range of values: $\pm 10.00$ B: Zero offset Range of values: $\pm 10,000$ On: On threshold Range of values: $\pm 20,000$ Off: Off threshold Range of values: $\pm 20,000$ p: Number of decimals Range of values: 0, 1, 2, 3
	Output Q	Q is set or reset by the threshold triggers.

\* AI1...AI8: 0...10 V corresponds with 0...1000 (internal value).

### Gain and offset parameters

Please note the information on gain and offset parameters in topic "Calculating the gain and offset of analog values (Page 154)".

### Parameters On and Off

The On and Off parameters can be provided by the actual value of another already-programmed function. You can use the actual values of the following functions:

- Analog comparator (Page 218) (actual value Ax – Ay)
- Analog amplifier (Page 226) (actual value Ax)
- Analog multiplexer (Page 248) (actual value AQ)
- Analog Ramp (Page 251) (actual value AQ)
- Mathematic instruction (Page 265) (actual value AQ)
- PI controller (Page 256) (actual value AQ)
- Up/down counter (Page 201) (actual value Cnt)

If your LOGO! is a LOGO! 0BA7, you can **additionally** use the actual values of the following functions:

- Analog filter (0BA7 only) (Page 271) (actual value AQ)
- Average value (0BA7 only) (Page 276) (actual value AQ)
- Max/Min (0BA7 only) (Page 273) (0BA7 only) (actual value AQ)
- On-delay (Page 160) (current time Ta)
- Off-delay (Page 164) (current time Ta)
- On-/Off-delay (Page 166) (current time Ta)
- Retentive on-delay (Page 168) (current time Ta)
- Wiping relay (pulse output) (Page 170) (current time Ta)
- Edge triggered wiping relay (Page 172) (current time Ta)
- Asynchronous pulse generator (Page 175) (current time Ta)
- Stairway lighting switch (Page 179) (current time Ta)
- Multiple function switch (Page 182) (current time Ta)
- Stopwatch (0BA7 only) (Page 198) (actual value AQ)
- Analog threshold trigger (actual value Ax)
- Threshold trigger (Page 210) (actual value Fre)

Select the required function by the block number.

**Parameter p (number of decimals)**

Applies only to the display of On, Off and Ax values in a message text.  
Does not apply to the comparison of On and Off values! (The compare function ignores the decimal point.)

**Timing diagram**

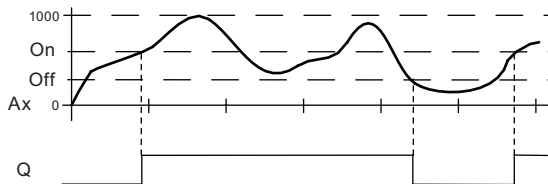

**Functional description**

The function fetches the analog signal at input Ax.

Ax is multiplied by the value of the A (gain) parameter, and the value at parameter B (offset) is added to product, i.e.  $(Ax \cdot gain) + offset = \text{actual value of Ax}$ .

Output Q is set or reset, depending on the set thresholds. See the calculation rule below.

### Calculation rule

- If the On threshold  $\geq$  Off threshold, then:  
 $Q = 1$ , if the actual value  $Ax > On$   
 $Q = 0$ , if the actual value  $Ax \leq Off$ .
- If the On threshold  $<$  Off threshold, then  $Q = 1$  if  
 $On \leq actual\ value\ Ax < Off$ .

### Setting the Par parameter

The gain and offset parameters are used to adapt the sensors to the relevant application.

View in programming mode (example):

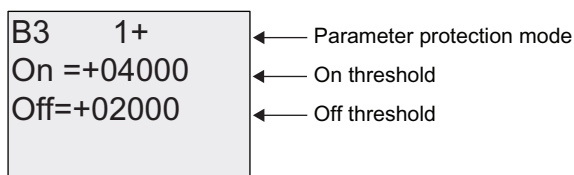

Press ►

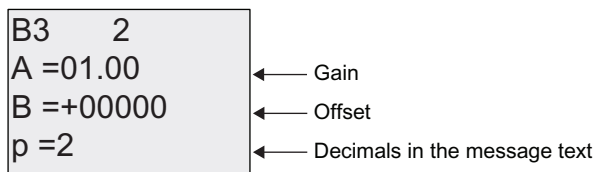

View in parameter assignment mode (example):

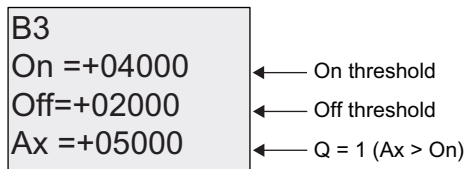

View in the message text (example):

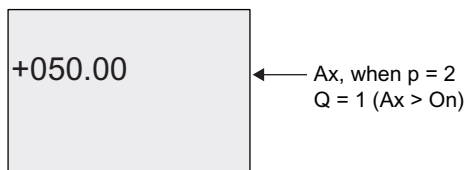

### 4.4.19 Analog differential trigger

#### Short description

The output is set and reset depending on a configurable threshold and a differential value.

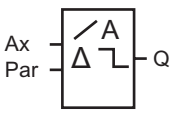
Symbol in LOGO!	Wiring	Description
	Input Ax	Input Ax is one of the following analog signals: <ul style="list-style-type: none"> <li>• AI1 to AI8 (*)</li> <li>• AM1 to AM6 (if 0BA6) or AM1 to AM16 (if 0BA7)</li> <li>• NAI1 to NAI32 (if 0BA7)</li> <li>• AQ1 to AQ2</li> <li>• NAQ1 to NAQ16 (if 0BA7)</li> <li>• Block number of a function with analog output</li> </ul>
	Parameter	A: Gain Range of values: ±10.00 B: Zero offset Range of values: ±10,000 On: On/Off threshold Range of values: ±20,000 Δ: Differential value for calculating the off parameter Range of values: ±20,000 p: Number of decimals Range of values: 0, 1, 2, 3
	Output Q	Q is set or reset, depending on the threshold and difference values.
* AI1...AI8: 0...10 V corresponds with 0...1000 (internal value).		

#### Gain and offset parameters

Please note the information on gain and offset parameters in topic "Calculating the gain and offset of analog values (Page 154)".

#### Parameter p (number of decimals)

Applies only to the display of On, Off and Ax values in a message text.

#### Timing diagram A: Function with negative difference Δ

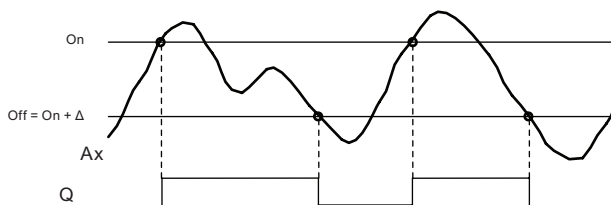

### Timing diagram B: Function with positive difference $\Delta$

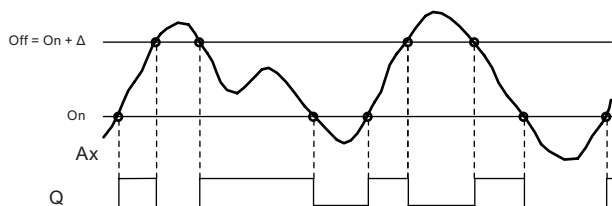

### Functional description

The function fetches the analog signal at input  $A_x$ .

$A_x$  is multiplied by the value of the A (gain) parameter, and the value at parameter B (offset) is added to product, i.e.  $(A_x \cdot \text{gain}) + \text{offset} = \text{actual value of } A_x$ .

Output  $Q$  is set or reset, depending on the set (On) threshold and difference value ( $\Delta$ ). The function automatically calculates the Off parameter:  $\text{Off} = \text{On} + \Delta$ , whereby  $\Delta$  may be positive or negative. See the calculation rule below.

### Calculation rule

- When you set a negative differential value  $\Delta$ , the On threshold  $\geq$  Off threshold, and:
  - $Q = 1$ , if the actual value  $A_x > \text{On}$
  - $Q = 0$ , if the actual value  $A_x \leq \text{Off}$ .
  - See the timing diagram A.
- When you set a positive differential value  $\Delta$ , the On threshold  $<$  the Off threshold, and  $Q = 1$ , if:
  - $\text{On} \leq \text{actual value } A_x < \text{Off}$ .
  - See the timing diagram B.

### Setting the Par parameter

The gain and offset parameters are used to adapt the sensors to the relevant application.

View in programming mode (example):

B3 1+ On =+04000 $\Delta$ =-02000	← Parameter protection mode ← On/off threshold ← Differential value for the on/off threshold
---	--

Press ►

B3 2 A =01.00 B =+00000 p =2	← Gain ← Offset ← Decimals in the message text
---------------------------------------	--

View in parameter assignment mode (example):

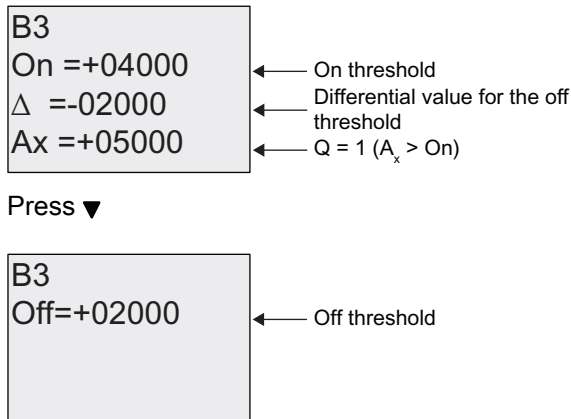

### 4.4.20 Analog comparator

#### Short description

The output is set and reset depending on the difference  $A_x - A_y$  and on two configurable thresholds.

Symbol in LOGO!	Wiring	Description
	Inputs $A_x$ and $A_y$	Inputs $A_x$ and $A_y$ are one of the following analog signals: <ul style="list-style-type: none"> <li>• AI1 to AI8 (*)</li> <li>• AM1 to AM6 (if 0BA6) or AM1 to AM16 (if 0BA7)</li> <li>• NAI1 to NAI32 (if 0BA7)</li> <li>• AQ1 to AQ2</li> <li>• NAQ1 to NAQ16 (if 0BA7)</li> <li>• Block number of a function with analog output</li> </ul>
	Parameter	A: Gain Range of values: $\pm 10.00$ B: Zero offset Range of values: $\pm 10,000$ On: On threshold Range of values: $\pm 20,000$ Off: Off threshold Range of values: $\pm 20,000$ p: Number of decimals Range of values: 0, 1, 2, 3
	Output Q	Q is set or reset, depending on the difference $A_x - A_y$ and the set thresholds..
* AI1...AI8: 0...10 V corresponds with 0...1000 (internal value).		

## Gain and offset parameters

For more information on the gain and offset parameters, refer to topic "Calculating the gain and offset of analog values (Page 154)".

## Parameters On and Off

The on threshold On and the off threshold Off can be provided by the actual value of another already-programmed function. You can use the actual values of the following functions:

- Analog threshold trigger (Page 213) (actual value Ax)
- Analog amplifier (Page 226) (actual value Ax)
- Analog multiplexer (Page 248) (actual value AQ)
- Analog ramp (Page 251) (actual value AQ)
- Mathematic instruction (Page 265) (actual value AQ)
- PI controller (Page 256) (actual value AQ)
- Up/down counter (Page 201) (actual value Cnt)

If your LOGO! is a LOGO! 0BA7, you can **additionally** use the actual values of the following functions:

- Analog filter (0BA7 only) (Page 271) (actual value AQ)
- Average value (0BA7 only) (Page 276) (actual value AQ)
- Max/Min (0BA7 only) (Page 273) (actual value AQ)
- On-delay (Page 160) (current time Ta)
- Off-delay (Page 164) (current time Ta)
- On-/Off-delay (Page 166) (current time Ta)
- Retentive on-delay (Page 168) (current time Ta)
- Wiping relay (pulse output) (Page 170) (current time Ta)
- Edge triggered wiping relay (Page 172) (current time Ta)
- Asynchronous pulse generator (Page 175) (current time Ta)
- Stairway lighting switch (Page 179) (current time Ta)
- Multiple function switch (Page 182) (current time Ta)
- Stopwatch (0BA7 only) (Page 198) (actual value AQ)
- Analog comparator (actual value Ax - Ay)
- Threshold trigger (Page 210) (actual value Fre)

Select the required function by the block number.

**Parameter p (number of decimals)**

Applies only to Ax, Ay, On, Off and Δ values displayed in a message text.  
 Does not apply to the comparison of on and off values! (The compare function ignores the decimal point.)

**Timing diagram**

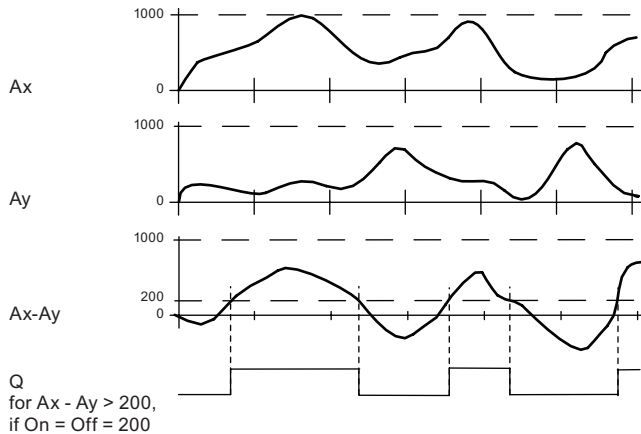

**Functional description**

The function fetches the analog values from the inputs Ax and Ay.

Ax and Ay are each multiplied by the value of the A (gain) parameter, and the value at parameter B (offset) is then added to the relevant product, i.e.

$$(Ax \cdot \text{gain}) + \text{offset} = \text{actual value Ax or}$$

$$(Ay \cdot \text{gain}) + \text{offset} = \text{actual value Ay.}$$

The function forms the difference ("Δ") between the actual values Ax - Ay.

Output Q is set or reset, depending on difference of the actual values Ax - Ay and the set thresholds. See the calculation rule below.

**Calculation rule**

- If the On threshold  $\geq$  Off threshold, then:  
 Q = 1, if:  
 $(\text{actual value Ax} - \text{actual value Ay}) > \text{On}$   
 Q = 0, if:  
 $(\text{actual value Ax} - \text{actual value Ay}) \leq \text{Off}.$
- If the On threshold  $<$  Off threshold, then Q = 1, if:  
 $\text{On} \leq (\text{actual value Ax} - \text{actual value Ay}) < \text{Off}.$



## Setting the Par parameter

The gain and offset parameters are used to adapt the sensors to the relevant application.

View in programming mode:

B3 1+	← Parameter protection mode
On =+00000	← On threshold
Off=+00000	← Off threshold

Press ►

B3 2	
A =00.00	← Gain
B =+00000	← Offset
p =0	← Decimals in the message text

## Example

In a heating control system, the supply  $T_v$  and return line temperatures  $T_r$  are to be compared, for example with a sensor at AI2.

A control signal is to be triggered (for example "heater On") when the difference between the supply and return line temperatures is greater than 15 °C. The control signal is reset when the difference is less than 5 °C.

The process variable of the temperature is to be shown in parameter assignment mode.

The thermocouples available have the following technical data: -30 to +70 °C, 0 to 10 VDC.

Application	Internal mapping
-30 to +70 °C = 0 to 10 V DC	0 to 1000
0 °C	300 → Offset = -30
Range of values: -30 to +70 °C = 100	1000 → Gain = 100/1000 = 0.1
On threshold = 15 °C	Threshold = 15
Off threshold = 5 °C	Threshold = 5
See also topic "Calculating the gain and offset of analog values (Page 154) ".	

Configuration (example):

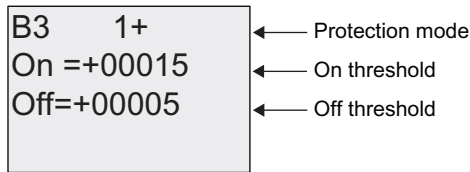

Press ►

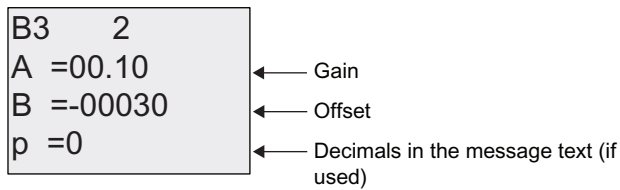

View in parameter assignment mode (example):

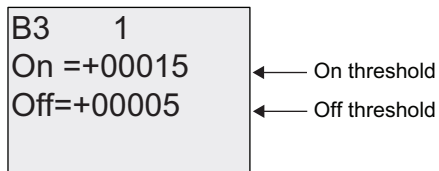

Press ▼

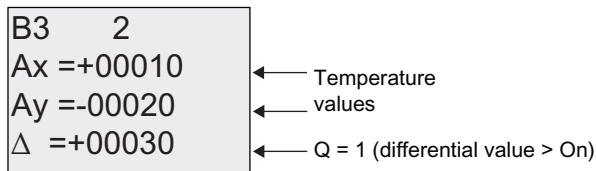

View in the message text (example):

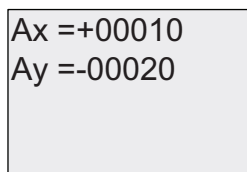

### Reducing the input response of the analog comparator

You can selectively delay the output of an analog comparator by means of the "On-delay" and "Off-delay" special functions. With on-delay, output Q is only set if the pulse width of the triggering signal at input Trg (=analog comparator output) is longer than the on-delay time.

Using this method, you will obtain a virtual hysteresis and reduce the input response to short signals.

Function block diagram

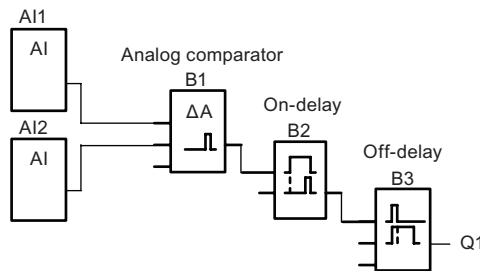

4.4.21 Analog watchdog

Short description

This special function saves the process variable of an analog input to memory, and sets the output when the output variable exceeds or drops below this stored value plus a configurable offset.

Symbol in LOGO!	Wiring	Description
	Input En	A positive edge (0 to 1 transition) at input En saves the analog value at input Ax ("Aen") to memory and starts monitoring of the analog range $A_{en} - \Delta_2$ to $A_{en} + \Delta_1$
	Input Ax	Input Ax is one of the following analog signals: <ul style="list-style-type: none"> <li>• AI1 to AI8 (*)</li> <li>• AM1 to AM6 (if 0BA6) or AM1 to AM16 (if 0BA7)</li> <li>• NAI1 to NAI32 (if 0BA7)</li> <li>• AQ1 to AQ2</li> <li>• NAQ1 to NAQ16 (if 0BA7)</li> <li>• Block number of a function with analog output</li> </ul>
	Parameter	A: Gain Range of values: $\pm 10.00$ B: Zero offset Range of values: $\pm 10,000$ $\Delta_1$ : Difference value above Aen: on/off threshold Range of values: 0-20,000 $\Delta_2$ : Difference value below Aen: on/off threshold Range of values: 0-20,000 p: Number of decimals Range of values: 0, 1, 2, 3 Retentivity: / = No retentivity R = The status is retentive in memory
	Output Q	Q is set/reset, depending on the stored analog value and the offset.
* AI1...AI8: 0...10 V corresponds with 0...1000 (internal value).		

## Gain and offset parameters

For more information on gain and offset parameters, refer to topic "Calculating the gain and offset of analog values (Page 154)".

## Parameters Delta1 and Delta2

The Delta1 and Delta2 parameters can be provided by the actual value of another already-programmed function. You can use the actual value of the following functions:

- Analog comparator (Page 218) (actual value Ax – Ay)
- Analog threshold trigger (Page 213) (actual value Ax)
- Analog amplifier (Page 226) (actual value Ax)
- Analog multiplexer (Page 248) (actual value AQ)
- Analog ramp (Page 251) (actual value AQ)
- Mathematic instruction (Page 265) (actual value AQ)
- PI controller (Page 256) (actual value AQ)
- Up/down counter (Page 201) (actual value Cnt)

If your LOGO! is a LOGO! 0BA7, you can **additionally** use the actual values of the following functions:

- Analog filter (0BA7 only) (Page 271) (actual value AQ)
- Average value (0BA7 only) (Page 276) (actual value AQ)
- Max/Min (0BA7 only) (Page 273) (actual value AQ)
- On-delay (Page 160) (current time Ta)
- Off-delay (Page 164) (current time Ta)
- On-/Off-delay (Page 166) (current time Ta)
- Retentive on-delay (Page 168) (current time Ta)
- Wiping relay (pulse output) (Page 170) (current time Ta)
- Edge triggered wiping relay (Page 172) (current time Ta)
- Asynchronous pulse generator (Page 175) (current time Ta)
- Stairway lighting switch (Page 179) (current time Ta)
- Multiple function switch (Page 182) (current time Ta)
- Stopwatch (0BA7 only) (Page 198) (actual value AQ)
- Threshold trigger (Page 210) (actual value Fre)

Select the required function by the block number.

**Parameter p (number of decimals)**

Applies only to the Aen, Ax,  $\Delta_1$  and  $\Delta_2$  values displayed in a message text.

**Timing diagram**

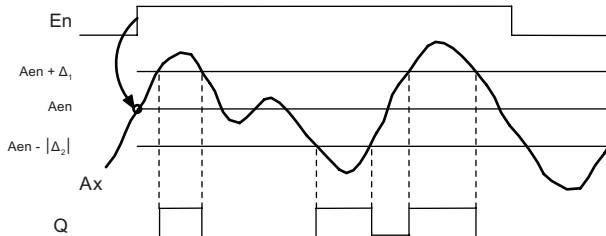

**Functional description**

A 0 to 1 transition at input En saves the value of the signal at the analog input Ax. This saved process variable is referred to as "Aen".

Both the analog actual values Ax and Aen are multiplied by the value at parameter A (gain), and parameter B (offset) is then added to the product:

$$(Ax \cdot \text{gain}) + \text{offset} = \text{Actual value Aen, when input En changes from 0 to 1, or}$$

$$(Ax \cdot \text{gain}) + \text{offset} = \text{Actual value Ax.}$$

Output Q is set when the signal at input En = 1 and if the actual value at input Ax is out of range of  $Aen - \Delta_2$  to  $Aen + \Delta_1$ .

Output Q is reset, when the actual value at input Ax lies within the range of  $Aen - \Delta_2$  to  $Aen + \Delta_1$ , or when the signal at input En changes to lo.

**Setting the Par parameter**

The gain and offset parameters are used to adapt the used sensors to the respective application.

View in programming mode:

<pre>B3  1+ Δ1 = 00000 Δ2 = 00000</pre>	<p>← Parameter protection mode</p> <p>← Differential value for the on/off threshold</p>
---	---

Press ►

<pre>B3  2 A =00.00 B =+00000 p =0</pre>	<p>← Gain</p> <p>← Offset</p> <p>← Decimals in the message text</p>
--	---

View in parameter assignment mode (example):

B3  
 $\Delta 1 = 00010$   
 $A_{en} = -00020$   
 $A_x = +00005$

← Q = 1 ( $A_x$  is out of the range of  $A_{en} - \Delta 2$  to  $A_{en} + \Delta 1$ )

B3  
 $\Delta 2 = 00010$

### 4.4.22 Analog amplifier

#### Short description

This special function amplifies the value of an analog input and outputs the result at an analog output.

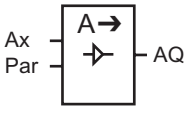
Symbol in LOGO!	Wiring	Description
	Input Ax	Input Ax is one of the following analog signals: <ul style="list-style-type: none"> <li>• AI1 to AI8 (*)</li> <li>• AM1 to AM6 (if 0BA6) or AM1 to AM16 (if 0BA7)</li> <li>• NAI1 to NAI32 (if 0BA7)</li> <li>• AQ1 to AQ2</li> <li>• NAQ1 to NAQ16 (if 0BA7)</li> <li>• Block number of a function with analog output</li> </ul>
	Parameter	A: Gain Range of values: $\pm 10.00$ B: Zero offset Range of values: $\pm 10,000$ p: Number of decimals Range of values: 0, 1, 2, 3
	Output AQ	This special function has an analog output! This output can only be connected with the analog input of a function, an analog flag or an analog output connector (AQ1, AQ2). Range of values for AQ: $-32767 \dots +32767$
* AI1...AI8: 0...10 V corresponds with 0...1000 (internal value).		

## Gain and offset parameters

Please note the information on gain and offset parameters in topic Calculating the gain and offset of analog values (Page 154).

## Parameter p (number of decimals)

Applies only to the AQ value in a message text.

## Functional description

The function fetches the analog signal of input Ax.

This value is multiplied by the value of the A (gain) parameter, and parameter B (offset) is then added to the product:  $(Ax \cdot \text{gain}) + \text{offset} = \text{actual value Ax}$ .

The actual value Ax is output at AQ.

## Analog output

If you interconnect this special function with a real analog output, note that the analog output can only process values between 0 and 1000. To do this, you may need to connect an additional amplifier between the analog output of the special function and the real analog output. Using this amplifier, you standardize the output range of the special function to a value range of 0 to 1000.

## Scaling an analog input value

You can influence the analog input value of a potentiometer by interconnecting an analog input with an analog amplifier and an analog flag.

- Scale the analog value at the analog amplifier for further use.
- Connect, for example, the time base for parameter T of a time function (e.g. On-/Off-delay (Page 166)) or the on and/or off limit specification of an up/down counter (Page 201) to the scaled analog value.

For more information with programming examples refer to the online help for LOGO!Soft Comfort.

## Setting the Par parameter

The gain and offset parameters are used to adapt the sensors to the relevant application.

View in programming mode (example):

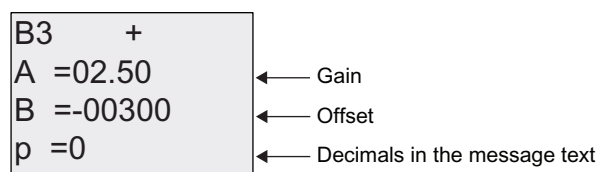

View in parameter assignment mode (example):

```
B3
A =02.50
B =-00300
AQ =-00250
```

### 4.4.23 Latching relay

#### Short description

Input S sets output Q, input R resets output Q again.

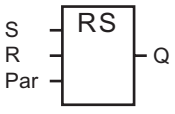
Symbol in LOGO!	Wiring	Description
	Input S	You set output Q with a signal at input S.
	Input R	You reset output Q with a signal at input R. If S and R = 1, the output is reset.
	Parameter	Retentivity: / = No retentivity R = The status is retentive.
	Output Q	Q is set with a signal at input S, and reset with a signal at input R.

#### Timing diagram

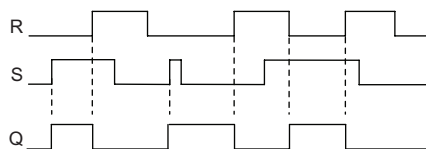

#### Switching response

A latching relay represents a simple binary element. The output value depends on the status at the inputs and on the previous output status. The following table shows the logic once again:

S <sub>n</sub>	R <sub>n</sub>	Q	Comment
0	0	x	The status is retentive
0	1	0	Reset
1	0	1	Set
1	1	0	Reset (takes priority over Set)

When retentivity is enabled, the current status of the output signal is retained after a power failure.



## 4.4.24 Pulse relay

### Short description

A short pulse at the input sets and resets the output.

Symbol in LOGO!	Wiring	Description
	Input Trg	You set and reset output Q with a signal at input Trg (Trigger).
	Input S	You set output Q with a signal at input S.
	Input R	You reset output Q with a signal at input R.
	Parameter	Selection: RS (R input priority) or SR (S input priority)  Retentivity: / = No retentivity R = The status is retentive.
	Output Q	Q is set with a signal at Trg, and reset with the next signal at Trg, if S and R = 0.

### Timing diagram

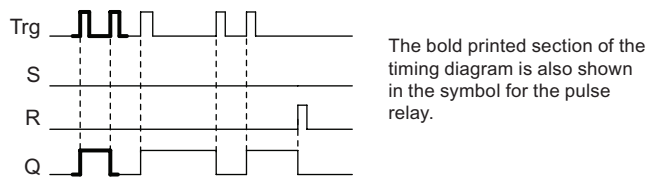

### Functional description

Output Q changes its status; that is, the output is set or reset with each 0 to 1 transition at input Trg and if the inputs S and R = 0.

The signal at input Trg does not influence the special function when S or R = 1.

You set the pulse relay with a signal at input S. The output is set hi.

You reset the pulse relay with a signal at input R. The output is set lo.

Status diagram

Par	Q <sub>n-1</sub>	S	R	Trg	Q <sub>n</sub>
*	0	0	0	0	0
*	0	0	0	0 ->1	1**
*	0	0	1	0	0
*	0	0	1	0 ->1	0
*	0	1	0	0	1
*	0	1	0	0 ->1	1
RS	0	1	1	0	0
RS	0	1	1	0 ->1	0
SR	0	1	1	0	1
SR	0	1	1	0 ->1	1
*	1	0	0	0	1
*	1	0	0	0 ->1	0**
*	1	0	1	0	0
*	1	0	1	0 ->1	0
*	1	1	0	0	1
*	1	1	0	0 ->1	1
RS	1	1	1	0	0
RS	1	1	1	0 ->1	0
SR	1	1	1	0	1
SR	1	1	1	0 ->1	1

\*: RS or SR

\*\* : Triggering signal is effective, because S and R = 0.

Depending on your configuration, either input R takes priority over input S (input S is not effective when R = 1), or vice versa (input R is not effective when S = 1).

After a power failure, the pulse relay and output Q are reset if you have not enabled retentivity.

View in programming mode:

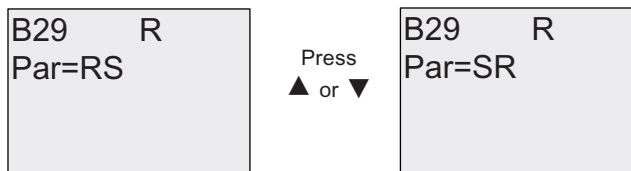

This special function is not available in parameter assignment mode.

**Note**

If Trg = 0 and Par = RS, the special function "Pulse relay" corresponds with the special function "Latching relay (Page 228)".

## 4.4.25 Message texts

### Short description

With the message text function block, you can configure a message that includes text and other parameters for LOGO! to display in RUN mode.

You can configure simple message texts from the LOGO! onboard display. LOGO!Soft Comfort provides an extended set of features for message texts: bar graph representation of data, names for digital I/O states and more. Refer to the LOGO!Soft Comfort documentation for information on these features.

### Global Message Text Settings

You configure global parameters that apply to all message texts from the Msg Config selections on the Programming menu:

- **Analog Time:** refresh rate in milliseconds that specifies how frequently analog inputs in message texts are updated
- **Tick time:** frequency at which message texts scroll on and off the display  
There are two ways that a message text can tick on and off the screen: line by line, or character by character, which are described in more detail below. A line of a text message, or each character of a text message in turn will tick on and off the LOGO! onboard display based on the tick time. For a message that ticks line by line, the actual tick time is ten times the configured tick time. For messages that tick character by character, the actual tick time is the configured tick time.
- **CharSets:** The primary and secondary character sets from which you can configure message texts. CharSet1 and CharSet2 can be any of the supported character sets for LOGO!:

Character Set in LOGO!	Common Name	Supports Languages	Internet Reference
ISO8859-1	Latin-1	English, German, Italian, Spanish (partly), Dutch (partly)	<a href="http://en.wikipedia.org/wiki/ISO/IEC_8859-1">http://en.wikipedia.org/wiki/ISO/IEC_8859-1</a>
ISO8859-5	Cyrillic	Russian	<a href="http://en.wikipedia.org/wiki/ISO/IEC_8859-5">http://en.wikipedia.org/wiki/ISO/IEC_8859-5</a>
ISO8859-9	Latin-5	Turkish	<a href="http://en.wikipedia.org/wiki/ISO/IEC_8859-9">http://en.wikipedia.org/wiki/ISO/IEC_8859-9</a>
ISO8859-16	Latin-10	French	<a href="http://en.wikipedia.org/wiki/ISO/IEC_8859-16">http://en.wikipedia.org/wiki/ISO/IEC_8859-16</a>
GB-2312	Chinese	Chinese	<a href="http://en.wikipedia.org/wiki/GB2312">http://en.wikipedia.org/wiki/GB2312</a>
Shift-JIS	Japanese	Japanese	<a href="http://en.wikipedia.org/wiki/Shift-jis">http://en.wikipedia.org/wiki/Shift-jis</a>

- Current Character Set: which character set is selected for the display of message texts

---

**Note**

Message texts supported by LOGO! 0BA5 will display on the LOGO! TD only when the following conditions are met:

- CharSet1 is selected and set to ISO8859-1
  - Current Character Set "CurrCharSet" is set to CharSet1
- 

Of the fifty possible message texts that you can configure, you can select any number of them to be from the first language and any number from the second language. For example, you could configure fifty message text function blocks that have a single message text for Character Set 1. Alternatively, you could configure twenty-five message text function blocks, each of which has two message texts: one for Character Set 1 and one for Character Set 2. Any combination is valid such that the total does not exceed fifty.

Within a single message text, the text must be from one character set. You can edit message texts in any of the supported character sets from LOGO!Soft Comfort. From the LOGO! Basic, you can only edit text using characters from the ISO8859-1 character set.

The language and therefore character set of a message text is independent of the language setting for menus on the LOGO! onboard display. They can be different.

## Chinese Character Set

The LOGO! Basic and LOGO! TD support the Chinese character set (GB-2312) for the People's Republic of China. The devices use Microsoft Windows encoding for this character set. The Windows encoding allows the devices to display the same characters as shown in the LOGO!Soft Comfort message text editor when you are using a Chinese emulator or a Chinese version of Microsoft Windows.

The Chinese character set requires a Chinese version of Windows or a Chinese emulator to properly display Chinese characters in the LOGO!Soft Comfort message text editor. You must start the Chinese emulator before you open the the message text function block in LOGO!Soft Comfort.

### Programming Global Message Text Parameters

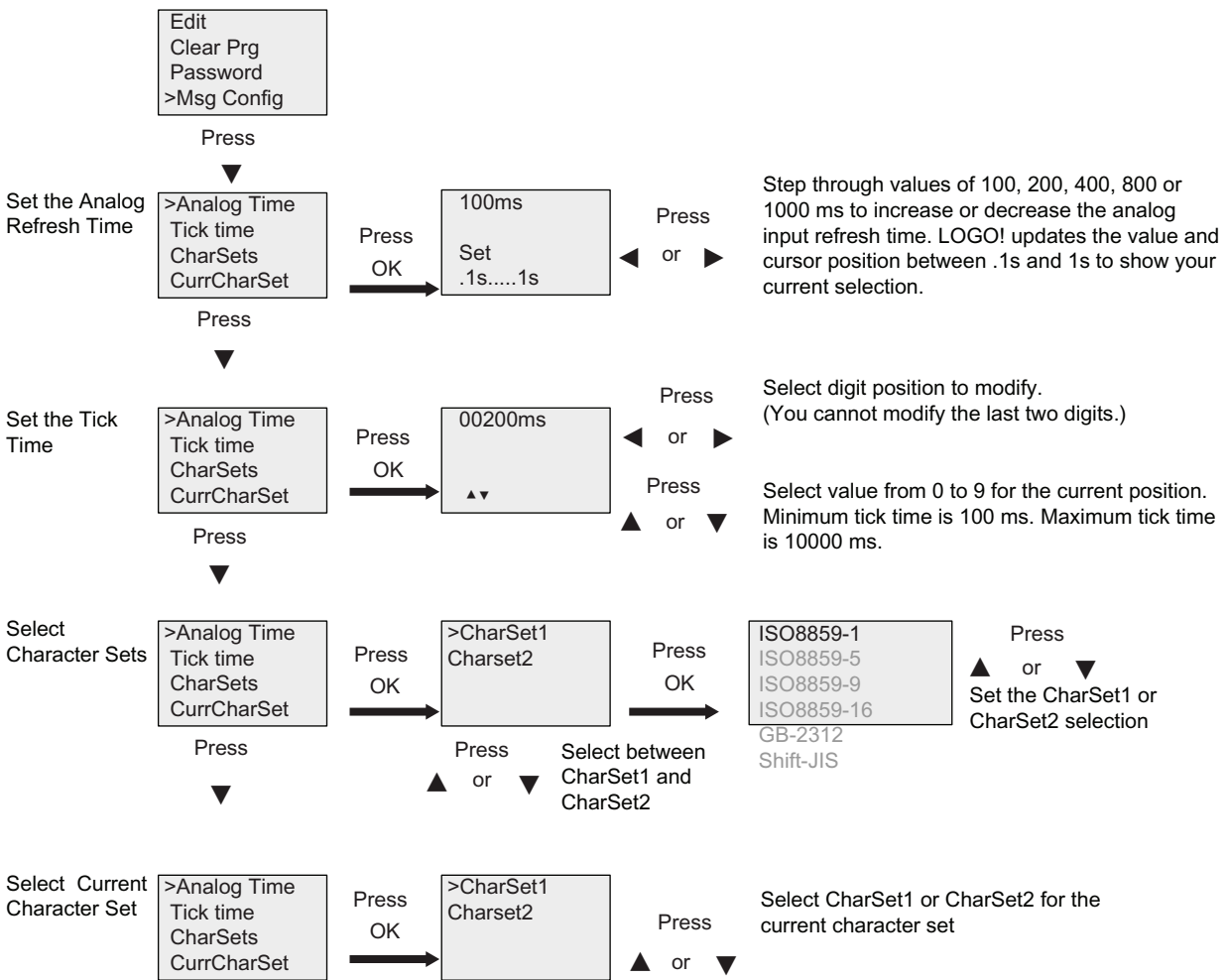

### Message Text Function Block

Symbol in LOGO!	Wiring	Description
	Input En	A 0 to 1 transition at input En (Enable) starts the output of the message text.
	Input P	P: Priority of the message text Range of values: 0...127 Message destination Message tick settings Ack: Acknowledgment of the message text

Symbol in LOGO!	Wiring	Description
	Parameter	<p>Text: Input of the message text</p> <p>Par: Parameter or actual value of another already-programmed function (see "Visible parameters or process variables")</p> <p>Time: Display of the continuously updated time-of-day</p> <p>Date: Display of the continuously updated date</p> <p>EnTime: Display of the time of the 0 to 1 transition of the signal at input En</p> <p>EnDate: Display of the date of the 0 to 1 transition of the signal at input En</p> <p>I/O status names:</p> <p>If your LOGO! is a LOGO! 0BA6, it can display a digital input or output status name, for example "On" or "Off" on 0BA6.</p> <p>If your LOGO! is a LOGO! 0BA7, it can display the status names of the following elements:</p> <ul style="list-style-type: none"> <li>• Digital inputs</li> <li>• Digital outputs</li> <li>• Flags</li> <li>• Cursor keys</li> <li>• LOGO! TD function keys</li> <li>• Shift register bits</li> <li>• Function block outputs</li> </ul> <p>Analog Input: Display of an analog input value to be shown in message text and updated according to the analog time.</p> <p>Scale time (0BA7 only): Display of the actual value of a referenced function block as a time value scaled based on the timebase configured for the message text function block. Possible time display formats are as shown below:</p> <ul style="list-style-type: none"> <li>• hours : minutes : seconds . milliseconds</li> <li>• hours : minutes : seconds</li> <li>• hours : minutes</li> <li>• hours</li> </ul> <p>(for example, "01: 20 : 15 .15")</p> <p>Symbol (0BA7 only): Display of characters selected from the supported character sets.</p> <p><b>Note:</b> You can only edit the Text parameter of the message from the LOGO! Basic. ISO8859-1 is the only available character set for editing text. You can edit all other parameters, and other languages for the Text parameter from LOGO!Soft Comfort. See the online help for configuration details.</p>
	Output Q	Q remains set as long as the message text is set.

## Restriction

A maximum of 50 message texts are available.

## Functional description

When LOGO! is in RUN mode, LOGO! displays the message text that you have configured along with its parameter values upon a 0 to 1 transition of the signal at input En.

Based on your setting for the message destination, the message text displays on the LOGO! onboard display, the LOGO! TD, or both.

If you use flag M27 in your circuit program, then if M27=0 (low) then LOGO! displays the message text only if it is from the primary character set (Character Set 1). If M27=1 (high), then LOGO! displays the message text only if it is from the secondary character set (Character Set 2). (See the M27 flag description in topic Constants and connectors - Co (Page 138)).

If you have configured message ticking, the message will tick on and off the display according to your specifications, either a character at a time, or a line at a time.

If acknowledgment is disabled (Ack = Off), the message text is hidden when the status of the signal at input En changes from 1 to 0.

If acknowledgment is enabled (Ack = On) and the status of the signal at input En changes from 1 to 0, the message text is output until it is acknowledged with **OK**. When En = 1, you cannot acknowledge the message text.

When multiple message text functions are triggered with En=1, LOGO! displays the message text with the highest priority (0 = lowest, 127 = highest). This also means that LOGO! displays a newly activated message text only if its priority is higher than that of previously activated message texts.

After a message text is disabled or acknowledged, the function automatically shows the previously active message text that takes the highest priority.

You can press the ▲ and ▼ keys to step through multiple active message texts.

### Example

This is how two message texts could be shown:

Display field of LOGO! in RUN mode

```
Motor 5
STOP AT
10:12
!!Action!!
```

Example: Message text with priority 30

Press



```
Motor 2
3000
hours
MAINTENANCE!
```

Example: Message text with priority 10

Press



```
Mo 09:00
2003-01-27
```

Date and current time-of-day (only for versions with real-time clock).

### Message Ticking

You can configure message text lines to tick or not tick. Two types of message ticking exist:

- Character by character
- Line by line

Messages that tick character by character scroll off the characters of the message line one character at a time to the left with the additional characters scrolling in one at a time from the right. The time interval for the tick is specified by the TickTime message text setting.

Messages that tick line by line by line scroll one half of the message off the display to the left with the second half of the message scrolling in from the right. The time interval for the tick is ten times the TickTime parameter. The two halves of the message simply alternate on the LOGO! onboard display or LOGO! TD.



**Example: Tick Message Character by Character**

The following illustration shows a one-line, 24-character message text:

X1	X2	X3	X4	X5	X6	X7	X8	X9	X10	X11	X12	X13	X14	X15	X16	X17	X18	X19	X20	X21	X22	X23	X24

If you set this message to tick "character by character" with a tick interval of 0.1 seconds, then the initial appearance of this message line on the LOGO! onboard display or LOGO! TD is as shown in this illustration:

X1	X2	X3	X4	X5	X6	X7	X8	X9	X10	X11	X12	X13	X14	X15	X16	X17	X18	X19	X20	X21	X22	X23	X24
----	----	----	----	----	----	----	----	----	-----	-----	-----	-----	-----	-----	-----	-----	-----	-----	-----	-----	-----	-----	-----

After 0.1 second, one character of the message line ticks. The message appears as follows on the LOGO! onboard display or LOGO! TD:

X2	X3	X4	X5	X6	X7	X8	X9	X10	X11	X12	X13	X14	X15	X16	X17	X18	X19	X20	X21	X22	X23	X24	X1
----	----	----	----	----	----	----	----	-----	-----	-----	-----	-----	-----	-----	-----	-----	-----	-----	-----	-----	-----	-----	----

**Example: Tick Message Line by Line**

The following example uses the same message configuration as the previous example:

X1	X2	X3	X4	X5	X6	X7	X8	X9	X10	X11	X12	X13	X14	X15	X16	X17	X18	X19	X20	X21	X22	X23	X24

If you set this message to tick "line by line" with a tick interval of 0.1 seconds, then the initial appearance of this message on the LOGO! onboard display or LOGO! TD is the left half of the message as shown in this illustration:

X1	X2	X3	X4	X5	X6	X7	X8	X9	X10	X11	X12	X13	X14	X15	X16	X17	X18	X19	X20	X21	X22	X23	X24
----	----	----	----	----	----	----	----	----	-----	-----	-----	-----	-----	-----	-----	-----	-----	-----	-----	-----	-----	-----	-----

After 1 second (10 x 0.1 second), the message ticks to show the right half of the message as shown in this illustration:

X13	X14	X15	X16	X17	X18	X19	X20	X21	X22	X23	X24	X1	X2	X3	X4	X5	X6	X7	X8	X9	X10	X11	X12
-----	-----	-----	-----	-----	-----	-----	-----	-----	-----	-----	-----	----	----	----	----	----	----	----	----	----	-----	-----	-----

The screen display alternates between the two message halves every second.

You can configure each individual line of a message text to tick or not tick. The "character by character" or "line by line" setting applies to all lines that you configure to tick.

### Input P configuration

From the input P, you configure the following characteristics of the message text:

- Priority
- Acknowledgement
- Message destination
- Tick type, and tick setting for each line

To configure the priority and the acknowledgment (programming mode):

B33 1+/ Priority 000 Ack=Off	← "+" means: The parameters and actual values in an active message text can be edited  ← Priority  ← Status of the acknowledgement
---------------------------------------	--

1. Increase the priority to 1: Cursor on '0' + ▲
2. Change to 'Ack': Press ►
3. Enable 'Ack': Press ▲ or ▼

LOGO! shows:

B33 1+/ Priority 001 Ack=On	← Priority 1  ← Status of the acknowledgement "On"
--------------------------------------	--

To configure the message destination and tick type (programming mode):

1. From the Priority and Acknowledgement screen form, press ► to access the Message Destination screen form.

B33 2+/ MsgDest BM	← Message Destination: LOGO! Basic module, LOGO! TD, or both
--------------------------	--

2. Press ► to position the cursor on the "BM" line.
3. Press ▲ or ▼ to toggle through the three choices for message destination: BM, TD, or BM & TD.
4. From the Message Destination screen form, press ► to access the Tick Type screen form.

B33 3+/ TickType Ch by Ch	← Tick Type: Character by Character (Ch by Ch) or Line by Line (Ln by Ln)
---------------------------------	---

5. If your message text has lines that tick, press ► to position the cursor on the "Ch by Ch" line and then press ▲ or ▼ to select either "Ch by Ch" or "Ln by Ln" for the TickType.
6. From the Tick Type screen, press ► to enable or disable ticking for each line of the message text. LOGO! displays the following screen form:

B33 4+/ 1 = No 2 = No	← Tick settings: No: Line does not tick Yes: Line does tick
-----------------------------	---

7. Press ▲ or ▼ to choose between "No" and "Yes" to define whether line 1 ticks.
8. Press ► to move the cursor to the second line, and press ▲ or ▼ to choose between "No" and "Yes" for line 2. From the last line press ► to go to the screen from for lines 3 and 4. Configure line ticking for lines 3 and 4 in the same way as for lines 1 and 2.

B33 5+/ 3 = No 4 = No	← Tick settings: No: Line does not tick Yes: Line does tick
-----------------------------	---

9. Press **OK** to confirm the complete message text configuration.

### Visible parameters or process variables

The following parameters or process variables can be displayed in a message text, as either numerical values or bar-graph representations of values:

Special function	Parameter or process variable visible in a message text
Timers	
On-delay	T, T <sub>a</sub>
Off-delay	T, T <sub>a</sub>
On-/Off-delay	T <sub>a</sub> , TH, TL
Retentive on-delay	T, T <sub>a</sub>
Wiping relay (pulse output)	T, T <sub>a</sub>
Edge triggered wiping relay	T <sub>a</sub> , TH, TL
Asynchronous pulse generator	T <sub>a</sub> , TH, TL
Random generator	T <sub>H</sub> , TL
Stairway lighting switch	T <sub>a</sub> , T, T!, T!L
Multiple function switch	T <sub>a</sub> , T, TL, T!, T!L
Weekly timer	3*on/off/day
Yearly timer	On, Off
Astronomical clock	Longitude, latitude, zone, TS, TR

Special function	Parameter or process variable visible in a message text
Stopwatch	TB, Ta, Lap, AQ
Counter	
Up/down counter	Cnt, On, Off
Hours counter	MI, Q, OT
Threshold trigger	fa, On, Off, G_T
Analog	
Analog threshold trigger	On, Off, A, B, Ax
Analog differential trigger	On, n, A, B, Ax, Off
Analog comparator	On, Off, A, B, Ax, Ay, nA
Analog watchdog	n, A, B, Ax, Aen
Analog amplifier	A, B, Ax
Analog multiplexer	V1, V2, V3, V4, AQ
Analog ramp	L1, L2, MaxL, StSp, Rate, A, B, AQ
PI controller	SP, Mq, KC, TI, Min, Max, A, B, PV, AQ
Mathematic instruction	V1, V2, V3, V4, AQ
PWM (Pulse Width Modulator)	A, B, T, Ax amplified
Miscellaneous	
Latching relay	-
Pulse relay	-
Message texts	-
Softkey	On/Off
Shift register	-
Analog filter	Sn, Ax, AQ
Max/Min	Mode, Min, Max, Ax, AQ
Average value	Ax, St, Sn, AQ

For timers, a message text can also display the remaining time. "Remaining time" refers to how much time of the parameter setting remains.

Bar graphs can be either horizontal or vertical representations of the current or actual value scaled between the minimum and maximum value. For more information on configuring and displaying bar graphs in message texts, refer to the LOGO!Soft Comfort online help.

### Editing message texts

Only simple message texts can be edited from the LOGO! Basic. Text messages created in LOGO!Soft Comfort that make use of new features such as bar graphs, I/O status names, and others can not be edited from the LOGO! Basic.

Also, you cannot edit message texts from the LOGO! Basic that contain any of the following parameters:

- Par
- Time
- Date
- EnTime
- EnDate

You can only edit such message texts from LOGO!Soft Comfort.

### Changing parameters in the active message text

When the message text is active, press **ESC** to select the editing mode.

---

#### Note

You must keep the **ESC** key pressed for at least one second.

---

Press ◀ and ▶ to select the relevant parameter. Press **OK** to change the parameter. Use the ▲ and ▼ keys to edit a parameter.

Confirm your changes with **OK**. You can now edit further parameters in the message text (if any exist). Press **ESC** to exit editing mode.

### Key input simulation in the active message text

You can enable the four cursor keys C ▲, C ▼, C ◀ and C ▶ in an active message text by pressing **ESC** plus the relevant cursor key.

### Setting the Par parameter

View in programming mode:



Parameter assignment  
screen form for Par

Press ► to select a line for the message text.

Press ▲ and ▼ to select the letter to be displayed in the text. To move the cursor from one position to the other, press ◀ and ▶.

The list of available characters is the same as for the circuit program name. The character set is found in topic Circuit program input (Page 86). When you enter message text from the LOGO! Basic, you can only enter characters from the ISO8859-1 character set. To enter text from another language, you must enter the text in LOGO!Soft Comfort.

Note that the number of characters per line of message text can be greater than the number of character positions on the LOGO! onboard display.

Press **OK** to confirm your changes, and press **ESC** to exit the editing mode.

## 4.4.26 Softkey

### Short description

This special function has the effect of a mechanical pushbutton or switch.

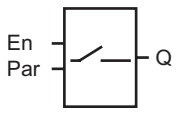
Symbol in LOGO!	Wiring	Description
	Input En	Output Q is set with a 0 to 1 transition of the signal at input En (Enable), and if 'Switch=On' was confirmed in parameter assignment mode.
	Parameter	Programming mode: Selecting the function for pushbutton action for the duration of one cycle, or for switching action. Start: On or off state, initialized at the first start of the program if retentivity is disabled. Retentivity: / = No retentivity R = The status is retentive. Parameter assignment mode (RUN mode): Switch: Switches the momentary pushbutton (switch) on or off.
	Output Q	Switches on if En=1 and Switch=On was confirmed with <b>OK</b> .

### Factory setting

The default parameter setting is switching action.

### Timing diagram

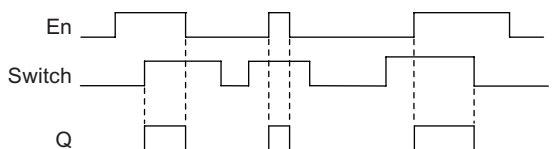

### Functional description

In parameter assignment mode, the output is set with a signal at input En, if the 'Switch' parameter is set to 'On' and confirmed with **OK**. Whether the function was configured for pushbutton or switching action is of no concern here.

The output is reset to '0' in the following three cases:

- After a 1 to 0 transition at input En
- When the function was configured for momentary pushbutton action, and one cycle has expired since it was switched on
- When the position 'Off' was selected at the 'Switch' parameter and confirmed with **OK** in parameter assignment mode

If retentivity is not set, output Q is initialized after a power failure according to your configuration at the "Start" parameter.





Let us assume you want to set 'Switch' (On).

1. Change to the editing mode: Confirm with **OK** (the cursor is now positioned on 'Off')
2. To change from 'Off' to 'On': Press **▲** or **▼**
3. Confirm your entries with Press **OK**

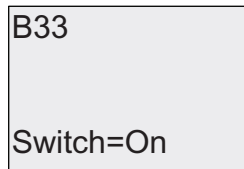

The pushbutton/switch here is switched on

## 4.4.27 Shift register

### Short description

You can use the shift register function to read the value of an input and to shift its bits left or right. The output value corresponds with the configured shift register bit. The shifting direction can be changed at a special input.

Symbol in LOGO!	Wiring	Description
	Input In	Input read at the start of the function.
	Input Trg	A positive edge (0 to 1 transition) at input Trg (Trigger) starts the special function. 1 to 0 transitions are irrelevant.
	Input Dir	The signal at input Dir determines the shifting direction for the shift register bits S1 to S8 (if 0BA6) or Sx.1 to Sx.8 (if 0BA7). "x" refers to the configured shift register byte index 1, 2, 3, or 4.  Dir = 0: Shift up (0BA6: S1 >> S8; 0BA7: Sx.1>>Sx.8)  Dir = 1: Shift down (0BA6: S8 >> S1; 0BA7: Sx.8>>Sx.1)
	Parameter	Shift register bit that determines the value at output Q.  Possible settings (if 0BA6): S1 to S8  Possible settings (if 0BA7): Byte index: 1 to 4  Q: S1 to S8  LOGO! 0BA7 provides a maximum of 32 shift register bits, with 8 bits per shift register.  Retentivity: / = No retentivity R = The status is retentive.
	Output Q	The output value corresponds with the configured shift register bit.

### Functional description

The function reads the value at input In with a positive edge (0 to 1 transition) at input Trg (Trigger).

If your LOGO! is a LOGO! 0BA6, this value is applied to shift register bit S1 or S8, depending on the shifting direction:

- Shift up: The value at input In is set at S1; the previous value at S1 is shifted to S2; the previous value at S2 is shifted to S3 etc.
- Shift down: The value at input In is set at S8; the previous value at S8 is shifted to S7; the previous value at S7 is shifted to S6 etc.

Output Q returns the value of the configured shift register bit.

If retentivity is disabled, the shift function restarts at S1 or S8 after a power failure. When enabled, retentivity always applies to all shift register bits.

If your LOGO! is a LOGO! 0BA7, this value is applied to shift register bit Sx.1 or Sx.8 depending on the shifting direction, where "x" refers to the index number of the shift register and the number after the decimal point refers to the bit number:

- Shift up: The value at input In is set at Sx.1; the previous value at Sx.1 is shifted to Sx.2; the previous value at Sx.2 is shifted to Sx.3 etc.
- Shift down: The value at input In is set at Sx.8; the previous value at Sx.8 is shifted to Sx.7; the previous value at Sx.7 is shifted to Sx.6 etc.

Output Q returns the value of the configured shift register bit.

If retentivity is disabled, the shift function restarts at Sx.1 or Sx.8 after a power failure. When enabled, retentivity always applies to all shift register bits.

---

#### Note

There is only one shift register function block available for use in the circuit program in LOGO! 0BA6.

There are a maximum of four shift register function blocks available for use in the circuit program in LOGO! 0BA7.

---



**Setting the Par parameter (0BA7)**

View in programming mode (example):

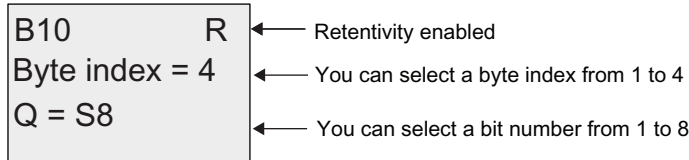

The view above indicates that the configured shift register bit is S4.8.

This special function is not available in parameter assignment mode.

**4.4.28 Analog multiplexer**

**Short description**

This special function outputs one of four predefined analog values or 0 at the analog output.

Symbol in LOGO!	Wiring	Description
	Input En	A change in status from 0 to 1 at input En (Enable) switches a parameterized analog value to the output AQ, depending on the value of S1 and S2.
	Inputs S1 and S2	S1 and S2 (selectors) for selecting the analog value to be issued. <ul style="list-style-type: none"> <li>S1 = 0 and S2 = 0: Value 1 is issued</li> <li>S1 = 0 and S2 = 1: Value 2 is issued</li> <li>S1 = 1 and S2 = 0: Value 3 is issued</li> <li>S1 = 1 and S2 = 1: Value 4 is issued</li> </ul>
	Parameter	V1...V4: Analog values that will be issued. Range of values: -32768...+32767 p: Number of decimals Range of values: 0, 1, 2, 3
	Output AQ	This special function has an analog output. This output can only be connected with the analog input of a function, an analog flag or an analog output connector (AQ1, AQ2). Range of values for AQ: -32768...+32767

## Parameters V1...V4

The analog values for the parameters V1...V4 can be derived from another already-programmed function. You can use the actual values of the following functions:

- Analog comparator (Page 218) (actual value Ax – Ay)
- Analog threshold trigger (Page 213) (actual value Ax)
- Analog amplifier (Page 226) (actual value Ax)
- Analog ramp (Page 251) (actual value AQ)
- Mathematic instruction (Page 265) (actual value AQ)
- PI controller (Page 256) (actual value AQ)
- Up/down counter (Page 201) (actual value Cnt)
- Analog multiplexer (actual value AQ)

If your LOGO! is a LOGO! 0BA7, you can **additionally** use the actual values of the following functions:

- Analog filter (0BA7 only) (Page 271) (actual value AQ)
- Average value (0BA7 only) (Page 276) (actual value AQ)
- Max/Min (0BA7 only) (Page 273) (actual value AQ)
- On-delay (Page 160) (current time Ta)
- Off-delay (Page 164) (current time Ta)
- On-/Off-delay (Page 166) (current time Ta)
- Retentive on-delay (Page 168) (current time Ta)
- Wiping relay (pulse output) (Page 170) (current time Ta)
- Edge triggered wiping relay (Page 172) (current time Ta)
- Asynchronous pulse generator (Page 175) (current time Ta)
- Stairway lighting switch (Page 179) (current time Ta)
- Multiple function switch (Page 182) (current time Ta)
- Stopwatch (0BA7 only) (Page 198) (actual value AQ)
- Threshold trigger (Page 210) (actual value Fre)

Select the required function by the block number. For information on parameter defaults, refer to the On-delay (Page 160) topic.

## Parameter p (number of decimals)

Applies only to the values displayed in a message text.

**Timing diagram**

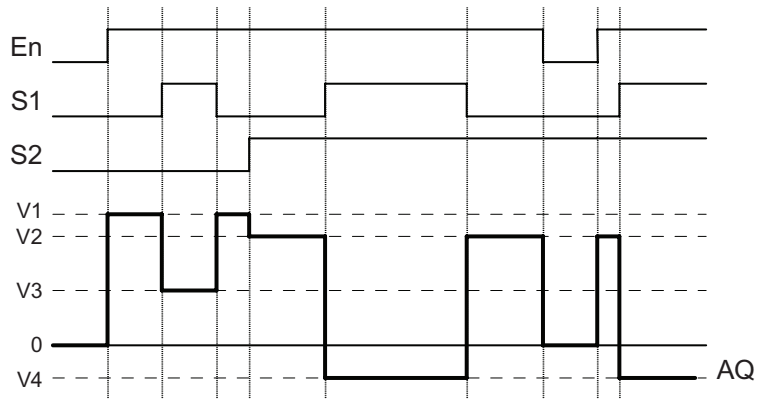

**Functional description**

If input En is set, then the function issues one of four possible analog values V1 to V4 at the output AQ, depending on the value of S1 and S2.

If the input En is not set, then the function issues the analog value 0 at output AQ.

**Analog output**

If you interconnect this special function with a real analog output, note that the analog output can only process values between 0 and 1000. To do this, you may need to connect an additional amplifier between the analog output of the special function and the real analog output. Using this amplifier, you standardize the output range of the special function to a value range of 0 to 1000.

**Setting the Par parameter**

View in programming mode (example):



View in parameter assignment mode:



## 4.4.29 Analog Ramp

### Short description

The Analog Ramp instruction allows the output to be changed from the current level to the selected level at a specified rate.

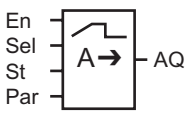
Symbol in LOGO!	Wiring	Description
	Input En	<p>A change in the status from 0 to 1 at input En (Enable) applies the start/stop level (Offset "B" + StSp) to the output for 100 ms and starts the ramp operation to the selected level.</p> <p>A change in the status from 1 to 0 immediately sets the current level to Offset "B", which makes output AQ equal to 0.</p>
	Input Sel	<p>Sel = 0: Level 1 is selected Sel = 1: Level 2 is selected</p> <p>A change in status of Sel causes the current level to start changing to the selected level at the specified rate.</p>
	Input St	<p>A change in the status from 0 to 1 at input St (Decelerated Stop) causes the current level to decrease at a constant rate until the start/stop level (Offset "B" + StSp) is reached. The start/stop level is maintained for 100ms and then the current level is set to Offset "B", which makes output AQ equal to 0.</p>

Symbol in LOGO!	Wiring	Description
	Parameter	<p>Level 1 and Level 2: Levels to be reached Range of values for each level: -10,000 to +20,000</p> <p>MaxL: Maximum value that must not be exceeded under any circumstances. Range of values: -10,000 to +20,000</p> <p>StSp: Start/Stop offset: value that is added to Offset "B" to create the start/stop level. If the Start/Stop offset is 0, then the start/stop level is Offset "B".. Range of values: 0 to +20,000</p> <p>Rate: Acceleration with which level 1, level 2 or Offset is reached. Steps/seconds are issued. Range of values: 1 to 10,000</p> <p>A: Gain Range of values: 0 to 10.00</p> <p>B: Offset Range of values: ±10,000</p> <p>p: Number of decimals Range of values: 0, 1, 2, 3</p>
	Output AQ	<p>The output AQ is scaled using the formula: Range of values for AQ: 0 to +32767</p> <p><math>(\text{Current Level} - \text{Offset "B"}) / \text{Gain "A"}</math> Range of values: 0 to +32767</p> <p>Note: When AQ is displayed in parameter mode or message mode, it is displayed as an unscaled value (engineering units: current level).</p>



## Parameters L1, L2

The analog values for the parameters L1 and L2 can be derived from another already-programmed function. You can use the actual values of the following functions:

- Analog comparator (Page 218) (actual value Ax – Ay)
- Analog threshold trigger (Page 213) (actual value Ax)
- Analog amplifier (Page 226) (actual value Ax)
- Analog multiplexer (Page 248) (actual value AQ)
- Mathematic instruction (Page 265) (actual value AQ)
- PI controller (Page 256) (actual value AQ)
- Up/down counter (Page 201) (actual value Cnt)

If your LOGO! is a LOGO! 0BA7, you can **additionally** use the actual values of the following functions:

- Analog filter (0BA7 only) (Page 271) (actual value AQ)
- Average value (0BA7 only) (Page 276) (actual value AQ)
- Max/Min (0BA7 only) (Page 273) (actual value AQ)
- On-delay (Page 160) (current time Ta)
- Off-delay (Page 164) (current time Ta)
- On-/Off-delay (Page 166) (current time Ta)
- Retentive on-delay (Page 168) (current time Ta)
- Wiping relay (pulse output) (Page 170) (current time Ta)
- Edge triggered wiping relay (Page 172) (current time Ta)
- Asynchronous pulse generator (Page 175) (current time Ta)
- Stairway lighting switch (Page 179) (current time Ta)
- Multiple function switch (Page 182) (current time Ta)
- Stopwatch (0BA7 only) (Page 198) (actual value AQ)
- Analog ramp (actual value AQ)
- Threshold trigger (Page 210) (actual value Fre)

Select the required function by the block number. For information on parameter defaults, refer to the On-delay (Page 160) topic.

## Parameter p (number of decimals)

Applies only to the AQ, L1, L2, MaxL, StSp and Rate values displayed in a message text.

**Timing diagram for AQ**

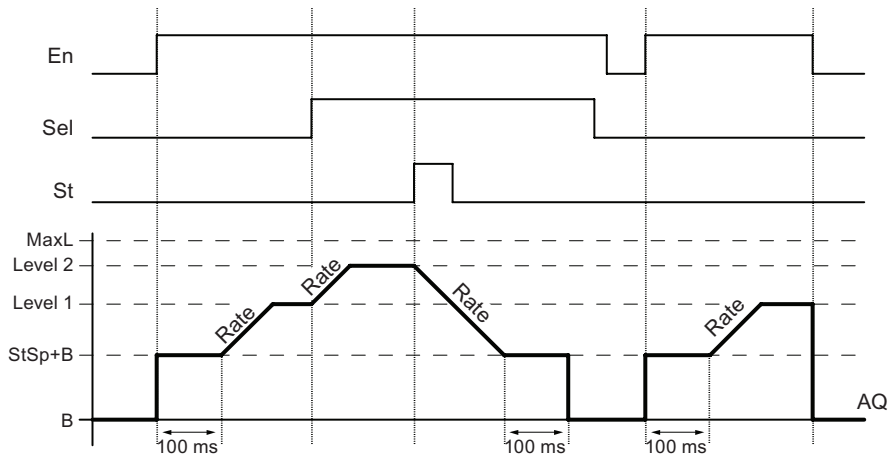

**Functional description**

If the input En is set, then the function sets the current level to StSp + Offset "B" for 100 ms.

Then, depending on the connection of Sel, the function runs from the level StSp + Offset "B" to either level 1 or level 2 at the acceleration set in Rate.

If the input St is set, the function runs to a level of StSp + Offset "B" at the acceleration set in Rate. Then the function holds the level at StSp + Offset "B" for 100 ms. After 100 ms, the level is set to Offset "B". The scaled value (output AQ) is 0.

If the input St is set, the function can only be restarted after the inputs St and En have been reset.

If input Sel has been changed, depending on the connection of Sel, the function runs from the current target level to the new target level at the rate that is specified.

If the input En is reset, the function immediately sets the current level to Offset "B".

The current level is updated every 100 ms. Note the relationship between output AQ and the current level:

$$\text{Output AQ} = (\text{current level} - \text{Offset "B"}) / \text{Gain "A"}$$

**Note**

For further information on analog value processing, please refer to the online help for LOGO!Soft Comfort.

### Setting the Par parameter

View in programming mode (example):

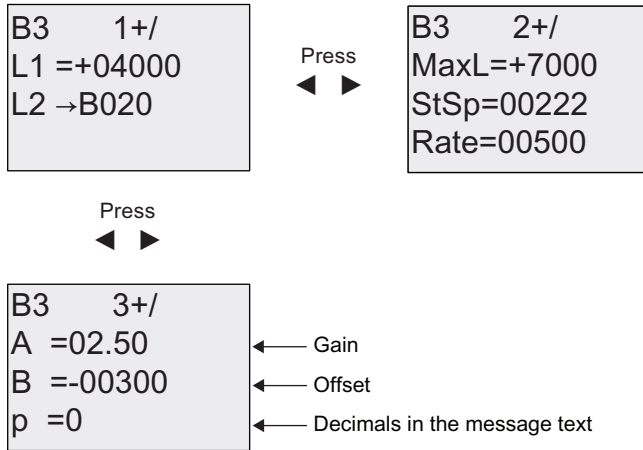

View in parameter assignment mode:

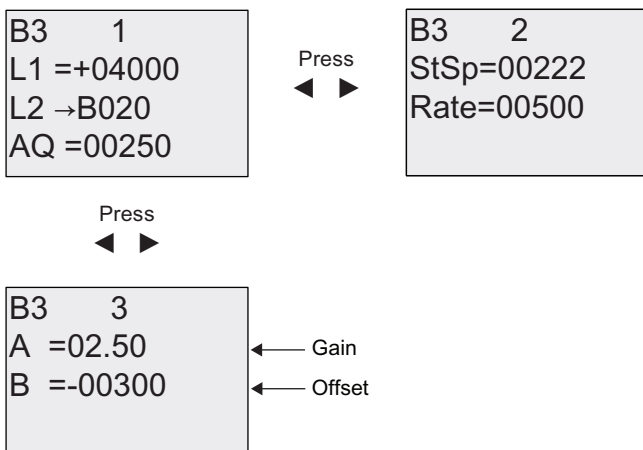

4.4.30 PI controller

Short description

Proportional-action and integral-action controllers. You can use both types of controller individually or combined.

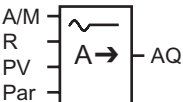
Symbol in LOGO!	Wiring	Description
	Input A/M	Set the mode of the controller: 1: automatic mode 0: manual mode
	Input R	Use the input R to reset the output AQ. As long as this input is set, the input A/M is disabled. Output AQ is set to 0.
	Input PV	Analog value: process variable, influences the output
	Parameter	SP: Set-value assignment Range of values: -10,000 to +20,000 KC: Gain Range of values: 00.00 to 99.99 TI: Integral time Range of values: 00:01 to 99:59 m Dir: Action direction of the controller Range of values: + or - Mq: Value from AQ with manual mode Range of values: 0 to 1000 Min: Minimum value for PV Range of values: -10,000 to +20,000 Max: Maximum value for PV Range of values: -10,000 to +20,000 A: Gain Range of values: ±10.00 B: Offset Range of values: ±10,000 p: Number of decimals Range of values: 0, 1, 2, 3

Symbol in LOGO!	Wiring	Description
	Output AQ	This special function has an analog output (= manipulated variable). This output can only be connected with the analog input of a function, an analog flag or an analog output connector (AQ1, AQ2). Range of values for AQ: 0...1000

## Parameters SP and Mq

The set-value SP and the value for Mq can be provided by another already-programmed function. You can use the actual values of the following functions:

- Analog comparator (Page 218) (actual value Ax – Ay)
- Analog threshold trigger (Page 213) (actual value Ax)
- Analog amplifier (Page 226) (actual value Ax)
- Analog multiplexer (Page 248) (actual value AQ)
- Analog Ramp (Page 251) (actual value AQ)
- Mathematic instruction (Page 265) (actual value AQ)
- Up/down counter (Page 201) (actual value Cnt)

If your LOGO! is a LOGO! 0BA7, you can **additionally** use the actual values of the following functions:

- Analog filter (0BA7 only) (Page 271) (actual value AQ)
- Average value (0BA7 only) (Page 276) (actual value AQ)
- Max/Min (0BA7 only) (Page 273) (actual value AQ)
- On-delay (Page 160) (current time Ta)
- Off-delay (Page 164) (current time Ta)
- On-/Off-delay (Page 166) (current time Ta)
- Retentive on-delay (Page 168) (current time Ta)
- Wiping relay (pulse output) (Page 170) (current time Ta)
- Edge triggered wiping relay (Page 172) (current time Ta)
- Asynchronous pulse generator (Page 175) (current time Ta)
- Stairway lighting switch (Page 179) (current time Ta)
- Multiple function switch (Page 182) (current time Ta)
- Stopwatch (0BA7 only) (Page 198) (actual value AQ)
- PI controller (actual value AQ)
- Threshold trigger (Page 210) (actual value Fre)

Select the required function by the block number. For information on parameter defaults, refer to the On-delay (Page 160) topic.

**Parameters KC, TI**

Please note:

- If parameter KC has value 0, the "P" function (proportional control) will not be executed.
- If parameter TI has value 99:59 m, the "I" function (integral-action control) will not be executed.

**Parameter p (number of decimals)**

Applies only to the PV, SP, Min and Max values displayed in a message text.

**Timing diagram**

The nature, manner and speed with which the AQ changes depend on the parameters KC and TI. Thus, the course of AQ in the diagram is merely an example. A control action is continuous; therefore the diagram portrays just an extract.

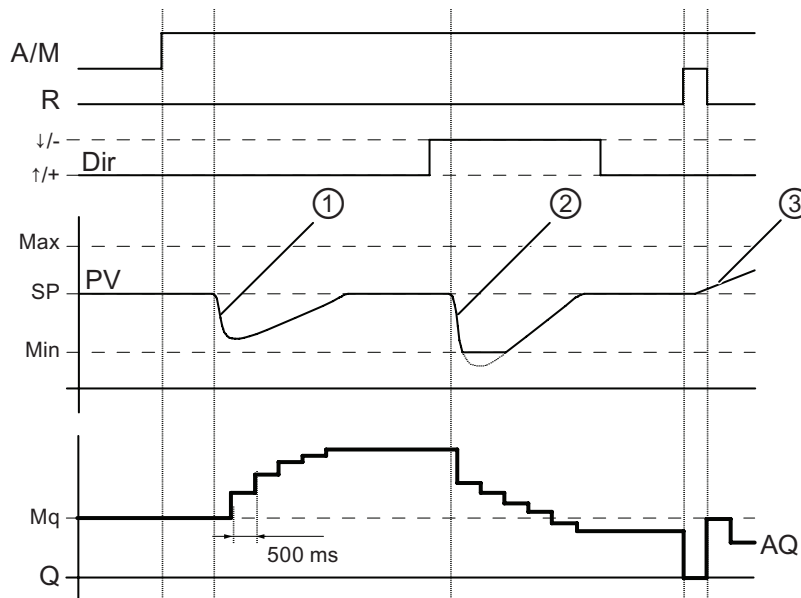

1. A disturbance causes the PV to drop, as Dir is positioned upwards, AQ increases until PV corresponds again to SP.
2. A disturbance causes the PV to drop, as Dir is positioned downwards, AQ decreases until PV corresponds again to SP.  
It is not possible to change the direction (Dir) at runtime of the function. The change is shown here for illustrative purposes only.
3. As AQ is set to 0 by means of the input R, PV changes. This is based on the fact that PV increases, which on account of Dir = upwards causes AQ to drop.

## Functional description

If the input A/M is set to 0, then the special function issues output AQ with the value that you set with parameter Mq.

If the input A/M is set to 1, then automatic mode commences. As an integral sum the value Mq is adopted, the controller function begins the calculations.

---

### Note

For further information on the controller basics, please refer to the online help for LOGO!Soft Comfort.

---

The updated value PV is used to calculate in the formulas:

*Updated value PV* = (PV • gain) + offset

- If the updated value PV = SP, then the special function does not change the value of AQ.
- Dir = upwards (+) (timing diagram numbers 1. and 3.)
  - If the updated value PV > SP, then the special function reduces the value of AQ.
  - If the updated value PV < SP, then the special function increases the value of AQ.
- Dir = downwards (-) (timing diagram number 2.)
  - If the updated value PV > SP, then the special function increases the value of AQ.
  - If the updated value PV < SP, then the special function reduces the value of AQ.

With a disturbance, AQ continues to increase / decrease until the updated value PV again corresponds to SP. The speed with which AQ changes depends on the parameters KC and TI.

If the input PV exceeds the parameter Max, then the updated value PV is set to the value of Max. If the PV falls short of the parameter Min, then the updated value PV is set to the value of Min.

If the input R is set to 1, then the AQ output is reset. As long as R is set, the input A/M is disabled.

## Sampling time

The sampling time is fixed at 500 ms.

## Parameter sets

For more information and application examples with application-related parameter sets for KC, TI and Dir refer to the online help for LOGO!Soft Comfort.

### Setting the Par parameter

View in programming mode (example):

B3 1+/ SP →B020	Press ◀ ▶	B3 2+/ KC =10.00 TI =01:00 Dir=+
--------------------	--------------	---

Press  
◀ ▶

B3 3+/ Mq →B021 Min=-05000 Max=+05000	Press ◀ ▶	B3 4+/ A =02.50 B =-00300 p =0
--	--------------	---

View in parameter assignment mode:

B3 1 SP →B020 PV = 0 AQ =+0250	Press ◀ ▶	B3 2 KC =10.00 TI =01:00 Dir=+
---	--------------	---

Press  
◀ ▶

B3 3 Mq →B021 Min=-05000 Max=+05000	Press ◀ ▶	B3 4 A =02.50 B =-00300
--	--------------	-------------------------------



### 4.4.31 Pulse Width Modulator (PWM)

#### Short description

The Pulse Width Modulator (PWM) instruction modulates the analog input value Ax to a pulsed digital output signal. The pulse width is proportional to the analog value Ax.

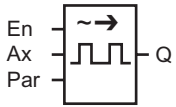
Symbol in LOGO!	Wiring	Description
	Input En	A positive edge (0 to 1 transition) at input En enables the PWM function block.
	Input Ax	Analog signal to be modulated to a pulsed digital output signal.
	Parameter	A: Gain Range of values: $\pm 10.00$ B: Zero offset Range of values: $\pm 10,000$ T: Periodic time over which the digital output is modulated p: Number of decimals Range of values: 0, 1, 2, 3 Min: Range of values: $\pm 20,000$ Max: Range of values: $\pm 20,000$
	Output Q	Q is set or reset for the proportion of each time period according to the proportion of the standardized value Ax to the analog value range.

#### Parameter T

Note the defaults of the T parameters listed in topic Time response (Page 151).

The periodic time T can be provided by the actual value of another already-programmed function. You can use the actual value of the following functions:

- Analog comparator (Page 218) (actual value Ax – Ay)
- Analog threshold trigger (Page 213) (actual value Ax)
- Analog amplifier (Page 226) (actual value Ax)
- Analog multiplexer (Page 248) (actual value AQ)
- Analog Ramp (Page 251) (actual value AQ)
- Mathematic instruction (Page 265) (actual value AQ)
- PI controller (Page 256) (actual value AQ)
- Up/down counter (Page 201) (actual value Cnt)

If your LOGO! is a LOGO! 0BA7, you can **additionally** use the actual values of the following functions:

- Analog filter (0BA7 only) (Page 271) (actual value AQ)
- Average value (0BA7 only) (Page 276) (actual value AQ)
- Max/Min (0BA7 only) (Page 273) (actual value AQ)
- On-delay (Page 160) (current time Ta)
- Off-delay (Page 164) (current time Ta)
- On-/Off-delay (Page 166) (current time Ta)
- Retentive on-delay (Page 168) (current time Ta)
- Wiping relay (pulse output) (Page 170) (current time Ta)
- Edge triggered wiping relay (Page 172) (current time Ta)
- Asynchronous pulse generator (Page 175) (current time Ta)
- Stairway lighting switch (Page 179) (current time Ta)
- Multiple function switch (Page 182) (current time Ta)
- Stopwatch (0BA7 only) (Page 198) (actual value AQ)
- Threshold trigger (Page 210) (actual value Fre)

Select the required function by the block number. The timebase is configurable. For information on valid ranges and parameter defaults, refer to the On-delay (Page 160) topic.

### Parameters p (number of decimals)

Parameter p applies only to the display of the Ax value in a message text

### Functional description

The function reads the value of the signal at the analog input Ax. This value is multiplied by the value of parameter A (gain). Parameter B (offset) is added to the product, as follows:

$$(Ax \cdot \text{Gain}) + \text{Offset} = \text{Actual value Ax}$$

The function block calculates the proportion of the actual value Ax to the range. The block sets the digital output Q high for the same proportion of the T (periodic time) parameter, and sets Q low for the remainder of the time period.

### Examples with Timing Diagrams

The following examples show how the PWM instruction modulates a digital output signal from the analog input value:

#### Example 1

Analog input value: 500 (range 0 ...1000)

Periodic time T: 4 seconds

The digital output of the PWM function is 2 seconds high, 2 seconds low, 2 seconds high, 2 seconds low and continues in that pattern as long as parameter "En" = high.

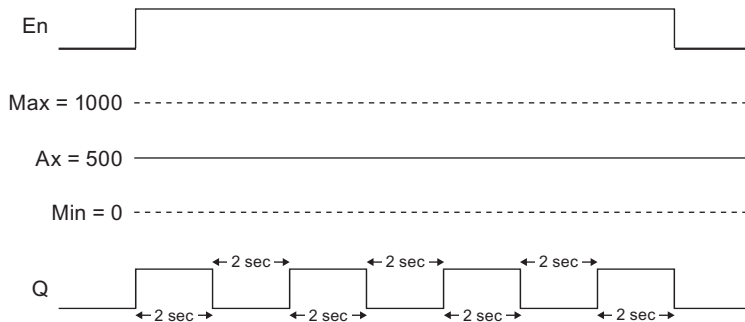

#### Example 2

Analog input value: 300 (range 0 ...1000)

Periodic time T: 10 seconds

The digital output of the PWM function is 3 seconds high, 7 seconds low, 3 seconds high, 7 seconds low and continues in that pattern as long as parameter "En" = high.

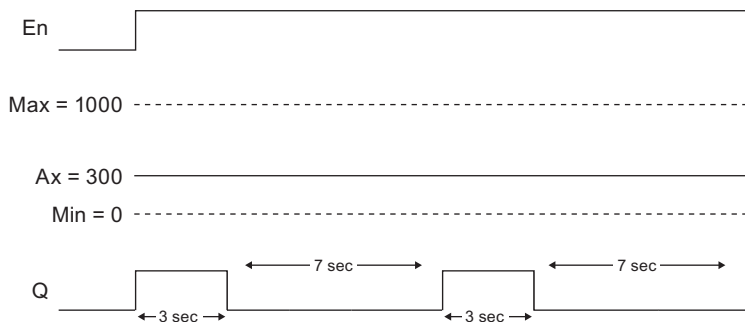

### Calculation rule

$Q = 1$ , for  $(Ax - Min) / (Max - Min)$  of time period T, when  $Min < Ax < Max$

$Q = 0$ , for  $PT - [(Ax - Min) / (Max - Min)]$  of periodic time T.

Note: Ax in this calculation refers to the actual value Ax as calculated using the Gain and Offset.

### Setting the Par Parameter

The following illustration shows the view in programming mode that corresponds to the first example:



Use the ◀ and ▶ keys to navigate to the Min, Max, A, B, T and P parameters. For each digit of a value, use the ▲ and ▼ keys to scroll through value choices. Use the ▶ key to navigate to the second screen from the last line of the first screen, and the ◀ key to navigate from the top line of the second screen to the first screen. Use the OK key to accept changes.

View in parameter assignment mode:



## 4.4.32 Mathematic instruction

### Short description

The mathematic instruction block calculates the value AQ of an equation formed from the user-defined operands and operators.

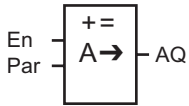
Symbol in LOGO!	Wiring	Description
	Input En	A change in the status from 0 to 1 at input En (Enable) enables the mathematic instruction function block.
	Parameter	<b>V1:</b> First operand value <b>V2:</b> Second operand value <b>V3:</b> Third operand value <b>V4:</b> Fourth operand value  <b>Op1:</b> First operator <b>Op2:</b> Second operator <b>Op3:</b> Third operator  <b>Pr1:</b> Priority of first operation <b>Pr2:</b> Priority of second operation <b>Pr3:</b> Priority of third operation  <b>Qen→0:</b> 0: Reset value of AQ to 0 when En=0 1: Retain last value of AQ when En=0 <b>p:</b> Number of decimals Range of values: 0, 1, 2, 3
	Output AQ	The output AQ is the result of the equation formed from the operand values and operators. AQ will be set to 32767 if a divide by 0 or overflow occurs, and -32768 if a negative overflow (underflow) occurs.

### Parameters V1...V4

The analog values for the parameters V1...V4 can be derived from another already-programmed function. You can use the actual values of the following functions:

- Analog comparator (Page 218) (actual value Ax – Ay)
- Analog threshold trigger (Page 213) (actual value Ax)
- Analog amplifier (Page 226) (actual value Ax)
- Analog multiplexer (Page 248) (actual value AQ)
- Analog Ramp (Page 251) (actual value AQ)
- PI controller (Page 256) (actual value AQ)
- Up/down counter (Page 201) (actual value Cnt)

If your LOGO! is a LOGO! 0BA7, you can **additionally** use the actual values of the following functions:

- Analog filter (0BA7 only) (Page 271) (actual value AQ)
- Average value (0BA7 only) (Page 276) (actual value AQ)
- Max/Min (0BA7 only) (Page 273) (actual value AQ)
- On-delay (Page 160) (current time Ta)
- Off-delay (Page 164) (current time Ta)
- On-/Off-delay (Page 166) (current time Ta)
- Retentive on-delay (Page 168) (current time Ta)
- Wiping relay (pulse output) (Page 170) (current time Ta)
- Edge triggered wiping relay (Page 172) (current time Ta)
- Asynchronous pulse generator (Page 175) (current time Ta)
- Stairway lighting switch (Page 179) (current time Ta)
- Multiple function switch (Page 182) (current time Ta)
- Stopwatch (0BA7 only) (Page 198) (actual value AQ)
- Mathematic instruction (actual value AQ)
- Threshold trigger (Page 210) (actual value Fre)

Select the required function by the block number. For information on parameter defaults, refer to the On-delay (Page 160) topic.

---

**Note**

If the analog value for parameter V1, V2, V3 or V4 is derived from another already-programmed function whose actual value exceeds the value range for V1 ... V4, LOGO! will display the limit value: -32768 if the value is less than the lower range or 32767 if the value is greater than the upper range).

---

**Parameters p (number of decimals)**

Parameter p applies only to the display of Value1, Value2, Value3, Value4 and AQ in a message text.

## Functional Description

The mathematic instruction function combines the four operands and three operators to form an equation. The operator can be any one of the four standard operators: +, -, \*, or /. For each operator, you must set a unique priority of High (H), Medium (M), or Low (L). The high operation will be performed first, followed by the medium operation, and then by the low operation. You must have exactly one operation of each priority. The operand values can reference another previously-defined function to provide the value. The mathematic instruction function rounds the result to the nearest integer value.

The number of operand values is fixed at four and the number of operators is fixed at 3. If you need to use fewer operands, use constructions such as + 0 or \* 1 to fill the remaining parameters.

You can also configure the behavior of the function when the Enable parameter  $En=0$ . The function block can either retain its last value, or be set to 0. If the parameter  $Qen \rightarrow 0 = 0$ , then the function sets AQ to 0 when  $En=0$ . If the parameter  $Qen \rightarrow 0 = 1$ , then the function leaves AQ at its last value when  $En=0$ .

## Possible errors: Zero division and overflow

If the mathematic instruction function block execution results in zero division or overflow, it sets internal bits that indicate the type of error that occurred. You can program a mathematic instruction error detection function block in your circuit program to detect these errors, and to control the program behavior as needed. You program one mathematic instruction error detection function block to reference one specific mathematic instruction function block.

## Examples

The following tables show some simple example mathematic instruction block parameters, and the resulting equations and output values:

V1	Op1 (Pr1)	V2	Op2 (Pr2)	V3	Op3 (Pr3)	V4
12	+ (M)	6	/ (H)	3	- (L)	1

**Equation:**  $(12 + (6 / 3)) - 1$

**Result:** 13

V1	Op1 (Pr1)	V2	Op2 (Pr2)	V3	Op3 (Pr3)	V4
2	+ (L)	3	* (M)	1	+ (H)	4

**Equation:**  $2 + (3 * (1 + 4))$

**Result:** 17

V1	Op1 (Pr1)	V2	Op2 (Pr2)	V3	Op3 (Pr3)	V4
100	- (H)	25	/ (L)	2	+ (M)	1

**Equation:**  $(100 - 25) / (2 + 1)$

**Result:** 25

### Setting the Par parameter

The following illustration shows the view in programming mode that corresponds to the first example  $(12 + (6 / 3)) - 1$ :

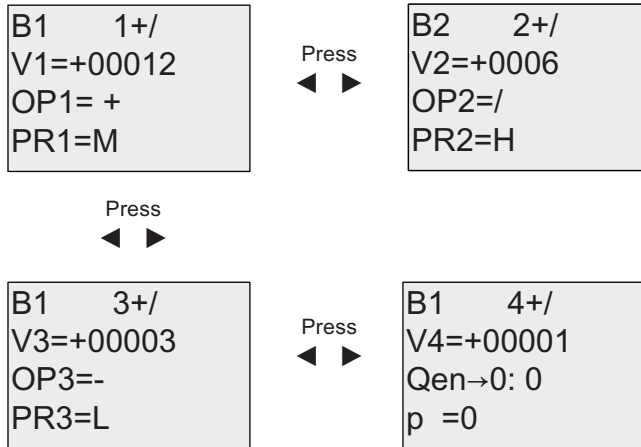

Use the ◀ and ▶ keys to navigate between the operand value, operator, and operation priority. To change a value, use the ▲ and ▼ keys to scroll through value choices for each value. Use the ◀ key to navigate from one screen to the previous screen when the cursor is on the V1..V4 line, and the ▶ key to navigate to the next screen from the PR1..PR3 line. Use the OK key to accept changes.

### 4.4.33 Mathematic instruction error detection

#### Short description

The mathematic instruction error detection block sets an output if an error has occurred in the referenced Mathematic instruction (Page 265) function block.

Symbol in LOGO!	Wiring	Description
	Input En	A change in the status from 0 to 1 at input En (Enable) enables the mathematic instruction error detection block.
	Input R	A signal at input R resets the output.
	Parameter	MathBN: block number of a mathematic instruction Err: ZD: Divide by 0 error OF: Overflow error ZD/OF: (Divide by 0 error) OR (Overflow error) AutoRst: Reset the output before the next execution of the mathematic instruction error function block. Y = yes; N = no
	Output Q	Q is set high if the error to detect occurred in the last execution referenced mathematic instruction function block



## Parameter MathBN

The value for the MathBN parameter references the block number of an already-programmed mathematic instruction function block.

## Functional description

The mathematic instruction error detection block sets the output when the referenced mathematic instruction function block has an error. You can program the function to set the output on a zero division error, an overflow error, or when either type of error occurs.

If AutoRst is set, the output is reset prior to the next execution of the function block. If AutoRst is not set, then whenever the output is set it remains set until the mathematic instruction error detection block is reset with the R parameter. This way, even if the error subsequently clears, the circuit program still has knowledge that an error did occur at some point.

In any scan cycle, if the referenced mathematic instruction function block executes before the mathematic instruction error detection function block, the error is detected in the same scan cycle. If the referenced mathematic instruction function block executes after the mathematic instruction error detection function block, the error is detected in the next scan cycle.

## Mathematic instruction error detection logic table

In the table below, Err represents the parameter of the mathematic instruction error detection instruction that selects which type of error to detect. ZD represents the zero division bit set by the mathematic instruction at the end of its execution: 1 if the error occurred, 0 if not. OF represents the overflow bit set by the mathematic instruction: 1 if the error occurred, 0 if not. The ZD/OF Err parameter represents the logical OR of the zero division bit and overflow bit of the referenced mathematic instruction. Q represents the output of the mathematic instruction error detection function. An "x" indicates that the bit can be either 0 or 1 with no influence on the output.

Err	ZD	OF	Q
ZD	1	x	1
ZD	0	x	0
OF	x	1	1
OF	x	0	0
ZD/OF	1	0	1
ZD/OF	0	1	1
ZD/OF	1	1	1
ZD/OF	0	0	0

If the MathBN parameter is null, then the output Q is always 0.

### Setting the Par parameter

The parameters MathBN, AutoRst, and Err can be set in programming mode or parameter assignment mode.

View in programming mode (example):

B3    +/ MathBN=B001 AutoRst=N Err=ZD/OF	← Block number of an already-programmed analog math instruction
	← Auto Reset (Y or N)
	← ZD, OF, or ZD/OF

Use the ◀ and ▶ keys to navigate between the MathBN, AutoRst, and Err parameters. To change a value, use the ▲ and ▼ keys to scroll through value choices for each value. Use the OK key to accept changes.

View in parameter assignment mode (example):

B3 MathBN=B001 AutoRst=N Err=ZD/OF	← Block number of an analog math instruction
	← Auto Reset (Y or N)
	← ZD, OF, or ZD/OF

### 4.4.34 Analog filter (OBA7 only)

#### Short Description

The analog filter function smooths the analog input signal.

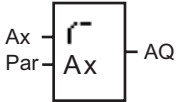
Symbol in LOGO!	Wiring	Description
	Ax	Input Ax is the analog input signal to be smoothed. Input Ax is one of the following analog signals: <ul style="list-style-type: none"> <li>• AI1 to AI8 (*)</li> <li>• AM1 to AM16</li> <li>• NAI1 to NAI32</li> <li>• AQ1 to AQ2</li> <li>• NAQ1 to NAQ16</li> <li>• Block number of a function with analog output</li> </ul>
	Parameter	<b>Sn</b> (Number of samples) determines how many analog values are sampled within the program cycles that are determined by the set number of samples. LOGO! samples an analog value within every program cycle. The number of program cycles is equal to the set number of samples.  Possible settings: 8, 16, 32, 64, 128, 256
	Output AQ	AQ is the average value of input Ax over the current number of samples.
* AI1...AI8: 0...10 V corresponds with 0...1000 (internal value).		

#### Timing diagram (example)

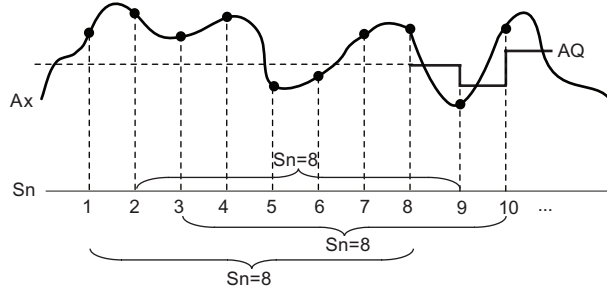

### Functional description

The function fetches the analog signal at input Ax based on the set number of samples (Sn) and outputs the average value.

---

#### Note

There are a maximum of eight analog filter function blocks available for use in the circuit program in LOGO! 0BA7.

---

### Setting the Par parameter

View in programming mode (example):

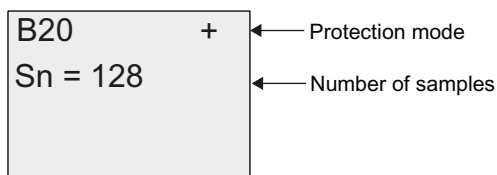

### 4.4.35 Max/Min (0BA7 only)

#### Short description

The Max/Min function records the maximum or minimum value of Ax.

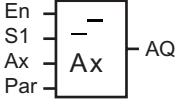
Symbol in LOGO!	Wiring	Description
	En	A signal at input En (Enable) outputs an analog value to AQ, depending on the settings of parameters ERst and Mode.
	S1	S1 functions only when the parameter Mode is set to 2. If Mode is set to 2, a change in status from 0 to 1 at input S1 (selector) outputs the maximum value to AQ. If Mode is set to 2, a change in status from 1 to 0 at S1 outputs the minimum value to AQ.
	Ax	Input Ax is one of the following analog signals: <ul style="list-style-type: none"> <li>• AI1 to AI8 (*)</li> <li>• AM1 to AM16</li> <li>• NAI1 to NAI32</li> <li>• AQ1 to AQ2</li> <li>• NAQ1 to NAQ16</li> <li>• Block number of a function with analog output</li> </ul>
	Parameter	<b>Mode:</b> Possible settings: 0, 1, 2, 3 Mode = 0: AQ = Min Mode = 1: AQ = Max Mode = 2 and S1= 0 (low): AQ = Min Mode = 2 and S1= 1 (high): AQ = Max Mode = 3: AQ = Actual value of Ax <b>ERst</b> (Enable Reset): Possible settings: ERst = 0: Disable reset ERst = 1: Enable reset Retentivity: / = No retentivity R = The status is retentive
	Output AQ	The function issues a minimum, maximum, or current value at AQ, depending on your configuration.
* AI1...AI8: 0...10 V corresponds with 0...1000 (internal value).		

## Parameter Mode

The value for parameter Mode can be provided by the actual value of another already-programmed function. You can use the actual values of the following functions:

- Analog comparator (Page 218) (actual value Ax – Ay)
- Analog threshold trigger (Page 213) (actual value Ax)
- Analog amplifier (Page 226) (actual value Ax)
- Analog multiplexer (Page 248) (actual value AQ)
- Analog Ramp (Page 251) (actual value AQ)
- Mathematic instruction (Page 265) (actual value AQ)
- PI controller (Page 256) (actual value AQ)
- Up/down counter (Page 201) (actual value Cnt)
- Analog filter (0BA7 only) (Page 271) (actual value AQ)
- Average value (0BA7 only) (Page 276) (actual value AQ)
- On-delay (Page 160) (current time Ta)
- Off-delay (Page 164) (current time Ta)
- On-/Off-delay (Page 166) (current time Ta)
- Retentive on-delay (Page 168) (current time Ta)
- Wiping relay (pulse output) (Page 170) (current time Ta)
- Edge triggered wiping relay (Page 172) (current time Ta)
- Asynchronous pulse generator (Page 175) (current time Ta)
- Stairway lighting switch (Page 179) (current time Ta)
- Multiple function switch (Page 182) (current time Ta)
- Stopwatch (0BA7 only) (Page 198) (actual value AQ)
- Max/Min (0BA7 only) (actual value AQ)
- Threshold trigger (Page 210) (actual value Fre)

Select the required function by the block number.

### Timing diagram (example)

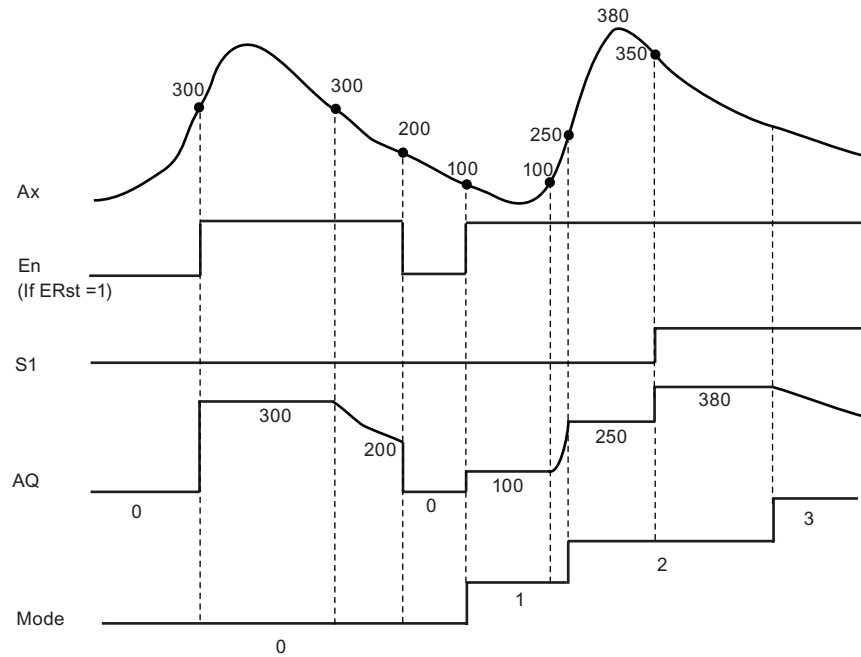

### Functional description

ERst = 1 and En = 0: The function sets the AQ value to 0.

ERst = 1 and En = 1: The function outputs a value at AQ, depending on the settings of Mode and S1.

ERst = 0 and En = 0: The function holds the value of AQ at the current value.

ERst = 0 and En = 1: The function outputs a value at AQ, depending on the settings of Mode and S1.

Mode = 0: The function sets AQ to the minimum value

Mode = 1: The function sets AQ to the maximum value

Mode = 2 and S1 = 0: The function sets AQ to the minimum value

Mode = 2 and S1 = 1: The function sets AQ to the maximum value

Mode = 3: The function outputs current analog input value.

### Setting the Par parameter

View in programming mode (example)

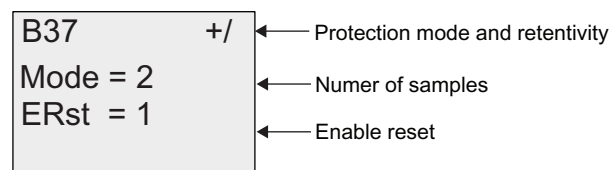

### 4.4.36 Average value (0BA7 only)

#### Short description

The average value function calculates the average value of an analog input over a configured time period.

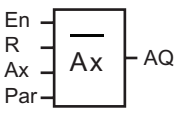
Symbol in LOGO!	Wiring	Description
	En	<p>A change in status from 0 to 1 transition at input En starts the average value function.</p> <p>A change in status from 1 to 0 at input En holds the analog output value.</p>
	R	A signal at input R clears the analog output value.
	Ax	<p>Input Ax is one of the following analog signals:</p> <ul style="list-style-type: none"> <li>• AI1 to AI8 (*)</li> <li>• AM1 to AM16</li> <li>• NAI1 to NAI32</li> <li>• AQ1 to AQ2</li> <li>• NAQ1 to NAQ16</li> <li>• Block number of a function with analog output</li> </ul>
	Parameter	<p><b>St</b> (Sampling time): You can set the timebase to s (seconds), d (days), h (hours), or m (minutes).                      Range of values:                      St = s: 1 to 59                      St = d: 1 to 365                      St = h: 1 to 23                      St = m: 1 to 59</p> <p><b>Sn</b> (Number of samples):                      Range of values:                      St = s: 1 to St*100                      St = d: 1 to 32767                      St = h: 1 to 32767                      St = m and St ≤ 5 minutes: 1 to St*6000                      St = m and St ≥ 6 minutes: 1 to 32767</p> <p>Retentivity:                      / = No retentivity                      R = Retentivity</p>
Output AQ	Outputs the average value of input Ax over configured time sampling period.	
<p>* AI1...AI8: 0...10 V corresponds with 0...1000 (internal value).</p>		



### Timing diagram (example)

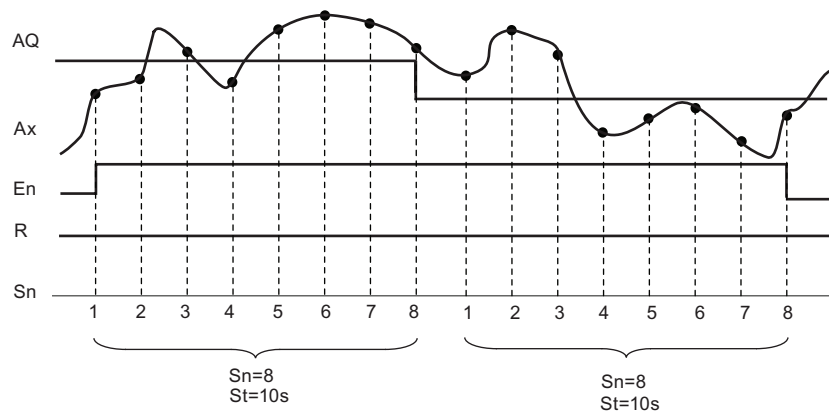

### Functional description

This function fetches the analog input signal according to both the set sampling time St and the number of samples Sn and outputs the average value. A signal at R sets AQ to 0.

### Setting the Par parameter

View in programming mode (example):

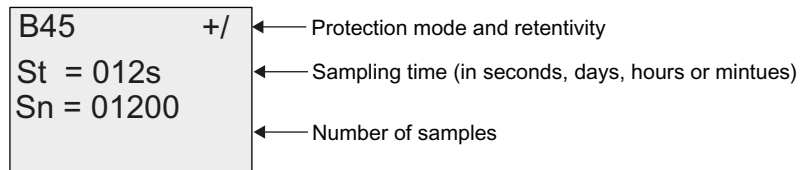



## UDF (User-Defined Function) (0BA7 only)

### User-Defined Function (UDF)

LOGO!Soft Comfort V7.0 provides you with a new option for creating circuit programs - the UDF (User-Defined Function) editor. You can save circuit programs created in the UDF editor as individual UDF blocks for use in a circuit program in the UDF or FBD editor.

A UDF block is a preconfigured circuit program that you create. You can add it to an existing circuit program as you do with a function block. If the circuit program in LOGO!Soft Comfort already contains a UDF, after transferring the program from LOGO!Soft Comfort to a LOGO! 0BA7, you can edit the elements connected to this UDF from the module.

For a detailed description of the UDF configuration in LOGO!Soft Comfort, refer to the online help for LOGO!Soft Comfort V7.0.

### Editing elements connected to a UDF block

You can neither create a UDF block from LOGO! 0BA7, nor edit the members of the block. You can only edit elements connected to the inputs or outputs of a UDF block or edit its parameter settings.

---

#### Note

Each UDF block has a maximum of eight inputs and four outputs, dependent upon your configuration in LOGO!Soft Comfort. On the LOGO! module, only one input and one output are active at a time.

---

**Editing elements to the inputs of a UDF block:**

1. Switch LOGO! to programming mode.

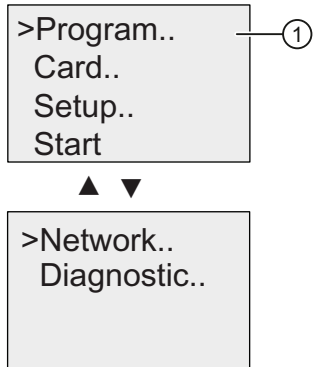

2. Select "①" on the main menu: Press ▲ or ▼
3. Confirm "①": Press **OK**

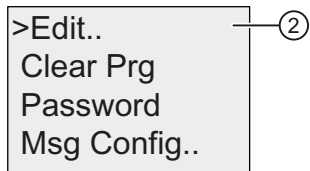

4. Select "②": Press ▲ or ▼
5. Confirm "②": Press **OK**

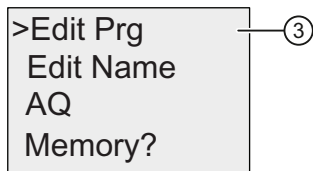

6. Select "③": Press ▲ or ▼
7. Confirm "③": Press **OK**

The following display shows you an example of the circuit program that contains a UDF block configured from LOGO!Soft Comfort. The display alternates between the following two screen forms. UDF blocks are identified with a U. "U01" in "U01.1" refers to the first UDF block that connects to Q1. ".1" refers to the first output of this UDF block that is connected to Q1.

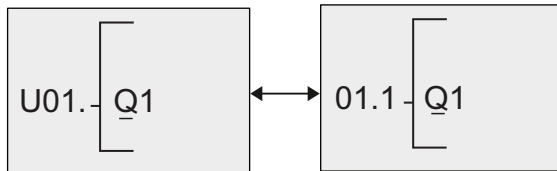

8. Press ◀ until LOGO! steps into the screen form for the first UDF block U01.

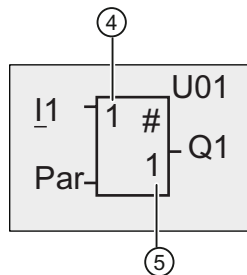

9. Press ▶ to move the cursor to "④", then press **OK**. The cursor appears in a flashing solid square. Note that "1" in position "④" represents the first input of the UDF block U01 that is connected to I1. "1" in position "⑤" represents the first output of U01 that is connected to Q1.
10. Press ▲ or ▼ to view other active inputs created in LOGO!Soft Comfort. The display below shows you that the third input of U01 is connected to F1. If you want to change the element connected to this third input "3", press **OK**.

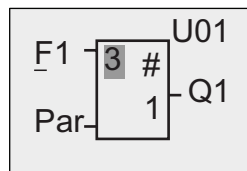

11. Press ◀ to move the cursor to the F in F1, then press **OK**. You can select an element from available lists.
12. To confirm your selection, press **OK**.

**Editing elements to the outputs of a UDF block:**

If LOGO! shows the following screen form as shown in step 10 above and you want to change the element connected to "1" where "1" indicates the first output of the UDF block U01 that is connected to Q1, follow these steps:

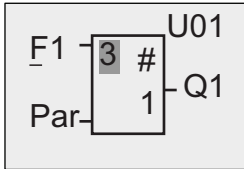

1. Press **ESC** to return to the menu as shown in step 5 above. Repeat steps 6 and 7. LOGO! shows the following display:

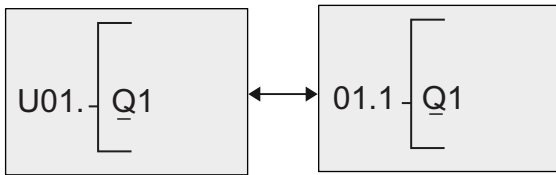

2. When the cursor is below the Q in Q1, press **▲**, **▼** or **▶** to select another element from available lists, for example, M3. Press **◀** to move the cursor to the left.

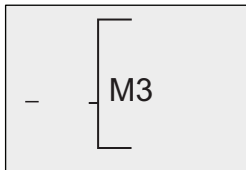

3. When the cursor appears in an underscore, press **OK**.
4. Press **▲** or **▼** to select **UDF** and LOGO! shows the following display:

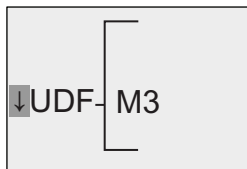

5. Press **OK**. LOGO! provides you with available UDF blocks configured in LOGO!Soft Comfort, in this example, U01.
6. Press **◀** until LOGO! steps into the following screen form for the first UDF block U01:

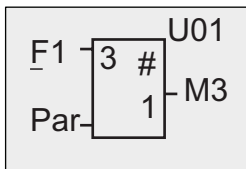

You have changed the element connected to the first output of U01 from Q1 to M3.

## Setting the Par parameter

You can edit the **Par** parameter for your UDF block if you configured parameters for this UDF using LOGO!Soft Comfort; otherwise, you cannot edit parameters for UDF blocks. In this case, the UDF block display shows no "Par":

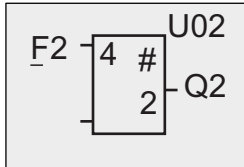

If your UDF block contains the **Par** parameter, you can edit the parameters as described below:

View in programming mode (example):

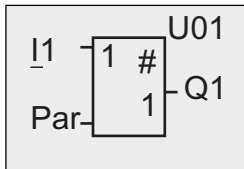

1. Press ▼ to move the cursor to "Par" and press **OK**. LOGO! shows you the following display (A and B are the identifiers you specified for the relevant UDF parameters in LOGO!Soft Comfort . You can configure a maximum of eight parameters for each UDF block using LOGO!Soft Comfort. LOGO! can show a maximum of three parameters on a single display.):

```

U 1      1/1
A  =    1.00
B  =     0
  
```

2. "1/1" in this example means this is the first view of U1 parameters and U1 has a total of one view of parameters. When you press **OK**, LOGO! show the following display:

```

U 1      1/1
A  =  +01.00
B  =     0
  
```

3. Press ▲ or ▼ to change the plus sign into minus. Press ◀ or ▶ to select a number and then press ▲ or ▼ to change the number. Press **OK** to confirm your changes. LOGO! shows the following display:

```

U 1      1/1
A  =  -05.02
B  =     0
  
```

4. Press ▼ to see the final view:

U 1		1/1
A	=	-5.02
B	=	0

You can also edit UDF parameter settings in parameter assignment mode in the same way as you do in programming mode.



## Data Log (0BA7 only)

You can configure a maximum of one Data Log for your circuit program using LOGO!Soft Comfort. The Data Log is used to record process measurement variables of the selected function blocks. You can add the Data Log instruction to your circuit program as you do with a function block.

If you configured the Data Log for your circuit program, after transferring the program from LOGO!Soft Comfort to LOGO!, you can edit the elements connected to the Data Log block.

For a detailed description of configuration of the Data Log function in LOGO!Soft Comfort, refer to the online help for LOGO!Soft Comfort V7.0. From LOGO! 0BA7, you can only configure elements connected to the Data Log block.

### Editing elements connected to the Data Log block

LOGO! shows a Data Log function block with the following display:

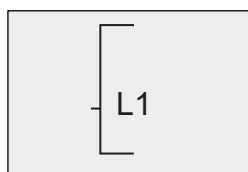

If your circuit program in LOGO! contains a Data Log block configured from LOGO!Soft Comfort, you can edit elements connected to this Data Log as follows:

1. Switch to programming mode. Press **OK** to step into the following display of your circuit program:

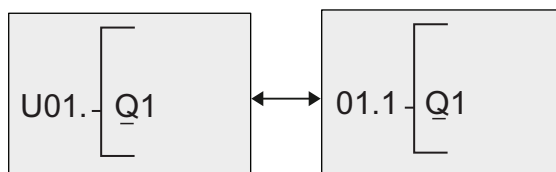

2. Press **▶** to move the cursor until you see "L1" (The Data Log is identified with an L).

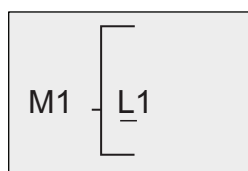

3. You can see that a flag M1 is connected to the Data Log block L1. Press OK or ◀ to move the cursor to "M" in "M1". Press **OK**. LOGO! shows the following display:

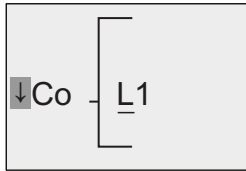

4. You can select a different element from available lists and press **OK** to confirm. In the following example, you can see that this Data Log block L1 is now connected to the B3 block:

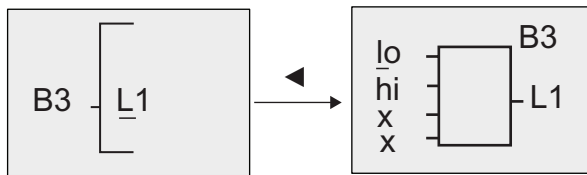

---

**Note**

LOGO! 0BA7 provides a 1024-byte buffer for data logging. If the data in this buffer reaches 512 bytes, LOGO! automatically writes data to the SD card inserted in the SD card slot. If the speed of data generation in LOGO! 0BA7 is faster than that of data write to the SD card, data loss may occur. To avoid the occurrence of data loss, apply an enable signal to the data log function block at a minimum time interval of 500 ms.

A data log file on the SD card can store a maximum of 2,000 records.

Only the most recent data log file on the SD card can be uploaded from LOGO! to LOGO!Soft Comfort.

Under the following three circumstances, LOGO! creates a new data log file:

- When LOGO! has downloaded a circuit program configured with the data log function from LOGO!Soft Comfort
  - When the data log file in LOGO! is not properly closed at the time LOGO! in RUN mode is powered off
  - When your edits to the circuit program in LOGO! influence the data log configuration made in LOGO!Soft Comfort
-

## Configuring LOGO!

Parameter assignment refers to the configuration of the block parameters. You can set delay times for time functions, the switching times of timers, counter threshold values, the monitoring interval of an hours counter, the on and off thresholds of the trigger, and more.

You can configure the parameters

- In programming mode
- In parameter assignment mode

In programming mode, the author of the circuit program also sets the parameters

Parameter assignment mode allows the editing of parameters without having to modify the circuit program. This feature is available so that you can edit parameters without having to change to programming mode. The advantage: The circuit program remains protected, but can be adapted by the user to meet specific requirements.

---

### Note

In parameter assignment mode, LOGO! continues execution of the circuit program.

---

## 7.1 Selecting parameter assignment mode

Press ESC to change from RUN to parameter assignment mode:

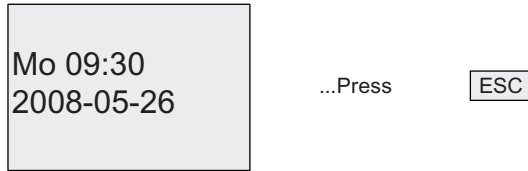

### Note

The following applies to earlier device versions up to 0BA2: you open parameter assignment mode by pressing **ESC+OK**.

LOGO! changes to parameter assignment mode and opens the parameter assignment menu:

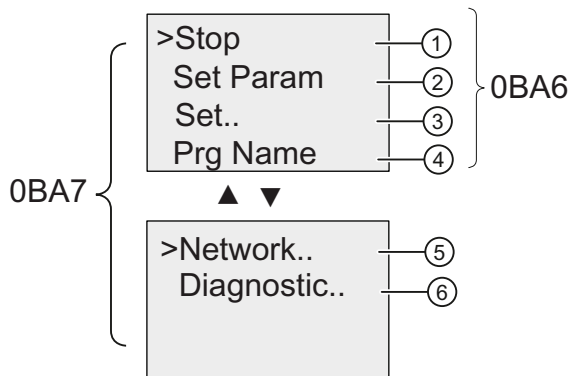

### Description of the four menu items of the parameter assignment menu

- **Menu command ①**

You select this command to stop your circuit program and thus change to the main menu of programming mode. To do so:

1. To move the '>' cursor to "①": Press ▲ or ▼
2. To confirm "①": Press **OK**

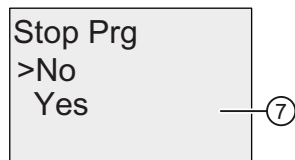

3. To move the '>' cursor to "⑦": Press ▲ or ▼
4. To confirm "⑦": Press **OK**

LOGO! shows the main menu of the programming mode:

LOGO! 0BA6 main menu

```
>Program..
Card..
Setup..
Start
```

LOGO! 0BA7 main menu

```
>Program..
Card..
Setup..
Start
```



```
>Network..
Diagnostic..
```

- **Menu command ②**

For information on the various parameters, refer to the topics "Parameters (Page 290)", "Selecting the parameters (Page 291)", and "Modifying parameters (Page 292)".

- **Menu command ③**

For information on the various settings, refer to the topic "Setting the default values for LOGO! (Page 294)".

- **Menu command ④**

This menu command only allows you to **read** the name of your circuit program. It is not possible to modify this name in parameter assignment mode (Page 90).

- **Menu command ⑤**

For information on the various settings, refer to the topic Configuring network settings (Page 119) and the topic Changing LOGO! to normal/slave mode (Page 123).

- **Menu command ⑥**

For information on the various settings, refer to the topic Diagnosing errors from LOGO! (Page 128)

## 7.1.1 Parameters

---

### Note

The following discourse on parameters assumes that the respective default parameter mode ("+") has been maintained. This is a prerequisite for viewing and editing parameters in the parameter assignment mode! See the "Parameter protection (Page 153)" topic and the "Synchronization (Page 116)" topic.

---

Parameters are, for example:

- The delay times of a timer relay
- The switching times (cams) of a timer switch
- Counter thresholds
- The monitoring time for hour counters
- The trigger thresholds

Each one of the parameters is identified by its block number (Bx) and the shortname of the parameter. Examples:

- T: ...is a configurable time
- MI: ...is a configurable time interval

---

### Note

LOGO!Soft Comfort also allows you to assign names to blocks (for more information, refer to the chapter entitled "LOGO! Software (Page 313)".

---

## 7.1.2 Selecting the parameters

To select a parameter:

1. On the parameter assignment menu, select '**Set Param**': Press ▼ or ▲

```

Stop
>Set Param
Set..
Prg Name
  
```

2. Confirm with **OK**.

LOGO! shows the first parameter. If no parameter can be set, you can press ESC to return to the parameter assignment menu.

```

Block number
B9      1
T =60:00s
Ta =06:00s
  
```

Display number for functions with several displays

The value set at parameter T (Time)

The current time in LOGO!

```

No Param
Press ESC
  
```

No parameters for editing:  
Press ESC to return to the  
parameter assignment menu

3. Now, select the desired parameter: Press ▲ or ▼
4. Select the parameter you want to edit, and press **OK**.

### 7.1.3 Modifying parameters

You first select the parameter you want to edit (Page 291).

You change the value of the parameter in the same way as you did in programming mode:

1. Move the cursor to the point at which you want to make the change:  
Press ◀ or ▶
2. To change this value: Press ▲ or ▼
3. To apply the value: OK

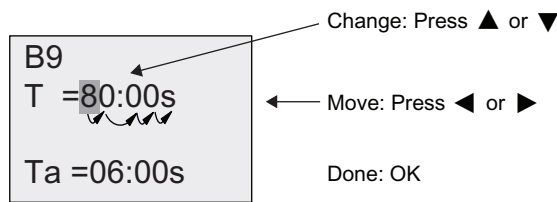

#### Note

When changing the time parameter when the system is in RUN, you can also change the timebase (s=seconds, m=minutes, h=hours). This does not apply if the time parameter represents the result of another function (for an example, see the "On-delay (Page 160)" topic). In this case you can neither change the value nor the timebase. The current time is reset to zero when you change the timebase.

### Current value of a time T

View of a time T in parameter assignment mode:

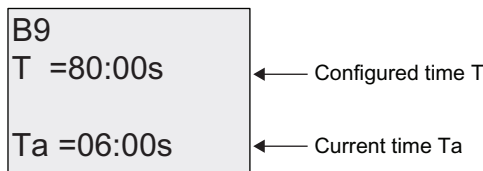

You can change the configured time T.

### Current timer value

View of a timer cam in parameter assignment mode:

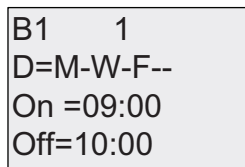

You can change the on/off times and the day.



### Current value of a counter

View of a counter parameter in parameter assignment mode:

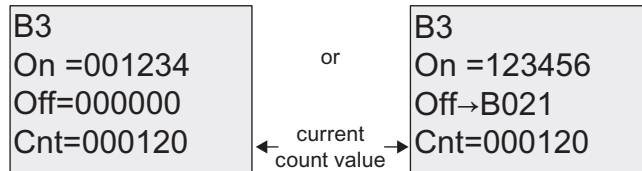

You can change the on/off threshold. This does not apply if the on or off threshold represents the result of another function (in the "Up/down counter (Page 201)" topic, this is B021).

### Current value of an hour counter

View of an hour counter parameter in parameter assignment mode:

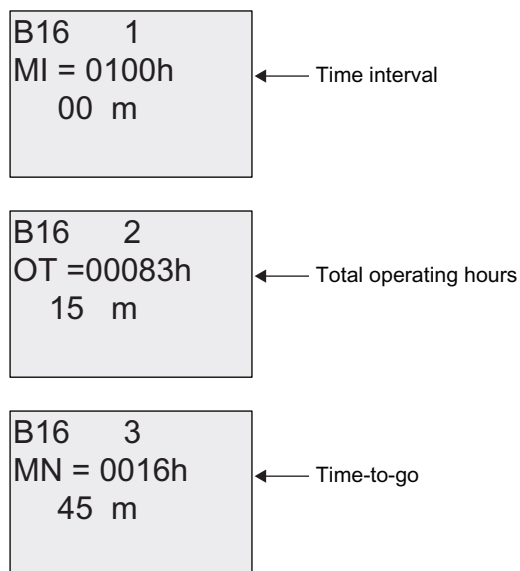

You can edit the configured time interval MI.

### Current value of a threshold trigger

View of the parameter of a threshold trigger in parameter assignment mode:

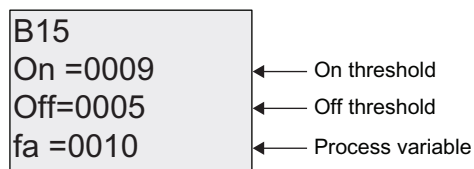

You can change the on/off threshold.

## 7.2 Setting the default values for LOGO!

You can set the following default values for a LOGO! Basic:

### Clock settings

You can set the default values for time-of-day and date (Page 295) , summertime/wintertime conversion (Page 111) and synchronization (Page 116):

- in parameter assignment mode by means of the set menu ("Clock" menu item)
- in programming mode by means of the setup menu ("Clock" menu item)

### Contrast and backlight settings

You can set the default value for the display contrast (Page 296):

- in parameter assignment mode by means of the set menu ("LCD" menu item)
- in programming mode by means of the setup menu ("LCD" menu item)

You can set the default value for the backlight (Page 296):

- in programming mode by means of the setup menu ("LCD" menu item)

### Menu Language

You can set the language (Page 298) in which the LOGO! menus will be displayed:

- in parameter assignment mode by means of the set menu ("Menu Lang" menu item)
- in programming mode by means of the setup menu ("Menu Lang" menu item)

### Number of Base Module Analog Inputs

The LOGO! Base Modules LOGO! 24, LOGO! 24o, LOGO! 24C, LOGO! 24Co, LOGO! 12/24RC, LOGO! 12/24RCo and LOGO! 12/24RCE support four analog inputs. Formerly they supported two. You can choose whether to use two or four analog inputs (Page 299) on these modules:

- in programming mode by means of the setup menu ("BM AI NUM" menu item)

### Start screen settings

You can select the default setting for the start screen (Page 300) that displays on LOGO! and the LOGO! TD when LOGO! transitions to RUN mode:

- in parameter assignment mode by means of the set menu ("StartScreen" menu item)

### Message Text settings

You can select settings that apply to all message text function blocks (Page 231) from the Programming menu.

### 7.2.1 Setting the time of day and date (LOGO! ... C)

You can set the time of day and the date

- in parameter assignment mode by means of the set menu ("Clock" menu item)
- in programming mode by means of the setup menu ("Clock" menu item)

#### To set the time of day and the date in parameter assignment mode:

1. Select parameter assignment mode (Page 288).
2. On the parameter assignment menu, select '**Set..**': Press ▼ or ▲

```

Stop
Set Param
>Set..
Prg Name
  
```

3. Confirm '**Set..**': Press **OK**
4. Move the '>' cursor to '**Clock**': Press ▲ or ▼
5. Confirm '**Clock**': Press **OK**
6. Move the '>' cursor to '**Set Clock**': Press ▲ or ▼
7. Apply '**Set Clock**': Press **OK**

---

#### Note

The 'Set Clock' command is only executed if your LOGO! is equipped with a real-time clock (LOGO!..C). You set the real-time clock of LOGO! by means of the 'Set Clock' command.

---

LOGO! shows the following display.

```

Set Clock
Mo 15:30
YYYY-MM-DD
2008-05-26
  
```

The cursor is positioned on the weekday.

8. Select the day of the week: Press ▲ or ▼
9. Move the cursor to the next position: Press ◀ or ▶
10. To change the value: Press ▲ or ▼
11. To set the correct time of day, repeat steps 9. and 10.
12. To set the correct date, repeat steps 9. and 10.
13. To confirm your entries: Press **OK**

**To set the time of day and the date in programming mode:**

If you want to set the time of day and the date in programming mode, select **'Setup'** in the main menu, then menus **'Clock'** and **'Set Clock'**. You can now set the weekday and the time as described earlier (as of step 8.).

**7.2.2 Setting the display contrast and backlight choice**

You can set the default value for the display contrast

- in parameter assignment mode by means of the set menu ("LCD" menu item)
- in programming mode by means of the setup menu ("LCD" menu item).

**To set the display contrast in parameter assignment mode:**

1. Select parameter assignment mode (Page 288).
2. On the parameter assignment menu, select **'Set'**: Press ▼ or ▲
3. Confirm **'Set..'**: Press **OK**
4. On the Set menu, select **'LCD'**: Press ▼ or ▲
5. Confirm **'LCD..'**: Press **OK**
6. By default, the cursor points to **Contrast**.  
If not, move the '>' cursor to **'Contrast'**: Press ▲ or ▼
7. Confirm **'Contrast'**: Press **OK**

LOGO! shows the following display:

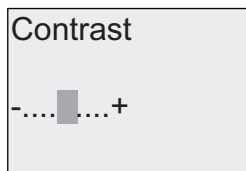

8. To change the display contrast: Press ◀ or ▶
9. To confirm your entry: Press **OK**

**To set the display contrast in programming mode:**

If you want to set the display contrast in programming mode, select **'Setup'** in the main menu, then menu **'Contrast'**. You can now set the display contrast as described earlier (as of step 8.).

**To set the backlight choice in programming mode:**

You can set the default value for the backlight in programming mode only.

1. In the main menu, select "①": Press ▼ or ▲

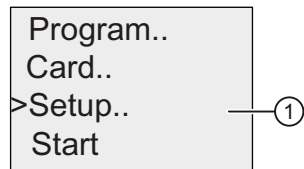

2. Confirm "①": Press **OK**

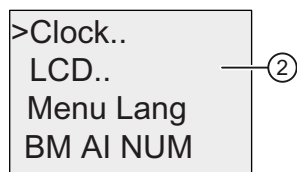

3. Select "②": Press ▼ or ▲
4. Confirm "②": Press **OK**

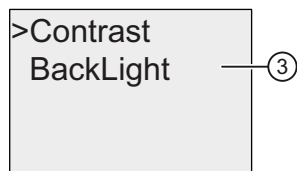

5. Select "③": Press ▼ or ▲
6. Confirm "③": Press **OK**

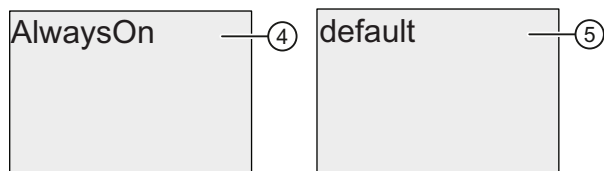

7. Move the cursor to "④" or "⑤": Press ▼ or ▲
8. Confirm "④" or "⑤": Press **OK**

The default is that the backlight is not on. To set the backlight to always be on, select "④".

**Note:** The backlight lifetime of the LOGO! TD is 20,000 hours.

### 7.2.3 Setting the menu language

The language of the LOGO! menus can be one of ten predefined languages:

CN (Chinese)	DE (German)	EN (English)	ES (Spanish)	FR (French)
IT (Italian)	NL (Dutch)	RU (Russian)	TR (Turkish)	JP (Japanese)

#### To set the menu language in parameter assignment mode:

1. Select parameter assignment mode (Page 288).
2. On the parameter assignment menu, select '**Set**': Press ▼ or ▲
3. Confirm 'Set.': Press **OK**
4. On the Set menu, select '**Menu Lang**': Press ▼ or ▲
5. Confirm 'Menu Lang': Press **OK**
6. Move the '>' cursor to the language of your choice: Press ▲ or ▼
7. Confirm language selection. Press **OK**

#### To set the menu language in programming mode:

If you want to set the menu language in programming mode, select '**Setup**' in the main menu, then menu '**Menu Lang**'. You can now set the menu language as described earlier (as of step 6.).

#### To reset LOGO! to its default language setting:

If you want to restore LOGO! to its default language setting (English), do the following:

1. Switch off LOGO! and then switch it on again.
2. When an hourglass icon displays, press ◀ , ▶ and **OK** together until the English menu entries appear.

## 7.2.4 Setting the number of AIs in the LOGO! Basic

LOGO! 12/24RC/RCo/RCE, LOGO! 24/24o and LOGO! 24C/24Co support up to four onboard inputs that can be used as either digital or analog inputs (0 ...10V). Inputs I7 (AI1) and I8 (AI2) are available as analog inputs by default, whether you use them or not. Inputs I1 (AI3) and I2 (AI4) are optional analog inputs. A LOGO! Basic provides a menu where you can choose to use two analog inputs (the default, AI1 and AI2), or four. Regardless of the settings, inputs I1 and I2 can be used as digital inputs. To use them as analog inputs AI3 and AI4, you must set the 'BM AI NUM' to four. Note that the number of configured analog inputs on the LOGO! Basic affects the subsequent numbering of analog inputs on attached expansion modules (See the "Maximum setup (Page 34)" topic).

You can set the number of AIs in programming mode only.

### To set the number of AIs in programming mode:

1. In the main menu, select "①": Press ▼ or ▲

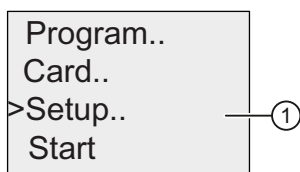

2. Confirm "①": Press **OK**

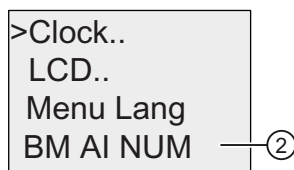

3. Select "②": Press ▼ or ▲
4. Confirm "②": Press **OK**
5. Move to "2AI" or "4AI": Press ▲ or ▼
6. Confirm selection: Press **OK**

---

#### Note

If you change the number of analog inputs, LOGO! restarts automatically.

---

### See also

Selecting parameter assignment mode (Page 288)

### 7.2.5 Setting the start screen

You can select the default setting for the start screen that LOGO! and the LOGO! TD will display in RUN mode. You make this selection from LOGO! in parameter assignment mode.

**To select the start screen:**

1. Select parameter assignment mode (Page 288).

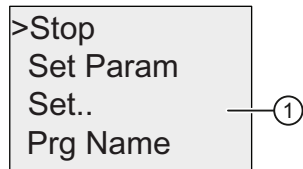

2. On the parameter assignment menu, select "①": Press ▼ or ▲
3. Confirm "①": Press **OK**

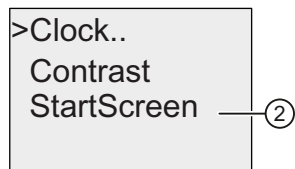

4. Move to "②": Press ▲ or ▼
5. Confirm "②": Press **OK**

View in LOGO! 0BA6:

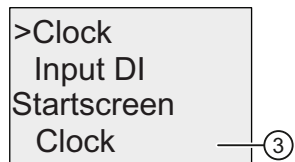

The current setting of the start screen is shown in the bottom row. The default setting is "③".

You can choose to display the current time-of-day and date, or the values of the digital inputs.

View in LOGO! 0BA7:

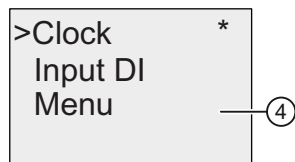

The menu command "④" is available in LOGO! 0BA7 only. With this menu command, the start screen of LOGO! 0BA7 and the ES7 version of the LOGO! TD defaults to their respective parameter assignment menus. You can also choose to display the current time-of-day and date, or the values of the digital inputs:

6. Select the desired default setting: Press ▲ or ▼
7. To confirm your entry: Press **OK**



LOGO! displays your selection.

Power the LOGO! Basic off then on to make your changes take effect. When LOGO! is in RUN mode, both LOGO! and the LOGO! TD will display the start screen that you selected.



## Applicable cards

LOGO! 0BA6 provides the following cards for program storage and real-time clock backup:

- LOGO! Memory Card
- LOGO! Battery Card
- LOGO! Memory/Battery Card

Each of the three cards is color-coded to make them easily distinguishable from one another. They also vary in size. The LOGO! Memory Card (purple) provides storage for the circuit program. The LOGO! Battery Card (green) provides battery backup of the real-time clock for up to two years. The LOGO! Memory/Battery card (brown) provides both circuit program storage and battery backup of the real-time clock.

LOGO! 0BA7 does not support the above-mentioned three cards. LOGO! 0BA7 only supports standard SD cards for program storage.

### WARNING

Risk of death, personal injury or property damage can occur if you use the battery card or combined memory/battery card in a hazardous location.

Do not insert/remove the memory card, battery card, or combined memory/battery card in hazardous locations.

The LOGO! 0BA6 Memory Card and the LOGO! 0BA6 Memory/Battery Card provide 32 Kbytes memory space: four times the memory space of the LOGO! 0BA5 Memory Card.

LOGO! allows you to store only one circuit program in its memory. If you want to modify the circuit program or create an additional one without deleting the first, you must archive it somewhere.

You can copy the LOGO! circuit program to a LOGO! Memory Card, a LOGO! Memory/Battery card, or a standard SD card (0BA7 only). You can then insert this card in another LOGO! of the same device series in order to copy the circuit program. This enables you to manage your programs in the following ways:

- Archive circuit programs
- Reproduce circuit programs
- Send circuit programs by mail
- Write and test your circuit program at the office, and then transfer it to a LOGO! in the switching cabinet

LOGO! is supplied with a hood. The LOGO! Memory Card, LOGO! Battery Card and LOGO! Memory/Battery Card are supplied separately.

---

**Note**

You do **not** need a memory card or combined memory/battery card to backup the circuit program in your LOGO!

The LOGO! circuit program is automatically stored in nonvolatile memory when you exit the programming mode.

---

You can backup the LOGO! circuit program on a memory card, a combined memory/battery card, or a standard SD card. The order numbers are found in the Appendix section entitled "Order numbers (Page 363)".

**Compatibility (Old memory cards in newer LOGO! modules)**

... to earlier versions (0BA4 and 0BA5 devices):

Data written to the memory card in an 0BA5 version can be read in all 0BA6 versions. 0BA4 memory cards cannot be read by 0BA6 versions.

... to earlier versions (0BA0 to 0BA3 devices):

A memory card that contains data written in earlier versions (0BA0...0BA3 devices) cannot be used in LOGO! devices of the 0BA4 and later generations. When the LOGO! system detects such an 'old' memory card, the message "Unknown Card / Press ESC" is output to the display.

Vice versa, a 0BA4 or later memory card cannot be used in LOGO! devices of the 0BA0...0BA3 family.

**Compatibility (New memory, battery, or combined memory/battery cards in older LOGO! modules)**

The LOGO! 0BA6 memory card can be used in 0BA4 or 0BA5 devices to store a circuit program but cannot be used in 0BA0 ... 0BA3 devices.

A LOGO! 0BA6 Memory Card or LOGO! 0BA6 Memory/Battery Card that already has a LOGO! 0BA6 circuit program stored on it cannot be used in any device other than a LOGO! 0BA6 device.

A LOGO! 0BA6 Battery Card or LOGO! 0BA6 Memory/Battery Card can only be used in 0BA6 devices.

A standard SD card can only be used in device series 0BA7.

**Upward compatibility of circuit programs**

Circuit programs written for the previous versions 0BA0...0BA5 can be transferred to 0BA6 or 0BA7 devices from LOGO!Soft Comfort.

## 8.1 Security function (CopyProtect)

The security function provides copy protection for circuit programs on memory cards, combined memory/battery cards or SD cards.

### Unprotected cards

You can edit circuit programs without restrictions and exchange data between the card and the device.

### Protected cards

A circuit program is **protected** when it is transferred from a protected program card to LOGO!.

To execute this circuit program in LOGO!, the protected card must remain inserted during RUN; that is, the circuit program stored on the card cannot be copied to other LOGO! devices.

In addition, a protected circuit program is write-protected.

A circuit program **with password** protection is no longer protected after the correct password has been entered; that is, you can then edit the program and remove the card.

---

#### Note

When you create the circuit program for a card, you need to assign a password (Page 91) to be able to edit it at a later time.

---

### Correlation between the password and the protective function

Password	Protection	Editing	Copying	Deleting
-	-	Yes	Yes	Yes
Yes	-	Yes, with password	Yes	Yes, with password
-	Yes	No	No	Yes
Yes	Yes	Yes, with password	Yes, with password	Yes, with password

### Assigning a security function

To assign a circuit program and copy protection function to the card, open the programming mode and select "Card".

1. Switch LOGO! to programming mode (ESC / >Stop).
2. Select the 'Card' command: Press ▲ or ▼
3. To apply 'Card': Press OK
4. Move the '>' cursor to 'CopyProtect': Press ▲ or ▼
5. To apply 'CopyProtect': Press OK

LOGO! shows the following display:

```
>No
Yes
CopyProtect:
No
```

The current protection setting is shown in the bottom line. This function is disabled by default ("No": disabled).

### Enabling the security function

To set the security function:

1. Move the '>' cursor to 'Yes': Press ▲ or ▼
2. Confirm 'Yes': Press OK

LOGO! shows the following display:

```
>No
Yes
CopyProtect:
Yes
```

---

#### Note

This only generates a circuit program and copy protection for the card; the circuit program itself must be copied (Page 309) separately from LOGO! to the card. (This copy can be done at power-on.)

You can always change the "No" status (security function disabled) to "Yes" (security function enabled).

A status change from "Yes" (security function enabled) to "No" (security function disabled) is only possible if the card does not contain a circuit program.

---

## 8.2 Inserting and removing the card from LOGO!

When you remove a LOGO! memory card, a combined memory/battery card, or an SD card that contains a circuit program with copy protection attributes, note the following: The circuit program stored on the card can only be executed if the card remains inserted during system runtime.

After you have removed the card, LOGO! outputs the message 'No Program'. A removal of the card during RUN will lead to impermissible operating states.

Always heed the following warning:

<p><b>⚠ WARNING</b></p> <p>Do not touch the open slot of the memory card or SD card with your fingers or with a metallic or conductive object. Death or personal injury may result.</p> <p>The memory card/SD card socket might be under voltage if the polarity is accidentally reversed at L1 and N.</p> <p>The memory card, battery card, or combined memory/battery card must only be removed by qualified personnel using the directions below.</p>
--

### Removing the memory card, battery card or combined memory/battery card

To remove the memory card, carefully insert a screwdriver with a 3-mm blade into the groove on the upper end of the card, and lever the module partially out of the slot. You can now remove the memory card.

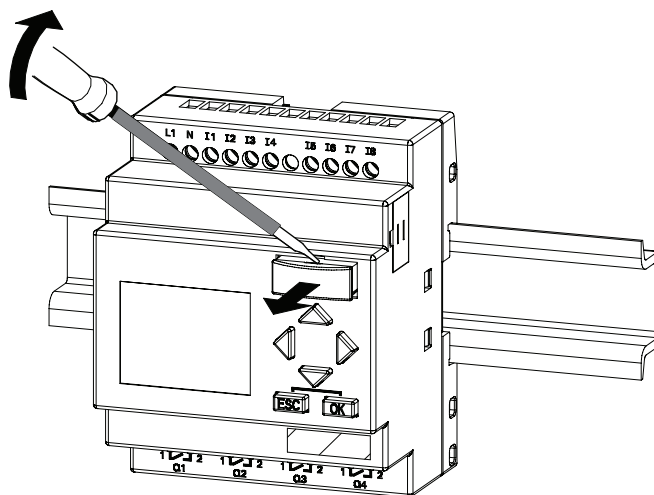

8.2 Inserting and removing the card from LOGO!

To remove a battery card, or combined memory/battery card, slide a screwdriver with a 3-mm blade into the slot on the upper surface of the card until it engages in the back, then with the screwdriver engaged, pull the card out with your hand.

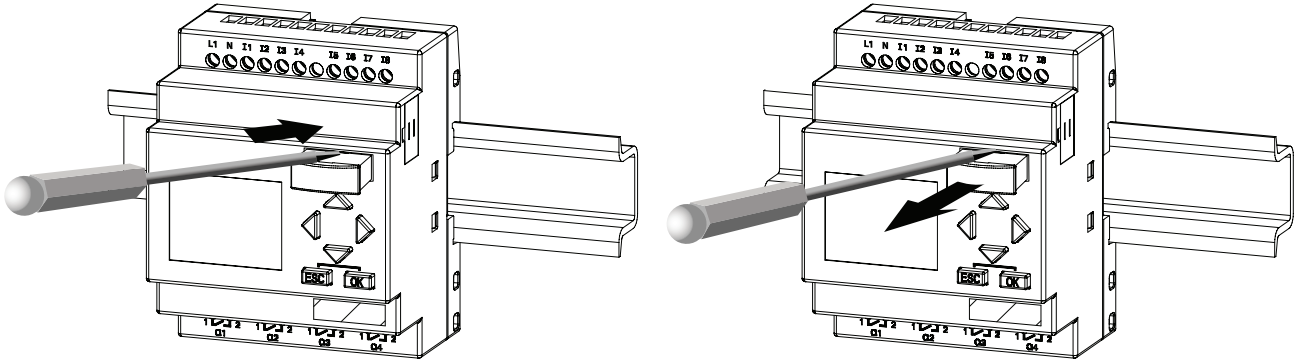

Removing the SD card slot cap from LOGO! 0BA7

To insert the SD card into the slot, you must first remove the slot cap with a screwdriver with a 3-mm blade.

LOGO! 0BA7

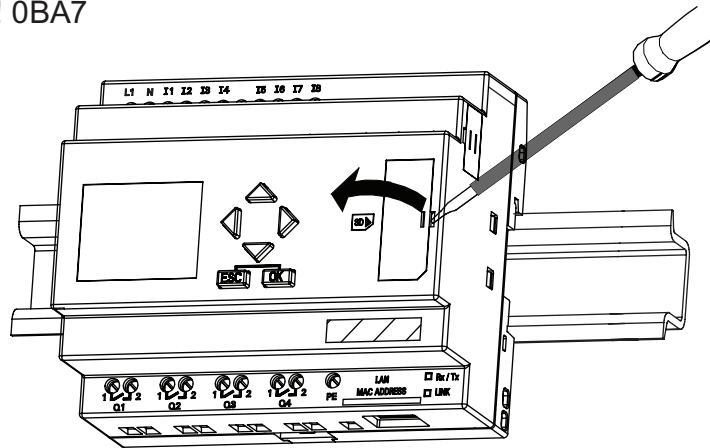

Removing the SD card

To remove the SD card, pull the card out with your hand.

Inserting a memory card, battery card, combined memory/battery card or SD card

The entry of the card slot is chamfered on its bottom right. The edge of the cards is chamfered accordingly. This encoding prevents you from inserting cards the wrong way. Insert the card into the slot and push it in until it engages.



## 8.3 Copying data from LOGO! to the card

### Copying data from LOGO! to the card manually

To manually copy the circuit program to the memory card, combined battery/memory card, or the SD card, follow these steps:

1. Insert the card into the slot.
2. Switch LOGO! to programming mode (ESC / >Stop).

<pre>&gt;Program.. Card.. Setup.. Start</pre>	LOGO! main menu
---	-----------------

3. The main menu opens. To select the 'Card' command: Press ▲ or ▼
4. Press **OK**. The transfer menu opens.

<pre>&gt; [LOGO!] → Card Card → [LOGO!] CopyProtect</pre>	[LOGO!] = LOGO!
---	-----------------

5. Move the '>' cursor to 'LOGO → Card' (if required): Press ▲ or ▼
6. Press **OK**.

LOGO! now copies the circuit program to the card. (If the card is from an incompatible 0BA0..0BA4 version, LOGO! displays this message: "Card unknown/ Press ESC".)

When LOGO! has finished copying, it automatically returns you to the main menu:

<pre>&gt;Program.. Card.. Setup.. Start</pre>
---

The circuit program backup is now stored on your card and you can remove the card. **Do not forget** to replace the cap.

If power fails while LOGO! is copying the circuit program, repeat the process after Power On.

---

#### Note

The password of a protected circuit program in LOGO! also applies to the copied program version on your card.

---

### Copying data from LOGO! 0BA7 to the SD card automatically

LOGO!Soft Comfort V7.0 provides an option for automatically copying the circuit program to the SD card when transferring the circuit program to LOGO! 0BA7. This option is available in the dialog for PC->LOGO! transfer. If you select this option, the circuit program is transferred to LOGO! 0BA7 and then automatically copied from LOGO! 0BA7 to the SD card.

---

#### Note

To successfully copy the circuit program from LOGO! 0BA7 to the SD card, make sure that the free memory space available on the SD card is at least 65 Kbytes.

---

### Generating the data log on the SD card

If your circuit program in LOGO! 0BA7 includes a Data Log function block configured from LOGO!Soft Comfort, the data log can be saved in your LOGO! or on the SD card. If there is an SD card inserted into the slot of your LOGO! 0BA7, when LOGO! changes from STOP to RUN, it attempts to copy the data log to the SD card; otherwise, the data log is saved in LOGO!. At every STOP to RUN transition, LOGO! determines the destination of the data log storage.

If the data log is copied to the SD card, it is saved by default as .CSV file format, which you can then open from a PC. Each line in the .CSV file includes a time stamp, the function block number and the actual values recorded.

---

#### Note

When LOGO! with an inserted SD card is in STOP mode, you can upload the most recent data log file on the SD card to LOGO!Soft Comfort using a transfer menu command in LOGO!Soft Comfort. For more information about the data log uploading command, refer to the online help for LOGO!Soft Comfort.

---

## 8.4 Copying data from the card to LOGO!

You can copy a circuit program from a compatible memory card, combined memory/battery card, or an SD card to LOGO! in one of the following ways:

- Automatically during the startup of LOGO! (POWER ON)
- By means of the "Card" menu of LOGO!
- By means of the "Card" menu of the LOGO! TD (version ES7)

---

### Note

If the program on the module/card is protected with a password, the copied program in LOGO! is also protected with the same password.

---

### Automatic copying during the startup of LOGO!

Proceed as follows:

1. Switch off the power supply to LOGO! (POWER OFF)
2. Remove the slot cover.
3. Insert the card into the relevant slot.
4. Switch on the power supply to LOGO!

LOGO! copies the program from the program module/card to LOGO!. (If the card is from an incompatible 0BA0..0BA3 version, LOGO! displays this message: "Unknown Card / Press ESC".)

When LOGO! has finished copying, it opens the main menu:

```
>Program..
Card..
Setup..
Start
```

---

### Note

Before you switch LOGO! to RUN, you must ensure that the system you are controlling with LOGO! does not represent a source of hazard.

---

5. Move the '>' cursor to '**Start**': Press ▲ or ▼
6. Press **OK**.

### Copying by means of the "Card" menu

For information on the replacement of a memory card, combined memory/battery card, or an SD card, also note the information in the topic "Inserting and removing the card from LOGO! (Page 307)".

To copy a program from the card to LOGO!:

1. Insert the card
2. Switch LOGO! to programming mode (ESC / >Stop).

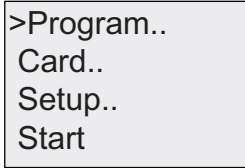

3. Move the '>' cursor to 'Card': Press ▲ or ▼
4. Press **OK**. The transfer menu opens.
5. Move the '>' cursor to 'Card → LOGO!': Press ▲ or ▼

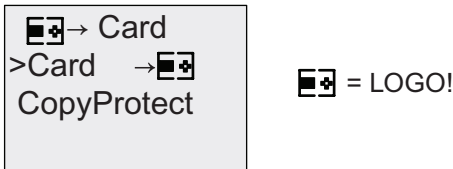

6. Press **OK**.

LOGO! copies the circuit program from the card to LOGO!. (If the card is from an incompatible 0BA0..0BA3 version, LOGO! displays this message: "Unknown Card / Press ESC".)

When LOGO! has finished copying, it automatically returns to the main menu.

## LOGO! software

### 9.1 LOGO! software

LOGO!Soft Comfort is available as a programming package for the PC. This software provides many features, for example:

- A graphic interface for offline creation of your circuit program by means of Ladder Diagram (contact chart / circuit diagram) or Function Block Diagram (function chart)
- Simulation of your circuit program on the PC
- Generating and printing of an overview chart for the circuit program
- Saving a backup of the circuit program on the hard drive or other media
- Comparing circuit programs
- Easy configuration of blocks
- Transferring the circuit program in both directions:
  - from LOGO! to the PC
  - from the PC to LOGO!
- Reading the values of the hour counter
- Setting the time of day
- Summertime/wintertime conversion
- Online test: Display of status changes and process variables of LOGO! in RUN mode:
  - Status of a digital I/O, flags, shift register bits and cursor keys
  - The values of all analog I/O and flags
  - The results of all blocks
  - The current values (including the times) of selected blocks
- Starting and stopping circuit program execution via the PC (RUN, STOP)
- Network communication (0BA7-specific feature)
- Creating UDF blocks for use in a circuit program (0BA7-specific feature)
- Configuring the Data Log function block for your circuit program to record process values of the configured function blocks (0BA7-specific feature)

## The LOGO! alternatives

As you can see, LOGO!Soft Comfort represents an alternative to conventional engineering methods, with several advantages:

- You can develop the circuit program on your PC.
- You simulate the circuit program on your computer and verify its functions before you actually implement it in your system.
- You can add comments to the circuit program and create hard copies.
- You can save a copy of your circuit program to the file system on your PC, to make it directly available for modifications.
- It takes only a few key actions to download the circuit program to LOGO!.

## LOGO!Soft Comfort

LOGO!Soft Comfort runs under Windows 7.0<sup>®</sup>, Windows Vista<sup>®</sup>, Windows 98<sup>®</sup>, Windows NT 4.0<sup>®</sup>, Windows Me<sup>®</sup>, Windows 2000<sup>®</sup>, Windows XP<sup>®</sup>, Linux<sup>®</sup>, and Mac OS X<sup>®</sup>. LOGO!Soft Comfort is capable of client/server operation and offers you a high degree of freedom and comfort for creating your circuit program.

## LOGO!Soft Comfort V7.0

This is the current version of LOGO!Soft Comfort. You will find all the functions and the functionality of the devices described in the online help for LOGO!Soft Comfort V7.0.

## Upgrading previous LOGO!Soft Comfort versions

You can use the **Help** → **Update Center** menu command in LOGO!Soft Comfort V7.0 to upgrade LOGO!Soft Comfort V1.0, V2.0, V3.0, V4.0, V5.0, or V6.1 to V7.0.

Order numbers are found in the Appendix topic "Order numbers".

---

### Note

If a full version is not installed, you can carry out an upgrade as follows:

- Install the new software from the DVD.
  - When the system prompts you for the previous version, place the old LOGO!Soft Comfort DVD in the DVD drive.
  - Point your browser to the "...Application" directory on the DVD.
- 

## Updates and info

You can download demo versions of the software free of charge from the Internet address specified in the preface.

For detailed information on updates, upgrades and the LOGO!Soft Comfort Update Center, refer to the LOGO!Soft Comfort online help.

## 9.2 Connecting LOGO! to a PC

### Connecting the PC cable (for LOGO! 0BA6 only)

To connect LOGO! to a PC, you need the LOGO! PC cable. See the Appendix "Order numbers (Page 363)".

Turn the power off to the LOGO! Base Module. Remove the cap, memory card, or combined memory/battery card from your LOGO! and connect the cable to this socket. Connect the other end of the cable to the serial port of your PC.

### Connecting the USB PC cable (for LOGO! 0BA6 only)

You can also connect LOGO! to the PC with the LOGO! USB PC cable. For the cable's order number, refer to the Appendix "Order numbers (Page 363)".

Remove the cap or memory card, battery card, or combined memory/battery card from your LOGO! and connect the cable to this socket. Connect the other end of the cable to a USB port of your PC.

### Switching LOGO! to PC ↔ LOGO! mode

Switch the LOGO! with/without display to STOP from your PC (refer to the LOGO!Soft Comfort online help), or select the ESC / >Stop command on a device with display and confirm the entry with 'Yes'.

When LOGO! is in STOP and online with the PC, the following PC commands are accepted:

- Switch LOGO! to RUN
- Read/write the circuit program
- Read/write the summertime/wintertime

When you start the upload/download in STOP, the following display appears automatically:

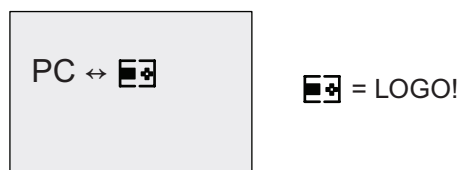

---

**Note**

You can switch earlier versions up to 0BA3 with/without display to PC ↔ LOGO mode as follows:

1. Switch off the power supply to LOGO!.
2. Remove the cover or the memory, battery, or combined memory/battery card and connect the cable to this socket.
3. Switch on power.

LOGO! switches automatically to PC ↔ LOGO mode.

The PC can now access LOGO! For information on this function, refer to the LOGO!Soft Comfort Online Help.

For more information on LOGO! versions without display, refer to the Appendix topic "LOGO! without display ("LOGO! Pure") (Page 351)".

---

### Closing the PC ↔ LOGO! mode

When the data transfer is completed, the connection to the PC is shut down automatically.

---

**Note**

If the circuit program created with LOGO!Soft Comfort is password protected, both the circuit program and the password are downloaded to LOGO!. The password prompt is enabled at the end of the data transfer.

The upload of a password protected program created in LOGO! is only possible after the correct password is entered in LOGO!Soft Comfort.

---

### Connecting a standard Ethernet cable (for LOGO! 0BA7 only)

To connect LOGO! 0BA7 to a PC, you need a standard Ethernet cable. Network communication between LOGO! 0BA7 and the PC takes place with Ethernet only.



---

**Note**

LOGO! sample applications are available to all our customers free of charge on the Siemens LOGO! website (<http://www.siemens.com/logo>) (go to Products & Solutions → Applications → Application Examples).

The examples provided are not guaranteed to be error-free; they serve as general information about the fields of application for LOGO!, and may be different from user-specific solutions. Siemens reserves the right to make changes.

The user operates the system at his own responsibility. For safety concerns, refer to the relevant national standards and system-related installation regulations.

---

On the Internet you can find the following sample applications, tips for further applications, and more:

- Irrigation system for greenhouse plants
- Conveyor control system
- Bending machine control system
- Shop window lighting
- Bell system (e.g., in a school)
- Parking lot surveillance
- Outdoor lighting
- Shutter control system
- Domestic outdoor and indoor lighting system
- Control system of a cream stirrer
- Sports hall lighting
- Constant load on 3 consumers
- Sequential control system for cable-welding machines for large cross-sections
- Step switch (e.g., for fans)
- Sequential control for boilers
- Control system for several pump sets with centralized operator control
- Cutting device (e.g., for detonating fuses)
- Monitoring periods of utilization, for example of a solar energy system
- Intelligent foot switches, for example, for speed preselection)
- Elevating platform controls
- Impregnation of textiles, heating and conveyor belt controls
- Silo-filling system
- Fill station with message text on the LOGO! TD that displays the sum of counted objects

On the Web you can also find descriptions and the corresponding circuit diagrams of the applications. You can read these \*.pdf files with the Adobe Acrobat Reader. If you have installed LOGO!Soft Comfort on your computer, you can simply click the disk icon to download the relevant circuit programs, which you can then adapt to suit your application and download to LOGO! directly via the PC cable.

## Benefits of LOGO!

LOGO! is a particularly useful feature:

- For replacing auxiliary switchgear with the integrated LOGO! functions
- For saving wiring and installation work - because LOGO! keeps the wiring "in its head."
- For reducing space requirements for components in the control cabinet/distribution box. A smaller control cabinet/distribution box may provide sufficient space.
- For adding or changing functions, without having to install additional switchgear or change the wiring.
- For offering your customers new, additional functions for domestic and commercial housing installations. Examples:
  - Domestic security systems: LOGO! switches on a lamp at regular intervals or opens and closes the shutters while you are on holiday.
  - Central heating: LOGO! runs the circulation pump only when water or heating is actually required.
  - Refrigerating systems: LOGO! can defrost refrigerating systems at regular intervals to save energy costs.
  - You can illuminate aquaria and terraria on a time-dependent basis.

Last but not least, you can:

- Use commonly available switches and pushbuttons, which makes it easy to install a domestic system.
- Connect LOGO! directly to your domestic installation; the integrated power supply makes it possible.

## Do you want more Info?

For more information about LOGO!, see the Siemens web page (as mentioned in the first paragraph of the Note in this chapter).

## Do you have any suggestions?

There are definitely many more useful applications for LOGO!. If you know of one, please write to the following address or send it to the online Support Request (<http://www.siemens.com/automation/support-request>). Siemens will collect all the suggestions made and distribute as many of them as possible. Your suggestions are valuable to Siemens.

Write to:

Siemens AG  
A&D AS FA PS4  
PO box 48 48  
D-90327 Nuremberg

## Technical data

### A.1 General technical data

Criterion	Tested in accordance with	Values
<b>LOGO! Base Modules (0BA6)</b> (LOGO! Basic or LOGO! Pure) Dimensions (WxHxD) Weight Installation		72 x 90 x 55 mm Approx. 190 g on a 35 mm profile rail 4 module widths or wall mounting
<b>LOGO! Base Modules (0BA7)</b> (LOGO! Basic) Dimensions (WxHxD) Weight Installation		107 x 90 x 55 mm Approx. 265 g on a 35 mm profile rail 6 module widths or wall mounting
<b>LOGO! expansion modules</b> <b>DM8..., AM...</b> Dimensions (WxHxD) Weight Installation		36 x 90 x 53 mm Approx. 90 g on a 35 mm profile rail 2 module widths or wall mounting
<b>LOGO! TD (Text Display)</b>		128.2 x 86 x 38.7 mm Approx. 220g Bracket mounting
<b>LOGO! expansion modules DM16...</b> Dimensions (WxHxD) Weight Installation		72 x 90 x 53 mm Approx. 190 g on a 35 mm profile rail 4 module widths or wall mounting
<b>Climatic conditions</b>		
Ambient temperature Horizontal installation Vertical installation	Low temperature to IEC 60068-2-1 High temperature to IEC 60068-2-2	0 ... 55 °C 0 ... 55 °C
Storage/shipping		- 40 °C... +70 °C
Relative humidity	IEC 60068-2-30	From 10 to 95 % no condensation
Air pressure		795 ... 1080 hPa
Pollutants	IEC 60068-2-42 IEC 60068-2-43	SO <sub>2</sub> 10 cm <sup>3</sup> /m <sup>3</sup> , 10 days H <sub>2</sub> S 1 cm <sup>3</sup> /m <sup>3</sup> , 10 days

A.1 General technical data

Criterion	Tested in accordance with	Values
<b>Ambient mechanical conditions</b>		
Degree of protection		IP 20 for LOGO! Base Modules, expansion modules, and the LOGO! TD excluding the TD front panel IP 65 for LOGO! TD front panel
Vibrations:	IEC 60068-2-6	5 ... 8.4 Hz (constant amplitude 3.5 mm) 8.4 ... 150 Hz (constant acceleration 1 g)
Shock	IEC 60068-2-27	18 shocks (half-sine wave 15g/11 ms)
Free fall (packaged)	IEC 60068-2-32	0.3 m
<b>Electromagnetic compatibility (EMC)</b>		
Noise emission	EN 55011/A EN 55022/B EN 50081-1 (domestic area)	Limit class B group 1
Electrostatic discharge	IEC 61000-4-2 Severity 3	8 kV air discharge 6 kV contact discharge
Electromagnetic fields	IEC 61000-4-3	Field strength 1 V/m and 10 V/m
HF currents on cables and cable shielding	IEC 61000-4-6	10 V
Burst pulses	IEC 61000-4-4Severity 3	2 kV (supply and signal lines)
High-energy surge pulse (applies only to LOGO! 230 ...)	IEC 61000-4-5Severity 3	1 kV (power lines) symmetrical 2 kV (power lines) asymmetrical
<b>Safety to IEC</b>		
Clearance and creepage distance rating	IEC 60664, IEC 61131-2, EN 50178 cULus to UL 508, CSA C22.2 No. 142 With LOGO! 230 R/RC, also IEC60730-1	Fulfilled
Insulation strength	IEC 61131-2	Fulfilled
<b>Cycle time</b>		
Cycle time per function		< 0.1 ms
<b>Startup</b>		
Startup time at power-up		typ. 9 s

## A.2 Technical data: LOGO! 230...

	LOGO! 230RC LOGO! 230RCo	LOGO! 230RCE
<b>Power supply</b>		
Input voltage	115 ... 240 V AC/DC	115 ... 240 V AC/DC
Permissible range	85 ... 265 V AC 100 ... 253 V DC	85 ... 265 V AC 100 ... 253 V DC
Permissible mains frequency	47 ... 63 Hz	47 ... 63 Hz
Power consumption		
<ul style="list-style-type: none"> <li>• 115 V AC</li> <li>• 240 V AC</li> <li>• 115 V DC</li> <li>• 240 V DC</li> </ul>	<ul style="list-style-type: none"> <li>• 15 ... 40 mA</li> <li>• 15 ... 25 mA</li> <li>• 10 ... 25 mA</li> <li>• 6 ... 15 mA</li> </ul>	<ul style="list-style-type: none"> <li>• 15 ... 40 mA</li> <li>• 15 ... 25 mA</li> <li>• 10 ... 25 mA</li> <li>• 6 ... 15 mA</li> </ul>
Voltage failure buffering		
<ul style="list-style-type: none"> <li>• 115 V AC/DC</li> <li>• 240 V AC/DC</li> </ul>	<ul style="list-style-type: none"> <li>• typ. 10 ms</li> <li>• typ. 20 ms</li> </ul>	<ul style="list-style-type: none"> <li>• typ. 10 ms</li> <li>• typ. 20 ms</li> </ul>
Power loss at		
<ul style="list-style-type: none"> <li>• 115 V AC</li> <li>• 240 V AC</li> <li>• 115 V DC</li> <li>• 240 V DC</li> </ul>	<ul style="list-style-type: none"> <li>• 1.7 ... 4.6 W</li> <li>• 3.6 ... 6.0 W</li> <li>• 1.1... 2.9 W</li> <li>• 1.4 ... 3.6 W</li> </ul>	<ul style="list-style-type: none"> <li>• 1.7 ... 4.6 W</li> <li>• 3.6 ... 6.0 W</li> <li>• 1.1 ... 2.9 W</li> <li>• 1.4 ... 3.6 W</li> </ul>
Backup of the real-time clock at 25 °C	typ. 80 hours without battery card typ. 2 years with battery card	typ. 20 days
Accuracy of the real-time clock	typ. ± 2 s / day	typ. ± 2 s / day
<b>Digital inputs</b>		
Number	8	8
Electrical isolation	No	No
Number of high speed inputs	0	0
Input frequency		
<ul style="list-style-type: none"> <li>• Normal input</li> <li>• High speed input</li> </ul>	<ul style="list-style-type: none"> <li>• max. 4 Hz</li> <li>• --</li> </ul>	<ul style="list-style-type: none"> <li>• max. 4 Hz</li> <li>• --</li> </ul>
Max. continuous permissible voltage	265 V AC 253 V DC	265 V AC 253 V DC
Input voltage L1		
<ul style="list-style-type: none"> <li>• Signal 0</li> <li>• Signal 1</li> <li>• Signal 0</li> <li>• Signal 1</li> </ul>	<ul style="list-style-type: none"> <li>• &lt; 40 V AC</li> <li>• &gt; 79 V AC</li> <li>• &lt; 30 V DC</li> <li>• &gt; 79 V DC</li> </ul>	<ul style="list-style-type: none"> <li>• &lt; 40 V AC</li> <li>• &gt; 79 V AC</li> <li>• &lt; 30 V DC</li> <li>• &gt; 79 V DC</li> </ul>

	LOGO! 230RC LOGO! 230RCo	LOGO! 230RCE
Input current at <ul style="list-style-type: none"> <li>• Signal 0</li> <li>• Signal 1</li> <li>• Signal 0</li> <li>• Signal 1</li> </ul>	<ul style="list-style-type: none"> <li>• &lt; 0.03 mA AC</li> <li>• &gt; 0.08 mA AC</li> <li>• &lt; 0.03 mA DC</li> <li>• &gt; 0.12 mA DC</li> </ul>	<ul style="list-style-type: none"> <li>• &lt; 0.03 mA AC</li> <li>• &gt; 0.08 mA AC</li> <li>• &lt; 0.03 mA DC</li> <li>• &gt; 0.12 mA DC</li> </ul>
Delay time at 0 to 1: <ul style="list-style-type: none"> <li>• 120V AC</li> <li>• 240 V AC</li> <li>• 120 V DC</li> <li>• 240V DC</li> </ul> Delay time at 1 to 0: <ul style="list-style-type: none"> <li>• 120V AC</li> <li>• 240 V AC</li> <li>• 120 V DC</li> <li>• 240V DC</li> </ul>	<ul style="list-style-type: none"> <li>• typ. 50 ms</li> <li>• typ. 30 ms</li> <li>• typ. 25 ms</li> <li>• typ. 15 ms</li> <li>• typ. 65 ms</li> <li>• typ. 105 ms</li> <li>• typ. 95 ms</li> <li>• typ. 125 ms</li> </ul>	<ul style="list-style-type: none"> <li>• typ. 50 ms</li> <li>• typ. 30 ms</li> <li>• typ. 25 ms</li> <li>• typ. 15 ms</li> <li>• typ. 65 ms</li> <li>• typ. 105 ms</li> <li>• typ. 95 ms</li> <li>• typ. 125 ms</li> </ul>
Line length (unshielded)	max. 100 m	max. 100 m
<b>Digital outputs</b>		
Number	4	4
Output type	Relay outputs	Relay outputs
Electrical isolation	Yes	Yes
In groups of	1	1
Control of a digital input	Yes	Yes
Continuous current $I_{th}$	max. 10 A per relay	max. 10 A per relay
Surge current Incandescent lamp load (25000 switching cycles) at <ul style="list-style-type: none"> <li>• 230/240 V AC</li> <li>• 115/120 V AC</li> </ul>	max. 30 A <ul style="list-style-type: none"> <li>• 1000 W</li> <li>• 500 W</li> </ul>	max. 30 A <ul style="list-style-type: none"> <li>• 1000 W</li> <li>• 500 W</li> </ul>
Fluorescent tubes with ballast (25000 switching cycles)	10 x 58 W (at 230/240 V AC)	10 x 58 W (at 230/240 V AC)
Fluorescent tubes, conventionally compensated (25000 switching cycles)	1 x 58 W (at 230/240 V AC)	1 x 58 W (at 230/240 V AC)
Fluorescent tubes, uncompensated (25000 switching cycles)	10 x 58 W (at 230/240 V AC)	10 x 58 W (at 230/240 V AC)
Short circuit-proof cos 1	Power protection B16, 600A	Power protection B16, 600A
Short circuit-proof cos 0.5 to 0.7	Power protection B16, 900A	Power protection B16, 900A
Derating	none; across the entire temperature range	none; across the entire temperature range
Parallel output circuits for power increase	Not permitted	Not permitted

	LOGO! 230RC LOGO! 230RCo	LOGO! 230RCE
Protection of output relay (if desired)	max. 16 A, characteristic B16	max. 16 A, characteristic B16
<b>Switching rate</b>		
Mechanical	10 Hz	10 Hz
Ohmic load/lamp load	2 Hz	2 Hz
Inductive load	0.5 Hz	0.5 Hz

Notice: For fluorescent lamps with capacitors, the technical data of fluorescent lamp ballasts must also be considered. If the maximum allowed surge current is exceeded, fluorescent lamps must be switched with appropriate contactor relays.

The data was determined with the following devices:

Siemens fluorescent tubes 58W VVG 5LZ 583 3-1 uncompensated.

Siemens fluorescent tubes 58W VVG 5LZ 583 3-1 parallel compensated with 7 $\mu$ F.

Siemens fluorescent tubes 58W VVG 5LZ 501 1-1N with ballast.

### A.3 Technical data: LOGO! DM8 230R and LOGO! DM16 230R

	LOGO! DM8 230R	LOGO! DM16 230R
<b>Power supply</b>		
Input voltage	115...240 V AC/DC	115 ... 240 V AC/DC
Permissible range	85 ... 265 V AC 100 ... 253 V DC	85 ... 265 V AC 100 ... 253 V DC
Permissible mains frequency	47 ... 63 Hz	
Power consumption		
<ul style="list-style-type: none"> <li>• 115 V AC</li> <li>• 240 V AC</li> <li>• 115 V DC</li> <li>• 240 V DC</li> </ul>	<ul style="list-style-type: none"> <li>• 10 ... 30 mA</li> <li>• 10 ... 20 mA</li> <li>• 5 ... 15 mA</li> <li>• 5 ... 10 mA</li> </ul>	<ul style="list-style-type: none"> <li>• 10 ... 60 mA</li> <li>• 10 ... 40 mA</li> <li>• 5 ... 25 mA</li> <li>• 5 ... 20 mA</li> </ul>
Voltage failure buffering		
<ul style="list-style-type: none"> <li>• 115 V AC/DC</li> <li>• 240 V AC/DC</li> </ul>	<ul style="list-style-type: none"> <li>• typ. 10 ms</li> <li>• typ. 20 ms</li> </ul>	<ul style="list-style-type: none"> <li>• typ. 10 ms</li> <li>• typ. 20 ms</li> </ul>
Power loss at		
<ul style="list-style-type: none"> <li>• 115 V AC</li> <li>• 240 V AC</li> <li>• 115 V DC</li> <li>• 240 V DC</li> </ul>	<ul style="list-style-type: none"> <li>• 1.1 ... 3.5 W</li> <li>• 2.4 ... 4.8 W</li> <li>• 0.5 ... 1.8 W</li> <li>• 1.2 ... 2.4 W</li> </ul>	<ul style="list-style-type: none"> <li>• 1.1 ... 4.5 W</li> <li>• 2.4 ... 5.5 W</li> <li>• 0.6 ... 2.9 W</li> <li>• 1.2 ... 4.8 W</li> </ul>
<b>Digital inputs</b>		
Number	4	8
Electrical isolation	No	No
Number of high speed inputs	0	0
Input frequency		
<ul style="list-style-type: none"> <li>• Normal input</li> <li>• High speed input</li> </ul>	<ul style="list-style-type: none"> <li>• max. 4 Hz</li> <li>• --</li> </ul>	<ul style="list-style-type: none"> <li>• max. 4 Hz</li> <li>• --</li> </ul>
Max. continuous permissible voltage	265 V AC 253 V DC	265 V AC 253 V DC
Input voltage L1		
<ul style="list-style-type: none"> <li>• Signal 0</li> <li>• Signal 1</li> <li>• Signal 0</li> <li>• Signal 1</li> </ul>	<ul style="list-style-type: none"> <li>• &lt; 40 V AC</li> <li>• &gt; 79 V AC</li> <li>• &lt; 30 V DC</li> <li>• &gt; 79 V DC</li> </ul>	<ul style="list-style-type: none"> <li>• &lt; 40 V AC</li> <li>• &gt; 79 V AC</li> <li>• &lt; 30 V DC</li> <li>• &gt; 79 V DC</li> </ul>
Input current at		
<ul style="list-style-type: none"> <li>• Signal 0</li> <li>• Signal 1</li> <li>• Signal 0</li> <li>• Signal 1</li> </ul>	<ul style="list-style-type: none"> <li>• &lt; 0.03 mA AC</li> <li>• &gt; 0.08 mA AC</li> <li>• &lt; 0.03 mA DC</li> <li>• &gt; 0.12 mA DC</li> </ul>	<ul style="list-style-type: none"> <li>• &lt; 0.05 mA AC</li> <li>• &gt; 0.08 mA AC</li> <li>• &lt; 0.05 mA DC</li> <li>• &gt; 0.12 mA DC</li> </ul>



	LOGO! DM8 230R	LOGO! DM16 230R
Delay time at 0 to 1:		
<ul style="list-style-type: none"> <li>• 120V AC</li> <li>• 240 V AC</li> <li>• 120 V DC</li> <li>• 240V DC</li> </ul>	<ul style="list-style-type: none"> <li>• typ. 50 ms</li> <li>• typ. 30 ms</li> <li>• typ. 25 ms</li> <li>• typ. 15 ms</li> </ul>	<ul style="list-style-type: none"> <li>• typ. 50 ms</li> <li>• typ. 30 ms</li> <li>• typ. 25 ms</li> <li>• typ. 15 ms</li> </ul>
Delay time at 1 to 0:		
<ul style="list-style-type: none"> <li>• 120V AC</li> <li>• 240 V AC</li> <li>• 120 V DC</li> <li>• 240V DC</li> </ul>	<ul style="list-style-type: none"> <li>• typ. 65 ms</li> <li>• typ. 105 ms</li> <li>• typ. 95 ms</li> <li>• typ. 125 ms</li> </ul>	<ul style="list-style-type: none"> <li>• typ. 65 ms</li> <li>• typ. 105 ms</li> <li>• typ. 95 ms</li> <li>• typ. 125 ms</li> </ul>
Line length (unshielded)	max. 100 m	max. 100 m
<b>Digital outputs</b>		
Number	4	8
Output type	Relay outputs	Relay outputs
Electrical isolation	Yes	Yes
In groups of	1	1
Control of a digital input	Yes	Yes
Continuous current $I_{th}$	max. 5 A per relay	max. 5 A per relay
Surge current	max. 30 A	max. 30 A
Incandescent lamp load (25000 switching cycles) at:		
230/240 V AC	1000 W	1000 W
115/120 V AC	500 W	500 W
Fluorescent tubes with ballast (25000 switching cycles)	10 x 58 W (at 230/240 V AC)	10 x 58 W (at 230/240 V AC)
Fluorescent tubes, conventionally compensated (25000 switching cycles)	1 x 58 W (at 230/240 V AC)	1 x 58 W (at 230/240 V AC)
Fluorescent tubes, uncompensated (25000 switching cycles)	10 x 58 W (at 230/240 V AC)	10 x 58 W (at 230/240 V AC)
Short circuit-proof cos 1	Power protection B16, 600A	Power protection B16, 600A
Short circuit-proof cos 0.5 to 0.7	Power protection B16, 900A	Power protection B16, 900A
Derating	none; across the entire temperature range	none; across the entire temperature range
Parallel output circuits for power increase	Not permitted	Not permitted
Protection of output relay (if desired)	max. 16 A, characteristic B16	max. 16 A, characteristic B16
<b>Switching rate</b>		
Mechanical	10 Hz	10 Hz
Ohmic load/lamp load	2 Hz	2 Hz
Inductive load	0.5 Hz	0.5 Hz

A.4 Technical data: LOGO! 24...

Notice: For fluorescent lamps with capacitors, the technical data of fluorescent lamp ballasts must also be considered. If the maximum allowed surge current is exceeded, fluorescent lamps must be switched with appropriate contactor relays.

The data was determined with the following devices:  
 Siemens fluorescent tubes 58W VVG 5LZ 583 3-1 uncompensated.  
 Siemens fluorescent tubes 58W VVG 5LZ 583 3-1 parallel compensated with 7µF.  
 Siemens fluorescent tubes 58W VVG 5LZ 501 1-1N with ballast.

A.4 Technical data: LOGO! 24...

	LOGO! 24 LOGO! 24o	LOGO! 24C LOGO! 24Co
<b>Power supply</b>		
Input voltage	24 V DC	24 V DC
Permissible range	20.4 ... 28.8 V DC	20.4 ... 28.8 V DC
Reverse polarity protection	Yes	Yes
Permissible mains frequency	--	--
Power consumption from 24 V DC	40 ... 75 mA 0.3 A per output	40 ... 75 mA 0.3 A per output
Voltage failure buffering		
Power loss at 24 V	1.0 ... 1.8 W	1.0 ... 1.8 W
Backup of the real-time clock at 25 °C	no clock available	typ. 80 hours without battery card typ. 2 years with battery card
Accuracy of the real-time clock	no clock available	typ. ± 2 s / day
<b>Digital inputs</b>		
Number	8	8
Electrical isolation	No	No
Number of high speed inputs	4 (I3, I4, I5, I6)	4 (I3, I4, I5, I6)
Input frequency	<ul style="list-style-type: none"> <li>• Normal input</li> <li>• High speed input</li> </ul>	<ul style="list-style-type: none"> <li>• max. 4 Hz</li> <li>• max. 5 kHz</li> </ul>
Max. continuous permissible voltage	28.8 V DC	28.8 V DC
Input voltage	L+	L+
Signal 0	< 5 V DC	< 5 V DC
Signal 1	> 12 V DC	> 12 V DC
Input current at		
Signal 0	< 0.85 mA (I3...I6) < 0.05 mA (I1, I2, I7, I8)	< 0.85 mA (I3...I6) < 0.05 mA (I1, I2, I7, I8)
Signal 1	> 2 mA (I3... I6) > 0.15 mA (I1, I2, I7, I8)	> 2 mA (I3... I6) > 0.15 mA (I1, I2, I7, I8)

	LOGO! 24 LOGO! 24o	LOGO! 24C LOGO! 24Co
Delay time at 0 to 1	typ. 1.5 ms <1.0 ms (I3 ... I6)	typ. 1.5 ms <1.0 ms (I3 ... I6)
1 to 0	typ. 1.5 ms <1.0 ms (I3 ... I6)	typ. 1.5 ms <1.0 ms (I3 ... I6)
Line length (unshielded)	max. 100 m	max. 100 m
<b>Analog inputs</b>		
Number	4 (I1=AI3, I2=AI4, I7=AI1, I8=AI2)	4 (I1=AI3, I2=AI4, I7=AI1, I8=AI2)
Range	0 ... 10 V DC input impedance 72 kΩ	0 ... 10 V DC input impedance 72 kΩ
Cycle time for analog value generation	300 ms	300 ms
Line length (shielded and twisted)	max. 10 m	max. 10 m
Error limit	± 1.5% at FS	± 1.5% at FS
<b>Digital outputs</b>		
Number	4	4
Output type	Transistor, current-sourcing <sup>1)</sup>	Transistor, current-sourcing <sup>1)</sup>
Electrical isolation	No	No
In groups of	--	--
Control of a digital input	Yes	Yes
Output voltage	≤ Supply voltage	≤ Supply voltage
Output current	max. 0.3 A	max. 0.3 A
Short circuit-proof and overload-proof	Yes	Yes
Short circuit current limitation	Approx. 1 A	Approx. 1 A
Derating	none; across the entire temperature range	none; across the entire temperature range
Short circuit-proof cos 1	--	--
Short circuit-proof cos 0.5 to 0.7	--	--
Parallel output circuit for power increase	Not permitted	Not permitted
Protection of output relay (if desired)	--	--
<b>Switching rate <sup>2)</sup></b>		
Mechanical	--	--
Electrical	10 Hz	10 Hz

A.5 Technical data: LOGO! DM8 24 and LOGO! DM16 24

	LOGO! 24 LOGO! 24o	LOGO! 24C LOGO! 24Co
Ohmic load/lamp load	10 Hz	10 Hz
Inductive load	0.5 Hz	0.5 Hz

- 1) When LOGO! 24/24o, LOGO! 24C/24Co, LOGO! DM8 24 or LOGO! DM16 24 are switched on, signal 1 is sent to the digital outputs for about 50 µs. Take this into account, especially when using devices that react to short pulses.
- 2) The maximum switching rate is only dependent on the switching program's cycle time.

A.5 Technical data: LOGO! DM8 24 and LOGO! DM16 24

	LOGO! DM8 24	LOGO! DM16 24
<b>Power supply</b>		
Input voltage	24 V DC	24 V DC
Permissible range	20.4 ... 28.8 V DC	20.4 ... 28.8 V DC
Reverse polarity protection	Yes	Yes
Permissible mains frequency	--	--
Power consumption from 24 V DC	30 ... 45 mA 0.3 A per output	30 ... 45 mA 0.3 A per output
Power loss at 24 V	0.8 ... 1.1 W	0.8 ... 1.7 W
<b>Digital inputs</b>		
Number	4	8
Electrical isolation	No	No
Number of high speed inputs	0	0
Input frequency		
• Normal input	• max. 4 Hz	• max. 4 Hz
• High speed input	• --	• --
Max. continuous permissible voltage	28.8 V DC	28.8 V DC
Input voltage	L+	L+
• Signal 0	• < 5 V DC	• < 5 V DC
• Signal 1	• > 12 V DC	• > 12 V DC
Input current at		
• Signal 0	• < 0.85 mA	• < 0.85 mA
• Signal 1	• > 2 mA	• > 2 mA
Delay time at		
• 0 to 1	• typ. 1.5 ms	• typ. 1.5 ms
• 1 to 0	• typ. 1.5 ms	• typ. 1.5 ms
Line length (unshielded)	max. 100 m	max. 100 m
<b>Digital outputs</b>		

	LOGO! DM8 24	LOGO! DM16 24
Number	4	8
Output type	Transistor, current-sourcing <sup>1)</sup>	Transistor, current-sourcing <sup>(1)</sup>
Electrical isolation	No	No
In groups of	--	--
Control of a digital input	Yes	Yes
Output voltage	≤ Supply voltage	≤ Supply voltage
Output current	max. 0.3 A	max. 0.3 A
Short circuit-proof and overload-proof	Yes	Yes
Short circuit current limitation	Approx. 1 A	Approx. 1 A
Derating	none; across the entire temperature range	none; across the entire temperature range
Short circuit-proof cos 1	--	--
Short circuit-proof cos 0.5 to 0.7	--	--
Parallel output circuit for power increase	Not permitted	Not permitted
Protection of output relay (if desired)	--	--
<b>Switching rate</b>		
Mechanical	--	--
Electrical	10 Hz	10 Hz
Ohmic load/lamp load	10 Hz	10 Hz
Inductive load	0.5 Hz	0.5 Hz

<sup>1)</sup> When LOGO! 24/24o, LOGO! 24C/24Co, LOGO! DM8 24 or LOGO! DM16 24 are switched on, signal 1 is sent to the digital outputs for about 50 µs. Take this into account, especially when using devices that react to short pulses.



	LOGO! 24RC LOGO! 24RCo
Range	--
max. Input voltage	--
<b>Digital outputs</b>	
Number	4
Output type	Relay outputs
Electrical isolation	Yes
In groups of	1
Control of a digital input	Yes
Continuous current $I_{th}$	max. 10 A per relay
Surge current	max. 30 A
Incandescent lamp load (25000 switching cycles) at	1000 W
Fluorescent tubes with ballast (25000 switching cycles)	10 x 58 W
Fluorescent tubes, conventionally compensated (25000 switching cycles)	1 x 58 W
Fluorescent tubes, uncompensated (25000 switching cycles)	10 x 58 W
Derating	none; across the entire temperature range
Short circuit-proof cos 1	Power protection B16, 600A
Short circuit-proof cos 0.5 to 0.7	Power protection B16, 900A
Parallel output circuits for power increase	Not permitted
Protection of output relay (if desired)	max. 16 A, characteristic B16
<b>Switching rate</b>	
Mechanical	10 Hz
Ohmic load/lamp load	2 Hz
Inductive load	0.5 Hz

Notice: For fluorescent lamps with capacitors, the technical data of fluorescent lamp ballasts must also be considered. If the maximum allowed surge current is exceeded, fluorescent lamps must be switched with appropriate contactor relays.

The data was determined with the following devices:

Siemens fluorescent tubes 58W VVG 5LZ 583 3-1 uncompensated.

Siemens fluorescent tubes 58W VVG 5LZ 583 3-1 parallel compensated with 7 $\mu$ F.

Siemens fluorescent tubes 58W VVG 5LZ 501 1-1N with ballast.

## A.7 Technical data: LOGO! DM8 24R and LOGO! DM16 24R

	LOGO! DM8 24R	LOGO! DM16 24R
<b>Power supply</b>		
Input voltage	24 V AC/DC	24 V DC
Permissible range	20.4 ... 26.4 V AC 20.4 ... 28.8 V DC	20.4 ... 28.8 V DC
Reverse polarity protection	--	--
Permissible mains frequency	47 ... 63 Hz	
Power consumption		
<ul style="list-style-type: none"> <li>• 24 V AC</li> <li>• 24 V DC</li> </ul>	<ul style="list-style-type: none"> <li>• 40 ... 110 mA</li> <li>• 20 ... 75 mA</li> </ul>	<ul style="list-style-type: none"> <li>• 30 ... 90 mA</li> </ul>
Voltage failure buffering	typ. 5 ms	typ. 5 ms
Power loss		
<ul style="list-style-type: none"> <li>• 24 V AC</li> <li>• 24 V DC</li> </ul>	<ul style="list-style-type: none"> <li>• 0.9 ... 2.7 W</li> <li>• 0.4 ... 1.8 W</li> </ul>	<ul style="list-style-type: none"> <li>• 0.7 ... 2.5 W</li> </ul>
<b>Digital inputs</b>		
Number	4, optional P action or N action	8
Electrical isolation	No	No
Number of high speed inputs	0	0
Input frequency		
<ul style="list-style-type: none"> <li>• Normal input</li> <li>• High speed input</li> </ul>	<ul style="list-style-type: none"> <li>• max. 4 Hz</li> <li>• --</li> </ul>	<ul style="list-style-type: none"> <li>• max. 4 Hz</li> <li>• --</li> </ul>
Max. continuous permissible voltage	26.4 V AC 28.8 V DC	28.8 V DC
Input voltage	L	
<ul style="list-style-type: none"> <li>• Signal 0</li> <li>• Signal 1</li> </ul>	<ul style="list-style-type: none"> <li>• &lt; 5 V AC/DC</li> <li>• &gt; 12 V AC/DC</li> </ul>	<ul style="list-style-type: none"> <li>• &lt; 5 V DC</li> <li>• &gt; 12 V DC</li> </ul>
Input current at		
<ul style="list-style-type: none"> <li>• Signal 0</li> <li>• Signal 1</li> </ul>	<ul style="list-style-type: none"> <li>• &lt; 1.0 mA</li> <li>• &gt; 2.5 mA</li> </ul>	<ul style="list-style-type: none"> <li>• &lt; 1.0 mA</li> <li>• &gt; 2.0 mA</li> </ul>
Delay time at		
<ul style="list-style-type: none"> <li>• 0 to 1</li> <li>• 1 to 0</li> </ul>	<ul style="list-style-type: none"> <li>• typ. 1.5 ms</li> <li>• typ. 15 ms</li> </ul>	<ul style="list-style-type: none"> <li>• typ. 1.5 ms</li> <li>• typ. 1.5 ms</li> </ul>
Line length (unshielded)	max. 100 m	max. 100 m
<b>Digital outputs</b>		
Number	4	8
Output type	Relay outputs	Relay outputs
Electrical isolation	Yes	Yes
In groups of	1	1
Control of a digital input	Yes	Yes



	LOGO! DM8 24R	LOGO! DM16 24R
Continuous current $I_{th}$	max. 5 A per relay	max. 5 A per relay
Surge current	max. 30 A	max. 30 A
Incandescent lamp load (25000 switching cycles) at	1000 W	1000 W
Fluorescent tubes with ballast (25000 switching cycles)	10 x 58 W	10 x 58 W
Fluorescent tubes, conventionally compensated (25000 switching cycles)	1 x 58 W	1 x 58 W
Fluorescent tubes, uncompensated (25000 switching cycles)	10 x 58 W	10 x 58 W
Derating	none; across the entire temperature range	none; across the entire temperature range
Short circuit-proof cos 1	Power protection B16, 600A	Power protection B16, 600A
Short circuit-proof cos 0.5 to 0.7	Power protection B16, 900A	Power protection B16, 900A
Parallel output circuits for power increase	Not permitted	Not permitted
Protection of output relay (if desired)	max. 16 A, characteristic B16	max. 16 A, characteristic B16
<b>Switching rate</b>		
Mechanical	10 Hz	10 Hz
Ohmic load/lamp load	2 Hz	2 Hz
Inductive load	0.5 Hz	0.5 Hz

Notice: For fluorescent lamps with capacitors, the technical data of fluorescent lamp ballasts must also be considered. If the maximum allowed surge current is exceeded, fluorescent lamps must be switched with appropriate contactor relays.

The data was determined with the following devices:

Siemens fluorescent tubes 58W VVG 5LZ 583 3-1 uncompensated.

Siemens fluorescent tubes 58W VVG 5LZ 583 3-1 parallel compensated with 7 $\mu$ F.

Siemens fluorescent tubes 58W VVG 5LZ 501 1-1N with ballast.

## A.8 Technical data: LOGO! 12/24... LOGO! DM8 12/24R

	LOGO! 12/24RC LOGO! 12/24RCo LOGO! 12/24RCE	LOGO! DM8 12/24R
<b>Power supply</b>		
Input voltage	12/24 V DC	12/24 V DC
Permissible range	10.8 ... 28.8 V DC	10.8 ... 28.8 V DC
Reverse polarity protection	Yes	Yes
Power consumption		
<ul style="list-style-type: none"> <li>• 12 V DC</li> <li>• 24 V DC</li> </ul>	<ul style="list-style-type: none"> <li>• 60 ... 175 mA</li> <li>• 40 ... 100 mA</li> </ul>	<ul style="list-style-type: none"> <li>• 30 ... 140 mA</li> <li>• 20 ... 75 mA</li> </ul>
Voltage failure buffering		
<ul style="list-style-type: none"> <li>• 12 V DC</li> <li>• 24 V DC</li> </ul>	<ul style="list-style-type: none"> <li>• typ. 2 ms</li> <li>• typ. 5 ms</li> </ul>	<ul style="list-style-type: none"> <li>• typ. 2 ms</li> <li>• typ. 5 ms</li> </ul>
Power loss		
<ul style="list-style-type: none"> <li>• 12 V DC</li> <li>• 24 V DC</li> </ul>	<ul style="list-style-type: none"> <li>• 0.7 ... 2.1 W</li> <li>• 1.0 ... 2.4 W</li> </ul>	<ul style="list-style-type: none"> <li>• 0.3 ... 1.7 W</li> <li>• 0.4 ... 1.8 W</li> </ul>
Backup of the real-time clock at 25 °C	<ul style="list-style-type: none"> <li>• LOGO! 12/24RC/RCo: typ. 80 hours without battery card typ. 2 years with battery card</li> <li>• LOGO! 12/24RCE: typ. 20 days</li> </ul>	--
Accuracy of the real-time clock	typ. $\pm 2$ s / day	--
Electrical isolation	No	No
<b>Digital inputs</b>		
Number	8	4
Electrical isolation	No	No
Number of high speed inputs	4 (I3, I4, I5, I6)	0
Input frequency		
<ul style="list-style-type: none"> <li>• Normal input</li> <li>• High speed input</li> </ul>	<ul style="list-style-type: none"> <li>• Max. 4 Hz</li> <li>• Max. 5 kHz</li> </ul>	<ul style="list-style-type: none"> <li>• max. 4 Hz</li> <li>• --</li> </ul>
Max. continuous permissible voltage	28.8 V DC	28.8 V DC
Input voltage L+		
<ul style="list-style-type: none"> <li>• Signal 0</li> <li>• Signal 1</li> </ul>	<ul style="list-style-type: none"> <li>• &lt; 5 V DC</li> <li>• &gt; 8.5 V DC</li> </ul>	<ul style="list-style-type: none"> <li>• &lt; 5 V DC</li> <li>• &gt; 8.5 V DC</li> </ul>

	LOGO! 12/24RC LOGO! 12/24RCo LOGO! 12/24RCE	LOGO! DM8 12/24R
Input current at		
• Signal 0	< 0.85 mA (I3...I6) < 0.05 mA (I1, I2, I7, I8)	< 0.85 mA
• Signal 1	> 1.5 mA (I3... I6) > 0.1 mA (I1, I2, I7, I8)	> 1.5 mA
Delay time at		
• 0 to 1	typ. 1.5 ms <1.0 ms (I3 ... I6)	typ. 1.5 ms
• 1 to 0	typ. 1.5 ms <1.0 ms (I3 ... I6)	typ. 1.5 ms
Line length (unshielded)	max. 100 m	max. 100 m
<b>Analog inputs</b>		
Number	4 (I1=AI3, I2=AI4, I7=AI1, I8=AI2)	--
Range	0 ... 10 V DC input impedance 72 kΩ	--
Cycle time for analog value generation	300 ms	--
Line length (shielded and twisted)	max. 10 m	--
Error limit	± 1.5 % at FS	--
<b>Digital outputs</b>		
Number	4	4
Output type	Relay outputs	Relay outputs
Electrical isolation	Yes	Yes
In groups of	1	1
Control of a digital input	Yes	Yes
Continuous current I <sub>th</sub> (per terminal)	max. 10 A per relay	max. 5 A per relay
Surge current	max. 30 A	max. 30 A
Incandescent lamp load (25000 switching cycles) at	1000 W	1000 W
Fluorescent tubes with ballast (25000 switching cycles)	10 x 58 W	10 x 58 W
Fluorescent tubes, conventionally compensated (25000 switching cycles)	1 x 58 W	1 x 58 W
Fluorescent tubes, uncompensated (25000 switching cycles)	10 x 58 W	10 x 58 W
Derating	none; across the entire temperature range	none; across the entire temperature range
Short circuit-proof cos 1	Power protection B16, 600A	Power protection B16, 600A

Technical data

A.8 Technical data: LOGO! 12/24... LOGO! DM8 12/24R

	LOGO! 12/24RC LOGO! 12/24RC <sub>o</sub> LOGO! 12/24RCE	LOGO! DM8 12/24R
Short circuit-proof cos 0.5 to 0.7	Power protection B16, 900A	Power protection B16, 900A
Parallel output circuits for power increase	Not permitted	Not permitted
Protection of output relay (if desired)	max. 16 A, characteristic B16	max. 16 A, characteristic B16
<b>Switching rate</b>		
Mechanical	10 Hz	10 Hz
Ohmic load/lamp load	2 Hz	2 Hz
Inductive load	0.5 Hz	0.5 Hz

Notice: For fluorescent lamps with capacitors, the technical data of fluorescent lamp ballasts must also be considered. If the maximum allowed surge current is exceeded, fluorescent lamps must be switched with appropriate contactor relays.

The data was determined with the following devices:

Siemens fluorescent tubes 58W VVG 5LZ 583 3-1 uncompensated.

Siemens fluorescent tubes 58W VVG 5LZ 583 3-1 parallel compensated with 7µF.

Siemens fluorescent tubes 58W VVG 5LZ 501 1-1N with ballast.

## A.9 Switching capacity/service life of the relay outputs

Switching capacity and service life of the contacts with ohmic loading (heating):

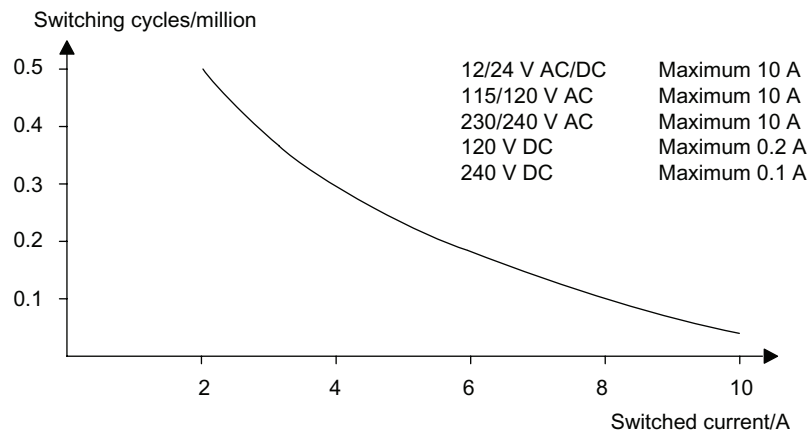

Switching capacity and service life of the contacts with high inductive load to IEC 947-5-1 DC 13/AC 15 (contactors, solenoid coils, motors):

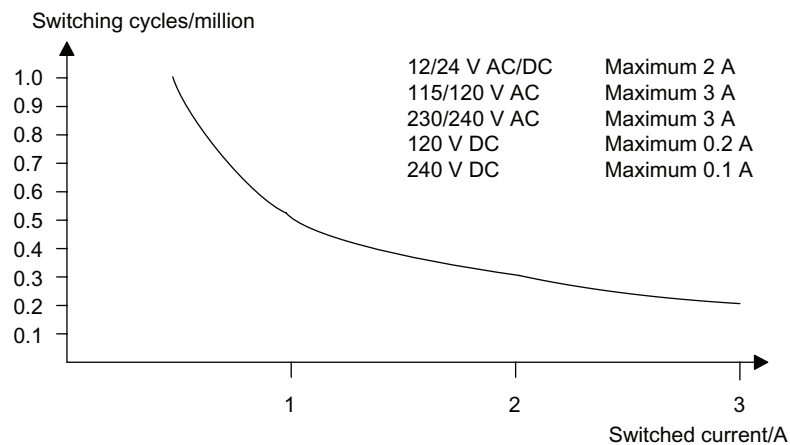

## A.10 Technical data: LOGO! AM2

LOGO! AM2	
<b>Power supply</b>	
Input voltage	12/24 V DC
Permissible range	10.8 ... 28.8 V DC
Power consumption	25 ... 50 mA
Voltage failure buffering	typ. 5 ms
Power loss at <ul style="list-style-type: none"> <li>• 12 V</li> <li>• 24 V</li> </ul>	<ul style="list-style-type: none"> <li>• 0.3 ... 0.6 W</li> <li>• 0.6 ... 1.2 W</li> </ul>
Electrical isolation	No
Reverse polarity protection	Yes
Ground terminal	for connecting ground and shielding of the analog measuring line
<b>Analog inputs</b>	
Number	2
Type	Unipolar
Input range	0 ... 10 V DC (input impedance 76 kΩ) or 0/4 ... 20 mA (input impedance <250 Ω)
Resolution	10 bit, normalized to 0 ... 1000
Cycle time for analog value generation	50 ms
Electrical isolation	No
Line length (shielded and twisted)	max. 10 m
Encoder supply voltage	none
Error limit	± 1.5 %
Interference frequency suppression	55 Hz

## A.11 Technical data: LOGO! AM2 PT100

LOGO! AM2 PT100	
<b>Power supply</b>	
Input voltage	12/24 V DC
Permissible range	10.8 ... 28.8 V DC
Power consumption	25 ... 50 mA
Voltage failure buffering	typ. 5 ms
Power loss at <ul style="list-style-type: none"> <li>• 12 V</li> <li>• 24 V</li> </ul>	<ul style="list-style-type: none"> <li>• 0.3 ... 0.6 W</li> <li>• 0.6 ... 1.2 W</li> </ul>
Electrical isolation	No
Reverse polarity protection	Yes
Ground terminal	for connecting ground and shielding of the measuring line
<b>Sensor inputs</b>	
Number	2
Type	RTD PT100
Connection of sensors <ul style="list-style-type: none"> <li>• 2-wire technique</li> <li>• 3-wire technique</li> </ul>	<ul style="list-style-type: none"> <li>• Yes</li> <li>• Yes</li> </ul>
Measurement range	-50 °C... +200 °C -58 °F ... +392 °F
Settings for the measurement display on the LOGO! Basic: <ul style="list-style-type: none"> <li>• 1 °C steps</li> <li>• 0.25 °C steps (rounded to one decimal)</li> <li>• 1 °F steps</li> <li>• 0.25 °F steps (rounded to one decimal)</li> </ul>	<ul style="list-style-type: none"> <li>• Offset: -50, Gain: 0.25</li> <li>• Offset: -500, Gain: 2.50</li> <li>• Offset: -58, Gain: 0.45</li> <li>• Offset: -580, Gain: 4.50</li> </ul>
Curve linearization	No
Measuring current I <sub>c</sub>	1.1 mA
Measurement rate	depends on the installation typical: 50 ms
Resolution	0.25 °C
Error limits <ul style="list-style-type: none"> <li>• 0 °C ... +200 °C</li> <li>• -50 °C ... +200 °C</li> </ul>	of the final measured value: <ul style="list-style-type: none"> <li>• ±1.0 %</li> <li>• ± 1.5 %</li> </ul>
Electrical isolation	No
Cable length (shielded)	max. 10 m
Interference frequency suppression	55 Hz

## A.12 Technical data: LOGO! AM2 RTD

LOGO! AM2 RTD	
<b>Power supply</b>	
Input voltage	12/24 V DC
Permissible range	10.8 ... 28.8 V DC
Power consumption	30 ... 40 mA
Voltage failure buffering	typ. 5 ms
Power loss at	
<ul style="list-style-type: none"> <li>• 12 V</li> <li>• 24 V</li> </ul>	<ul style="list-style-type: none"> <li>• 0.36 ... 0.48 W</li> <li>• 0.72 ... 0.96 W</li> </ul>
Electrical isolation	No
Reverse polarity protection	Yes
Ground terminal	for connecting ground and shielding of the measuring line
<b>Sensor inputs</b>	
Number	2
Type	PT100 or PT1000 with the default temperature coefficient of $\alpha = 0.003850$ for both types, or compatible sensors
Connection of sensors	
<ul style="list-style-type: none"> <li>• 2-wire technique</li> <li>• 3-wire technique</li> </ul>	<ul style="list-style-type: none"> <li>• Yes</li> <li>• Yes</li> </ul>
Measurement range	-50 °C... +200 °C -58 °F ... +392 °F
Settings for the measurement display on the LOGO! Basic:	
<ul style="list-style-type: none"> <li>• 1 °C steps</li> <li>• 0.25 °C steps (rounded to one decimal)</li> <li>• 1 °F steps</li> <li>• 0.25 °F steps (rounded to one decimal)</li> </ul>	<ul style="list-style-type: none"> <li>• Offset: -50, Gain: 0.25</li> <li>• Offset: -500, Gain: 2.50</li> <li>• Offset: -58, Gain: 0.45</li> <li>• Offset: -580, Gain: 4.50</li> </ul>
Curve linearization	No
Measuring current $I_c$	Pulse current signal: PT100: 1.141 mA (cycle time = 2.3 ms) PT1000: 0.5 mA (cycle time = 2.3 ms)
Measurement rate	depends on the installation typical: 50 ms
Resolution	0.25 °C
Error limits	of the final measured value:
<ul style="list-style-type: none"> <li>• 0 °C ... +200 °C</li> <li>• -50 °C ... 0 °C</li> </ul>	<ul style="list-style-type: none"> <li>• <math>\pm 2</math> °C</li> <li>• <math>\pm 3</math> °C</li> </ul>
Electrical isolation	No



LOGO! AM2 RTD	
Cable length (shielded)	max. 10 m
Interference frequency suppression	55 Hz

## A.13 Technical data: LOGO! AM2 AQ

LOGO! AM2 AQ	
<b>Power supply</b>	
Input voltage	24 V DC
Permissible range	20.4 ... 28.8 V DC
Power consumption	35 ...90 mA
Voltage failure buffering	typ. 5 ms
Power loss at 24 V	0.9 ... 2.2 W
Electrical isolation	No
Reverse polarity protection	Yes
Ground terminal	for connecting ground and shielding of the analog output line.
<b>Analog outputs</b>	
Number	2
Voltage range	0 ... 10 V DC
Voltage load	≥5 kΩ
Current output	0/4...20mA
Curreny load	≤250 Ω
Resolution	10 bit, normalized to 0 ... 1000
Cycle time for analog output	depending on installation (50 ms)
Electrical isolation	No
Line length (shielded and twisted)	max. 10 m
Error limit	Voltage output: ± 2.5 % FS
Short circuit protection	Voltage output: Yes (affect neighboring voltage output)
Overload protection	Voltage output: Yes (affect neighboring voltage output)

### Note

The 0/4 ... 20 mA current output is only possible when the module is used with a LOGO! 0BA6 or LOGO! 0BA7 Base Module.

## A.14 Technical data: CM EIB/KNX

<b>CM EIB/KNX</b>	
<b>Mechanical data</b>	
Dimensions (WxHxD)	36 x 90 x 55 mm
Weight	Approx. 107 g
Installation	on a 35 mm profile rail 2 module widths or wall mounting, must be mounted as the last module on the right of LOGO!
<b>Power supply</b>	
Input voltage	24 V AC/DC
Permissible range	-15% ... +10% AC -15% ... +20% DC
Power consumption from power supply	max. 25 mA
Power consumption via bus	5 mA
EIB data transmission rate	9600 baud
<b>Connections</b>	
Digital inputs (I)	virtual max. 16
Digital outputs (Q)	virtual max. 12
Analog inputs (AI)	virtual max. 8
Analog outputs (AQ)	virtual max. 2
Group addresses	max. 56
Associations	max. 56
<b>Climatic conditions</b>	
Climatic withstand capability	EN 50090-2-2
Ambient operating conditions	0 ... 55 °C natural convection
Storage and transport temperature	- 40 °C ... +70 °C
Relative humidity	95 % at +25 °C (not condensing)
<b>Electrical safety</b>	
Degree of protection	IP 20 (in accordance with EN 60529)
Interference suppression	EN 55011 (limit class B)
Certification	IEC 60730-1 IEC 61131-2
Overvoltage protection	Slow-blowing fuse 80 mA (recommended)
<b>Electromagnetic compatibility (EMC)</b>	
EMC requirements	Complies with EN 61000-6-1 and EN 61000-6-2
<b>Approval</b>	
	KNX/EIB certified UL 508 FM
<b>CE mark</b>	
	In accordance with the EMC guideline (residential and functional buildings), low voltage guideline

## A.15 Technical data: CM AS Interface

<b>CM AS Interface</b>	
<b>Mechanical data</b>	
Dimensions (WxHxD)	36 x 90 x 58 mm
Weight	Approx. 90 g
Installation	on a 35 mm profile rail 2 module widths or wall mounting, must be mounted as the last module on the right of LOGO!
<b>Power supply</b>	
Input voltage	30 V DC
Permissible range	26.5 ... 31.5 V DC
Reverse polarity protection	Yes
Total current drain	$I_{tot}$ max. 70 mA
<b>Connections</b>	
Digital inputs (I)	the next four inputs after the physical inputs of LOGO! ( $I_n \dots I_{n+3}$ )
Digital outputs (Q)	the next four outputs after the physical outputs of LOGO! ( $Q_n \dots Q_{n+3}$ )
I/O configuration (hex)	7
ID code (hex)	F
ID1 code (hex)	F (default, variable from 0 ... F)
ID2 code (hex)	F
Bus connection	AS interface in accordance with specification
Analog inputs (AI)	none
Analog outputs (AQ)	none
<b>Climatic conditions</b>	
Ambient operating conditions	0 °C ... +55 °C
Storage temperature	- 40 °C ... +70 °C
<b>Electrical safety</b>	
Electrical data	to AS interface specification
Degree of protection	IP 20
Interference suppression	Limit class A
<b>Approval</b>	
	IEC 61131-2 EN 50178 cULus to UL 508 CSA C22.2 No. 142

## A.16 Technical data: LOGO!Power 12 V

LOGO! Power 12 V is a primary-switched power supply unit for LOGO! devices. Two current ranges are available.

	LOGO! Power 12 V / 1.9 A	LOGO! Power 12 V / 4.5 A
<b>Input data</b>		
Input voltage	100 ... 240 V AC	
Permissible range	85 ... 264 V AC	
Permissible mains frequency	47 ... 63 Hz	
Voltage failure buffering	> 40 ms (at 187 V AC)	
Input current	0.53 ... 0.3 A	1.13 ... 0.61 A
Make current (25°C)	≤15 A	≤ 30 A
Device protection	Internal	
Recommended circuit breaker (IEC 898) in mains line	≥ 16 A characteristic B ≥ 10 A characteristic C	
<b>Output data</b>		
Output voltage	12 V DC	
Overall tolerance	±3 %	
Adjustment range	10.5 ... 16.1 V DC	
Residual ripple	< 200/300 mV <sub>pp</sub>	
Output current	1.9 A	4.5 A
Overcurrent limiting	typ. 2.5 A	typ. 5.9 A
Efficiency	typ. 80 %	typ. 85 %
Parallel circuit for power increase	Yes	
<b>Electromagnetic compatibility</b>		
Interference suppression	EN 50081-1, Class B to EN 55022	
Interference immunity	EN 61000-6-2, EN 61000-4-2/-3/-4/-5/-6/-11	
<b>Safety</b>		
Electrical isolation, primary/secondary	Yes, SELV (to EN 60950 and EN 50178)	
Safety class	II	
Degree of protection	IP 20 (to EN 60529)	
CE marking	Yes	
UL/cUL certification	Yes; UL 508 / UL 60950	
FM approval	Yes; Class I, Div. 2, T4	
GL approval	Yes	
<b>General details</b>		
Ambient temperature range	-20 ... +55°C, natural convection	
Storage and shipping temperature	-40 ... +70°C	
Connections at input	One terminal (1 x 2.5 mm <sup>2</sup> or 2 x 1.5 mm <sup>2</sup> ) per L1 and N	
Connections at output	Two terminals (1x.2.5 mm <sup>2</sup> or 2 x 1.5 mm <sup>2</sup> ) per + and -	
Installation	On 35 mm DIN rail, snap-on	
Dimensions in mm (WxHxD)	54 x 80 x 55	72 x 90 x 55
Approx. weight	0.2 kg	0.3 kg

## A.17 Technical data: LOGO!Power 24 V

LOGO! Power 24 V is a primary-switched power supply module for LOGO! devices. Two current ranges are available.

	LOGO! Power 24 V / 1.3 A	LOGO! Power 24 V / 2.5 A
<b>Input data</b>		
Input voltage	100 ... 240 V AC	
Permissible range	85 ... 264 V AC	
Permissible mains frequency	47 ... 63 Hz	
Voltage failure buffering	40 ms (at 187 V AC)	
Input current	0.70 ... 0.35 A	1.22 ... 0.66 A
Inrush current (25°C)	< 15 A	< 30 A
Device protection	Internal	
Recommended circuit breaker (IEC 898) in mains line	≥ 16 A characteristic B ≥ 10 A characteristic C	
<b>Output data</b>		
Output voltage	24 V DC	
Overall tolerance	± 3 %	
Adjustment range	22.2 ... 26.4 V DC	
Residual ripple	< 200/300 mV <sub>pp</sub>	
Output current	1.3 A	2.5 A
Overcurrent limiting	typ. 2.0 A	typ. 3.4 A
Efficiency	> 82 %	> 87 %
Parallel circuit for power increase	Yes	
<b>Electromagnetic compatibility</b>		
Interference suppression	EN 50081-1, Class B to EN 55022	
Interference immunity	EN 61000-6-2, EN 61000-4-2/-3/-4/-5/-6/-11	
<b>Safety</b>		
Electrical isolation, primary/secondary	Yes, SELV (to EN 60950 and EN 50178)	
Safety class	II	
Degree of protection	IP 20 (to EN 60529)	
CE marking	Yes	
UL/cUL certification	Yes; UL 508 / UL 60950	
FM approval	Yes; Class I, Div. 2, T4	
GL approval	Yes	
<b>General details</b>		
Ambient temperature range	-20 ... +55 °C, natural convection	
Storage and shipping temperature	-40 ... +70 °C	
Connections at input	One terminal (1 x. 2.5 mm <sup>2</sup> or 2 x 1.5 mm <sup>2</sup> ) per L1 and N	
Connections at output	Two terminals (1x.2.5 mm <sup>2</sup> or 2 x 1.5 mm <sup>2</sup> ) per + and -	

A.18 Technical data: LOGO! Contact 24/230

	LOGO! Power 24 V / 1.3 A	LOGO! Power 24 V / 2.5 A
Installation	On 35 mm DIN rail, snap-on	
Dimensions in mm (WxHxD)	54 x 80 x 55	72 x 90 x 55
Approx. weight	0.2 kg	0.3 kg

## A.18 Technical data: LOGO! Contact 24/230

LOGO! Contact 24 and LOGO! Contact 230 are switching modules for direct switching of ohmic loads up to 20 Amps and motors up to 4 kW (without noise emission, hum-free). Both modules have a built-in protective circuit for damping surges.

	LOGO! Contact 24	LOGO! Contact 230
Operating voltage	24 V DC	230 V AC; 50/60 Hz
<b>Switching capacity</b>		
Utilization category AC-1: Switching of ohmic loads at 55°C Operating current at 400 V Output with three-phase loads at 400 V	20 A 13 kW	
Utilization category AC-2, AC-3: Motor with slip ring induction/cage armature Operating current at 400 V Output with three-phase loads at 400 V	8.4 A 4 kW	
Short-circuit protection: Assignment type 1 Assignment type 2	25 A 10 A	
Connecting leads	Fine-wire with wire end ferrules Solid wire 2 x (0.75 to 2.5) mm <sup>2</sup> 2 x (1 to 2.5) mm <sup>2</sup> 1 x 4 mm <sup>2</sup>	
Dimensions (WxHxD)	36 x 72 x 55	
Ambient temperature	-25 ... +55 °C	
Storage temperature	-50 ... +80 °C	

## A.19 Technical data: LOGO! TD (Text Display)

LOGO! TD	
<b>Mechanical data</b>	
Dimensions (WxHxD)	128.2 x 86 x 38.7 mm
Weight	Approx. 220 g
Installation	Bracket mounting
Keyboard	Membrane keypad with 10 keys
Display	FSTN-Graphic Display with 128 x 64 (columns x rows), LED backlight
<b>Power supply</b>	
Input voltage	24 V AC/DC 12 V DC
Permissible range	20.4 ... 26.4 V AC 10.2 ... 28.8 V DC
Permissible mains frequency	47 ... 63 Hz
Power consumption	<ul style="list-style-type: none"> <li>• 12 V DC</li> <li>• 24 V DC</li> <li>• 24 V AC</li> </ul>
	<ul style="list-style-type: none"> <li>• typ. 65 mA</li> <li>• typ. 40 mA</li> <li>• typ. 90 mA</li> </ul>
Data transmission rate	19,200 baud
<b>Degree of protection</b>	
	IP20 for LOGO! TD excluding front panel IP65 for LOGO! TD front panel
<b>Connection distance</b>	
	≤ 2.5 m (LOGO! TD cable only), max. 10 m (LOGO! TD cable + standard Sub-D cable)
<b>LCD Display and Backlight</b>	
Backlight lifetime <sup>1)</sup>	20,000 hours
Display lifetime <sup>2)</sup>	50,000 hours
<b>Mounting hole dimensions</b>	
Width x Height	(119.5+0.5mm) x (78.5+0.5mm)

<sup>1)</sup> Backlight lifetime is defined as: The final brightness is 50% of the original brightness.

<sup>2)</sup> Display lifetime is calculated under ordinary operating and storage conditions: room temperature (20 ±8° C), normal humidity below 65% relative humidity, and not in exposure to direct sunlight.

## A.20 Technical data: Battery information for LOGO! battery cards

<b>Battery information for LOGO! Battery cards</b>	
<b>Manufacturer</b>	Panasonic
<b>Type</b>	BR1220/1VCE
<b>Voltage</b>	3V
<b>Capacity</b>	35mAh
<b>Mechanical data</b>	
Dimensions	12.5mm x 1.6mm
Weight	0.9g



## Determining the cycle time

The program cycle is the complete execution of the circuit program, that is, primarily the reading in of the inputs, the processing of the circuit program and the subsequent reading out of the outputs. The cycle time is the time required to execute a circuit program once in full.

The time required for a program cycle can be determined using a short test program. This test program is created in LOGO! and returns a value during its execution in parameter assignment mode from which the current cycle time is derived.

### Test program

1. Create the test program by linking an output to a threshold trigger and connecting the trigger input with an inverted flag.

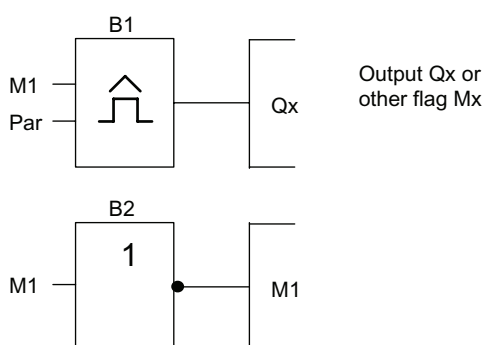

2. Configure the threshold trigger as shown below. A pulse is generated in each program cycle due to the inverted flag. The trigger interval is set to 2 seconds.

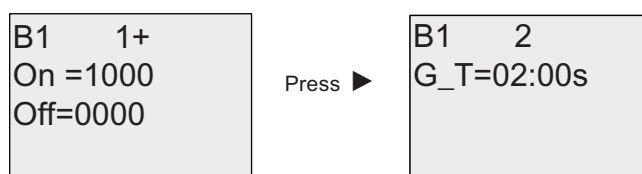

3. Now start the circuit program and switch LOGO! to parameter assignment mode. In this mode, view the trigger parameters.

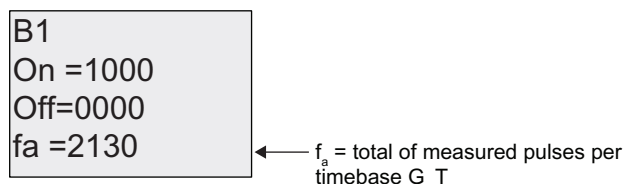

4. The reciprocal value of  $f_a$  is equivalent to the LOGO! execution time of the current circuit program in its memory.

$$1/f_a = \text{cycle time in s}$$

**Explanation**

The inverted flag block changes its output signal at each program execution. Thus, one logic level (high or low) width is exactly equivalent to the length of one cycle. Hence, a period lasts 2 cycles.

The threshold trigger indicates the ratio of periods per 2 seconds, which results in the ratio of cycles per second.

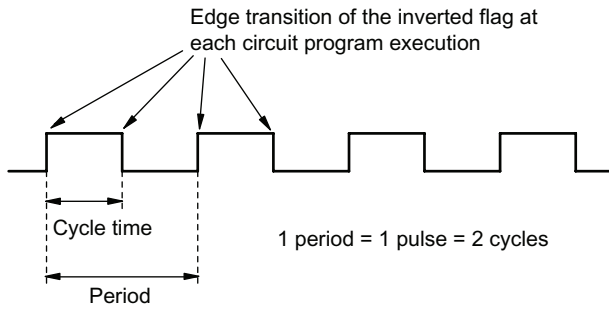

## LOGO! without display ("LOGO! Pure")

Because some specific applications do not require operator control and monitoring units such as buttons or a display, we provide the LOGO! 12/24RCo, LOGO! 24o, LOGO! 24Co, LOGO! 24RCo and LOGO! 230RCo versions without display.

View of a LOGO! 230RCo, for example:

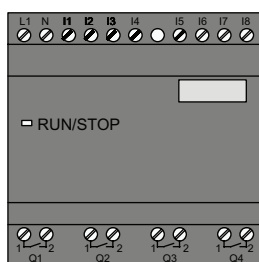

### Less is definitely more!

The versions without display offer you the following benefits:

- Even more cost-effective without the operating element
- Requires less switch cabinet space than conventional hardware
- Substantial benefits with regard to flexibility and prime costs compared to stand-alone electronic switchgear
- Of advantage even for applications in which merely two or three conventional switching devices can be replaced
- Very easy to use
- Access protected
- Compatible to LOGO! versions with display
- Offers the option to read data by means of LOGO!Soft Comfort

### Creating a circuit program without operator panel

There are two ways to create a circuit program for a LOGO! without display:

- You create the circuit program with LOGO!Soft Comfort on your PC and then download it to LOGO!.
- You download the circuit program from a LOGO! memory card or combined memory/battery card (Page 303) to your LOGO! without display.

## Operating characteristics

LOGO! is ready for operation when power is switched on. Switching off a LOGO! without display is equivalent to disconnecting the power supply, e.g. as if you were removing the plug.

The circuit program of LOGO!...o versions cannot be started or stopped by means of buttons. This is why the LOGO!...o versions have other startup characteristics:

## Startup characteristics

If there is no circuit program in LOGO! or on the inserted memory card or combined memory/battery card, LOGO! remains in STOP.

If there is a valid circuit program in LOGO! memory, the LOGO! automatically switches from STOP to RUN when power is switched on.

The circuit program on an inserted memory card or combined memory/battery card is automatically copied to LOGO!, immediately after power is switched on. The existing circuit program in LOGO! memory is overwritten. The system automatically changes from STOP to RUN.

Provided the PC cable is connected to LOGO! (Page 315), you can download the circuit program to LOGO! and start it by means of LOGO!Soft Comfort PC software.

## Operating status indication

Operating states, e.g. Power On, RUN and STOP are indicated by an LED on the front hood.

- Red LED: Power On/STOP
- Green LED: Power On/RUN

The red LED is lit after Power On and in all LOGO! states other than RUN. The green LED is lit when LOGO! is in RUN mode.

## Reading current data

LOGO!Soft Comfort provides an online test for reading the current data of all functions while the system is in RUN.

If your LOGO! without display holds a protected memory card or combined memory/battery card, you cannot read the current data unless you enter the correct password (Page 305) for the circuit program. The circuit program is otherwise deleted from LOGO! memory when you remove the memory card or combined memory/battery card to connect the PC cable.

## Deleting the circuit program

Use LOGO!Soft Comfort to delete the circuit program and password if a password exists.

## LOGO! menu structure

### D.1 LOGO! Basic

#### Menu overview

#### 0BA6

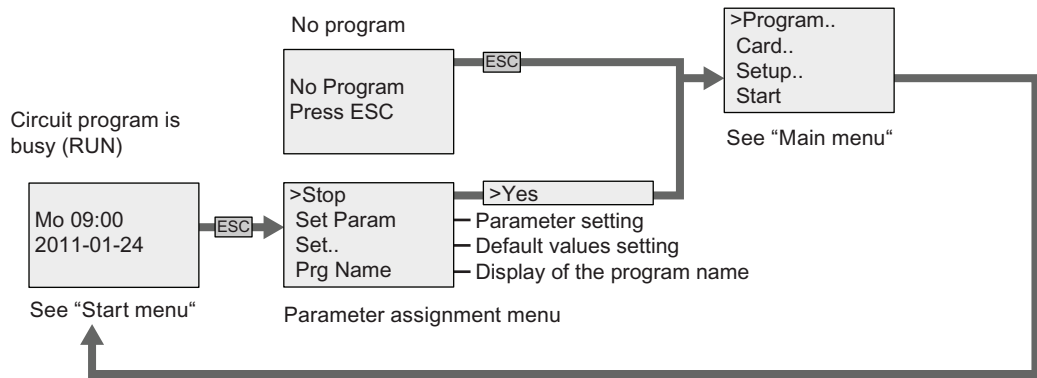

#### 0BA7

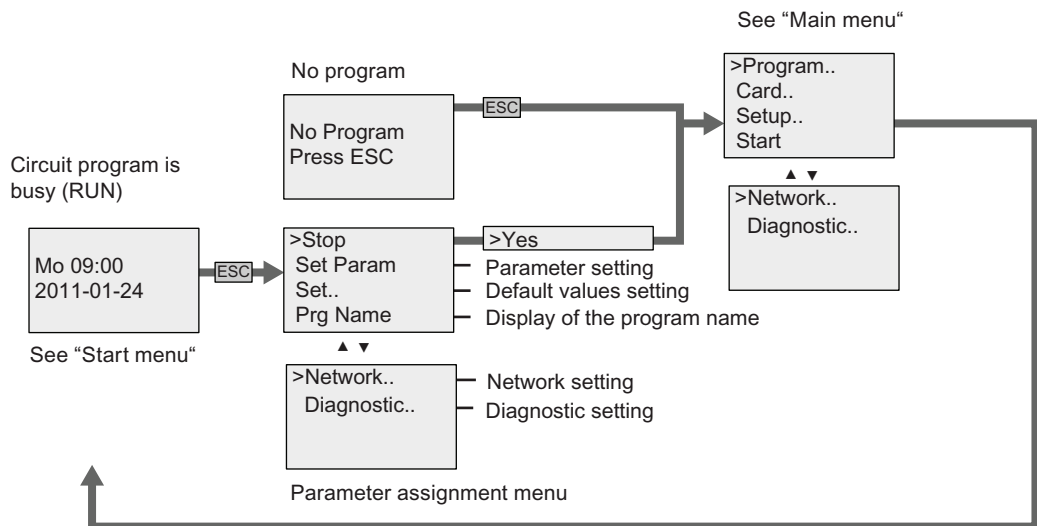

**Main menu (ESC / > Stop)**

**OBA6**

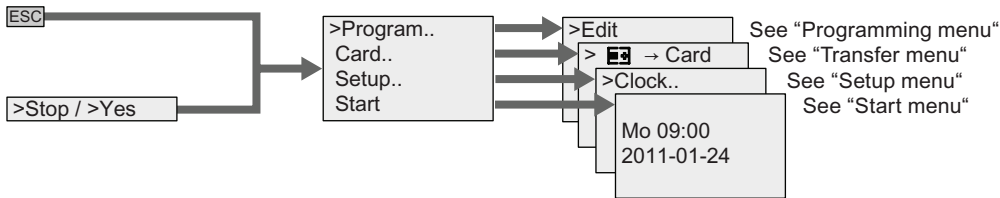

**OBA7**

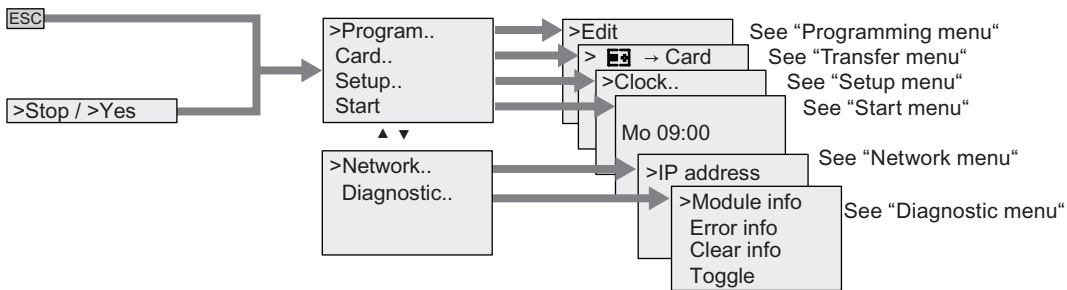

**Programming menu (ESC / > Stop → > Program)**

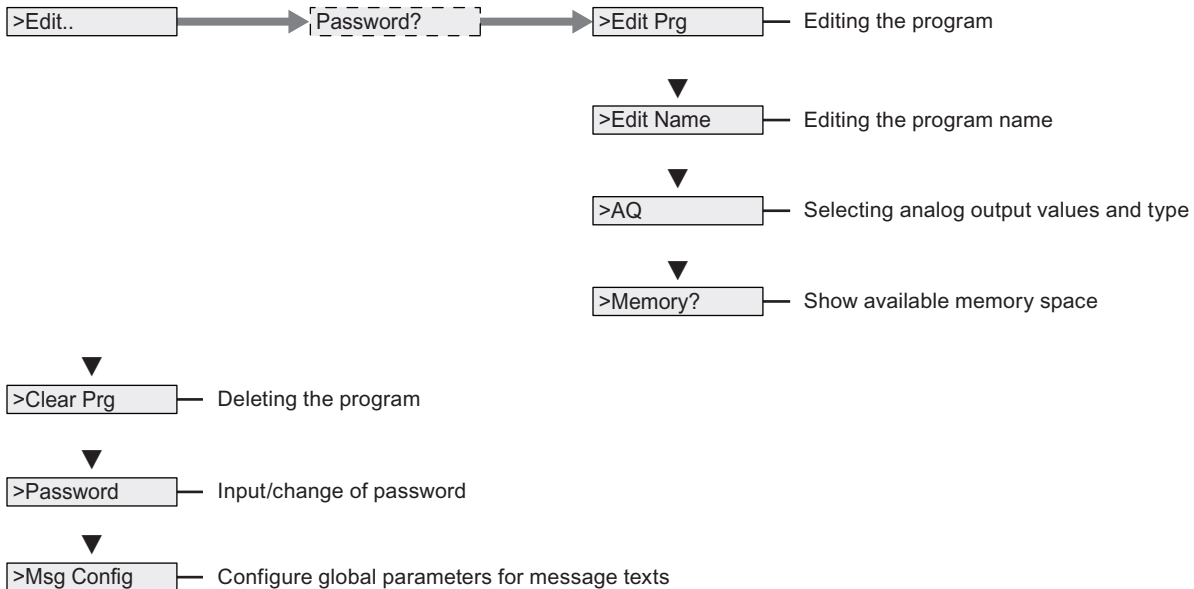



### Start Menu (RUN)

Parameter assignment menu

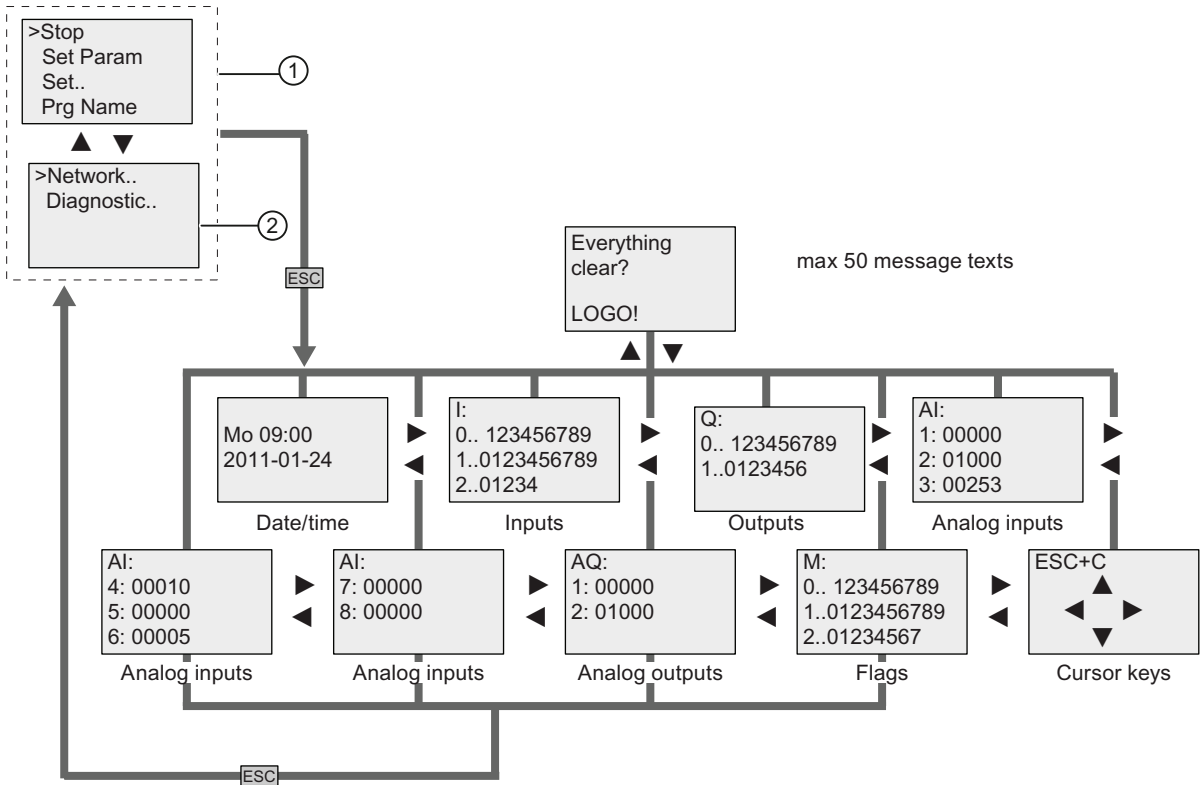

- ① LOGO! 0BA7 start screen, if configured to display by default the parameter assignment menu
- ② Two menu commands available in LOGO! 0BA7 only

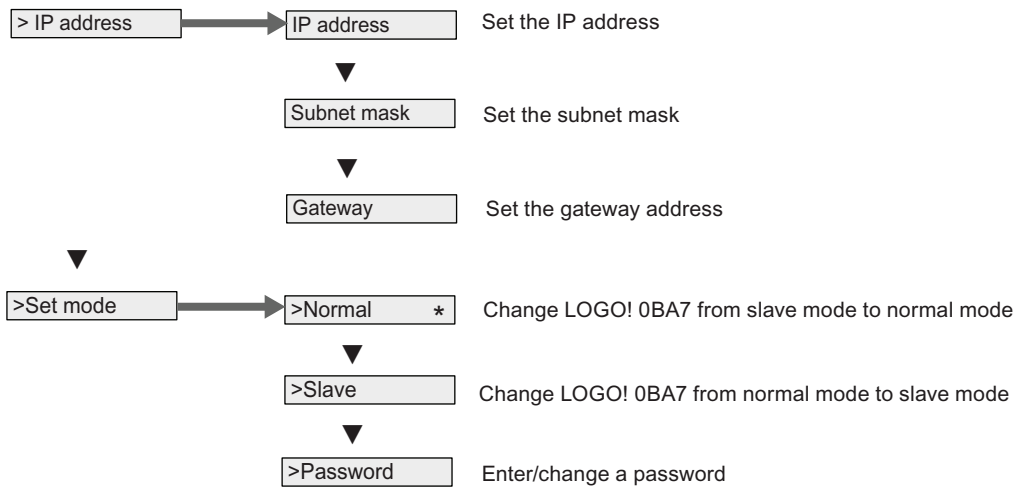
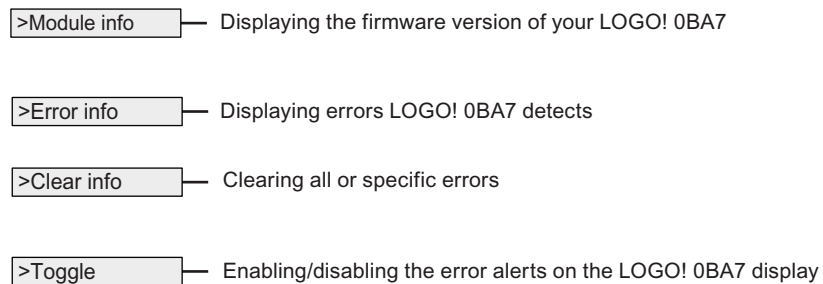

**Network menu (ESC / > Stop → > Network) (0BA7 only)****Diagnostic menu (ESC / > Stop → > Diagnostic) (0BA7 only)**

## See also

Parameters (Page 290)  
Assigning a circuit program name (Page 90)  
Selecting analog output values for RUN/STOP transition (Page 107)  
Defining the type of analog outputs (Page 109)  
Memory space and circuit program size (Page 130)  
Deleting the circuit program and password (Page 110)  
Password for circuit program protection (Page 91)  
Message texts (Page 231)  
Setting the default values for LOGO! (Page 294)  
Writing and starting the circuit program (Page 83)  
Copying data from LOGO! to the card (Page 309)  
Copying data from the card to LOGO! (Page 311)  
Security function (CopyProtect) (Page 305)  
Summertime/wintertime conversion (Page 111)  
Synchronization (Page 116)  
Setting the time of day and date (LOGO! ... C) (Page 295)  
Setting the display contrast and backlight choice (Page 296)  
Setting the number of AIs in the LOGO! Basic (Page 299)  
Setting the menu language (Page 298)  
Configuring network settings (Page 119)  
Changing LOGO! to normal/slave mode (Page 123)  
Diagnosing errors from LOGO! (Page 128)  
Setting the start screen (Page 300)

## D.2 LOGO! TD

### Menu overview

#### LOGO! TD (version ES6 or earlier)

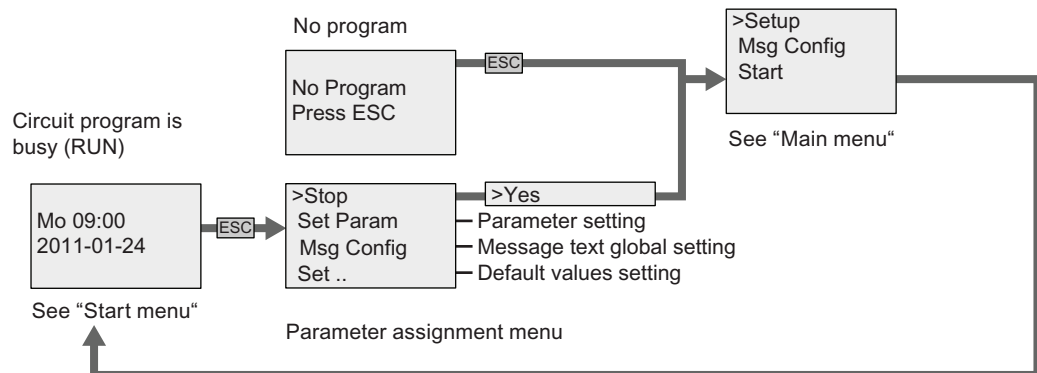

#### LOGO! TD (version ES7)

Compared to previous versions of the LOGO! TD, an ES7 LOGO! TD provides three additional main menu commands ①, ②, and ③ as shown below:

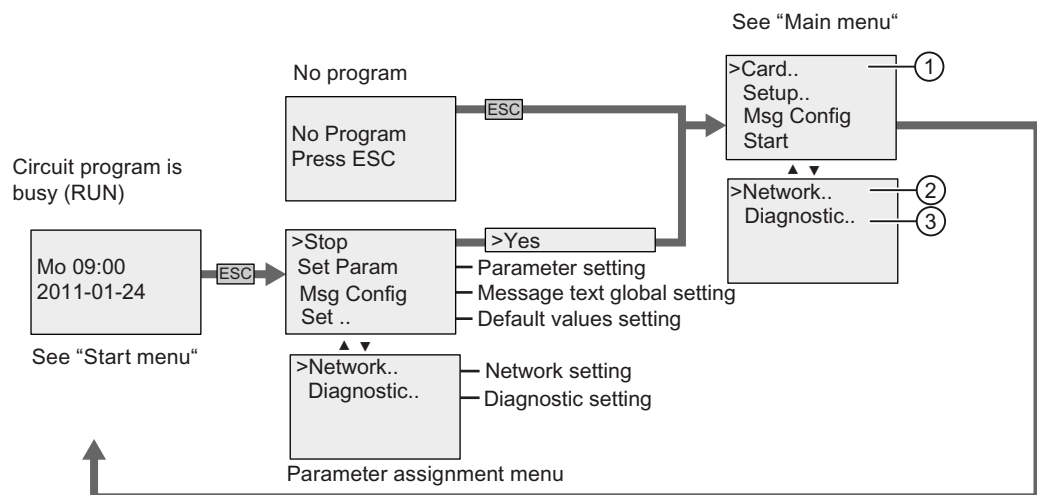

Main menu (ESC / > Stop)

LOGO! TD (version ES6 or earlier)

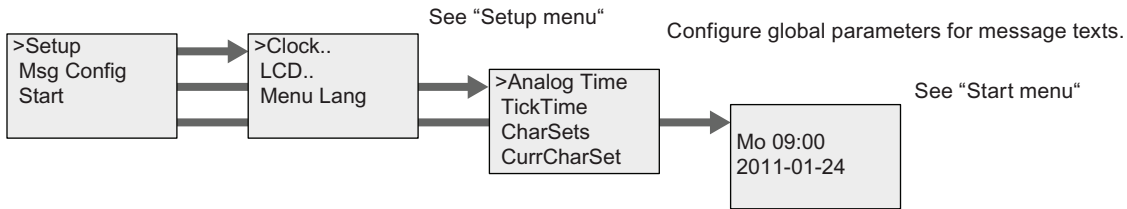

LOGO! TD (version ES7)

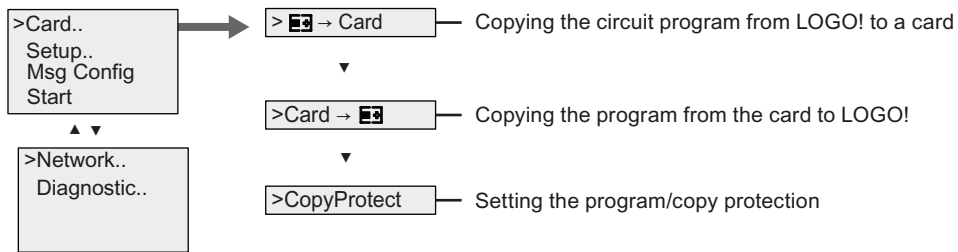

Setup menu (ESC / > Stop → >Setup)

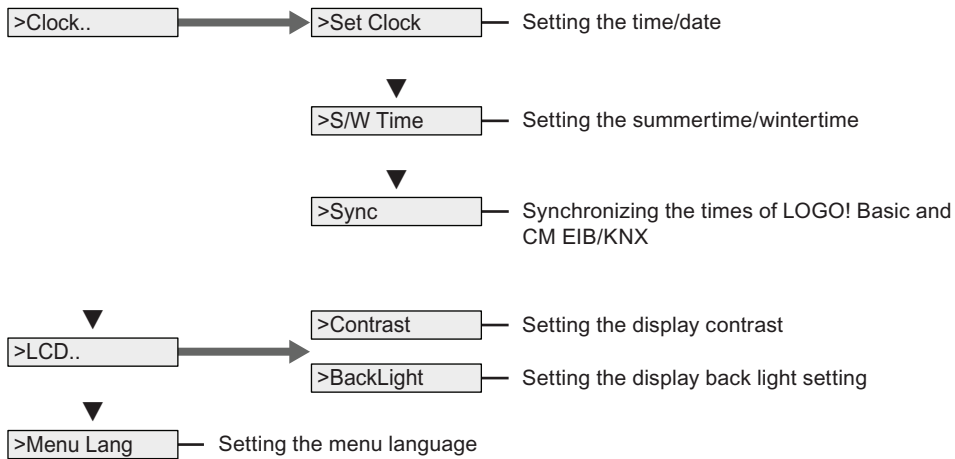

## Start menu (LOGO! Basic in RUN)

Parameter assignment menu

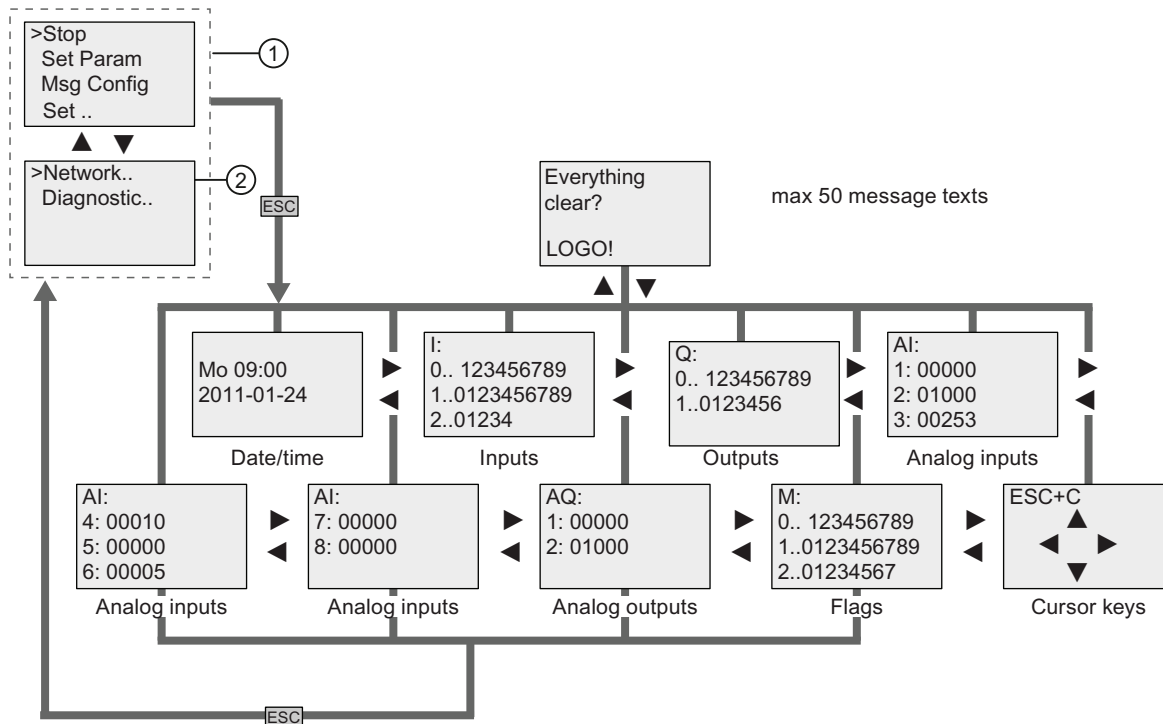

- ① ES7 LOGO! TD start screen, if configured from LOGO! 0BA7 to display by default the parameter assignment menu
- ② Two menu commands available in the ES7 version of the LOGO! TD only

### Network menu in LOGO! TD (version ES7), for LOGO! 0BA7 only

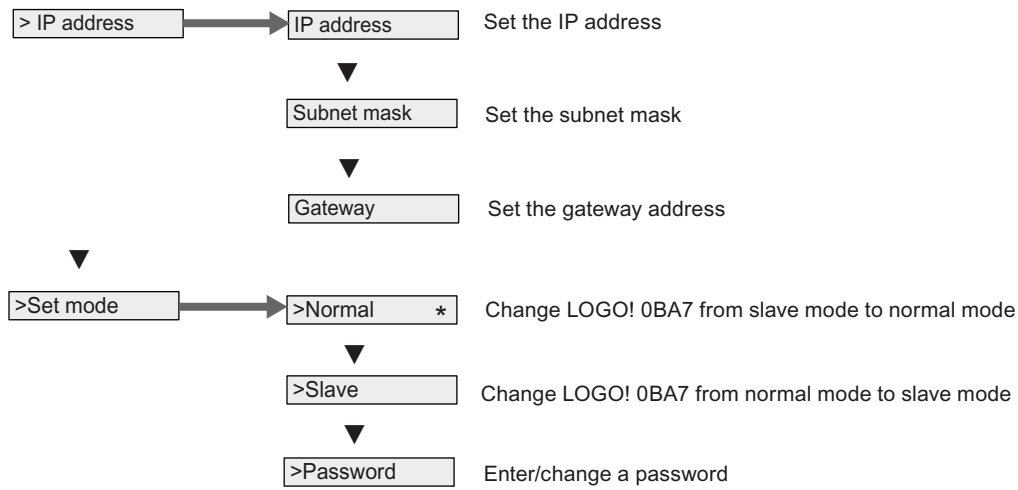

### Diagnostic menu in LOGO! TD (version ES7), for LOGO! 0BA7 only

- >Module info — Displaying the firmware version of your LOGO! 0BA7
  
- >Error info — Displaying errors LOGO! 0BA7 detects
  
- >Clear info — Clearing all or specific errors
  
- >Toggle — Enabling/disabling the error alerts on the LOGO! 0BA7 display

### See also

- Parameters (Page 290)
- Setting the default values for LOGO! (Page 294)
- Message texts (Page 231)
- Setting the time of day and date (LOGO! ... C) (Page 295)
- Summertime/wintertime conversion (Page 111)
- Synchronization (Page 116)
- Setting the display contrast and backlight choice (Page 296)
- Setting the menu language (Page 298)
- Setting the start screen (Page 300)
- Changing LOGO! to normal/slave mode (Page 123)
- Configuring network settings (Page 119)
- Diagnosing errors from LOGO! (Page 128)

# Order numbers

# E

## Modules

Variant	Designation	Order number
Basic	LOGO! 12/24 RC *	6ED1052-1MD00-0BA6
	LOGO! 12/24 RCE *	6ED1052-1MD00-0BA7
	LOGO! 24 *	6ED1052-1CC00-0BA6
	LOGO! 24C *	6ED1052-1CC01-0BA6
	LOGO! 24RC (AC/DC)	6ED1052-1HB00-0BA6
	LOGO! 230RC (AC/DC)	6ED1052-1FB00-0BA6
	LOGO! 230RCE (AC/DC)	6ED1052-1FB00-0BA7
Basic without display (pure)	LOGO! 12/24RCo *	6ED1052-2MD00-0BA6
	LOGO! 24o *	6ED1052-2CC00-0BA6
	LOGO! 24Co *	6ED1052-2CC01-0BA6
	LOGO! 24RCo (AC/DC)	6ED1052-2HB00-0BA6
	LOGO! 230RCo (AC/DC)	6ED1052-2FB00-0BA6
Digital modules	LOGO! DM8 12/24R	6ED1055-1MB00-0BA1
	LOGO! DM8 24	6ED1055-1CB00-0BA0
	LOGO! DM8 24R	6ED1055-1HB00-0BA0
	LOGO! DM8 230R	6ED1055-1FB00-0BA1
	LOGO! DM16 24	6ED1055-1CB10-0BA0
	LOGO! DM16 24R	6ED1055-1NB10-0BA0
	LOGO! DM16 230R	6ED1055-1FB10-0BA0
Analog modules	LOGO! AM2	6ED1055-1MA00-0BA0
	LOGO! AM2 PT100	6ED1055-1MD00-0BA0
	LOGO! AM2 RTD	6ED1055-1MD00-0BA1
	LOGO! AM2 AQ (0...10V, 0/4...20mA)	6ED1055-1MM00-0BA1
Communication modules	CM EIB/KNX	6BK1700-0BA00-0AA1
	CM AS Interface	3RK1400-0CE10-0AA2
Text Display module	LOGO! TD	6ED1055-4MH00-0BA0

\*: Also with analog inputs

Accessories

Accessories	Designation	Order number
Software	LOGO!Soft Comfort V7.0	6ED1058-0BA02-0YA1
	LOGO!Soft Comfort V7.0 Upgrade	6ED1058-0CA02-0YE1
Memory cards	LOGO! Memory Card	6ED1056-1DA00-0BA0
	SIMATIC Memory Card (2M) <sup>1)</sup>	6ES7954-8LB00-0AA0
	SIMATIC Memory Card (24M) <sup>1)</sup>	6ES7954-8LF00-0AA0
Battery card	LOGO! Battery card	6ED1 056-6XA00-0BA0
Combined memory/battery card	LOGO! Combined Memory/Battery Card	6ED1 056-7DA00-0BA0
Switching modules	LOGO!Contact 24 V	6ED1057-4CA00-0AA0
	LOGO!Contact 230 V	6ED1057-4EA00-0AA0
Power modules	LOGO!Power 12V/1.9A	6EP1321-1SH02
	LOGO!Power 12V/4.5A	6EP1322-1SH02
	LOGO!Power 24V/1.3A	6EP1331-1SH02
	LOGO!Power 24V/2.5A	6EP1332-1SH42
	LOGO!Power 24V/4A	6EP1332-1SH51
	LOGO!Power 5V/3A	6EP1311-1SH02
	LOGO!Power 5V/6.3A	6EP1311-1SH12
	LOGO!Power 15V/1.9A	6EP1351-1SH02
	LOGO!Power 15V/4A	6EP1352-1SH02
Others	PC cable	6ED1057-1AA00-0BA0
	USB PC cable	6ED1057-1AA01-0BA0
	Modem cable	6ED1057-1CA00-0BA0
	Manual	6ED1050-1AA00-0BE8

<sup>1)</sup> LOGO! 0BA7 only supports SD cards; however, you can also use available SIMATIC memory cards instead.



## Abbreviations

AM	Analog module
B1	Block number B1
BN	Block Number
C	LOGO! device designation: integrated clock
CM	Communication Module
Cnt	Count = Counter input
Co	Connector
Dir	Direction (of count, for example)
DM	Digital Module
E	LOGO! device designation: integrated Ethernet interface
EIB	European Installation Bus
EIS	EIB Interoperability Standard
En	Enable = switching on (e.g., clock generators)
ETS	EIB Tool Software
Fre	Input for frequency signals to be analyzed
GF	Basic Functions
Inv	Input for inverting the output signal
KNX	Konnex Association Standard for home and building electronic systems
L	Data Log
NAI	Network analog input
NAQ	Network analog output
NI	Network input
No	Cam (parameter of the timer)
NQ	Network output
o	In LOGO! designations: without display
Par	Parameter
R	Reset input
R	In LOGO! designations: Relay outputs
Ral	Reset all = Input for resetting all internal values
S	Set (latching relay, for example)
SF	Special functions
SU	Subunit
T	Time = parameter
TD	Text Display
Trg	Trigger (parameter)
UDF	User-Defined Function
0BA7 device	The latest LOGO! Basic version, described in this manual



# Index

## A

- Amplifier
  - analog, 226
- Analog
  - comparator, 218
  - values, 154
- Analog amplifier, 226
- Analog differential trigger, 216
- Analog filter, 271
- Analog module, 14
- Analog multiplexer, 248
- Analog ramp, 251
- Analog threshold trigger, 213
- Analog watchdog, 223
- AND, 143
- AS interface bus
  - communication failure, 68
  - communication states, 68
- AS-Interface, 15
- Astronomical clock, 195
- Asynchronous pulse generator, 175
- Average value, 276

## B

- Backlight flags, 139
- Backlight lifetime
  - LOGO! TD, 347
- Basic functions, 137, 142
  - AND, 143
  - AND, with edge, 144
  - NAND, 145
  - NAND, with edge, 146
  - NOT, 149
  - OR, 147
  - XOR, 149
- Basics on special functions, 150
- blank outputs, 138
- BN, 137

## C

- Cap, 40

- Card See Program module (card), 303
- CE label, 27
- Ch by Ch ticking, 237
- Character set flag, 140
- Character sets, 231
- Chinese character set, 232
- circuit program, 130
- Circuit programs
  - archiving, 303
  - reproduce, 303
  - send by mail, 303
- CM See Communications module, 15
- Co, 15
- Combined memory/battery card, 303
- Communication module
  - AS-Interface, 15
  - EIB/KNX, 15
- Communication modules, 15
- Compatibility
  - Expansion modules, 38
- Connector, 40
- Connectors, 137
  - hi, 72
  - lo, 72
  - open, 140
  - outputs, 72
  - unused, 71, 77
  - x, 71, 72, 77, 151
- Conversion
  - Summertime and wintertime, 111
- Counters
  - Operating hours, 205
  - Threshold trigger, 210
  - Up/down, 201
- cULus, 27
- Cursor keys, 140, 241

## D

- Data Log, 285
- Days of the week, 187
- Demo versions, 314
- Detection of mathematic instruction error
  - Analog amplifier, 268
- Digital module, 14

DIN rail, 39  
Display lifetime  
    LOGO! TD, 347  
Display modules, 14  
Divide by 0 error, 268  
DM8... See Digital module, 14

## E

Edge evaluation, 144, 146  
EIB bus  
    communication failure, 68  
    communication states, 68  
EIB/KNX, 15  
Errors, mathematic instruction, 268  
Ethernet interface, 62  
exclusive OR, 149  
Expansion modules, 38  
    Analog, 14  
    digital, 14  
    operating state, 67

## F

Flag blocks, 139  
FM, 27  
Frequency trigger, 210  
Function keys, 15

## G

Gain, 154  
GB-2312, 231  
GF, 137, 142

## H

high-speed counting, 51  
Hours counter, 205  
    Reading the MN and OT values, 207  
Hysteresis, 222

## I

inputs  
    High-speed inputs, 51  
Inputs, 138  
    Analog inputs, 51, 138  
    Cursor keys, 140  
    Digital Inputs, 138

    inverting, 142, 156

## Instructions

    Basic functions (GF), 137  
    Connectors (Co), 137  
    GF, 142  
    SF, 156  
    Special Functions (SF), 137  
Interlock, 42  
Internet address, 7  
Inverter, 149  
ISO8859-1, 231  
ISO8859-16, 231  
ISO8859-5, 231  
ISO8859-9, 231

## L

Latching relay, 228  
LCD lifetime  
    LOGO! TD, 347  
LED, 352  
Levels, 140  
Ln by Ln ticking, 237  
Logical inputs, 150  
LOGO! 0BA7 network setup, 33  
LOGO! TD, 347  
    Backlight lifetime, 347  
    Display lifetime, 347  
    function keys, 15  
    power-up screen, 15

## M

Math error  
    analog, 268  
Mathematic instruction, 265  
Mathematic instruction error detection, 268  
Max/Min, 273  
Memory  
    limitation, 130  
Memory card, 303  
    Card → LOGO, 312  
    CopyProtect, 306  
    LOGO → Card, 309  
Memory/battery card, 303  
Message text charset flag, 140  
Message texts, 231  
    character set, 231  
Message ticking, 236  
Mode  
    PC-LOGO, 315

Modems, 6  
Multiple function switch, 182

## N

NAND, 145  
Negation, 149  
  of an input, 142  
  of an SF input, 156  
Network analog inputs, 141  
Network analog outputs, 141  
Network communications, 4  
Network digital inputs, 141  
Network digital outputs, 141  
Network inputs/outputs, 141  
normal, 123  
NOT, 149

## O

Offset, 154  
Off-time, 187  
On-/Off- delay, 166  
On-delay, 160  
On-delay, retentive, 168  
On-time, 187  
Open connectors, 140  
OR, 147  
Outputs, 138  
  Analog outputs, 139  
  blank, 138  
  Digital outputs, 138  
Overflow error, 268

## P

Parameter  
  Inputs, 151  
  Set Param, 289  
  setting, 287  
  T, 151  
Parameter assignment screen form, 186, 236  
Parameter protection, 153  
PC-LOGO, 315  
PI controller, 256  
Program cycle, 349  
Program memory, 130  
Program name  
  change, 91  
  character set, 90  
  read, 289

Programming menu  
  AQ in Stop, 107  
  AQ type, 109  
  Clear Prg, 110  
  Edit Name, 90  
  Edit Prg, 84  
Pulse  
  Pause, 173  
  width, 173  
Pulse generator  
  Asynchronous, 175  
Pulse output, 170  
Pulse relay, 229  
Pulse Width Modulator (PWM), 261  
PWM, 261

## R

Random generator, 177  
Real-time clock, 22  
Relay outputs, 337  
  service life, 337  
  switching capacity, 337  
Removal, 42  
Retentive on-delay, 168  
Retentivity, 153

## S

SD card support, 4  
Sensor connections, 52  
Set clock, 295  
Setting the date, 294  
Setup  
  with different voltage classes, 36  
SF, 156  
Shift register, 245  
Shift register bits, 140  
Shift-JIS, 231  
Signal status transitions, 50  
Simulation, 313  
slave, 123  
Softkey, 243  
Software, 313  
Special functions, 137, 156  
  Analog amplifier, 226  
  Analog comparator, 218  
  Analog differential trigger, 216  
  Analog filter, 271  
  Analog multiplexer, 248  
  Analog ramp, 251

- Analog threshold trigger, 213
- Analog watchdog, 223
- Astronomical clock, 195
- Asynchronous pulse generator, 175
- Average value, 276
- Basics, 150
- Edge-triggered wiping relay, 172
- Hours counter, 205
- Latching relay, 228
- Mathematic instruction, 265
- Mathematic instruction error detection, 268
- Max/Min, 273
- Message texts, 231
- Multiple function switch, 182
- Off-delay, 164
- On-/Off- delay, 166
- On-delay, 160
- PI controller, 256
- Pulse output, 170
- Pulse relay, 229
- Pulse Width Modulator (PWM), 261
- Random generator, 177
- Relays, 170, 172, 228, 229
- Retentive on-delay, 168
- Softkey, 243
- Stairway lighting switch, 179
- Stopwatch, 198
- Threshold trigger, 210
- Triggers, 213, 216
- Up-down counter, 201
- Weekly timer, 185
- Wiping relay, 170
- Yearly timer, 190
- Stairway lighting switch, 179
- Start, 97
- Startup flag, 139
- Stop, 107
- Stopwatch, 198
- Subunits, 39
- Summertime, 111
- Summertime/wintertime conversion, 294
  - Clock, 111
  - S/W Time, 112
- Switch
  - Multiple function, 182
  - Stairway lighting, 179
- Switched current
  - maximum, 56
- Synchronization, 294
  - Clock, 116
  - Sync, 116

## T

- Text Display (TD), 15
- Threshold trigger, 210
- Ticker, 236
- Time response, 151
- Timebase, 151, 161
- Timer
  - accuracy, 152
- Timers
  - Astronomical clock, 195
  - Asynchronous pulse generator, 175
  - Edge-triggered wiping relay, 172
  - Multiple function switch, 182
  - Off-delay, 164
  - On-/Off- delay, 166
  - On-delay, 160
  - Random generator, 177
  - Retentive on-delay, 168
  - Stairway lighting switch, 179
  - Stopwatch, 198
  - Weekly, 185
  - Wiping relay (pulse output), 170
  - Yearly, 190
- Trigger
  - Analog differential, 216
  - Analog threshold, 213

## U

- Unused connectors, 71, 77
- Up/down counter, 201
- User-Defined Function (UDF), 279

## V

- Voltage levels, 140
- Voltage supply
  - Circuit protection, 47

## W

- Weekly timer, 185
  - Examples, 188
  - setting, 187
- Wintertime, 111
- Wiping relay
  - edge triggered, 172
- Wire ferrules, 46
  - without display
    - PC-LOGO mode, 315

**X**

XE \\* MERGEFORMAT, 107  
XOR, 149

**Y**

Yearly timer, 190

**Z**

Zero division error, 268  
Zero offset, 154

