

B2900A Series Precision Source/Measure Unit

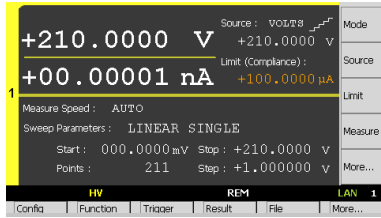

Innovative SMU Provides Superior Performance and Rapid Measurement Results



Single view

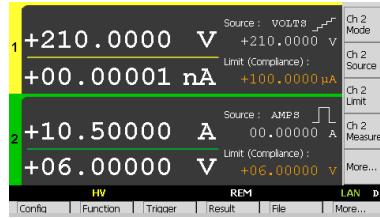

Dual View

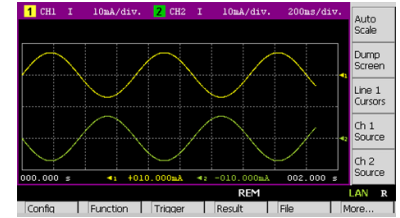

Roll View

The Keysight B2900A Series of Precision Source/Measure Units are compact and cost-effective bench-top Source/Measure Units (SMUs) with the capability to source and measure both voltage and current. These capabilities make the B2900A Series ideal for a wide variety of IV (current versus voltage) measurement tasks that require both high resolution and accuracy.

The B2900A Series provide best-in-class performance for a modest price. They have broad voltage (± 210 V) and current (± 3 A DC and ± 10.5 A pulsed) sourcing capability, excellent precision (minimum 10 fA/100 nV sourcing and measuring resolution) and possess a superior color LCD graphical user interface (GUI). In addition, several task-based viewing modes dramatically improve productivity for test, debug and characterization.

The B2900A Series offers unmatched measurement throughput and supports conventional SMU SCPI commands for easy test code migration. These features improve efficiency and lower the cost of ownership when integrating the SMUs into systems for production test.

The B2900A Series consists of four models, the B2901A, B2902A, B2911A and B2912A, differentiated through their available features (number of digits displayed, measurement resolution, minimum timing interval, supported viewing modes, etc.) and by the number of SMU channels (one or two) they contain. This makes it easy to select the exact price/performance point you require to meet your testing needs.

Feature	Benefit
Integrated 4-quadrant sourcing and measuring capabilities	Easily and accurately measure current and voltage using a single instrument without the need to manually change any connections
Measurement range: ± 210 V, ± 3 A (DC), ± 10.5 A (pulsed)	A single SMU product covers both high voltage and high current measurement needs, allowing for more standardization and simplifying inventory and support concerns.
Source and measurement resolution down to 10 fA and 100 nV	Can make low-level measurements using a low-cost bench-top SMU that were previously only possible using a more expensive semiconductor device analyzer.
User-friendly front panel GUI with 4.3 inch color LCD display supports both graphical and numerical view modes	Can quickly and easily perform measurements and display data on the front panel, thereby greatly speeding up interactive test, characterization and debug operations.
10 microsecond digitizing capability	Can capture low frequency phenomena in addition to DC characteristics
PC-based control software	Can make measurements remotely from a PC without the need to program.
Supports both conventional and default SCPI commands	Conventional SCPI commands provide some compatibility with older SMU code (such as Keithley 2400 series) to minimize code conversion work. Default SCPI commands support advanced B2900A Series features
Small form factor with USB2.0, LAN, GPIB and digital I/O interfaces	Easy integration into rack and stack systems.

The Best SMU Solution for a Broad Range of IV Measurements



Keysight B2900A Series Precision Source/Measure Unit

SMUs are popular and widespread instruments for performing IV measurements in many different fields and applications due to their integrated voltage and current sourcing and measurement capabilities. The Keysight B2900A Series provides superior performance and usability at a very reasonable price. In addition, the Keysight B2900A Series supports many functions to speed up production test and increase throughput. The versatile measurement capabilities of the B2900A Series SMUs make them an ideal choice for a variety of IV measurements such as semiconductor test, active/passive component test and general electronic device and material characterization.

The B2900A Series has a broad application range that spans uses from R&D and education to industrial development, production test and automated manufacturing. Moreover, they work equally well as either standalone or system components.

Testing semiconductors, discrete and passive components

Diodes, laser diodes, LEDs
Photodetectors, sensors
Field effect transistors (FETs), bipolar junction transistors (BJTs)
ICs (analog ICs, RFICs, MMICs, etc)
Resistor, varistor, thermistors, switches

Testing precision electronics and green energy devices

Photovoltaic cells
Power transistors, power devices
Battery
Automotive
Medical instruments
Power and DC bias source for circuit test

Research and education

New material investigations
Nano devices characterization (e.g. CNT)
Giant magnetic resistance (GMR)
Organic devices
Any precise voltage/current source and measurement

Application literature is available on the Keysight web site. For more information please visit

www.keysight.com/find/precisionSMU

Integrated Source and Measurement Capabilities Simplify Difficult IV Measurement Tasks

The Keysight B2900A Series reduces measurement complexity

Performing IV measurements with conventional instruments such as voltage/current sources, arbitrary waveform generators (AWGs), switches, and voltage/current meters is complicated and confusing. It requires deep technical knowledge of both the measurement technique and the instrumentation to perform an accurate measurement.

The Keysight B2900A SMU integrates many different source and measurement capabilities into one compact form factor. It can operate as a seamless 4-quadrant precision voltage/current source, an electrical load, an accurate

voltage/current meter, a pulse generator and an AWG. Its versatile all-in-one integrated source and measurement capabilities allow it to perform a wide variety of measurements from DC to low frequency AC without the need to change connections or use additional equipment. Moreover, the availability of 2-channel models supports the testing of devices with up to three terminals (as long as one terminal can be tied to the circuit common).

If you wish to learn more about the advantages of using SMUs to make IV measurements, then please refer to the section at the back of this brochure entitled "Overview: Why use an SMU?"

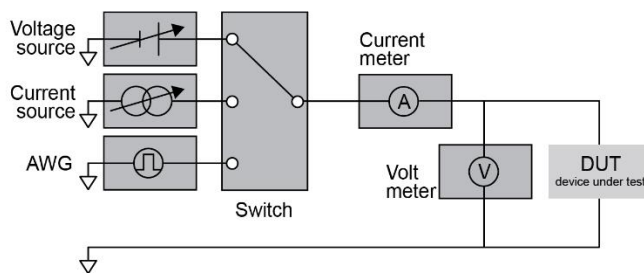

Rack & stack solution:
Multiple instruments connected together with no easy means to coordinate them.

Same measurement using an SMU



SMU solution:
Integrated 4-quadrant voltage and current sourcing and measurement (including AWG function).

Wide Voltage and Current Coverage for Testing a Variety of Devices

Test up to 210 V and 3 A (DC) or 10.5 A (pulsed) with a single instrument

The B2900A SMUs can source and measure voltages of ± 210 V and currents of ± 3 A (DC) or ± 10.5 A (pulsed). This versatility allows you to standardize on a single SMU model and minimize support costs. These capabilities are present on both single and dual channel versions, since on the 2-channel versions both channels can be operated completely independently.

Integrated sweep and arbitrary waveform measurement functionality

The B2900A Series has capabilities that allow it to perform more than just simple DC and pulsed measurements. The B2900A SMUs have a built-in sweep capability that supports all of the standard sweep parameters such as linear and logarithmic modes, single and double sweep functions and constant and pulsed sweep operation. The B2900A GUI fully supports the sweep measurement

function, thereby allowing sweep measurements to be made and displayed quickly from the instrument front panel. Of course, the user can also make the same sweep measurements just as efficiently on the B2900A SMUs under remote control using SCPI commands. This integrated sweep measurement capability improves efficiency and reduces measurement setup time.

In addition to its resident sweep functionality, the B2900A Series also supports arbitrary waveform generation (AWG) and list sweep capabilities. The AWG and list sweep functions allow you to create waveforms with up to 100,000 steps for maximum flexibility, and enable you to specify a waveform of arbitrary shape using familiar spreadsheet compatible data-entry formats. The AWG and list sweep features are especially useful when characterizing devices where the response varies greatly depending upon the applied voltage or current, since they give you the flexibility to “zoom in” on areas of interest.

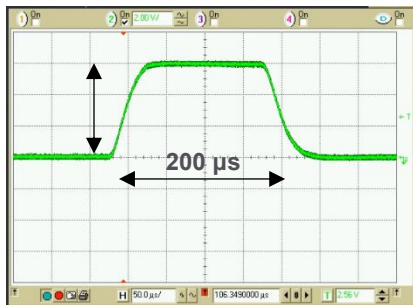

You can create current pulses of up to 10.5 amps, which helps to minimize device self-heating effects.

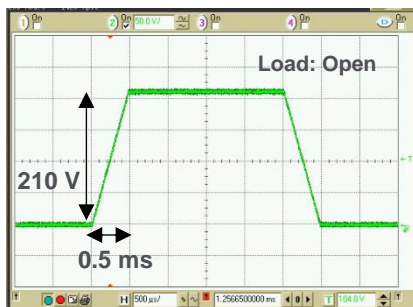

You can ramp up to a voltage of 200 V in 0.5 millisecond, which is useful for evaluating high-power components.

Built-in functions provide flexible waveform generation capabilities

Constant DC Pulse

Linear sweep Pulsed linear sweep Logarithmic sweep

Custom wave forms (list sweep)

Unmatched Bench-top SMU Measurement Performance

Source and measurement resolution down to 10 fA and 100 nV

The Keysight B2900A Series consists of four models primarily differentiated by number of channels (one or two) and measurement and sourcing resolution. The B2901A (single channel) and B2902A (dual channel) versions possess 100 fA and 100 nV measurement resolution and 1 pA and 1 μ V sourcing resolution. The B2911A (single channel) and B2912A (dual channel) precision versions possess 10 fA and 100 nV of resolution for both measurement and sourcing. All members of the Keysight B2900A Series support popular banana jack style inputs for cost-effective and flexible connectivity; for low-current measurements below 1 nA, banana jack to triaxial adapters are available.

Capture transient phenomena effortlessly

The Keysight B2900A Series supports a high speed sampling measurement function that permits the capture and display of low frequency transient phenomena. The Keysight B2901A and B2902A support a 20 μ s (50,000 points/s) sampling rate and the Keysight B2911A and B2912A support a 10 μ s (100,000 points/s) sampling rate. Of course, the maximum achievable sampling rate depends on many factors including signal level, ambient noise and desired resolution.

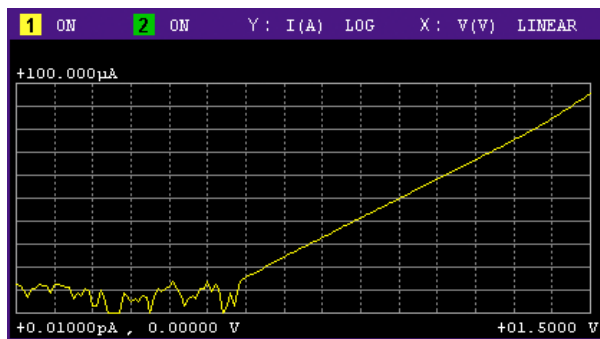

You can make and display accurate low-current measurements directly on the B2900A front panel.

4-wire measurement capability permits accurate low resistance measurement

When measuring small resistances the innate cable resistance can create serious measurement error. To solve this, the Keysight B2900A Series supports a 4-wire (also known as a remote sense or Kelvin connection) measurement function. In the 4-wire scheme two of the connectors force current and the other two connectors measure voltage. Since the connectors measuring voltage do not have any current flowing through them, they can accurately sense the actual voltage at the DUT.

Measure large capacitive loads without oscillation

Large capacitive loads can sometimes cause SMUs to oscillate. To mitigate this, the B2900A Series supports a high capacitance measurement mode. The high capacitance mode enables the measurement of large capacitive loads without having to worry about SMU oscillation.

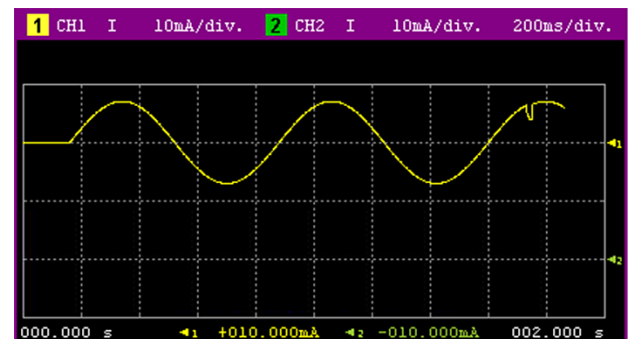

Roll view mode allows you to capture low-frequency transient phenomena.

Ultra Fast Throughput Lowers Cost-of-test

Best-in-class measurement throughput

Although an excellent R&D tool, the Keysight B2900A Series is also well-suited for production test. It can achieve excellent accuracy and repeatability at even short integration times. The B2900A Series possesses the fastest measurement speed of any SMU in its class.

Program memory and trace buffer features improve throughput

To reduce bus communication time, the B2900A Series supports a program memory feature that allows long strings of SCPI commands to be stored on the instrument. These code sequences can be executed by sending a single command across the communication bus, greatly improving throughput for frequently executed command strings. In addition, the B2900A Series supports a trace buffer that can store up to 100,000 data points. This allows the results from multiple measurements to be downloaded at once, thereby reducing data transfer time and also improving overall throughput.

SCPI commands provide compatibility and versatility

Standard Commands for Programmable Instruments (SCPI) are a popular and easy-to-understand instrument control protocol. The Keysight B2900A Series supports two SCPI command sets, conventional and default, to provide both code compatibility and flexibility. The conventional command set has a large number of its commands compatible with those of older SMUs (such as the Keithley 2400) to minimize code conversion work. The default command set supports advanced Keysight B2900A Series features and they should be used to fully utilize its performance and capabilities.

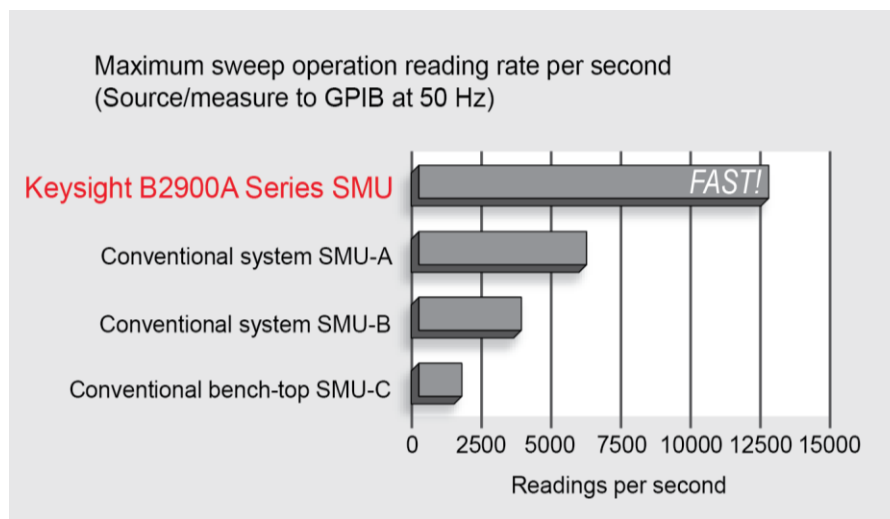

Overview: Why Use an SMU?

Resource integration reduces measurement error

An SMU is an instrument that combines the capabilities of a current source, a voltage source, a current meter and a voltage meter (along with the capability to switch easily between these various functions). Because the source and measurement circuitry is closely integrated, the user can achieve far better measurement performance with less measurement error than would be possible by using various independent instruments to make the same measurement.

Feedback mechanism stabilizes voltage and current sourcing

Since SMUs have the ability to very accurately measure their own current and voltage output, they have many advantages over conventional power supplies. All SMUs have internal feedback loops that provide instantaneous feedback to the sourcing circuitry, which in-turn allows the SMU output to remain accurate and stable even if the load conditions change unexpectedly.

Limit (compliance) feature prevents device damage

SMUs also possess a voltage and current limit (compliance) feature that allows the user to set limits and to protect devices from damage caused by excessive voltage or current. Although the SMU normally continues to function when it reaches the user-specified limit value, it can also be set to shutdown just like the over current protection (OCP) and over voltage protection (OVP) functions do on a power supply.

Accurate timing control of source and measurement resources

The integration of the source and measurement resources in an SMU allows much tighter synchronization than would be possible with separate instruments. Moreover, the B2900A Series provides very flexible triggering options that allow the measurements points to be defined independently from the sourced current or voltage waveform. On two channel units you can operate both channels in synchronization or independently, and under remote control you can trigger multiple units in unison using a group trigger signal.

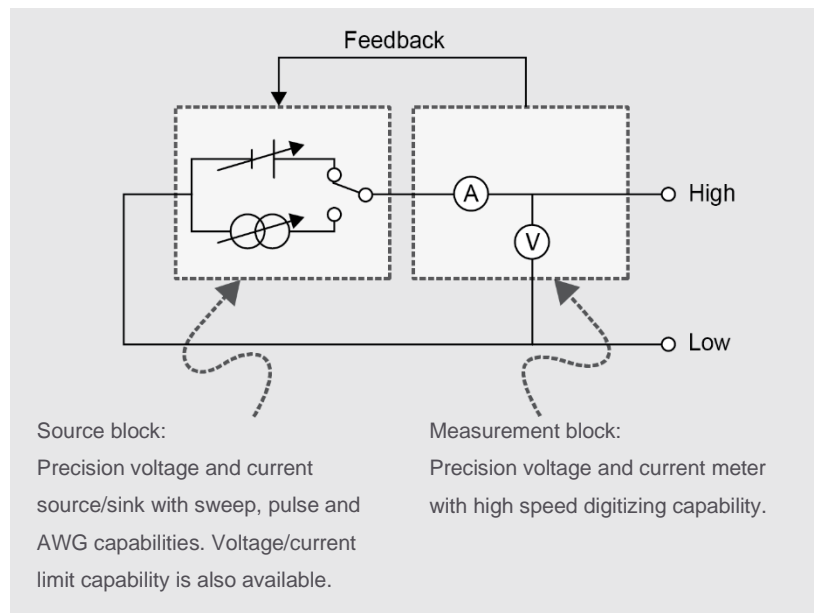

Simplified block diagram of the Keysight B2900A Series

Innovative GUI and 4.3" Color LCD Display Facilitate Fast Bench-top Test, Debug and Characterization

The B2900A's front panel has many features that make interactive use fast and friendly. These include a 4.3" color LCD display, a USB2.0 memory I/O port, an assist key, an alphanumeric keypad and a rotary knob. The 4.3" color LCD display supports both graphical and numerical view modes, and enables test setup and check test results quickly. The

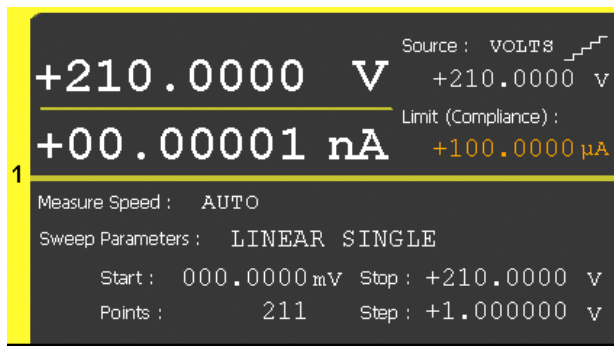

Single view:

Single view provides basic and advanced settings and display capabilities for the selected channel from the front panel of the instrument. No additional controller or software is required.

USB2.0 memory port supports easy data storing and porting. The Innovative graphical user interfaces, such as single view, dual view, graph view, roll view and zoom, improves usability and productivity of bench-top tests, debug and characterizations dramatically.



Dual view:

Dual view provides the basic settings and display capabilities for both channels 1 and 2. Up to 6. digits can be displayed in dual view mode. This mode is available only for the B2902A/B2912A.

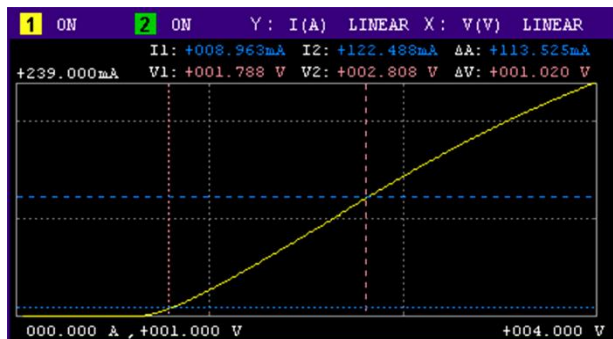

Graph view:

Graph View displays measurement results on XY graphs (such as I-V and I-t/V-t curves) on up to 2 channels. This is useful for quick evaluation of device characteristics, especially those obtained from sweep measurements.

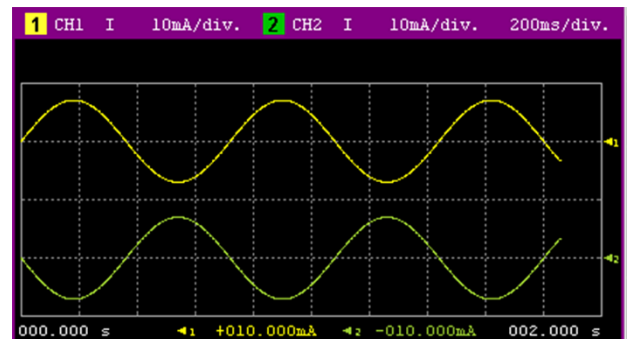

Roll view:

Roll view draws I-t or V-t curves similar to the curves drawn by a strip chart recorder. Up to 1000 acquired data points can be displayed and updated while the measurement is still in progress. Roll view's continuous measurement capability is especially useful for monitoring low frequency phenomena. Roll view is available only for the B2911A/B2912A.

Multiple Remote Control Choices Optimize Performance for Different Applications

The Keysight B2900A Series of SMUs offers multiple options for instrument remote control at little or no cost. Four solutions are available: BenchVue, B2900A Graphical Web Interface, B2900A Quick IV Measurement Software, and EasyEXPERT group+. These multiple software control options allow you to choose the solution that best fits your particular application

BenchVue

BenchVue allows you to control the B2900A SMUs as voltage/current sources from a PC without the need to do any programming. In addition, because BenchVue supports a wide variety of Keysight instruments (oscilloscopes, meters, etc.) it is a good choice when you need to integrate together many different types of instruments on a benchtop.



Graphical Web Interface

The Keysight B2900A has a built-in LXI compliant web server that allows any Java enabled web browser (such as Internet Explorer) to control it over the LAN. The graphical web interface supports all of the basic measurement functions such as spot measurements, sweep measurements and pulsed source measurements. Since no special software is required this feature is convenient for making quick measurements on the fly.

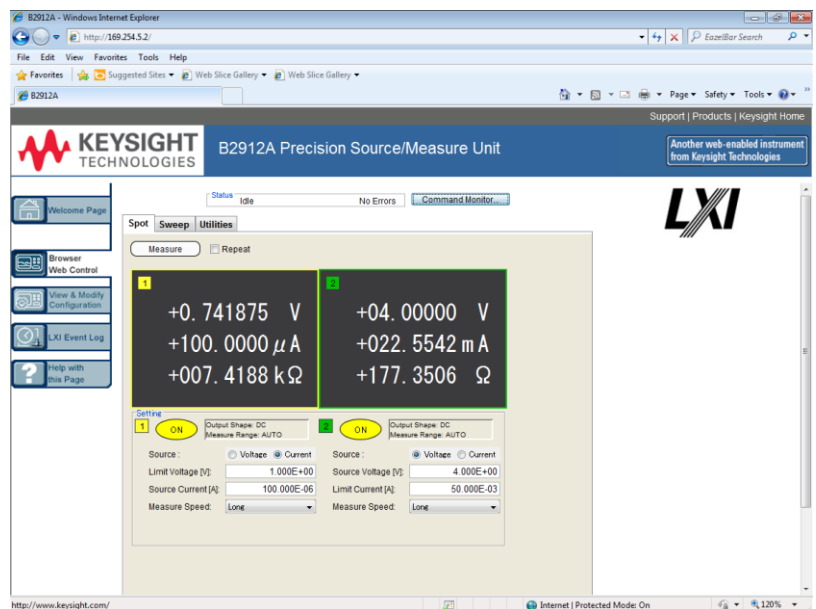

Quick I/V Measurement Software

Keysight B2900A Quick I/V Measurement Software permits easy measurement setup and execution on a Windows-based PC. It has a user-friendly GUI that can be used with all of the B2900A's interfaces (LAN, USB and GPIB). It can control up to four SMU channels in any configuration of single and dual channel units.

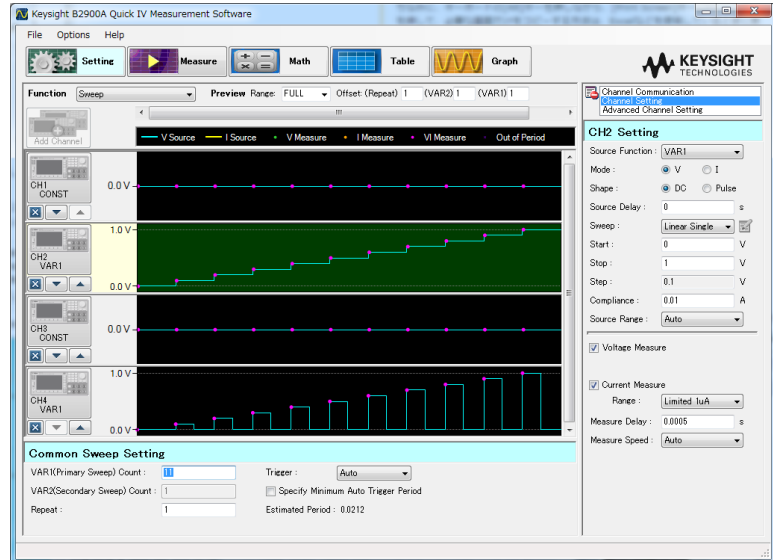

EasyEXPERTgroup+

Keysight EasyEXPERT group+ provides a powerful IV parametric characterization solution for a wide range of devices and materials. It has an intuitive mouse and keyboard driven graphical user interface that simplifies common characterization tasks such as test setup and execution, data analysis, data management/protection, etc. Moreover, since it can support up to eight SMU channels (four 2-channel SMU units) EasyEXPERT group+ makes it easy to characterize multi-terminal devices.

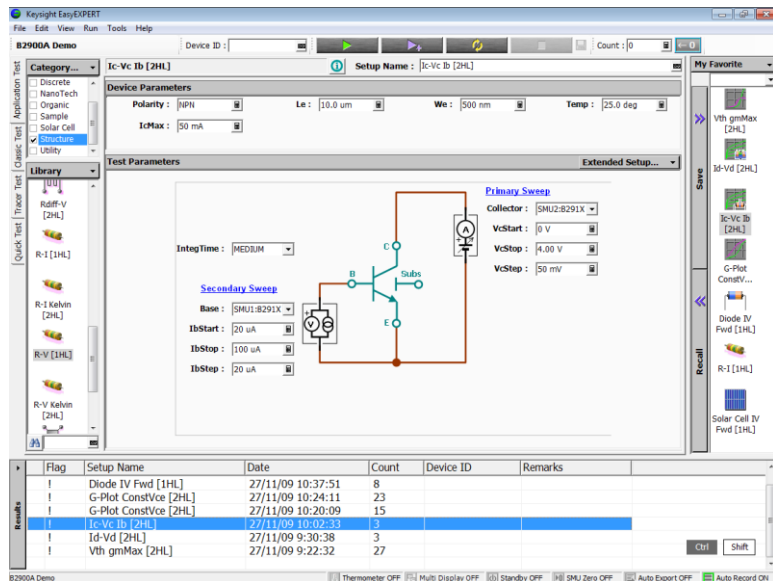

Available Accessories Facilitate Special Test Needs

Easy banana jack connectivity with various accessories

The Keysight B2900A uses convenient and low-cost banana jack terminals, which support a variety of cables, adaptors and accessories.

Banana to triaxial adaptor for low current measurement

Since banana jacks cannot support low current measurement (i.e. measurements of 1 nA and below), a banana jack to triaxial adapter is available to permit the use of high-performance triaxial cables. This makes it easy to connect to both triaxial-based test fixtures and wafer probers. Of course, both 2-wire and 4-wire triaxial adapters are available

Test fixtures for testing packaged devices

The Keysight N1295A Device/Component Test Fixture provides a low-cost solution to quickly and easily test packaged devices and components. It has four triaxial inputs and supports voltage and current measurements of up to 42 V and 1 A.

For more advanced packaged testing needs, the Keysight 16442B test fixture provides more capabilities. It offers support for higher pin count devices, more flexible connectivity and an interlock feature for safely applying voltages greater than 42 V. Keysight can supply adapters to use the 16442B interlock with the B2900A's digital output.

Banana jack to triaxial adapters are available in both 2-wire and 4-wire versions.



Using the available accessories and furnished software you can create a low-cost PC-based component testing solution.

The Keysight N1295A Device/Component Test Fixture provides a low-cost solution to quickly and easily test packaged devices and components.

Specifications

Specification conditions

Temperature	23 °C ± 5 °C
Humidity	30% to 80% RH
After 60 minutes warm-up	Ambient temperature change less than ± 3 °C after self-calibration execution
Calibration period	1 year
Measurement speed	1 PLC (power line cycle)

Maximum voltage and current

	Max voltage	Max current
DC or pulsed ¹	210 V	0.105 A
	21 V	1.515 A ²
	6 V	3.03 A ²
Pulsed only ¹	200 V	1.515 A
	6 V	10.5 A

- See "Maximum pulse width and duty cycle" in Pulse Source Supplemental Characteristics for applicable maximum voltage and current.
- Max current limitation: For 21 V/1.515 A and 6 V/3.03 A ranges, total max current is limited by the table below for using 2 channels. Max current is not limited for using 1 channel only.

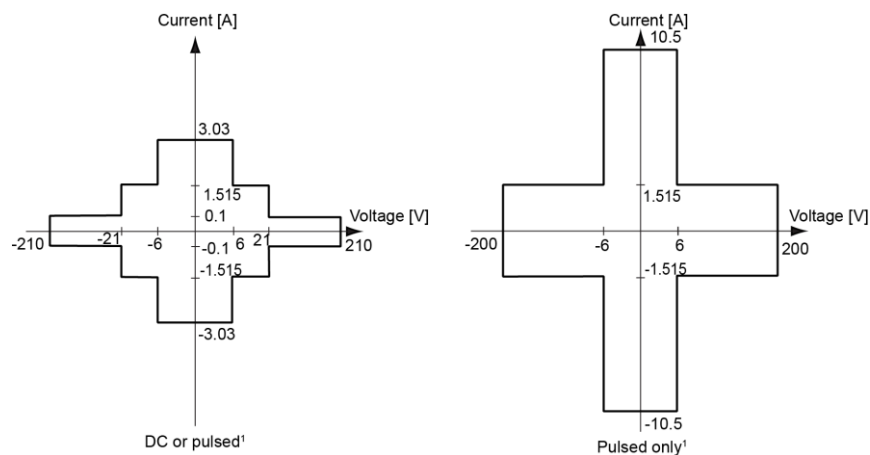

Maximum current limitation

Ch1 voltage	Ch2 voltage	Max total current limitation of Ch1 and Ch2
±(0 V < V ≤ 6 V)	±(0 V < V ≤ 6 V)	Ch1 current + Ch2 current ≤ 4 A
±(0 V < V ≤ 6 V)	±(6 V < V ≤ 21 V)	Ch1 current + Ch2 current x 1.6 ≤ 4 A
±(6 V < V ≤ 21 V)	±(0 V < V ≤ 6 V)	Ch1 current + Ch2 current x 0.625 ≤ 2.5 A
±(6 V < V ≤ 21 V)	±(6 V < V ≤ 21 V)	Ch1 current + Ch2 current ≤ 2.5 A

Voltage source specifications

Range	Programming resolution		Accuracy (% reading + offset)	Noise (peak to peak) 0.1 Hz to 10 Hz ¹	Max voltage (over range)
	B2901A/B2902A	B2911A/B2912A			
±200 mV	1 µV	100 nV	±(0.015 % + 225 µV)	≤ 10 µV	±210 mV
±2 V	10 µV	1 µV	±(0.02 % + 350 µV)	≤ 20 µV	±2.1 V
±20 V	100 µV	10 µV	±(0.015 % + 5 mV)	≤ 200 µV	±21 V
±200 V	1 mV	100 µV	±(0.015 % + 50 mV)	≤ 2 mV	±210 V

1. Supplemental characteristics

Current source specifications

Range	Programming resolution		Accuracy (% reading + offset)	Noise (peak to peak) 0.1 Hz to 10 Hz ¹	Max voltage (over range)
	B2901A/B2902A	B2911A/B2912A			
±10 nA ²	—	10 fA	±(0.10 % + 50 pA)	≤ 1 pA	±10.5 nA
±100 nA	1 pA	100 fA	±(0.06 % + 100 pA)	≤ 2 pA	±105 nA
±1 µA	10 pA	1 pA	±(0.025 % + 500 pA)	≤ 25 pA	±1.05 µA
±10 µA	100 pA	10 pA	±(0.025 % + 1.5 nA)	≤ 60 pA	±10.5 µA
±100 µA	1 nA	100 pA	±(0.02 % + 25 nA)	≤ 2 nA	±105 µA
±1 mA	10 nA	1 nA	±(0.02 % + 200 nA)	≤ 6 nA	±1.05 mA
±10 mA	100 nA	10 nA	±(0.02 % + 2.5 µA)	≤ 200 nA	±10.5 mA
±100 mA	1 µA	100 nA	±(0.02 % + 20 µA)	≤ 600 nA	±105 mA
±1 A	10 µA	1 µA	±(0.03 % + 1.5 mA)	≤ 70 µA	±1.05 A
±1.5 A	10 µA	1 µA	±(0.05 % + 3.5 mA)	≤ 100 µA	±1.515 A
±3 A	100 µA	10 µA	±(0.4 % + 7 mA)	≤ 120 µA	±3.03 A
±10 A ³	100 µA	10 µA	±(0.4 % + 25 mA) ⁴		±10.5 A

1. Supplemental characteristics
2. 10 nA range is not available for B2901A/B2902A.
3. 10 A range is available only for pulse mode, not available for DC mode.
4. Measurement speed: 0.01 PLC

Source supplemental characteristics

Temperature coefficient (0 to 18°C and 28 to 50°C)	$\pm (0.1 \times \text{accuracy}) / ^\circ\text{C}$
Max output power and source/sink limits	31.8 W $\pm 6 \text{ V} @ \pm 3.03 \text{ A}$, $\pm 21 \text{ V} @ \pm 1.515 \text{ A}$, $\pm 210 \text{ V} @ \pm 105 \text{ mA}$, four quadrant source or sink operation
Current limit/compliance	Accuracy is same as current source. Minimum value is 1 % of range, or 1 nA in 10 nA range.
Voltage limit/compliance	Accuracy is same as voltage source. Minimum value is 1 % of range, or 20 mV in 200 mV range
Over range	101 % of source range for 1.5 A and 3 A ranges. 105 % of source range other than 1.5 A and 3 A ranges. No over range for 200 V range with current exceeding 105 mA pulse only condition.
Over temperature protection	Output turns off then resets at over temperature sensed internally
Voltage output settling time 200 mV, 2 V ranges 20 V range 200 V range	Time required to reach within 0.1 % of final value at open load condition. Step is 10 % to 90 % range < 50 μs < 110 μs < 700 μs
Slew rate	$\leq 0.36 \text{ V}/\mu\text{s}$, 20 V and 10 mA ranges, 10 M Ω load resistance
Current output settling time 10 nA, 100 nA ranges 1 μA range 10 μA , 100 μA ranges 1 mA to 3 A ranges	Time required to reach within 0.1 % (0.3 % for 3 A range) of final value at short condition. Step is 10 % to 90 % range < 10 ms < 500 μs < 250 μs < 80 μs
Noise 10 Hz to 20 MHz (V source)	3 mVrms, 20 V range
V source overshoot	$< \pm(0.1 \% + 10 \text{ mV})$. Step is 10 % to 90 % range, resistive load
I source overshoot	$< \pm 0.1 \% (< \pm 0.3 \% \text{ for } 3 \text{ A range})$. Step is 10 % to 90 % range, resistive load
Voltage source range change overshoot	$\leq 250 \text{ mV}$. 100 k Ω load, 20 MHz bandwidth
Current source range change overshoot	$\leq 250 \text{ mV}/R$ load, 20 MHz bandwidth

Pulse source supplemental characteristics

Minimum programmable pulse width	50 μ s
Pulse width programming resolution	1 μ s
Pulse width definition	The time from 10 % leading to 90 % trailing edge as follows

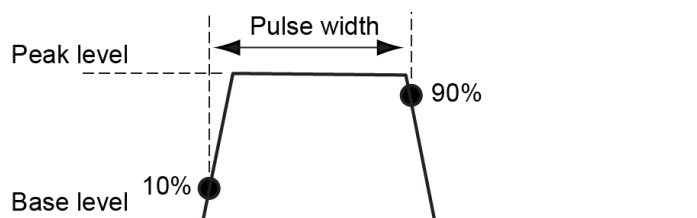

Maximum pulse width and duty cycle

	Pulsed					DC	
	Max voltage	Max peak current	Max base current	Pulse width	Max duty cycle	Max voltage	Max current
DC or pulsed	210 V	0.105 A	0.105 A	50 μ s to 99999.9 s	99.9999 %	210 V	0.105 A
	21 V	1.515 A ¹	1.515 A ¹	50 μ s to 99999.9 s	99.9999 %	21 V	1.515 A ¹
	6 V	3.03A ¹	3.03 A ¹	50 μ s to 99999.9 s	99.9999 %	6 V	3.03 A ¹
Pulsed only	200 V	1.515A	50 mA	50 μ s to 2.5 ms	2.5 %		
	180 V	1.05 A	50 mA	50 μ s to 10 ms	2.5 %		
	6 V ²	5.25 A ²	0.1 A ²	50 μ s to 3 ms ²	3.0 % ²		
	6 V	10.5 A	0.5 A	50 μ s to 1 ms	2.5 %		

1. Max current limitation: For 21 V/1.515 A and 6 V / 3.03 A ranges, total max current is limited by the table in page 13 for using 2 channels. Max current is not limited for using 1 channel only.
2. Valid for the firmware rev. 3.4 or later, and software entitlement certificate are required.

Minimum pulse width at the given voltage, current and settling conditions

Source value	Limit value	Load	Source settling (% of range)	Min pulse width
200 V	1.5 A	200 Ω	0.1%	1 ms
6 V	10.5 A	0.6 Ω	0.1%	0.2 ms
1.5 A	200 V	65 Ω	0.1%	2.5 ms
10.5 A	6 V	0.5 Ω	0.1%	0.2 ms
10.5 A ¹	6 V ¹	0.1 Ω ¹	0.1 % ¹	0.1 ms ¹

1. Valid for the firmware rev. 3.4 or later, and software entitlement certificate are required. Transient speed mode is set to FAST.

Voltage measurement specifications

Range	Measurement resolution		Accuracy (% reading + offset)
	B2901A/B2902A	B2911A/B2912A	
±200 mV	100 nV	100 nV	±(0.015 % + 225 µV)
±2 V	1 µV	1 µV	±(0.02 % + 350 µV)
±20 V	10 µV	10 µV	±(0.015 % + 5 mV)
±200 V	100 µV	100 µV	±(0.015 % + 50 mV)

1. Supplemental characteristics

Current measurement specifications

Range	Measurement resolution		Accuracy (% reading + offset)
	B2901A/B2902A	B2911A/B2912A	
±10 nA ¹	—	10 fA	±(0.10 % + 50 pA)
±100 nA	100 fA	100 fA	±(0.06 % + 100 pA)
±1 µA	1 pA	1 pA	±(0.025 % + 500 pA)
±10 µA	10 pA	10 pA	±(0.025 % + 1.5 nA)
±100 µA	100 pA	100 pA	±(0.02 % + 25 nA)
±1 mA	1 nA	1 nA	±(0.02 % + 200 nA)
±10 mA	10 nA	10 nA	±(0.02 % + 2.5 µA)
±100 mA	100 nA	100 nA	±(0.02 % + 20 µA)
±1 A	1 µA	1 µA	±(0.03 % + 1.5 mA)
±1.5 A	1 µA	1 µA	±(0.05 % + 3.5 mA)
±3 A	10 µA	10 µA	±(0.4 % + 7 mA)
±10 A ²	10 µA	10 µA	±(0.4 % + 25 mA) ³

1. 10 nA range is not available for B2901A/B2902A.
2. 10 A range is available only for pulse mode, not available for DC mode.
3. Measurement speed: 0.01 PLC

Measurement supplemental characteristics

Temperature coefficient (0 to 18°C and 28 to 50°C)	$\pm (0.1 \times \text{accuracy}) / ^\circ\text{C}$
Over range	102 % of measurement range for 1.5 A and 3 A ranges 106 % of measurement range other than 1.5 A and 3 A ranges
Voltage measurement range change overshoot	< 250 mV. 100 k Ω load, 20 MHz bandwidth
Current measurement range change overshoot	< 250 mV/R load, 20 MHz bandwidth
Derating accuracy for measurement speed less than 1 PLC	Add % of range using the following table for measurement with PLC < 1

Derating accuracy with PLC setting < 1 PLC

	Voltage range		Current range			
	0.2 V	2 V to 200 V	10 nA	100 nA	1 μA to 100 mA	1 A to 3 A
0.1 PLC	0.01%	0.01%	0.1%	0.01%	0.01%	0.01%
0.01 PLC	0.05%	0.02%	1%	0.1%	0.05%	0.02%
0.001 PLC	0.5%	0.2%	5%	1%	0.5%	0.2%

Timer and triggering specification

Timer	Time stamp	TIMER value automatically saved when each measurement is triggered
	Trigger timing resolution	1 μs to 100 ms
	Accuracy	± 50 ppm
	Arm/trigger delay	0 μs to 100,000 s
	Arm/trigger interval	B2901A/B2902A : 20 μs to 100,000 s B2911A/B2912A : 10 μs to 100,000 s
	Arm/trigger event	1 to 100,000
Triggering ¹	Digital I/O Trigger in to trigger out	$\leq 5 \mu\text{s}$
	Digital I/O Trigger in to source change	$\leq 5 \mu\text{s}$
	LXI Trigger in to source change	Minimum 100 μs , Typical 200 μs , Maximum Unknown
	LXI Trigger in to measurement	Minimum 100 μs , Typical 200 μs , Maximum Unknown
	Internal event to external LXI trigger output	Minimum 100 μs , Typical 200 μs , Maximum Unknown
	LXI event send/receive latency	Unknown
	Minimum trigger interval	10 μs

1. Supplemental characteristics

Other supplemental characteristics

Output characteristics	
Sensing Modes	2-wire or 4-wire (Remote-sensing) connections
Low terminal connection	Chassis grounded or floating
Output connectors	Banana jack. Triaxial connections are recommended for sourcing and measuring less than 1 nA. A banana jack to triaxial adapter is available for low current measurement.
Output location	Channel 1 at front, and channel 2 at rear
Maximum load	Normal mode: 0.01 μF High Capacitance mode: 50 μF
DC loading voltage	Max ± 250 V DC between low force and chassis ground
Guard offset voltage (V source)	< 4 mV
Remote sense operation range	Max voltage between High Force and High Sense = 3 V Max voltage between Low Force and Low Sense = 3 V
Common mode isolation	> 1 G Ω , < 4500 pF
Maximum sense lead resistance:	1 k Ω for rated accuracy
Sense input impedance	> 10 G Ω

High capacitance mode

The high capacitance mode permits the measurement of devices with capacitances greater than the normal mode maximum load value of 0.01 μF . In high capacitance mode the maximum allowed value of the load capacitance is 50 μF .

Voltage output settling time	Time required to reach within 0.1 % of final value with 4.7 μF capacitive load on a fixed range at specified current range and limit value		
	200 mV, 2 V ranges	600 μs , at 1 A limit	
	20 V range	1.5 ms, at 1 A limit	
	200 V range	20 ms, at 100 mA limit	
Current measurement settling time	Time required to reach within 0.1 % of final value after voltage source is stabilized on fixed range. Vout is 5 V unless noted.		
	1 μA range	230 ms	
	10 μA , 100 μA ranges	23 ms	
	1 mA, 10 mA ranges	0.23 ms	
	100 mA to 3 A ranges	100 μs	
Mode change delay	Delay into high cap mode	1 μA range	230 ms
		10 μA , 100 μA ranges	23 ms
		1 mA to 3 A ranges	1 ms
	Delay out of high cap mode	All ranges	10 ms

Noise 10 Hz to 20 MHz (20 V range)	4.5 mVrms	
Voltage source range change overshoot (20 V range or below)	< 250 mV, 20 MHz bandwidth	
High Capacitance mode working conditions	V/I mode	Voltage source mode only
	Range	Current measurement range is limited to fixed range only. 10 nA and 100 nA ranges are not available.
Current limit	≥ 1 μA	

Resistance measurement

Resistance measurement can be performed under either auto or manual test conditions. Auto resistance measurement is performed in current source and voltage measurement mode. The total auto resistance measurement error is shown in the table below. The total error of a manual resistance measurement can be calculated using the voltage and current accuracy information as shown below.

Source I mode, manual ohm measurement (4-wire)	Total error = $V_{meas}/I_{src} = R \text{ reading} \times (\text{gain error \% of V range} + \text{gain error \% of I range} + \text{offset error of I range}/I_{src} \text{ value \%}) + (\text{offset error of V range}/I_{src} \text{ value})$
Source V mode, manual ohm measurement (4-wire)	Total error = $V_{src}/I_{meas} = 1/[1/R \text{ reading} \times (\text{gain error \% of I range} + \text{gain error \% of V range} + \text{offset error of V range}/V_{src} \text{ value \%}) + (\text{offset error of I range}/V_{src} \text{ value})]$
Measurement speed	1 PLC
Applicable for temperature	23 °C ± 5 °C
Example of total error calculation	I source value = 1 mA at 1 mA range V measure range = 2 V range Total error (% reading + offset) = (0.02 % + 0.02 % + 200 nA/1 mA) + (350 μV/1 mA) = 0.06 % + 0.35 Ω

Typical performance of auto resistance measurement (4-wire), 2 V range

Range	Resolution	Test current	Current range	Total error (% reading + offset)
2 Ω	1 μΩ	1 A	1 A	0.2 % + 0.00035 Ω
20 Ω	10 μΩ	100 mA	100 mA	0.06 % + 0.0035 Ω
200 Ω	100 μΩ	10 mA	10 mA	0.065 % + 0.035 Ω
2 kΩ	1 mΩ	1 mA	1 mA	0.06 % + 0.35 Ω
20 kΩ	10 mΩ	100 μA	100 μA	0.065 % + 3.5 Ω
200 kΩ	100 mΩ	10 μA	10 μA	0.06 % + 35 Ω
2 MΩ	1 Ω	1 μA	1 μA	0.095 % + 350 Ω
20 MΩ	10 Ω	100 nA	100 nA	0.18 % + 3.5 kΩ
200 MΩ	100 Ω	10 nA	100 nA	1.08 % + 35 kΩ

System speeds

Maximum sweep operation reading rates (reading/second) for 50 Hz

Measure speed	Measure to memory	Measure to GPIB	Source measure to memory	Source measure to GPIB
< 0.001 PLC	20000	12500	19500	12500
0.01 PLC	4500	3950	4500	3950
0.1 PLC	500	490	500	490
1 PLC	49	49	49	49

Operation reading rate varies by number of sweep steps. Number of sweep steps is specified.

Environmental specifications

Environment	For use in indoor facilities
Operating	0 °C to +55 °C, 30 % to 80 % non-condensing
Storage	-30 °C to 70 °C, 10 % to 90 % non-condensing
Altitude	Operating: 0 m to 2000 m, Storage: 0 m to 4600 m
Power supply	90 V to 264 V, 47 Hz to 63 Hz, 250 VA maximum
EMC	IEC61326-1/EN61326-1, AS/NZS CISPR 11, KC: RRA Notification amending Radio Waves Act Article 58-2
Safety	IEC61010-1/EN61010-1, CAN/CSA-C22.2 No. 61010-1-04, C/US
Certifications	CE, cCSAus, C-Tick, KC
Warm-up	1 hour
Dimensions	Case 88 mm (2U) x 213 mm (half width) x 450 mm
	Working 180 mm x 260 mm x 480 mm (with handle & feet)
Weight	Net 5.1 kg (B2901A, B2911A), 6.5 kg (B2902A, B2912A)
	Shipping 7.6 kg (B2901A, B2911A), 9.0 kg (B2902A, B2912A)

Front panel operation

Front panel interface	4.3" TFT color display (480x272, with LED backlight) with keypads and rotary knob
View mode	Single view, Dual view, Graph view and Roll view
Hardkeys	Single Trigger and Auto Trigger control, 10-key, Rotary Knob and Cursors, Channel on/off, View, Cancel/Local
Softkeys	Function, System and Input Assist Keys
Indicators	Channel (measurement) status, System status

Source/measurement capabilities

Sweep measurement	
Number of steps	1 to 100,000 ¹
Sweep mode	Linear, logarithmic (log) or list
Sweep direction	Single or double
Type	DC, or pulse
Min programmable value to create list sweep waveform	B2901A/B2902A: Min 20 μ s with 1 μ s resolution B2911A/B2912A: Min 10 μ s with 1 μ s resolution

- Valid for the models with S/N below or later, firmware rev. 3.1 or later, and software entitlement certificate are required.
B2901A MY51140470
B2902A MY51140683
B2911A MY51140213
B2192A MY51140498
"1 to 2,500" for the models with other S/N.

Digitizing/sampling measurement	
Min trigger interval (Max speed of measurement)	B2901A/B2902A: 20 μ s (50,000 points/s) B2911A/B2912A: 10 μ s (100,000 points/s)

Data buffers	
Max buffer size	100,000 points / channel

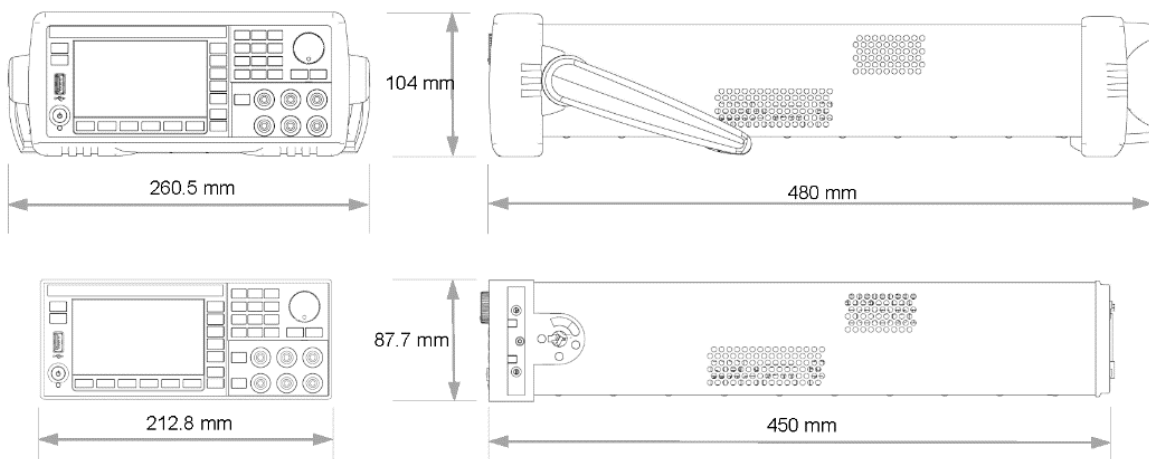

Input/Output connectivity

GP-IB		IEEE-488.2
Ethernet		100BASE-T / 10BASE-T
USB		USB 2.0 host controller (front) USB 2.0 device interface (rear)
Digital I/O	Connector type	25-pin female D.
	Input/output pins	14 open drain I/O bits
	Absolute max input voltage	5.25 V
	Absolute min input voltage	- 0.25 V
	Max logic L input voltage	0.8 V
	Min logic H input voltage	2.0 V
	Max source current	1 mA @ Vout = 0 V
	Max sink current	50 mA @ Vout = 5 V
	5 V power supply pin	Limited to 500 mA, solid state fuse protected
	Safety interlock pin:	One active high pin and one active low pin. Activation of both pin enables output voltage > 42 V
	Maximum number of simultaneously triggered units (using Digital I/O)¹:	8

1. Supplemental characteristic

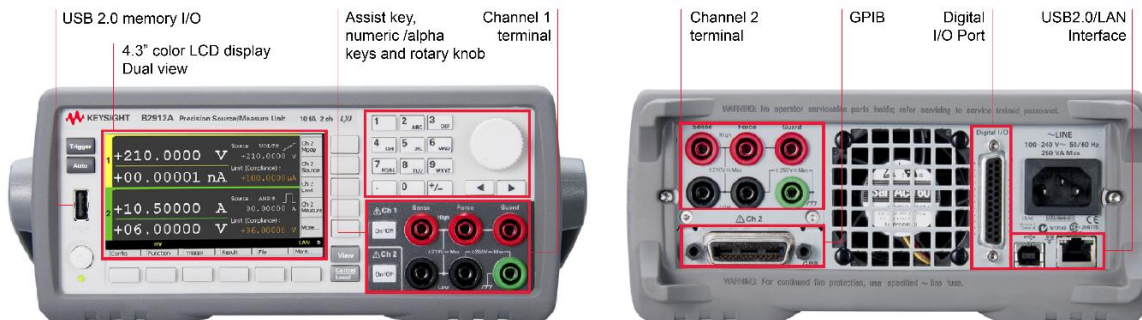

Program, software and drivers

Programming	SCPI
Program memory	100 kB (2500 lines typical)
LXI compliance	LXI Core 2011
Software available	EasyEXPERT group+, Quick I/V Measurement Software, Graphical Web Interface, BenchVue
Drivers available	IVI-C, IVI-COM drivers, LabVIEW drivers

Software prerequisites

EasyEXPERTgroup+	Operating system	Microsoft Windows Vista Business SP2 or later (32bit), Microsoft Windows 7 Professional SP1 or later (32bit/64bit), Microsoft Windows 8.1 Professional or later (32bit/64bit), Microsoft Windows 10 Pro or later (32bit/64bit)
	Supporting language	English (US)
	.NET Framework	Microsoft .NET, Framework 3.5 SP1
	IO Libraries	Keysight IO Libraries Suite 16.2, 16.3, 17.1 update 1 or later (for the Online execution mode)
	Memory	2 GB memory
	Display	XGA 1024 x 768 (SXGA 1280 x 1024 recommended)
	HDD	Installation: 1GB free disk space on the C drive, Test setup/result data storage: Free disk space more than 30GB is recommended
	Recommended GPIB I/F	Keysight 82350B/C (PCI) ¹ , 82351B(PCIe) ¹ , 82357A (USB) ^{2,3} , 82357B (USB) ^{2,3} National Instrument: GPIB-USB-HS (USB) ^{2,1}
Quick IV	Operating system	Windows 7 (32 bit/64 bit), Windows 8 (32 bit/64 bit), Windows 8.1 (32 bit/64 bit), Windows 10 (32 bit/64 bit),
	Supporting language	English (US)
	.NET Framework	Microsoft .NET, Framework 4.5.2
	IO Libraries	17.0 or later
	Interfaces	USB, GP-IB, LAN
BenchVue	Operating system	Windows 10 32-bit and 64-bit (Professional, Enterprise, Education, Home versions) Windows 8 32-bit and 64-bit (Professional, Enterprise, Core) Windows 7 SP1 and later 32-bit and 64-bit (Professional, Enterprise, Ultimate, Home Basic, Home Premium)
	HDD	Processor: 1 GHz or faster (2 GHz or greater recommended) RAM: 1GB (32-bit) or 2GB (64-bit) (3GB or greater recommended)
	Display resolution	1024 x 768 minimum for single instrument view (higher resolutions are recommended for multiple instrument view)
	Interfaces	USB, GPIB, LAN, RS-232

1. A PCI or PCIe card is highly recommended because of stability and speed.
2. USB GPIB interfaces might cause serial poll error intermittently due to the intrinsic communication scheme differences. It is reported that using an even GPIB address sometimes significantly decreases the chance of the error. The NI GPIB-USB-HS is recommended for stability, and the Keysight 82357x is recommended for speed.
3. EasyEXPERT software prohibits to set the odd GPIB address to prevent the issue above.

Furnished Accessories

Power cable, USB cable, Quick Reference (English), CD-ROMs (including PDF manuals, Quick I/V Measurement Software and drivers, EasyEXPERT group+ install media), Keysight I/O Library Suite

Ordering Information

Model number	
B2901A	Precision Source/Measure Unit, 1ch, 100 fA, 210 V, 3 A DC/10.5 A pulse
B2902A	Precision Source/Measure Unit, 2ch, 100 fA, 210 V, 3 A DC/10.5 A pulse
B2911A	Precision Source/Measure Unit, 1ch, 10 fA, 210 V, 3 A DC/10.5 A pulse
B2912A	Precision Source/Measure Unit, 2ch, 10 fA, 210 V, 3 A DC/10.5 A pulse
Options	
0B0	Download the Product Manual from the Keysight website
ABA	User Guide English for B2900 Series
ABJ	User Guide Japanese for B2900 Series
A6J	ANSI Z540-1-1994 Calibration
UK6	Commercial Calibration Certificate with Test Data
Accessories	
N1294A-001	Banana - Triax adapter for 2-wire (non Kelvin) connection
N1294A-002	Banana - Triax adapter for 4-wire (Kelvin) connection
N1294A-011	Interlock cable for 16442B (1.5 m)
N1294A-012	Interlock cable for 16442B (3.0 m)
N1294A-031	GPIO-BNC trigger adapter
N1294A-032	Digital I/O trigger cable for multiple unit control
16494A-001	Low leakage triax cable (1.5 m)
16494A-002	Low leakage triax cable (3.0 m)
16494A-005	Low leakage triax cable (4.0 m)
34190A	Rack Mount Kit
Upgrade kit	
B2901AU	B2901A Software Upgrade Package, Extension Support and Subscription
B2902AU	B2902A Software Upgrade Package, Extension Support and Subscription
B2911AU	B2911A Software Upgrade Package, Extension Support and Subscription
B2912AU	B2912A Software Upgrade Package, Extension Support and Subscription

Learn more at: www.keysight.com

For more information on Keysight Technologies' products, applications or services, please contact your local Keysight office. The complete list is available at: www.keysight.com/find/contactus

