

ALA7D, Aluminum Electrolytic, 85C, 390 uF, 20%, 500 VDC, -40/+85C

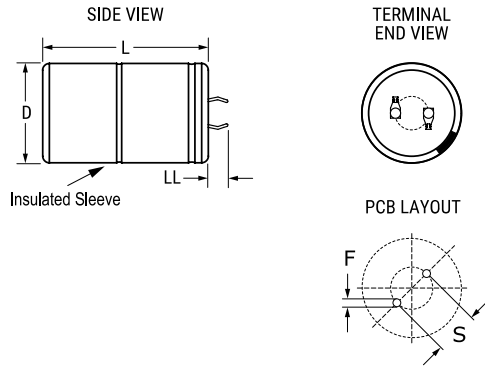

Dimensions	
D	30mm +1mm
L	50mm +/-2mm
S	10mm +/-0.1mm
LL	6.3mm +/-1mm
F	2mm +/-0.1mm

Packaging Specifications	
Weight:	60 g
Packaging:	Bulk, Bag
Packaging Quantity:	160

General Information	
Supplier:	KEMET
Series:	ALA7D
Dielectric:	Aluminum Electrolytic
Description:	Snap-In, Aluminum Electrolytic
RoHS:	Yes
Lead:	2 Pin
Qualifications:	AEC-Q200
AEC-Q200:	Yes
Miscellaneous:	Vibration: <= 35mm 1.5mm displacement amplitude or 20G maximum acceleration. Vibration applied for three directions of 4-hour sessions at 10 – 2,000 Hz. (Capacitor clamped by body.)
Shelf Life:	156 Weeks

Specifications	
Capacitance:	390 uF
Capacitance Tolerance:	20%
Voltage DC:	500 VDC, 550 VDC (Surge)
Temperature Range:	-40/+85C
Rated Temperature:	85°C
Life:	13000 Hrs (Rated Voltage And Ripple Current At 85C), 21000 Hrs (Rated Voltage at 85C)
Resistance:	636 mOhms (100Hz 20C), 481.2 mOhms (10kHz 20C)
Ripple Current:	2.12 Amps (100Hz 85C), 4.12 Amps (10kHz 85C)
Leakage Current:	1170 uA (5min 20C)

Statements of suitability for certain applications are based on our knowledge of typical operating conditions for such applications, but are not intended to constitute - and we specifically disclaim - any warranty concerning suitability for a specific customer application or use. This Information is intended for use only by customers who have the requisite experience and capability to determine the correct products for their application. Any technical advice inferred from this Information or otherwise provided by us with reference to the use of our products is given gratis, and we assume no obligation or liability for the advice given or results obtained.