

# IMF Inductive sensors: Robust and powerful

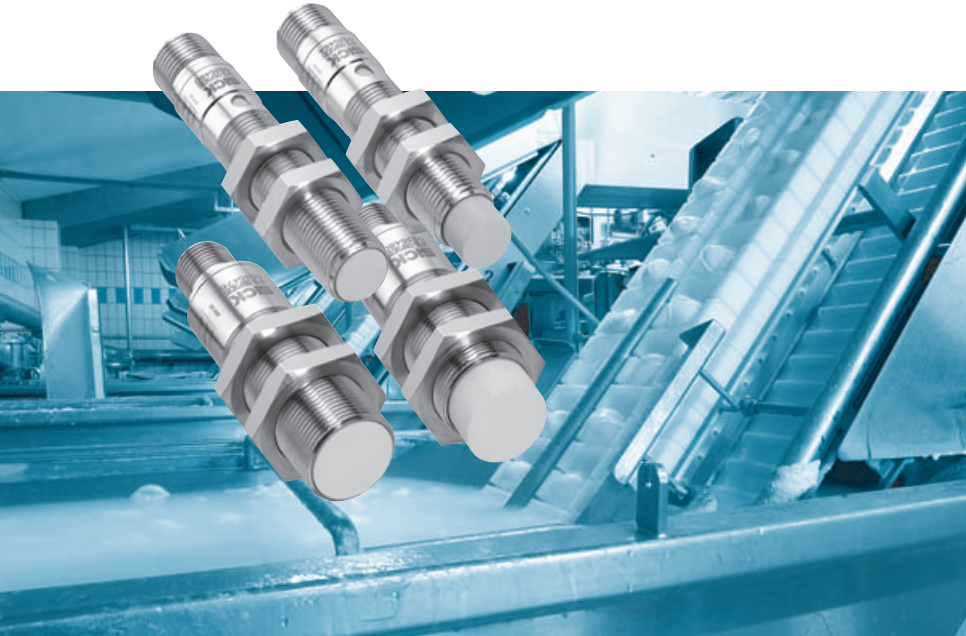

Only a few suppliers can meet all these demands. At the forefront of progress: SICK's Food & Beverage sensor solutions, developed on the basis of many years' experience and collaboration with producers in this sector.

SICK sensors for the food and beverage industry are proven in harsh environment thousand of times and every day.



**A**utomated food production poses extreme challenges for machine constructors. Cleaning processes complying with regulations place enormous loads on machine electronics, particularly on the sensors at the "front" of process control. They must withstand humidity, high process and cleaning temperatures, aggressive agents and cleaning pressures of up to 100 bar, and are still expected to work properly for many years.

Your benefit is our aim:

- Greater machine availability through reliable sensors
- Hygienic processes through appropriate sensor housing material and design
- Resistant against all common detergents – certified by independent institutes.

The inductive sensors for Food & Beverage have been specially developed to meet your needs. Convince yourself of the optimum mix of product performance and properties.

# Installation notes

## Installation in metal

The following notes are necessary to get proper operation.

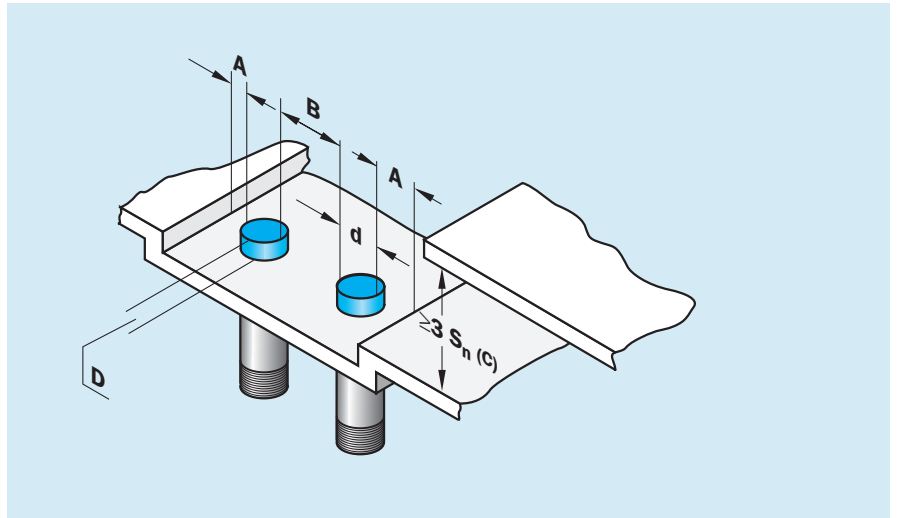

d = Outer diameter of the sensor

Type	Metal-free zone [mm]
IMF12-02B...	A ≥ 6, B ≥ 12, C ≥ 6, D ≥ 0
IMF12-04N...	A ≥ 12, B ≥ 24, C ≥ 12, D ≥ 6
IMF12-04B...	A ≥ 6, B ≥ 12, C ≥ 12, D ≥ 0
IMF12-08N...	A ≥ 12, B ≥ 24, C ≥ 24, D ≥ 12

## Reduction factor $R_m$

The following are reference values, which may vary from type to type:

St37	$R_m = 1$
Stainless steel	$R_m = \text{approx. } 0.7$
Aluminium	$R_m = \text{approx. } 0.3$
Copper	$R_m = \text{approx. } 0.25$

# Installation notes

## Installation in metal

The following notes are necessary to get proper operation.

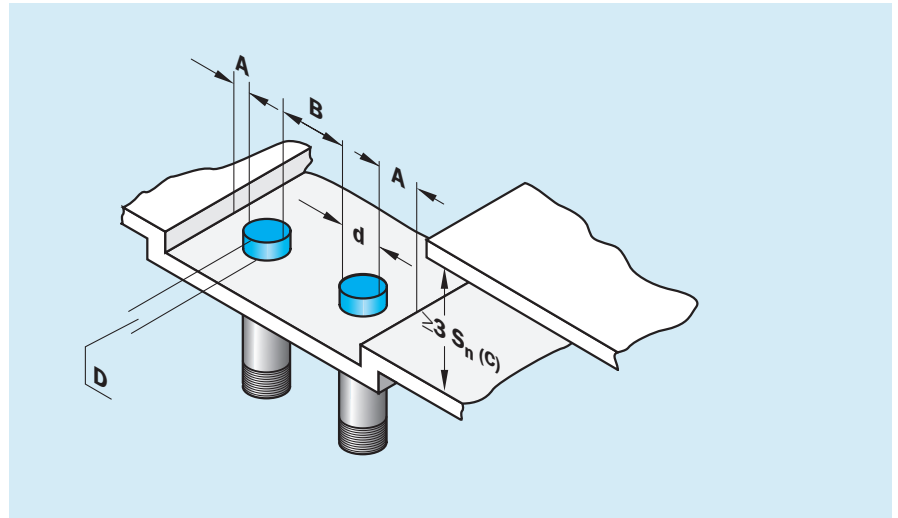

d = Outer diameter of the sensor

Type	Metal-free zone [mm]
IMF18-05B...	A ≥ 9, B ≥ 18, C ≥ 15, D ≥ 3.6
IMF18-08N...	A ≥ 18, B ≥ 36, C ≥ 24, D ≥ 12
IMF18-08B...	A ≥ 9, B ≥ 18, C ≥ 24, D ≥ 1.8
IMF18-12N...	A ≥ 18, B ≥ 36, C ≥ 36, D ≥ 16

## Reduction factor $R_m$

The following are reference values, which may vary from type to type:

St37	$R_m = 1$
Stainless steel	$R_m = \text{approx. } 0.7$
Aluminium	$R_m = \text{approx. } 0.3$
Copper	$R_m = \text{approx. } 0.25$

# IMF12 Inductive sensor, standard series, flush

	<b>Sensing range</b>
	<b>2 mm</b>
<b>Inductive sensor</b>	

- Robust stainless steel housing 316L/1.4404
- Enclosure rating IP 69K und IP 68
- Extended temperature range -40 °C ... +80 °C, +100 °C for 15 minutes

## Dimensional drawing

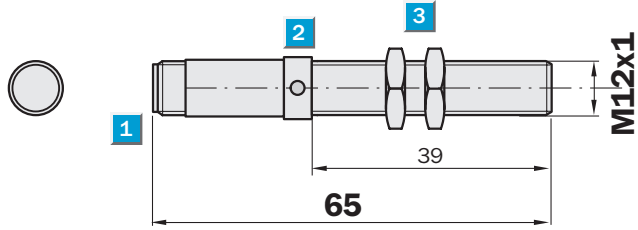

- 1** Connection
- 2** Display LED
- 3** Fastening nuts (2 x), width across 17, stainless steel (316L/1.4404)



## Connection type

IMF12-02BNSVCOS	IMF12-02BNOVCOS	IMF12-02BNPVCOS
IMF12-02BPSVCOS	IMF12-02BPVCOS	IMF12-02BPPVCOS

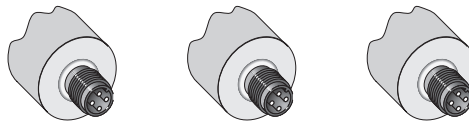

M12, 4-pin

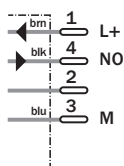

M12, 4-pin

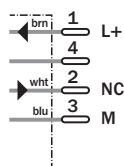

M12, 4-pin

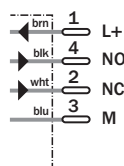

<b>Accessories</b>
Mounting systems
Stainless steel 316L/1.4404
Connecting cables
"Food & Beverage", M12, 4-pin
Extension cables
"Food & Beverage", M12, 4-pin
Sensor splitter-box
"Food & Beverage"

Technical data		IMF12	02BPS VCOS	02BNS VCOS	02BPO VCOS	02BNO VCOS	02BPP VCOS	02BNP VCOS				
<b>Sensing range <math>S_n</math></b>	2 mm											
<b>Electrical configuration</b>	DC 3-wire											
	DC 4-wire											
	10 ... 30 V DC											
Ripple $V_{pp}$	$\leq 10 \%$											
Voltage drop $U_d$	$\leq 2 V^{1)}$											
Power consumption	$\leq 15 mA^{2)}$											
<b>Continuous current <math>I_A</math></b>	$\leq 200 mA$											
Time delay before availability $t_v$	Approx. 50 ms											
Hysteresis H, of $s_r$	1 ... 20 %											
Repeatability R	5 % ( $V_S$ and $T_a$ constant) <sup>3)</sup>											
Temperature drift, of $S_r$	10 %											
EMC	According to EN 60947-5-2											
<b>Switching output</b>	PNP											
	NPN											
<b>Output function</b>	Normally open											
	Normally closed											
	Complementary											
<b>Installation</b>	Flush											
<b>Connection type</b>	Connector M12, 4-pin, gold-plated											
<b>Enclosure rating</b>	IP 68 <sup>4)</sup> , IP 69K <sup>5)</sup>											
Max. switching frequency	2,000 Hz											
Dimensions	M12x1 <sup>6)</sup>											
<b>Short-circuit protection<sup>7)</sup></b>	✓											
<b>Reverse polarity protection</b>	✓											
<b>Power-up pulse suppression</b>	✓											
Shock/vibration stress	30 g, 11 ms/10 ... 55 Hz											
Ambient temperature $T_a$	-40 ... +80 °C, +100 °C for 15 minutes											
<b>Housing material</b>	Stainless steel 316L/1.4404, PPS (FDA certified)											
Tightening torque	20 Nm											

1) At  $I_A$  max.

2) Without load

3) Of  $S_r$ 

4) According to EN 60529

5) According to EN 40050

6) Thread diameter x pitch (mm)

7) Pulsed

Order information	
Type	Order no.
IMF12-02BPSVCOS	6035452
IMF12-02BNSVCOS	6035453
IMF12-02BPOVCOS	6035454
IMF12-02BNOVCOS	6035455
IMF12-02BPPVCOS	6035215
IMF12-02BNPVCOS	6035216

	<b>Sensing range</b>
	<b>4 mm</b>
<b>Inductive sensor</b>	

- Robust stainless steel housing 316L/1.4404
- Enclosure rating IP 69K und IP 68
- Extended temperature range -40 °C ... +80 °C, +100 °C for 15 minutes

**Dimensional drawing**

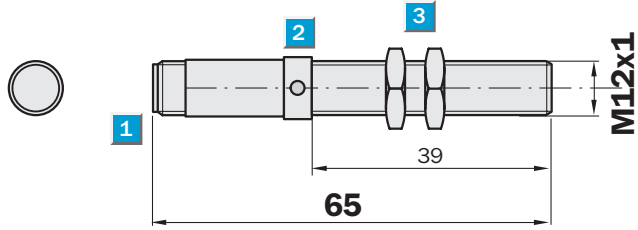

- 1** Connection
- 2** Display LED
- 3** Fastening nuts (2 x), width across 17, stainless steel (316L/1.4404)

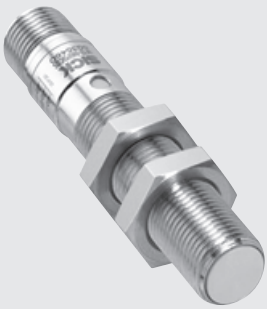

**Connection type**

IMF12-04BNSVCOS	IMF12-04BNOVCOS	IMF12-04BNPVCOS
IMF12-04BPSVCOS	IMF12-04BPVCOS	IMF12-04BPPVCOS

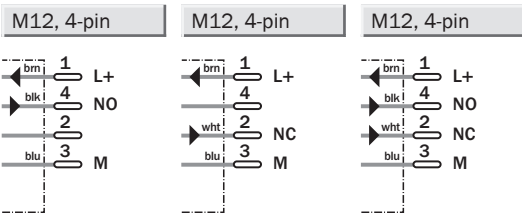
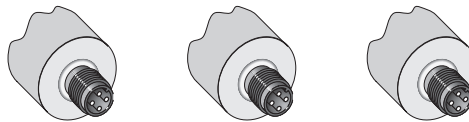

<b>Accessories</b>
Mounting systems
Stainless steel 316L/1.4404
Connecting cables
"Food & Beverage", M12, 4-pin
Extension cables
"Food & Beverage", M12, 4-pin
Sensor splitter-box
"Food & Beverage"

Technical data		IMF12	04BPS VCOS	04BNS VCOS	04BPO VCOS	04BNO VCOS	04BPP VCOS	04BNP VCOS				
<b>Sensing range <math>S_n</math></b>	4 mm											
<b>Electrical configuration</b>	DC 3-wire											
	DC 4-wire											
	10 ... 30 V DC											
Ripple $V_{pp}$	$\leq 10 \%$											
Voltage drop $U_d$	$\leq 2 V^{1)}$											
Power consumption	$\leq 15 mA^{2)}$											
<b>Continuous current <math>I_A</math></b>	$\leq 200 mA$											
Time delay before availability $t_v$	Approx. 50 ms											
Hysteresis H, of $s_r$	1 ... 20 %											
Repeatability R	5 % ( $V_S$ and $T_a$ constant) <sup>3)</sup>											
Temperature drift, of $S_r$	10 %											
EMC	According to EN 60947-5-2											
<b>Switching output</b>	PNP											
	NPN											
<b>Output function</b>	Normally open											
	Normally closed											
	Complementary											
<b>Installation</b>	Flush											
<b>Connection type</b>	Connector M12, 4-pin, gold-plated											
<b>Enclosure rating</b>	IP 68 <sup>4)</sup> , IP 69K <sup>5)</sup>											
Max. switching frequency	2,000 Hz											
Dimensions	M12x1 <sup>6)</sup>											
<b>Short-circuit protection<sup>7)</sup></b>	✓											
<b>Reverse polarity protection</b>	✓											
<b>Power-up pulse suppression</b>	✓											
Shock/vibration stress	30 g, 11 ms/10 ... 55 Hz											
Ambient temperature $T_a$	-40 ... +80 °C, +100 °C for 15 minutes											
<b>Housing material</b>	Stainless steel 316L/1.4404, PPS (FDA certified)											
Tightening torque	20 Nm											

1) At  $I_A$  max.

2) Without load

3) Of  $S_r$ 

4) According to EN 60529

5) According to EN 40050

6) Thread diameter x pitch (mm)

7) Pulsed

Order information	
Type	Order no.
IMF12-04BPSVCOS	6035460
IMF12-04BNSVCOS	6035461
IMF12-04BPOVCOS	6035462
IMF12-04BNOVCOS	6035463
IMF12-04BPPVCOS	6035219
IMF12-04BNPVCOS	6035220

	<b>Sensing range</b>
	<b>4 mm</b>
<b>Inductive sensor</b>	

- Robust stainless steel housing 316L/1.4404
- Enclosure rating IP 69K und IP 68
- Extended temperature range  
-40 °C ... +80 °C,  
+100 °C for 15 minutes

**Dimensional drawing**

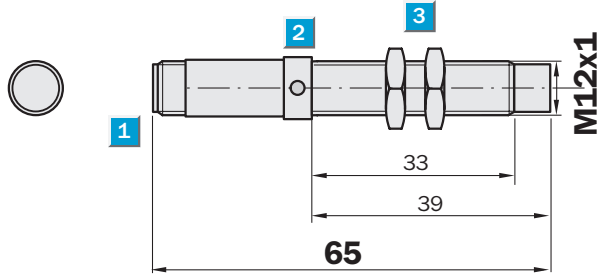

- 1** Connection
- 2** Display LED
- 3** Fastening nuts (2 x), width across 17, stainless steel (316L/1.4404)



**Connection type**

IMF12-04NNSVCOS	IMF12-04NNOVCOS	IMF12-04NNPVCOS
IMF12-04NPSVCOS	IMF12-04NPOVCOS	IMF12-04NPPVCOS

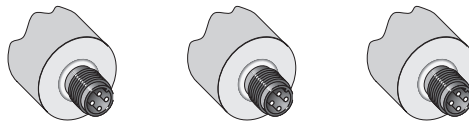

M12, 4-pin

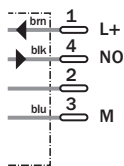

M12, 4-pin

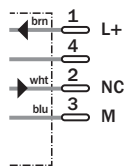

M12, 4-pin

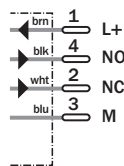

<b>Accessories</b>
Mounting systems
Stainless steel 316L/1.4404
Connecting cables
"Food & Beverage", M12, 4-pin
Extension cables
"Food & Beverage", M12, 4-pin
Sensor splitter-box
"Food & Beverage"



Technical data		IMF12	04NPS VCOS	04NNS VCOS	04NPO VCOS	04NNO VCOS	04NPP VCOS	04NNP VCOS				
<b>Sensing range <math>S_n</math></b>	4 mm											
<b>Electrical configuration</b>	DC 3-wire											
	DC 4-wire											
	10 ... 30 V DC											
Ripple $V_{pp}$	$\leq 10\%$											
Voltage drop $U_d$	$\leq 2\text{ V}^{1)}$											
Power consumption	$\leq 15\text{ mA}^{2)}$											
<b>Continuous current <math>I_A</math></b>	$\leq 200\text{ mA}$											
Time delay before availability $t_v$	Approx. 50 ms											
Hysteresis H, of $s_r$	1 ... 20 %											
Repeatability R	5 % ( $V_S$ and $T_a$ constant) <sup>3)</sup>											
Temperature drift, of $S_r$	10 %											
EMC	According to EN 60947-5-2											
<b>Switching output</b>	PNP											
	NPN											
<b>Output function</b>	Normally open											
	Normally closed											
	Complementary											
<b>Installation</b>	Non-flush											
<b>Connection type</b>	Connector M12, 4-pin, gold-plated											
<b>Enclosure rating</b>	IP 68 <sup>4)</sup> , IP 69K <sup>5)</sup>											
Max. switching frequency	2,000 Hz											
Dimensions	M12x1 <sup>6)</sup>											
<b>Short-circuit protection<sup>7)</sup></b>	✓											
<b>Reverse polarity protection</b>	✓											
<b>Power-up pulse suppression</b>	✓											
Shock/vibration stress	30 g, 11 ms/10 ... 55 Hz											
Ambient temperature $T_a$	-40 ... +80 °C, +100 °C for 15 minutes											
<b>Housing material</b>	Stainless steel 316L/1.4404, PPS (FDA certified)											
Tightening torque	20 Nm											

1) At  $I_A$  max.

2) Without load

3) Of  $S_r$ 

4) According to EN 60529

5) According to EN 40050

6) Thread diameter x pitch (mm)

7) Pulsed

Order information	
Type	Order no.
IMF12-04NPSVCOS	6035456
IMF12-04NNSVCOS	6035457
IMF12-04NPOVCOS	6035458
IMF12-04NNOVCOS	6035459
IMF12-04NPPVCOS	6035217
IMF12-04NNPVCOS	6035218

**Sensing range**  
8 mm

Inductive sensor

- Robust stainless steel housing 316L/1.4404
- Enclosure rating IP 69K and IP 68
- Extended temperature range  
-40 °C ... +80 °C,  
+100 °C for 15 minutes

Dimensional drawing

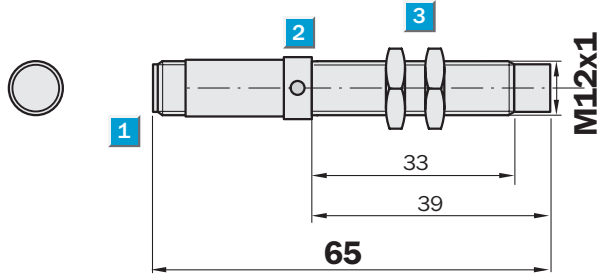

- 1 Connection
- 2 Display LED
- 3 Fastening nuts (2 x), width across 17, stainless steel (316L/1.4404)



Connection type

IMF12-08NNSVCOS	IMF12-08NNOVCOS	IMF12-08NNPVCOS
IMF12-08NPSVCOS	IMF12-08NPOVCOS	IMF12-08NPPVCOS

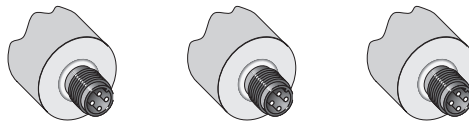

M12, 4-pin

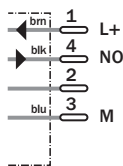

M12, 4-pin

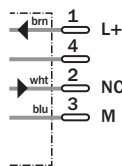

M12, 4-pin

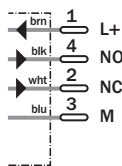

Accessories

Mounting systems
Stainless steel 316L/1.4404
Connecting cables
"Food & Beverage", M12, 4-pin
Extension cables
"Food & Beverage", M12, 4-pin
Sensor splitter-box
"Food & Beverage"

Technical data		IMF12	08NPS VCOS	08NNS VCOS	08NPO VCOS	08NNO VCOS	08NPP VCOS	08NNP VCOS				
<b>Sensing range <math>S_n</math></b>	8 mm											
<b>Electrical configuration</b>	DC 3-wire											
	DC 4-wire											
	10 ... 30 V DC											
Ripple $V_{pp}$	$\leq 10\%$											
Voltage drop $U_d$	$\leq 2\text{ V}^{1)}$											
Power consumption	$\leq 15\text{ mA}^{2)}$											
<b>Continuous current <math>I_A</math></b>	$\leq 200\text{ mA}$											
Time delay before availability $t_v$	Approx. 50 ms											
Hysteresis H, of $s_r$	1 ... 20 %											
Repeatability R	5 % ( $V_S$ and $T_a$ constant) <sup>3)</sup>											
Temperature drift, of $S_r$	10 %											
EMC	According to EN 60947-5-2											
<b>Switching output</b>	PNP											
	NPN											
<b>Output function</b>	Normally open											
	Normally closed											
	Complementary											
<b>Installation</b>	Non-flush											
<b>Connection type</b>	Connector M12, 4-pin, gold-plated											
<b>Enclosure rating</b>	IP 68 <sup>4)</sup> , IP 69K <sup>5)</sup>											
Max. switching frequency	2,000 Hz											
Dimensions	M12x1 <sup>6)</sup>											
<b>Short-circuit protection<sup>7)</sup></b>	✓											
<b>Reverse polarity protection</b>	✓											
<b>Power-up pulse suppression</b>	✓											
Shock/vibration stress	30 g, 11 ms/10 ... 55 Hz											
Ambient temperature $T_a$	-40 ... +80 °C, +100 °C for 15 minutes											
<b>Housing material</b>	Stainless steel 316L/1.4404, PPS (FDA certified)											
Tightening torque	20 Nm											

1) At  $I_A$  max.

2) Without load

3) Of  $S_r$ 

4) According to EN 60529

5) According to EN 40050

6) Thread diameter x pitch (mm)

7) Pulsed

Order information	
Type	Order no.
IMF12-08NPSVCOS	6035464
IMF12-08NNSVCOS	6035465
IMF12-08NPOVCOS	6035466
IMF12-08NNOVCOS	6035467
IMF12-08NPPVCOS	6035221
IMF12-08NNPVCOS	6035222

	<b>Sensing range</b>
	<b>5 mm</b>
<b>Inductive sensor</b>	

- Robust stainless steel housing 316L/1.4404
- Enclosure rating IP 69K and IP 68
- Extended temperature range -40 °C ... +80 °C, +100 °C for 15 minutes

**Dimensional drawing**

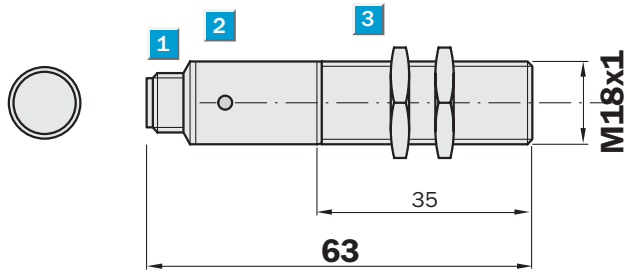

- 1** Connection
- 2** Display LED
- 3** Fastening nuts (2 x), width across 24, stainless steel (316L/1.4404)



**Connection type**

IMF18-05BNSVC0S	IMF18-05BNOVC0S	IMF18-05BNPVC0S
IMF18-05BPSVC0S	IMF18-05BP0VC0S	IMF18-05BPPVC0S

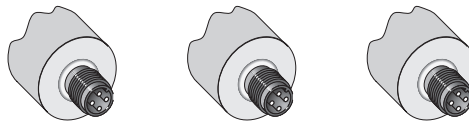

M12, 4-pin

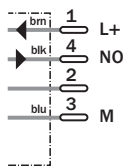

M12, 4-pin

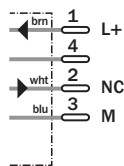

M12, 4-pin

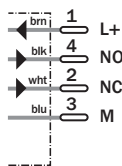

<b>Accessories</b>
Mounting systems
Stainless steel 316L/1.4404
Connecting cables
"Food & Beverage", M12, 4-pin
Extension cables
"Food & Beverage", M12, 4-pin
Sensor splitter-box
"Food & Beverage"

Technical data		IMF18	05BPS VCOS	05BNS VCOS	05BPO VCOS	05BNO VCOS	05BPP VCOS	05BNP VCOS				
<b>Sensing range <math>S_n</math></b>	5 mm											
<b>Electrical configuration</b>	DC 3-wire											
	DC 4-wire											
	10 ... 30 V DC											
Ripple $V_{pp}$	$\leq 10 \%$											
Voltage drop $U_d$	$\leq 2 V^{1)}$											
Power consumption	$\leq 15 mA^{2)}$											
<b>Continuous current <math>I_A</math></b>	$\leq 200 mA$											
Time delay before availability $t_v$	Approx. 50 ms											
Hysteresis H, of $s_r$	1 ... 20 %											
Repeatability R	5 % ( $V_S$ and $T_a$ constant) <sup>3)</sup>											
Temperature drift, of $S_r$	10 %											
EMC	According to EN 60947-5-2											
<b>Switching output</b>	PNP											
	NPN											
<b>Output function</b>	Normally open											
	Normally closed											
	Complementary											
<b>Installation</b>	Flush											
<b>Connection type</b>	Connector M12, 4-pin, gold-plated											
<b>Enclosure rating</b>	IP 68 <sup>4)</sup> , IP 69K <sup>5)</sup>											
Max. switching frequency	1,700 Hz											
Dimensions	M18x1 <sup>6)</sup>											
<b>Short-circuit protection<sup>7)</sup></b>	✓											
<b>Reverse polarity protection</b>	✓											
<b>Power-up pulse suppression</b>	✓											
Shock/vibration stress	30 g, 11 ms/10 ... 55 Hz											
Ambient temperature $T_a$	-40 ... +80 °C, +100 °C for 15 minutes											
<b>Housing material</b>	Stainless steel 316L/1.4404, PPS (FDA certified)											
Tightening torque	50 Nm											

1) At  $I_A$  max.

2) Without load

3) Of  $S_r$ 

4) According to EN 60529

5) According to EN 40050

6) Thread diameter x pitch (mm)

7) Pulsed

Order information	
Type	Order no.
IMF18-05BPSVCOS	6035468
IMF18-05BNSVCOS	6035469
IMF18-05BPOVCOS	6035470
IMF18-05BNOVCOS	6035471
IMF18-05BPPVCOS	6035223
IMF18-05BNPVCOS	6035224

	<b>Sensing range</b>
	<b>8 mm</b>
<b>Inductive sensor</b>	

- Robust stainless steel housing 316L/1.4404
- Enclosure rating IP 69K and IP 68
- Extended temperature range -40 °C ... +80 °C, +100 °C for 15 minutes

**Dimensional drawing**

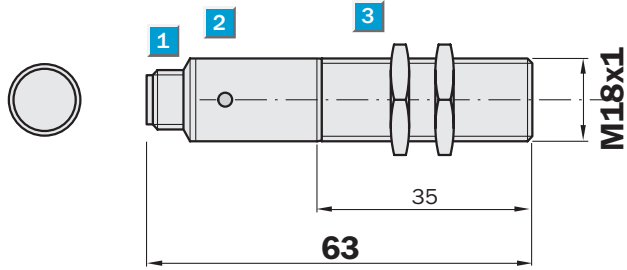

- 1** Connection
- 2** Display LED
- 3** Fastening nuts (2 x), width across 24, stainless steel (316L/1.4404)



**Connection type**

IMF18-08BNSVCOS	IMF18-08BNOVCOS	IMF18-08BNPVCOS
IMF18-08BPSVCOS	IMF18-08BPVCOS	IMF18-08BPPVCOS

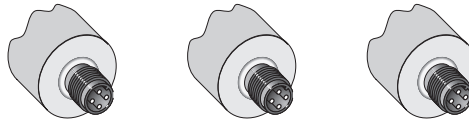

M12, 4-pin

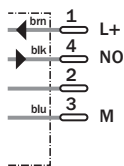

M12, 4-pin

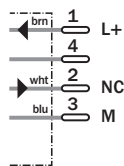

M12, 4-pin

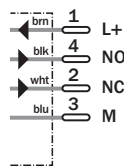

<b>Accessories</b>
Mounting systems
Stainless steel 316L/1.4404
Connecting cables
"Food & Beverage", M12, 4-pin
Extension cables
"Food & Beverage", M12, 4-pin
Sensor splitter-box
"Food & Beverage"

Technical data		IMF18	08BPS VCOS	08BNS VCOS	08BPO VCOS	08BNO VCOS	08BPP VCOS	08BNP VCOS				
<b>Sensing range <math>S_n</math></b>	8 mm											
<b>Electrical configuration</b>	DC 3-wire											
	DC 4-wire											
	10 ... 30 V DC											
Ripple $V_{pp}$	$\leq 10\%$											
Voltage drop $U_d$	$\leq 2\text{ V}^{1)}$											
Power consumption	$\leq 15\text{ mA}^{2)}$											
<b>Continuous current <math>I_A</math></b>	$\leq 200\text{ mA}$											
Time delay before availability $t_v$	Approx. 50 ms											
Hysteresis H, of $s_r$	1 ... 20 %											
Repeatability R	5 % ( $V_S$ and $T_a$ constant) <sup>3)</sup>											
Temperature drift, of $S_r$	10 %											
EMC	According to EN 60947-5-2											
<b>Switching output</b>	PNP											
	NPN											
<b>Output function</b>	Normally open											
	Normally closed											
	Complementary											
<b>Installation</b>	Flush											
<b>Connection type</b>	Connector M12, 4-pin, gold-plated											
<b>Enclosure rating</b>	IP 68 <sup>4)</sup> , IP 69K <sup>5)</sup>											
Max. switching frequency	1,700 Hz											
Dimensions	M18x1 <sup>6)</sup>											
<b>Short-circuit protection<sup>7)</sup></b>	✓											
<b>Reverse polarity protection</b>	✓											
<b>Power-up pulse suppression</b>	✓											
Shock/vibration stress	30 g, 11 ms/10 ... 55 Hz											
Ambient temperature $T_a$	-40 ... +80 °C, +100 °C for 15 minutes											
<b>Housing material</b>	Stainless steel 316L/1.4404, PPS (FDA certified)											
Tightening torque	50 Nm											

1) At  $I_A$  max.

2) Without load

3) Of  $S_r$ 

4) According to EN 60529

5) According to EN 40050

6) Thread diameter x pitch (mm)

7) Pulsed

Order information	
Type	Order no.
IMF18-08BPSVCOS	6035476
IMF18-08BNSVCOS	6035477
IMF18-08BPOVCOS	6035478
IMF18-08BNOVCOS	6035479
IMF18-08BPPVCOS	6035227
IMF18-08BNPVCOS	6035228

	<b>Sensing range</b>
	<b>8 mm</b>
<b>Inductive sensor</b>	

- Robust stainless steel housing 316L/1.4404
- Enclosure rating IP 69K and IP 68
- Extended temperature range -40 °C ... +80 °C, +100 °C for 15 minutes

**Dimensional drawing**

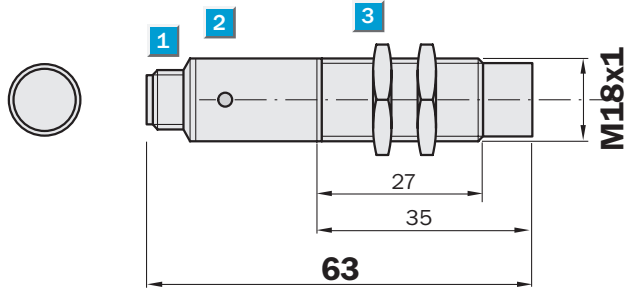

- 1** Connection
- 2** Display LED
- 3** Fastening nuts (2 x), width across 24, stainless steel (316L/1.4404)



**Connection type**

IMF18-08NNSVCOS	IMF18-08NNOVCOS	IMF18-08NNPVCOS
IMF18-08NPSVCOS	IMF18-08NPOVCOS	IMF18-08NPPVCOS

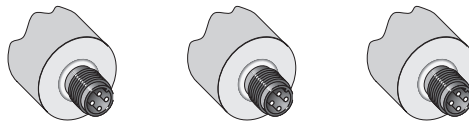

M12, 4-pin

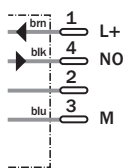

M12, 4-pin

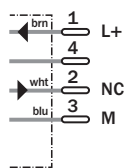

M12, 4-pin

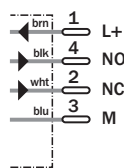

<b>Accessories</b>
Mounting systems
Stainless steel 316L/1.4404
Connecting cables
"Food & Beverage", M12, 4-pin
Extension cables
"Food & Beverage", M12, 4-pin
Sensor splitter-box
"Food & Beverage"



Technical data		IMF18	08NPS VCOS	08NNS VCOS	08NPO VCOS	08NNO VCOS	08NPP VCOS	08NNP VCOS				
<b>Sensing range <math>S_n</math></b>	8 mm											
<b>Electrical configuration</b>	DC 3-wire											
	DC 4-wire											
	10 ... 30 V DC											
Ripple $V_{pp}$	$\leq 10 \%$											
Voltage drop $U_d$	$\leq 2 V^{1)}$											
Power consumption	$\leq 15 mA^{2)}$											
<b>Continuous current <math>I_A</math></b>	$\leq 200 mA$											
Time delay before availability $t_v$	Approx. 50 ms											
Hysteresis H, of $s_r$	1 ... 20 %											
Repeatability R	5 % ( $V_S$ and $T_a$ constant) <sup>3)</sup>											
Temperature drift, of $S_r$	10 %											
EMC	According to EN 60947-5-2											
<b>Switching output</b>	PNP											
	NPN											
<b>Output function</b>	Normally open											
	Normally closed											
	Complementary											
<b>Installation</b>	Non-flush											
<b>Connection type</b>	Connector M12, 4-pin, gold-plated											
<b>Enclosure rating</b>	IP 68 <sup>4)</sup> , IP 69K <sup>5)</sup>											
Max. switching frequency	1,700 Hz											
Dimensions	M18x1 <sup>6)</sup>											
<b>Short-circuit protection<sup>7)</sup></b>	✓											
<b>Reverse polarity protection</b>	✓											
<b>Power-up pulse suppression</b>	✓											
Shock/vibration stress	30 g, 11 ms/10 ... 55 Hz											
Ambient temperature $T_a$	-40 ... +80 °C, +100 °C for 15 minutes											
<b>Housing material</b>	Stainless steel 316L/1.4404, PPS (FDA certified)											
Tightening torque	50 Nm											

1) At  $I_A$  max.

2) Without load

3) Of  $S_r$ 

4) According to EN 60529

5) According to EN 40050

6) Thread diameter x pitch (mm)

7) Pulsed

Order information	
Type	Order no.
IMF18-08NPSVCOS	6035472
IMF18-08NNSVCOS	6035473
IMF18-08NPOVCOS	6035474
IMF18-08NNOVCOS	6035475
IMF18-08NPPVCOS	6035225
IMF18-08NNPVCOS	6035226

**Sensing range**  
**12 mm**

Inductive sensor

- Robust stainless steel housing 316L/1.4404
- Enclosure rating IP 69K and IP 68
- Extended temperature range  
-40 °C ... +80 °C,  
+100 °C for 15 minutes

Dimensional drawing

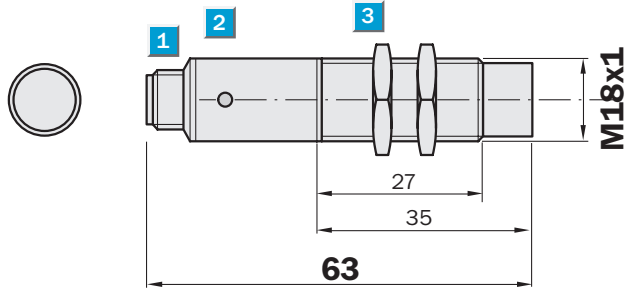

- 1 Connection
- 2 Display LED
- 3 Fastening nuts (2 x), width across 24, stainless steel (316L/1.4404)



Connection type

IMF18-12NNSVCOS	IMF18-12NNOVCOS	IMF18-12NNPVCOS
IMF18-12NPSVCOS	IMF18-12NPOVCOS	IMF18-12NPPVCOS

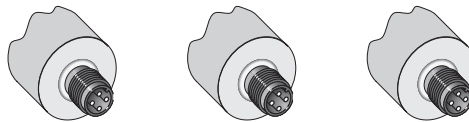

M12, 4-pin

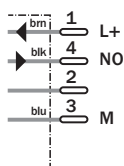

M12, 4-pin

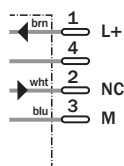

M12, 4-pin

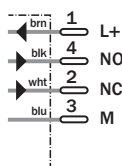

Accessories

Mounting systems
Stainless steel 316L/1.4404
Connecting cables
"Food & Beverage", M12, 4-pin
Extension cables
"Food & Beverage", M12, 4-pin
Sensor splitter-box
"Food & Beverage"

Technical data		IMF18	12NPS VCOS	12NNS VCOS	12NPO VCOS	12NNO VCOS	12NPP VCOS	12NNP VCOS				
<b>Sensing range <math>S_n</math></b>	12 mm											
<b>Electrical configuration</b>	DC 3-wire											
	DC 4-wire											
	10 ... 30 V DC											
Ripple $V_{pp}$	$\leq 10 \%$											
Voltage drop $U_d$	$\leq 2 V^{1)}$											
Power consumption	$\leq 15 mA^{2)}$											
<b>Continuous current <math>I_A</math></b>	$\leq 200 mA$											
Time delay before availability $t_v$	Approx. 50 ms											
Hysteresis H, of $s_r$	1 ... 20 %											
Repeatability R	5 % ( $V_S$ and $T_a$ constant) <sup>3)</sup>											
Temperature drift, of $S_r$	10 %											
EMC	According to EN 60947-5-2											
<b>Switching output</b>	PNP											
	NPN											
<b>Output function</b>	Normally open											
	Normally closed											
	Complementary											
<b>Installation</b>	Non-flush											
<b>Connection type</b>	Connector M12, 4-pin, gold-plated											
<b>Enclosure rating</b>	IP 68 <sup>4)</sup> , IP 69K <sup>5)</sup>											
Max. switching frequency	1,700 Hz											
Dimensions	M18x1 <sup>6)</sup>											
<b>Short-circuit protection<sup>7)</sup></b>	✓											
<b>Reverse polarity protection</b>	✓											
<b>Power-up pulse suppression</b>	✓											
Shock/vibration stress	30 g, 11 ms/10 ... 55 Hz											
Ambient temperature $T_a$	-40 ... +80 °C, +100 °C for 15 minutes											
<b>Housing material</b>	Stainless steel 316L/1.4404, PPS (FDA certified)											
Tightening torque	50 Nm											

1) At  $I_A$  max.

2) Without load

3) Of  $S_r$ 

4) According to EN 60529

5) According to EN 40050

6) Thread diameter x pitch (mm)

7) Pulsed

Order information	
Type	Order no.
IMF18-12NPSVCOS	6035480
IMF18-12NNSVCOS	6035481
IMF18-12NPOVCOS	6035482
IMF18-12NNOVCOS	6035483
IMF18-12NPPVCOS	6035229
IMF18-12NNPVCOS	6035230

**Connecting cables  
"Food & Beverage"**

**Round connectors**

- Especially suitable for use in the "Food & Beverage" sector
- Gold plated pins
- Improved resistance to chemicals, acids and cleaning agents
- Enclosure rating IP 69K (only in fully locked position with its plugs)
- Stainless steel locking nut (V4A)

**Dimensional drawings**

DOL-1204...

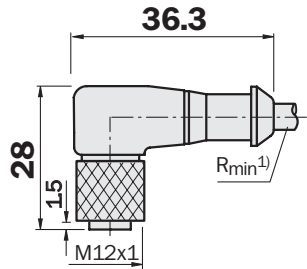
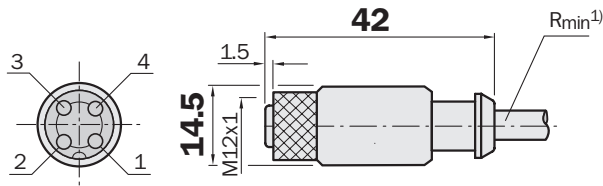

DOL-1204-L...

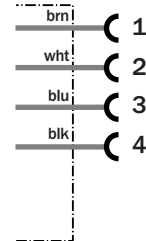
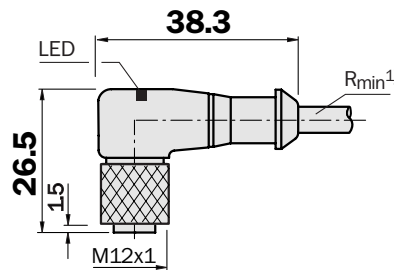

Contacts	Wire colour
1	brown
2	white
3	blue
4	black

<sup>1)</sup> Minimum bend radius in dynamic use  
R<sub>min</sub> = 20 x cable diameter



## Technical data

<b>Supply voltage <math>V_s</math></b>	250 V AC/300 V DC (M12, 4-pin connector)
	10 ... 30 V DC (M12, LED indicator)
<b>Contact resistance</b>	≤ 5 mΩ
<b>Nominal power</b>	4 A (CSA = 3 A)
<b>Test voltage</b>	2.0 kV eff./60 s. (4-pin)
<b>Insulation group</b>	C acc. VDE 0110
<b>Insulation resistance</b>	> 10 <sup>9</sup> Ω
<b>Temperature range</b>	In fixed position            -25 °C ... +90 °C
	In flexible motion            +5 °C ... +90 °C
<b>Bending radius</b>	> 10 x diameter of cable
<b>Contact</b>	CuZn, 0.3 μm gold plated
<b>Locking nut</b>	Stainless steel V4A
<b>Cable</b>	PVC, colour orange
<b>Conductor diameter</b>	4 x 0.25 mm <sup>2</sup>
<b>Connector</b>	PVC, colour orange
<b>Enclosure rating</b>	IP 69K (only in fully locked position with its plugs)
<b>Tightening torque</b>	0.5 Nm

## Order information

## Round connectors M12 connecting cable "Food &amp; Beverage"

Type	Order no.	Description	Contacts	Cable length [m]
DOL-1204-G02MN	6028128	Female connector    straight	4	2
DOL-1204-G05MN	6028130	Female connector    straight	4	5
DOL-1204-G10MN	6028132	Female connector    straight	4	10
DOL-1204-G25MN	6028134	Female connector    straight	4	25
DOL-1204-W02MN	6028129	Female connector    angled	4	2
DOL-1204-W05MN	6028131	Female connector    angled	4	5
DOL-1204-W10MN	6028133	Female connector    angled	4	10
DOL-1204-W25MN	6028135	Female connector    angled	4	25
DOL-1204-L02MN	6028136	Female connector    angled LED (PNP)	4	2
DOL-1204-L05MN	6028137	Female connector    angled LED (PNP)	4	5
DOL-1204-L10MN	6028138	Female connector    angled LED (PNP)	4	10
DOL-1204-L25MN	6028139	Female connector    angled LED (PNP)	4	25

**Extension cable  
"Food & Beverage"**

**Round connectors**

- Especially suitable for use in the "Food & Beverage" sector
- Gold plated pins
- Improved resistance to chemicals, acids and cleaning agents
- Enclosure rating IP 69K (only in fully locked position with its plugs)
- Stainless steel locking nut (V4A)

**Dimensional drawings**

DSL-1204-...

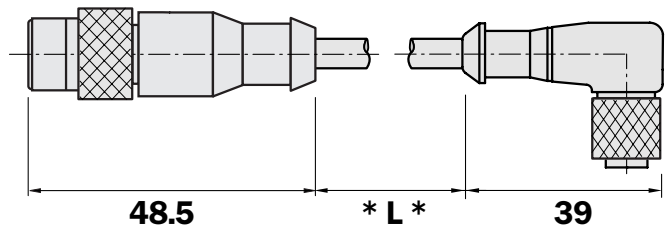
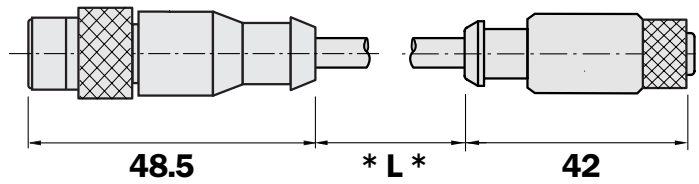
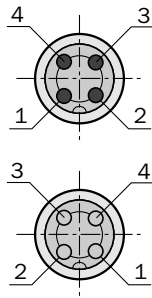

## Technical data

Supply voltage $V_s$	250 V AC/300 V DC	
Contact resistance	$\leq 5 \text{ m}\Omega$	
Nominal power	4 A (CSA = 3 A)	
Testvoltage	2.0 kV eff./60 s.	
Insulation group	C acc. VDE 0110	
Insulation resistance	$> 10^9 \Omega$	
Temperature range	In fixed position	-25 °C ... +90 °C
	In flexible motion	+5 °C ... +90 °C
Bending radius	$> 10 \times$ diameter of cable	
Contact	CuZn, 0.3 $\mu\text{m}$ gold plated	
Locking nut	Stainless steel (V4A)	
Cable	PVC, colour orange	
Conductor diameter	4 x 0.25 mm <sup>2</sup>	
Connector	PVC, colour orange	
Enclosure rating	IP 69K (only in fully locked position with its plugs)	
Tightening torque	0.5 Nm	

## Order information

## Round connectors extension cable "Food &amp; Beverage", female connector M12, male connector M12 (straight)

Type	Order no.	Description		Contacts	Contacts	Cable length [m]
				Female connector	Male connector	
DSL-1204-G0M6N	6028194	Female connector	straight	4	4	0.6
DSL-1204-G02MN	6028195	Female connector	straight	4	4	2
DSL-1204-G05MN	6028196	Female connector	straight	4	4	5
DSL-1204-B0M6N	6028197	Female connector	angled	4	4	0.6
DSL-1204-B02MN	6028198	Female connector	angled	4	4	2
DSL-1204-B05MN	6028199	Female connector	angled	4	4	5

**"Food & Beverage"  
IP 69K, V4A**

Sensor splitter-box

- Enclosure rating IP 69K (only in fully locked position with its plugs or dust covers)
- Housing & thread material: stainless steel V4A
- Especially suitable for use in the "Food & Beverage" sector
- Improved resistance to chemicals, acids and cleaning agents

Dimensional drawings

SNL-08...

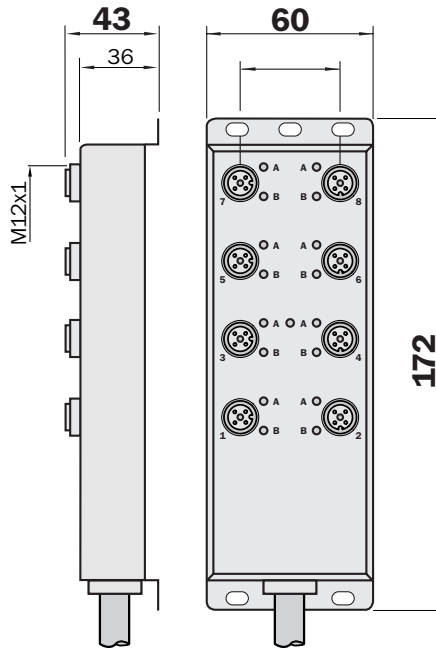

M12-Contacts	Wire colour	Signal/outlet
1	brown	+
3	blue	-
2	grey/pink	1
	red/blue	2
	white/green	3
	brown/green	4
	white/yellow	5
	yellow/brown	6
	white/grey	7
	grey/brown	8
4	white	1
	green	2
	yellow	3
	grey	4
	pink	5
	red	6
	black	7
	violet	8
5	green/yellow	PE



**Technical data**

<b>Temperature range</b>	0 °C ... +60 °C
<b>Materials</b>	
Housing	V4A-stainless steel
Moulded body	PVC
Contact	CuZn, pre-nickeled and 0.8 µm gold plated
Threaded sleeve	V4A-stainless steel
O-Ring	EPDM
<b>Mechanical data</b>	
Enclosure rating	IP 69K (only in fully locked position with its plugs)
Tightening torque	0.5 Nm
<b>Electrical data</b>	
Contact resistance	≤ 5 mΩ
Nominal power	4 A per outlet/11 A max. total at 30 °C (refer to correction factors EN 60204-1)
Supply voltage $V_s$	10 ... 30 V DC
Reference voltage	32 V ~ eff.
Insulation resistance	> 10 <sup>9</sup> Ω
Pollution grade	2 acc. VDE 0110
Cable	PVC, colour black, 3 x 1.0 mm <sup>2</sup> /16 x 0.5 mm <sup>2</sup> (appropriate for drag cable use)
<b>Accessories</b>	4 dust covers for unused sockets

**Order information**

**Sensor splitter-box "Food & Beverage", IP 69K, V4A (1.4404/316 L), M12 x 1 mm (5-pin), 8 x female connector, type of connection, cable**

Type	Order no.	Connecting cable		
		Length [m]	Lead [mm <sup>2</sup> ]	Cable
SNL-08D12-KA05	6027586	5	3 x 1.0/16 x 0.5	PVC black
SNL-08D12-KA10	6027587	10	3 x 1.0/16 x 0.5	PVC black
SNL-08D12-KA15	6027588	15	3 x 1.0/16 x 0.5	PVC black

## Dimensional drawings and order information

### Mounting bracket for IMF12, INOX 12

Type	Order no.
BEF-WN-M12N	5320949

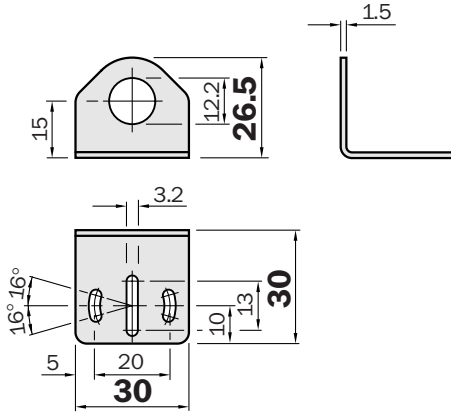

### Mounting bracket for IMF12

Type	Order no.
BEF-WG-M12N	5320950

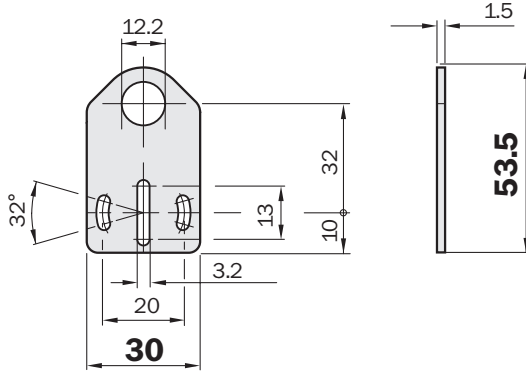

### Mounting bracket for IMF18, INOX 18

Type	Order no.
BEF-WN-M18N	5320947

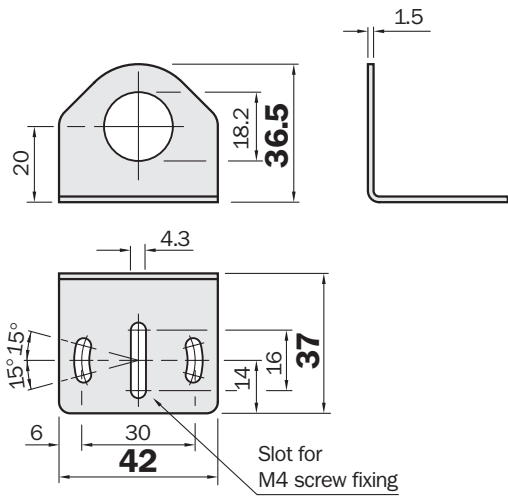

### Mounting bracket for IMF18

Type	Order no.
BEF-WG-M18N	5320948

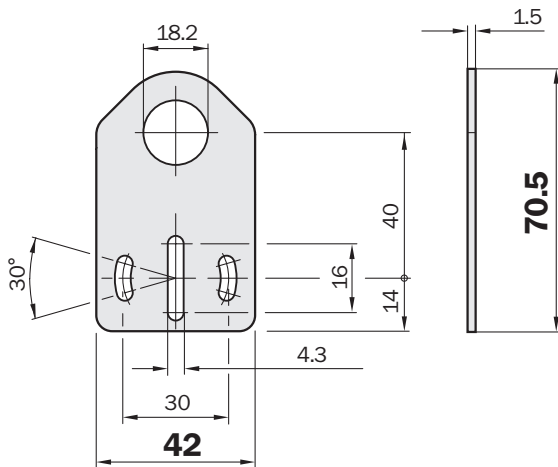



**Australia**

Phone +61 3 9497 4100  
1800 33 48 02 – tollfree  
E-Mail sales@sick.com.au

**Belgium/Luxembourg**

Phone +32 (0)2 466 55 66  
E-Mail info@sick.be

**Brasil**

Phone +55 11 3215-4900  
E-Mail sac@sick.com.br

**Ceská Republika**

Phone +420 2 57 91 18 50  
E-Mail sick@sick.cz

**China**

Phone +852-2763 6966  
E-Mail ghk@sick.com.hk

**Danmark**

Phone +45 45 82 64 00  
E-Mail sick@sick.dk

**Deutschland**

Phone +49 211 5301-250  
E-Mail info@sick.de

**España**

Phone +34 93 480 31 00  
E-Mail info@sick.es

**France**

Phone +33 1 64 62 35 00  
E-Mail info@sick.fr

**Great Britain**

Phone +44 (0)1727 831121  
E-Mail info@sick.co.uk

**India**

Phone +91-22-4033 8333  
E-Mail info@sick-india.com

**Israel**

Phone +972-4-999-0590  
E-Mail info@sick-sensors.com

**Italia**

Phone +39 02 27 43 41  
E-Mail info@sick.it

**Japan**

Phone +81 (0)3 3358 1341  
E-Mail support@sick.jp

**Nederlands**

Phone +31 (0)30 229 25 44  
E-Mail info@sick.nl

**Norge**

Phone +47 67 81 50 00  
E-Mail austefjord@sick.no

**Österreich**

Phone +43 (0)22 36 62 28 8-0  
E-Mail office@sick.at

**Polska**

Phone +48 22 837 40 50  
E-Mail info@sick.pl

**Republic of Korea**

Phone +82-2 786 6321/4  
E-Mail kang@sickkorea.net

**Republika Slovenija**

Phone +386 (0)1-47 69 990  
E-Mail office@sick.si

**România**

Phone +40 356 171 120  
E-Mail office@sick.ro

**Russia**

Phone +7 495 775 05 34  
E-Mail info@sick-automation.ru

**Schweiz**

Phone +41 41 619 29 39  
E-Mail contact@sick.ch

**Singapore**

Phone +65 6744 3732  
E-Mail admin@sicksgp.com.sg

**Suomi**

Phone +358-9-25 15 800  
E-Mail sick@sick.fi

**Sverige**

Phone +46 10 110 10 00  
E-Mail info@sick.se

**Taiwan**

Phone +886 2 2375-6288  
E-Mail sickgrc@ms6.hinet.net

**Türkiye**

Phone +90 216 587 74 00  
E-Mail info@sick.com.tr

**USA/Canada/México**

Phone +1(952) 941-6780  
1 800-325-7425 – tollfree  
E-Mail info@sickusa.com

More representatives and agencies  
in all major industrial nations at  
[www.sick.com](http://www.sick.com)