

UVB & UVC N3535 1 LEDiL Selector

ILR-Xx01-Sxxx-LEDIL-SC201.

Product Overview

At the heart of each UV LEDiL Selector is a compact, high quality and reliable TSLC N3535U 1-chip UV LED, with primary 60, 90 or 130 degree lens, featuring high radiometric power density and design flexibility. With a ceramic substrate, the N3535U is ideal for anti-bacterial and disinfection applications. The N3535U range is suited to demanding industrial applications and features a vertical chip structure on a patented metal alloy substrate, offering advances in optical output and high thermal conductivity. LEDiL Selectors are compact, powerful LED light sources built on aluminium substrates for optimal thermal management. Available with push-in connectors for easy installation.

Applications

- Polymer curing
- Ink curing
- Counterfeit detection
- Aquarium lighting
- Medical and DNA sequencing
- Inspection equipment
- Horticultural lighting
- Disinfection
- Water Sterilisation

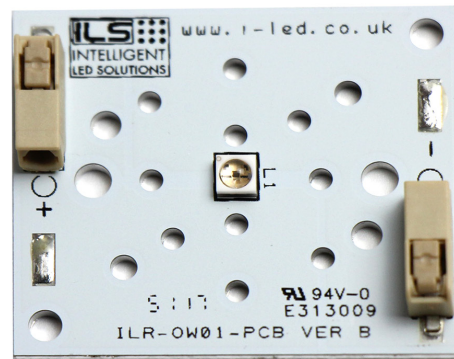

Technical Features

- N3535 1 LEDiL Selector contains a 1-chip UV LED with integral 60,90 or 130 degree silicone lens
- Mounting holes using M3 screws allows easy installation
- Suitable Heatsinks available – check options in Heatsink section
- Matching Power Supply available – check options in Power Supply section
- Suitable Thermal Interface Material available – check options in Thermal Interface Material section
- 60 Degree Size (L x W x H): 40 x 35 x 4.71 mm
- 90 Degree Size (L x W x H): 40 x 35 x 4.15 mm
- 130 Degree Size (L x W x H): 40 x 35 x 3.65mm
- LEDiL Selectors can be linked together to produce longer chains
- Current range to 100-350mA

*This datasheet should be read in conjunction with the relevant TSLC data for the LED used

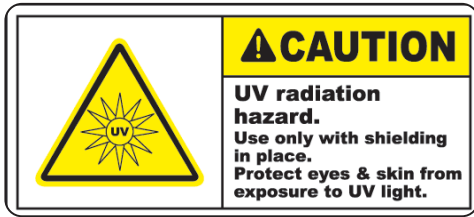

These products generate UVC radiation which can cause skin damage and conjunctivitis to humans and animals within a short time. The skin and eyes must be fully protected against exposure. You should be aware that UVC radiation does not eliminate harmful non-degradable substances such as heavy metals or pesticides. Assume IEC62471 Risk Group 3

Important Information and Precautions

- During operation, the LED emits ultraviolet (UV) light which is harmful to skin and eyes. UV radiation can cause sunburn, conjunctivitis and cancer.
- Precautions MUST be taken to avoid looking directly at the UV light such as the use of UV light protective glasses.
- If LEDs are embedded in devices, you must add warning labels to alert users of the safety precautions required when operating devices using UV LED lights. The module's LEDs, when powered up, are very powerful. Although the light may appear off, however UV is invisible to the human eye and can still damage eyes. Thus it is advised that you do not look directly at it. Turn the module away from you and do not shine into the eyes of others. The module's LEDs, when powered up, are very powerful. Although the light may appear off, however UV is invisible to the human eye and can still damage eyes. Thus it is advised that you do not look directly at it. Turn the module away from you and do not shine into the eyes of others
- These devices emit high intensity UV/NUV light. Necessary precautions must be taken during operation. Do not look directly into the light or look through the optical system when in operation. Protective eyewear should be worn at all times during operation.
- Lens discolouration may occur with prolonged exposure to UV/NUV light. Lens material will need to be tested for UV/NUV light compatibility and durability.
- LEDiL selectors will overheat in operation if not attached to a suitable Heatsink. Overheating can cause failure or irreparable damage.
- Do not operate LEDiL Selectors with a Power Supply with unlimited current.
- Connection to constant voltage Power Supplies that are not current limited may cause the LEDiL Selectors to consume current above the specified maximum and cause failure or irreparable damage.
- LEDiL Selectors, when operated, can reach high temperatures thus there is risk of injury if they are touched.
- DO NOT HOT PLUG ON LED SIDE OF POWER SUPPLY.
- DO NOT TOUCH or PUSH on the LED as this can cause irreparable damage.



Product Options

ILS PART NUMBER	Peak Wavelength*		Typical Wattage at 350mA§	Forward Voltage*	Minimum Radiometric Power (mW) at 350mA*	Radiance Angle	Relevant TSLC LED data
	min λp	max λp					
ILR-XN01-S260-LEDIL-SC201.	260nm	270nm	2.28W	5.0V to 7.5V	25mW	60° (+/- 30°)	N3535U
ILR-XN01-S270-LEDIL-SC201.	270nm	290nm	2.28W	5.0V to 7.5V	40mW	60° (+/- 30°)	N3535U
ILR-XN01-S300-LEDIL-SC201.	300nm	320nm	2.28W	5.0V to 7.5V	60mW	60° (+/- 30°)	N3535U
ILR-XO01-S260-LEDIL-SC201.	260nm	270nm	2.28W	5.0V to 7.5V	25mW	90° (+/- 45°)	N3535U
ILR-XO01-S270-LEDIL-SC201.	270nm	290nm	2.28W	5.0V to 7.5V	40mW	90° (+/- 45°)	N3535U
ILR-XO01-S300-LEDIL-SC201.	300nm	320nm	2.28W	5.0V to 7.5V	60mW	90° (+/- 45°)	N3535U
ILR-XP01-S260-LEDIL-SC201.	260nm	270nm	2.28W	5.0V to 7.5V	25mW	130° (+/- 65°)	N3535U
ILR-XP01-S270-LEDIL-SC201.	270nm	290nm	2.28W	5.0V to 7.5V	40mW	130° (+/- 65°)	N3535U
ILR-XP01-S300-LEDIL-SC201.	300nm	320nm	2.28W	5.0V to 7.5V	60mW	130° (+/- 65°)	N3535U

*Radiometric power is measured with an accuracy of ±10%.

*The forward voltage is measured with an accuracy of ±0.2V

*The peak/dominant wavelength is measured with an accuracy of ±1nm

Minimum and Maximum Ratings

ILS Part Number	Operating Temperature at Tc-Point [°C]*	Storage Temperature [°C]*	Forward Current per chip	Reverse Voltage [Vdc]*
ILR-XN01-S260-LEDIL-SC201.	-40 ... 60 (°C)	-40 ... 105 (°C)	350mA max	Not designed to be driven in reverse
ILR-XN01-S270-LEDIL-SC201.	-40 ... 60 (°C)	-40 ... 105 (°C)	350mA max	Not designed to be driven in reverse
ILR-XN01-S300-LEDIL-SC201.	-40 ... 60 (°C)	-40 ... 105 (°C)	350mA max	Not designed to be driven in reverse
ILR-XO01-S260-LEDIL-SC201.	-40 ... 60 (°C)	-40 ... 105 (°C)	350mA max	Not designed to be driven in reverse
ILR-XO01-S270-LEDIL-SC201.	-40 ... 60 (°C)	-40 ... 105 (°C)	350mA max	Not designed to be driven in reverse
ILR-XO01-S300-LEDIL-SC201.	-40 ... 60 (°C)	-40 ... 105 (°C)	350mA max	Not designed to be driven in reverse
ILR-XP01-S260-LEDIL-SC201.	-40 ... 60 (°C)	-40 ... 105 (°C)	350mA max	Not designed to be driven in reverse
ILR-XP01-S270-LEDIL-SC201.	-40 ... 60 (°C)	-40 ... 105 (°C)	350mA max	Not designed to be driven in reverse
ILR-XP01-S300-LEDIL-SC201.	-40 ... 60 (°C)	-40 ... 105 (°C)	350mA max	Not designed to be driven in reverse

* Exceeding maximum ratings for operating and storage temperature will reduce expected life time or destroy the LED module. Exceeding maximum ratings for operating voltage will cause hazardous overload and is likely to destroy the LED module. The temperature of the LED module must be measured at the Tc-Point according to EN60598-1 in a thermally constant status with a temperature sensor or a temperature sensitive label.



Radiation of single LED

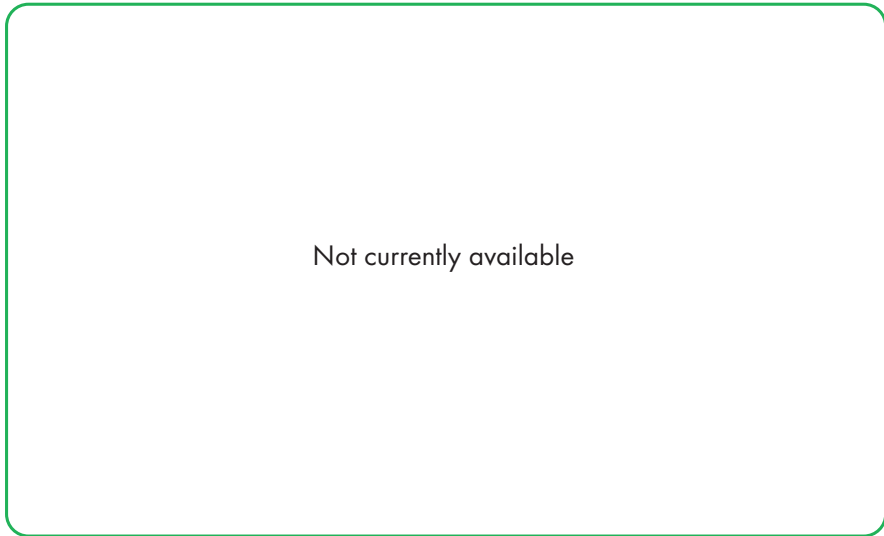

Technical Drawing (mm)

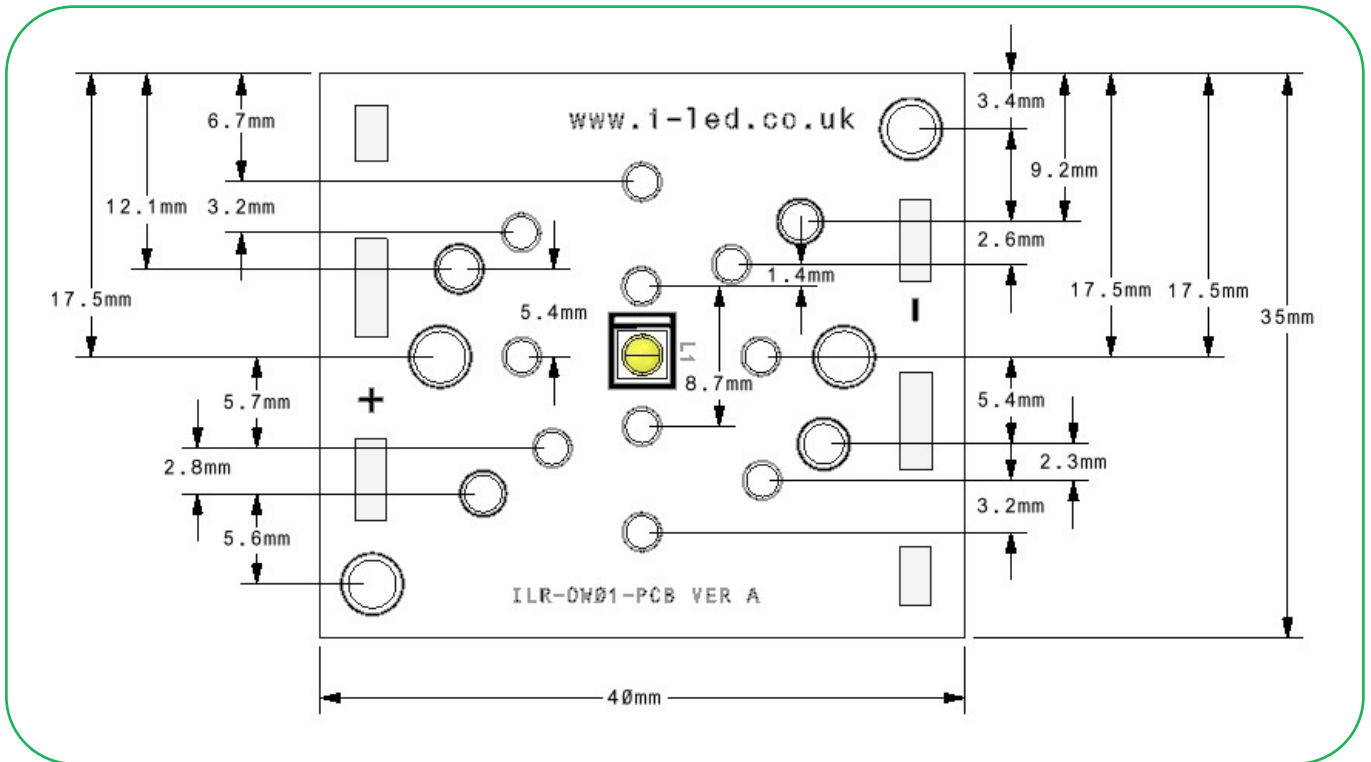

3D drawing files are available on request from ILS. Please call or email



N3535 1 LEDiL Selector Lens and Reflector Options

LEDiL precision-engineered Lenses and Reflectors allow for rapid deployment of all types of light fixtures, including street lights, wall-wash, high-bay, sconces, emergency beacons, parking garage/low-bay, MR and AR downlights, and dock lights. Precision-engineered for maximum efficiency and durability, LEDiL Lenses and Reflectors are released alongside the latest product releases from our LED suppliers. You select the best LED for the application; choose LEDiL and you're selecting the best optical solution as well.



Part Number	Beam	Size	Height	Family	FWHM	Material	Colour	Fastening
F14531_JENNY-CY	Batwing	35x35mm	11.5mm	JENNY	105+105	Silicone	Clear	Tape Holder
FCA14961_G2-NIS033U-W-PIN	Wide	22x22mm	12.9mm	ROSE	45	Silicone	Black	Tape and Pin
FCA14011_G2-NIS033U-S	Spot	22x22mm	12.9mm	ROSE	20	Silicone	Black	Tape
FCA14405_G2-NS033U-M	Medium	22x22mm	12.9mm	ROSE	25	Silicone	Black	Tape
FCA14464_G2-NIS033U-W	Wide	22x22mm	12.9mm	ROSE	45	Silicone	Black	Tape
FCA14962_G2-NIS033U-M-PIN	Medium	22x22mm	12.9mm	ROSE	25	Silicone	Black	Tape and Pin
FCA14963_G2-NIS033U-S-PIN	Spot	22x22mm	12.9mm	ROSE	20	Silicone	Black	Tape and Pin
FCA150007_G2-ROSE-UV-SS	Smooth Spot	22x22mm	12.9mm	ROSE	15	Silicone	Black	Tape
FCA15008_G2-ROSE-UV-M	Medium	22x22mm	12.9mm	ROSE	25	Silicone	Black	Tape
FCA15009_G2-ROSE-UV-W	Wide	22x22mm	12.9mm	ROSE	40	Silicone	Black	Tape

N3535 1 LEDiL Selector Heatsink Options

ILS has a series of Aluminium Alloy Heatsinks to be used with our standard range of PowerStars, PowerClusters and PowerLinear Engines. Some Heatsinks are supplied as kits with fixing screws and Thermal Interface Material (TIM). ILS is continually expanding its Heatsink range and we are equally happy to manufacture custom Heatsinks upon your request.

ILS Product		No Heatsink, in free air	ILA-HSINK-78X46X25MM
N35351 LEDiL Selector	350mA		



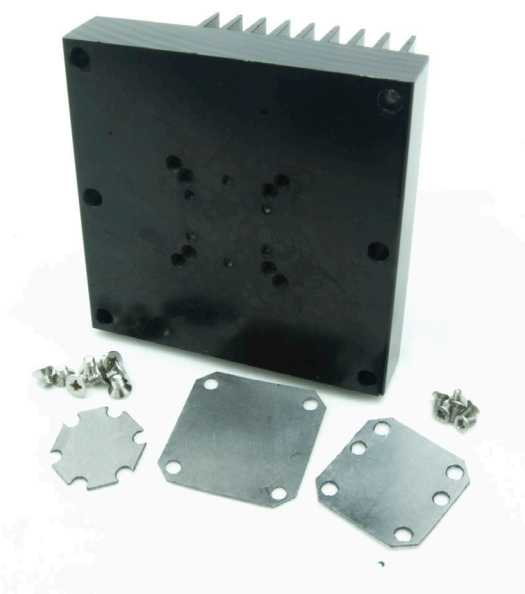

Key

- Operates under the recommended ILS junction temperature
- Operates under the recommended LED maximum junction temperature
- Not suitable for use
- Heatsink not designed for use with this product



N3535 1 LEDiL Selector Power Supply Options

ILS has a comprehensive range of standard Power Supplies. Additional Power Supplies are frequently being introduced so please call us or check our website for the latest offering.

ILS Driver Part No.	Rating	Current	N3535 1 LEDiL Selectors per driver	
IZC035-004F-4065C-SAL	4W	350mA	1	
IZC035-008F-5065C-SA	8W	350mA	1-4	
IZC035-017F-0067A-SA	17W	350mA	2-6	
IZC035-018T-9500A-SX	18W	350mA	3-6	
OT-FIT-15/220-240/500-LT2-LP	15W	150-500mA	3-6	
OTE-13/220-240/350-PC	13W	350mA	4-5	
OTi-DALI-15/220-240/1A0-LT2	15W	150-1050mA	2-7	
OTi-DALI-25/220-240/700-LT2	25W	180-700mA	3-7	
OTi-DALI-10/220-240/700-NFC	10W	150-700mA	1-6	
OTi-DALI-15/220...240/1A0-LT2-NFC	15W	150-1050mA	2-7	
OTi-DX-25/220-240/700-NFC	25W	180-700mA	3-6	
OTi-30/120-277/1A0-DX-L	30W	150-1050mA	2-7	
OT-20/170-240/1A0-1DIMLT2-G1-CE	20W	200-1050mA	2-5	

N3535 1 LEDiL Selector Thermal Interface Material Options

ILS has produced a range of high-performance, cost effective Thermal Interface Materials to match perfectly their standard products. Our product fills the air pockets between the two surfaces, forming a continuous layer to conduct heat away from the LED to the Heatsink.

Product	Non Adhesive	Single Sided Adhesive	Double Sided Adhesive
N3535 1 LEDiL Selector	ILA-TIM-LEDIL-40x35-0A	ILA-TIM-LEDIL-40x35-1A	ILA-TIM-LEDIL-40x35-2A

Other sizes are available, including customised parts.



Assembly Information

- The mounting of the LEDiL Selector has to be on a metal Heatsink.
- In order to optimise the thermal management, the metal surface needs to be clean (dirt and oil free) and planar for the best contact with the LED module. A thermal grease or heat transfer material is highly recommended.

Safety Information

- The LED module itself and all its components must not be mechanically stressed.
- Assembly must not damage or destroy conducting paths on the circuit board.
- The mounting of the module is carried out by attaching it to the mounting holes. Metal mounting screws must be insulated with synthetic washers to prevent circuit board damage and possible short circuiting.
- To avoid mechanical damage to the connecting cables, the boards should be attached securely to the intended substrate. Heavy vibration should be avoided.
- Observe correct polarity! Depending on the product, incorrect polarity will lead to emission of red or no light. The module can be destroyed!
- Pay attention to standard ESD precautions when installing the LEDiL Selector.
- The LEDiL Selector, as manufactured, has no conformal coating and therefore offers no inherent protection against corrosion.
- Damage by corrosion will not be accepted as a materials defect claim. It is the user's responsibility to provide suitable protection against corrosive agents such as moisture and condensation and other harmful elements.
- For outdoor usage, a housing is definitely required to protect the board against environmental influences. The design of the housing must correspond to the IP standards in the application. It is also the responsibility of the user to ensure any housings or modifications keep the Tc junction temperature to within stated ranges.
- To also ease the luminaire/installation approval, electronic control gear for LED or LED modules should carry the CE mark and be ENEC certified. In Europe the declarations of conformity must include the following standards: CE: EC 61374-2-13, EN 55015, IEC 61547 and IEC 61000-3-2 - ENEC: 61374-2-13 and IEC/EN 62384.
- The evaluation of eye safety occurs according to the standard IEC 62471:2006 ("photobiological safety of lamps and lamp systems"). Within the risk grouping system of this CIE standard, the LED specified in this data sheet falls into the class "moderate risk" (exposure time 0.25s). Under real circumstances (for exposure time, eye pupils, observation distance), it is assumed that no endangerment to the eye exists from these devices. As a matter of principle, however, it should be mentioned that intense light sources have a high secondary exposure potential due to their blinding effect. As is also true when viewing other bright light sources (e.g. headlights), temporary reduction in visual acuity and afterimages can occur, leading to irritation, annoyance, visual impairment and even accidents, depending on the situation.

For further information please contact ILS

The values contained in this datasheet can change due to technical innovations. Any such changes will be made without separate notification.

