

For the electronic measurement of current: DC, AC, pulsed..., with galvanic separation between the primary and the secondary circuit.



Features

- Open loop multi-range current transducer
- Voltage output
- Single power supply +5 V
- Overcurrent detection $2.93 \times I_{PN}$ (peak value)
- EEPROM Control
- Galvanic separation between primary and secondary circuit
- Low power consumption
- Compact design for THT PCB mounting
- Aperture: 15 × 8 mm
- Factory calibrated
- **Dedicated parameter settings available on request (see page 12).**

Advantages

- Low offset drift
- Over-drivable U_{ref}
- 8 mm creepage/clearance
- Fast delay time.

Applications

- AC variable speed and servo motor drives
- Static converters for DC motor drives
- Battery supplied applications
- Uninterruptible Power Supplies (UPS)
- Switched Mode Power Supplies (SMPS)
- Power supplies for welding applications
- Combiner box
- MPPT.

Standards

- IEC 61800-1: 1997
- IEC 61800-2: 2015
- IEC 61800-3: 2004
- IEC 61800-5-1: 2007
- IEC 62109-1: 2010
- UL 508: 2013.

Application Domain

- Industrial.

Absolute maximum ratings

Parameter	Symbol	Unit	Value
Maximum supply voltage (not destructive)	$U_{C\ max}$	V	8
Maximum supply voltage (not entering non standard modes)	$U_{C\ max}$	V	6.5
Maximum primary conductor temperature	$T_{B\ max}$	°C	120
Maximum Electrostatic discharge voltage	U_{ESD}	kV	2

Stresses above these ratings may cause permanent damage. Exposure to absolute maximum ratings for extended periods may degrade reliability.

UL 508: Ratings and assumptions of certification

File # E189713 Volume: 2 Section: 5

Standards

- CSA C22.2 NO. 14-10 INDUSTRIAL CONTROL EQUIPMENT - Edition 12
- UL 508 STANDARD FOR INDUSTRIAL CONTROL EQUIPMENT - Edition 17

Ratings

Parameter	Symbol	Unit	Value
Primary involved potential		V AC/DC	600
Max surrounding air temperature	T_A	°C	105
Primary current	I_P	A	According to series primary current
Secondary supply voltage	U_C	V DC	5
Output voltage	U_{out}	V	0 to 5

Conditions of acceptability

- 1 - These devices have been evaluated for overvoltage category III and for use in pollution degree 2 environment.
- 2 - A suitable enclosure shall be provided in the end-use application.
- 3 - The terminals have not been evaluated for field wiring.
- 4 - These devices are intended to be mounted on a printed wiring board of end use equipment. The suitability of the connections (including spacings) shall be determined in the end-use application.
- 5 - Primary terminals shall not be straightened since assembly of housing case depends upon bending of the terminals.
- 6 - Any surface of polymeric housing have not been evaluated as insulating barrier.
- 7 - Low voltage control circuit shall be supplied by an isolating source (such as a transformer, optical isolator, limiting impedance or electro-mechanical relay).
- 10 - The jumper installed within the primary hole is only intended for fixing the sensor and not for carrying the primary current.

Marking

Only those products bearing the UR Mark should be considered to be Listed or Recognized and covered under UL's Follow-Up Service. Always look for the Mark on the product.

Insulation coordination

Parameter	Symbol	Unit	Value	Comment
RMS voltage for AC insulation test 50/60 Hz/1 min	U_d	kV	4.3	
Impulse withstand voltage 1.2/50 μ s	U_{Ni}	kV	8	
Partial discharge RMS test voltage (adjusted $q_m < 10$ pC)	U_t	V	1500	Busbar/secondary, jumpers/secondary
Clearance (pri. - sec.)	d_{Cl}	mm	> 8	Shortest distance through air
Creepage distance (pri. - sec.)	d_{Cp}	mm	> 8	Shortest path along device body
Clearance (pri. - sec.)	-	mm	> 8	When mounted on PCB with recommended layout
Case material	-	-	V0	according to UL 94
Comparative tracking index	CTI		600	
Application example	-	V	600	Reinforced insulation according to IEC 61800-5-1, CAT III, PD2
Application example	-	V	1000	Basic insulation according to IEC 61800-5-1, CAT III, PD2

Environmental and mechanical characteristics

Parameter	Symbol	Unit	Min	Typ	Max	Comment
Ambient operating temperature	T_A	°C	-40		105	
Ambient storage temperature	T_{ASt}	°C	-40		105	
Mass	m	g		34		

Electrical data HO 60-P-0100

 At $T_A = 25\text{ °C}$, $U_C = +5\text{ V}$, $R_L = 10\text{ k}\Omega$ unless otherwise noted (see Min, Max, typ. definition paragraph in page 14).

Parameter	Symbol	Unit	Min	Typ	Max	Comment
Primary nominal RMS current	I_{PN}	A		60		
Primary current, measuring range	I_{PM}	A	-150		150	@ $U_C \geq 4.6\text{ V}$
Number of primary turns	N_p	-		1		See application information
Supply voltage ¹⁾	U_C	V	4.5	5	5.5	
Current consumption	I_C	mA		19	25	
Reference voltage (output)	U_{ref}	V	2.48	2.5	2.52	Internal reference
Reference voltage (input)	U_{ref}	V	0.5		2.65	External reference
Output voltage range @ I_{PM}	$U_{out} - U_{ref}$	V	-2		2	Over operating temperature range
U_{ref} output resistance	R_{ref}	Ω	130	200	300	Series
U_{out} output resistance	R_{out}	Ω		2	5	Series
Load capacitance	C_L	nF	0		6	
OCD output on resistance	$R_{on\text{OCD}}$	Ω	70	95	150	Open drain, active low. Over operating temperature range
OCD output hold time	$t_{hold\text{OCD}}$	ms	0.7	1	1.4	Additional time after threshold has released
EEPROM control	U_{out}	mV	0		50	U_{out} forced to GND when EEPROM in an error state ²⁾
Electrical offset voltage @ $I_p = 0\text{ A}$	U_{OE}	mV	-5		5	$U_{out} - U_{ref}$ @ $U_{ref} = 2.5\text{ V}$
Electrical offset current referred to primary	I_{OE}	A	-0.375		0.375	
Temperature coefficient of U_{ref}	TCU_{ref}	ppm/K	-170		170	-40 °C ... 105 °C
Temperature coefficient of U_{OE}	TCU_{OE}	mV/K	-0.075		0.075	-40 °C ... 105 °C
Offset drift referred to primary @ $I_p = 0\text{ A}$	TCI_{OE}	mA/K	-5.625		5.625	-40 °C ... 105 °C
External detection threshold sensitivity	S_{th}	mV/A		13.333		800 mV @ I_{PN}
Sensitivity error @ I_{PN}	ϵ_S	%	-0.5		0.5	Factory adjustment (straight bus-bar)
Temperature coefficient of S	TCS	ppm/K	-350		350	-40 °C ... 105 °C
Linearity error 0 ... I_{PN}	ϵ_L	% of I_{PN}	-0.75		0.75	
Linearity error 0 ... I_{PM}	ϵ_L	% of I_{PM}	-0.5		0.5	
Magnetic offset current (@ $10 \times I_{PN}$) referred to primary	I_{OM}	A	-0.92		0.92	One turn
Delay time to 10 % of the final output value for I_{PN} step	t_{D10}	μs			2.5	@ 50 A/ μs
Delay time to 90 % of the final output value for I_{PN} step	t_{D90}	μs			3.5	@ 50 A/ μs
Frequency bandwidth (-3 dB)	BW	kHz		100		Small signals
Noise voltage spectral density (100 Hz ... 100 kHz)	u_{no}	$\mu\text{V}/\sqrt{\text{Hz}}$			9.2	
RMS noise voltage (DC ... 10 kHz) (DC ... 100 kHz) (DC ... 1 MHz)	U_{no}	mVpp		5.0 13.8 26.0		
Primary current, detection threshold	I_{PTh}	A	$2.64 \times I_{PN}$	$2.93 \times I_{PN}$	$3.22 \times I_{PN}$	Peak value $\pm 10\%$, overcurrent detection OCD
Sum of sensitivity and linearity @ I_{PN}	ϵ_{SL}	% of I_{PN}	-1.25		1.25	
Sum of sensitivity and linearity @ I_{PN} @ $T_A = +105\text{ °C}$	ϵ_{SL105}	% of I_{PN}	-4.80		4.80	See formula note ³⁾
Sum of sensitivity and linearity @ I_{PN} @ $T_A = +85\text{ °C}$	ϵ_{SL85}	% of I_{PN}	-3.91		3.91	See formula note ³⁾

 Notes: ¹⁾ 3.3 V SP version available

²⁾ EEPROM in an error state makes the transducer behave like a reverse current saturation. Use of the OCD may help to differentiate the two cases

³⁾

$$\epsilon_{SL}(T_A) = \epsilon_{SL25} + \left(TCS + \frac{TCI_{OE}}{I_{PN}} \right) \times |T_A - 25|$$

Electrical data HO 100-P-0100

 At $T_A = 25\text{ °C}$, $U_C = +5\text{ V}$, $R_L = 10\text{ k}\Omega$ unless otherwise noted (see Min, Max, typ. definition paragraph in page 14).

Parameter	Symbol	Unit	Min	Typ	Max	Comment
Primary nominal RMS current	I_{PN}	A		100		
Primary current, measuring range	I_{PM}	A	-250		250	@ $U_C \geq 4.6\text{ V}$
Number of primary turns	N_p	-		1		See application information
Supply voltage ¹⁾	U_C	V	4.5	5	5.5	
Current consumption	I_C	mA		19	25	
Reference voltage (output)	U_{ref}	V	2.48	2.5	2.52	Internal reference
Reference voltage (input)	U_{ref}	V	0.5		2.65	External reference
Output voltage range @ I_{PM}	$U_{out} - U_{ref}$	V	-2		2	Over operating temperature range
U_{ref} output resistance	R_{ref}	Ω	130	200	300	Series
U_{out} output resistance	R_{out}	Ω		2	5	Series
Load capacitance	C_L	nF	0		6	
OCD output on resistance	$R_{on\text{OCD}}$	Ω	70	95	150	Open drain, active low Over operating temperature range
OCD output hold time	$t_{hold\text{OCD}}$	ms	0.7	1	1.4	Additional time after threshold has released
EEPROM control	U_{out}	mV	0		50	U_{out} forced to GND when EEPROM in an error state ²⁾
Electrical offset voltage @ $I_P = 0\text{ A}$	U_{OE}	mV	-5		5	$U_{out} - U_{ref}$ @ $U_{ref} = 2.5\text{ V}$
Electrical offset current referred to primary	I_{OE}	A	-0.625		0.625	
Temperature coefficient of U_{ref}	TCU_{ref}	ppm/K	-170		170	-40 °C ... 105 °C
Temperature coefficient of U_{OE}	TCU_{OE}	mV/K	-0.075		0.075	-40 °C ... 105 °C
Offset drift referred to primary @ $I_P = 0\text{ A}$	TCI_{OE}	mA/K	-9.375		9.375	-40 °C ... 105 °C
External detection threshold sensitivity	S_{th}	mV/A		8		800 mV @ I_{PN}
Sensitivity error @ I_{PN}	ε_S	%	-0.5		0.5	Factory adjustment (straight bus bar)
Temperature coefficient of S	TCS	ppm/K	-350		350	-40 °C ... 105 °C
Linearity error 0 ... I_{PN}	ε_L	% of I_{PN}	-0.5		0.5	
Linearity error 0 ... I_{PM}	ε_L	% of I_{PM}	-0.5		0.5	
Magnetic offset current (@ $10 \times I_{PN}$) referred to primary	I_{OM}	A	-0.92		0.92	One turn
Delay time to 10 % of the final output value for I_{PN} step	t_{D10}	μs			2.5	@ 50 A/ μs
Delay time to 90 % of the final output value for I_{PN} step	t_{D90}	μs			3.5	@ 50 A/ μs
Frequency bandwidth (-3 dB)	BW	kHz		100		Small signals
Noise voltage spectral density (100 Hz ... 100 kHz)	u_{no}	$\mu\text{V}/\sqrt{\text{Hz}}$			6	
RMS noise voltage (DC ... 10 kHz) (DC ... 100 kHz) (DC ... 1 MHz)	U_{no}	mVpp		3.6 8.7 16.9		
Primary current, detection threshold	I_{PTh}	A	$2.64 \times I_{PN}$	$2.93 \times I_{PN}$	$3.22 \times I_{PN}$	Peak value $\pm 10\%$, overcurrent detection OCD
Sum of sensitivity and linearity @ I_{PN}	ε_{SL}	% of I_{PN}	-1		1	
Sum of sensitivity and linearity @ I_{PN} @ $T_A = +105\text{ °C}$	ε_{SL105}	% of I_{PN}	-4.55		4.55	See formula note ³⁾
Sum of sensitivity and linearity @ I_{PN} @ $T_A = +85\text{ °C}$	ε_{SL85}	% of I_{PN}	-3.66		3.66	See formula note ³⁾

Notes: ¹⁾ 3.3 V SP version available

²⁾ EEPROM in an error state makes the transducer behave like a reverse current saturation. Use of the OCD may help to differentiate the two cases

³⁾

$$\varepsilon_{SL}(T_A) = \varepsilon_{SL25} + \left(TCS + \frac{TCI_{OE}}{I_{PN}} \right) \times |T_A - 25|$$

Electrical data HO 120-P-0100

 At $T_A = 25\text{ °C}$, $U_C = +5\text{ V}$, $R_L = 10\text{ k}\Omega$ unless otherwise noted (see Min, Max, typ. definition paragraph in page 14).

Parameter	Symbol	Unit	Min	Typ	Max	Comment
Primary nominal RMS current	I_{PN}	A		120		
Primary current, measuring range	I_{PM}	A	-300		300	@ $U_C \geq 4.6\text{ V}$
Number of primary turns	N_P	-		1		See application information
Supply voltage ¹⁾	U_C	V	4.5	5	5.5	
Current consumption	I_C	mA		19	25	
Reference voltage (output)	U_{ref}	V	2.48	2.5	2.52	Internal reference
Reference voltage (input)	U_{ref}	V	0.5		2.65	External reference
Output voltage range @ I_{PM}	$U_{out} - U_{ref}$	V	-2		2	Over operating temperature range
U_{ref} output resistance	R_{ref}	Ω	130	200	300	Series
U_{out} output resistance	R_{out}	Ω		2	5	Series
Load capacitance	C_L	nF	0		6	
OCD output on resistance	$R_{on\text{OCD}}$	Ω	70	95	150	Open drain, active low Over operating temperature range
OCD output hold time	$t_{hold\text{OCD}}$	ms	0.7	1	1.4	Additional time after threshold has released
EEPROM control	U_{out}	mV	0		50	U_{out} forced to GND when EEPROM in an error state ²⁾
Electrical offset voltage @ $I_P = 0\text{ A}$	U_{OE}	mV	-5		5	$U_{out} - U_{ref}$ @ $U_{ref} = 2.5\text{ V}$
Electrical offset current referred to primary	I_{OE}	A	-0.75		0.75	
Temperature coefficient of U_{ref}	TCU_{ref}	ppm/K	-170		170	-40 °C ... 105 °C
Temperature coefficient of U_{OE}	TCU_{OE}	mV/K	-0.075		0.075	-40 °C ... 105 °C
Offset drift referred to primary @ $I_P = 0\text{ A}$	TCI_{OE}	mA/K	-11.25		11.25	-40 °C ... 105 °C
External detection threshold sensitivity	S_{th}	mV/A		6.667		800 mV @ I_{PN}
Sensitivity error @ I_{PN}	ε_S	%	-0.5		0.5	Factory adjustment (straight bus-bar)
Temperature coefficient of S	TCS	ppm/K	-350		350	-40 °C ... 105 °C
Linearity error 0 ... I_{PN}	ε_L	% of I_{PN}	-0.5		0.5	
Linearity error 0 ... I_{PM}	ε_L	% of I_{PM}	-0.5		0.5	
Magnetic offset current (@ $10 \times I_{PN}$) referred to primary	I_{OM}	A	-0.92		0.92	One turn
Delay time to 10 % of the final output value for I_{PN} step	t_{D10}	μs			2.5	@ 50 A/ μs
Delay time to 90 % of the final output value for I_{PN} step	t_{D90}	μs			3.5	@ 50 A/ μs
Frequency bandwidth (-3 dB)	BW	kHz		100		Small signals
Noise voltage spectral density (100 Hz ... 100 kHz)	u_{no}	$\mu\text{V}/\sqrt{\text{Hz}}$			5.3	
RMS noise voltage (DC ... 10 kHz) (DC ... 100 kHz) (DC ... 1 MHz)	U_{no}	mVpp		3.2 7.5 14.6		
Primary current, detection threshold	I_{PTh}	A	$2.64 \times I_{PN}$	$2.93 \times I_{PN}$	$3.22 \times I_{PN}$	Peak value $\pm 10\%$, overcurrent detection OCD
Sum of sensitivity and linearity @ I_{PN}	ε_{SL}	% of I_{PN}	-1		1	
Sum of sensitivity and linearity @ I_{PN} @ $T_A = +105\text{ °C}$	ε_{SL105}	% of I_{PN}	-4.55		4.55	See formula note ³⁾
Sum of sensitivity and linearity @ I_{PN} @ $T_A = +85\text{ °C}$	ε_{SL85}	% of I_{PN}	-3.66		3.66	See formula note ³⁾

Notes: ¹⁾ 3.3 V SP version available

²⁾ EEPROM in an error state makes the transducer behave like a reverse current saturation. Use of the OCD may help to differentiate the two cases

³⁾

$$\varepsilon_{SL}(T_A) = \varepsilon_{SL25} + \left(TCS + \frac{TCI_{OE}}{I_{PN}} \right) \times |T_A - 25|$$

Electrical data HO 150-P-0100

 At $T_A = 25\text{ °C}$, $U_C = +5\text{ V}$, $R_L = 10\text{ k}\Omega$ unless otherwise noted (see Min, Max, typ. definition paragraph in page 14).

Parameter	Symbol	Unit	Min	Typ	Max	Comment
Primary nominal RMS current	I_{PN}	A		150		
Primary current, measuring range	I_{PM}	A	-375		375	@ $U_C \geq 4.6\text{ V}$
Number of primary turns	N_p	-		1		See application information
Supply voltage ¹⁾	U_C	V	4.5	5	5.5	
Current consumption	I_C	mA		19	25	
Reference voltage (output)	U_{ref}	V	2.48	2.5	2.52	Internal reference
Reference voltage (input)	U_{ref}	V	0.5		2.65	External reference
Output voltage range @ I_{PM}	$U_{out} - U_{ref}$	V	-2		2	Over operating temperature range
U_{ref} output resistance	R_{ref}	Ω	130	200	300	Series
U_{out} output resistance	R_{out}	Ω		2	5	Series
Load capacitance	C_L	nF	0		6	
OCD output on resistance	R_{onOCD}	Ω	70	95	150	Open drain, active low Over operating temperature range
OCD output hold time	$t_{holdOCD}$	ms	0.7	1	1.4	Additional time after threshold has released
EEPROM control	U_{out}	mV	0		50	U_{out} forced to GND when EEPROM in an error state ²⁾
Electrical offset voltage @ $I_p = 0\text{ A}$	U_{OE}	mV	-5		5	$U_{out} - U_{ref}$ @ $U_{ref} = 2.5\text{ V}$
Electrical offset current referred to primary	I_{OE}	A	-0.94		0.94	
Temperature coefficient of U_{ref}	TCU_{ref}	ppm/K	-170		170	-40 °C ... 105 °C
Temperature coefficient of U_{OE}	TCU_{OE}	mV/K	-0.075		0.075	-40 °C ... 105 °C
Offset drift referred to primary @ $I_p = 0\text{ A}$	TCI_{OE}	mA/K	-14.1		14.1	-40 °C ... 105 °C
External detection threshold sensitivity	S_{th}	mV/A		5.333		800 mV @ I_{PN}
Sensitivity error @ I_{PN}	ϵ_S	%	-0.5		0.5	Factory adjustment (straight bus-bar)
Temperature coefficient of S	TCS	ppm/K	-350		350	-40 °C ... 105 °C
Linearity error 0 ... I_{PN}	ϵ_L	% of I_{PN}	-0.5		0.5	
Linearity error 0 ... I_{PM}	ϵ_L	% of I_{PM}	-0.5		0.5	
Magnetic offset current (@ $10 \times I_{PN}$) referred to primary	I_{OM}	A	-0.92		0.92	One turn
Delay time to 10 % of the final output value for I_{PN} step	t_{D10}	μs			2.5	@ 50 A/ μs
Delay time to 10 % of the final output value for I_{PN} step	t_{D90}	μs			3.5	@ 50 A/ μs
Frequency bandwidth (-3 dB)	BW	kHz		100		Small signals
Noise voltage spectral density (100 Hz ... 100 kHz)	u_{no}	$\mu\text{V}/\sqrt{\text{Hz}}$			4.5	
RMS noise voltage (DC ... 10 kHz) (DC ... 100 kHz) (DC ... 1 MHz)	U_{no}	mVpp		2.9 6.2 12.3		
Primary current, detection threshold	I_{PTh}	A	$2.64 \times I_{PN}$	$2.93 \times I_{PN}$	$3.22 \times I_{PN}$	Peak value $\pm 10\%$, overcurrent detection OCD
Sum of sensitivity and linearity @ I_{PN}	ϵ_{SL}	% of I_{PN}	-1		1	
Sum of sensitivity and linearity @ I_{PN} @ $T_A = +105\text{ °C}$	ϵ_{SL105}	% of I_{PN}	-4.55		4.55	See formula note ³⁾
Sum of sensitivity and linearity @ I_{PN} @ $T_A = +85\text{ °C}$	ϵ_{SL85}	% of I_{PN}	-3.66		3.66	See formula note ³⁾

Notes: ¹⁾ 3.3 V SP version available

²⁾ EEPROM in an error state makes the transducer behave like a reverse current saturation. Use of the OCD may help to differentiate the two cases

³⁾

$$\epsilon_{SL}(T_A) = \epsilon_{SL25} + \left(TCS + \frac{TCI_{OE}}{I_{PN}} \right) \times |T_A - 25|$$

Electrical data HO 180-P-0100

 At $T_A = 25\text{ °C}$, $U_C = +5\text{ V}$, $R_L = 10\text{ k}\Omega$ unless otherwise noted (see Min, Max, typ. definition paragraph in page 14).

Parameter	Symbol	Unit	Min	Typ	Max	Comment
Primary nominal RMS current	I_{PN}	A		180		
Primary current, measuring range	I_{PM}	A	-450		450	@ $U_C \geq 4.6\text{ V}$
Number of primary turns	N_P	-		1		See application information
Supply voltage ¹⁾	U_C	V	4.5	5	5.5	
Current consumption	I_C	mA		19	25	
Reference voltage (output)	U_{ref}	V	2.48	2.5	2.52	Internal reference
Reference voltage (input)	U_{ref}	V	0.5		2.65	External reference
Output voltage range @ I_{PM}	$U_{out} - U_{ref}$	V	-2		2	Over operating temperature range
U_{ref} output resistance	R_{ref}	Ω	130	200	300	Series
U_{out} output resistance	R_{out}	Ω		2	5	Series
Load capacitance	C_L	nF	0		6	
OCD output on resistance	$R_{on\text{OCD}}$	Ω	70	95	150	Open drain, active low Over operating temperature range
OCD output hold time	$t_{hold\text{OCD}}$	ms	0.7	1	1.4	Additional time after threshold has released
EEPROM control	U_{out}	mV	0		50	U_{out} forced to GND when EEPROM in an error state ²⁾
Electrical offset voltage @ $I_P = 0\text{ A}$	U_{OE}	mV	-5		5	$U_{out} - U_{ref}$ @ $U_{ref} = 2.5\text{ V}$
Electrical offset current referred to primary	I_{OE}	A	-1.13		1.13	
Temperature coefficient of U_{ref}	TCU_{ref}	ppm/K	-170		170	-40 °C ... 105 °C
Temperature coefficient of U_{OE}	TCU_{OE}	mV/K	-0.075		0.075	-40 °C ... 105 °C
Offset drift referred to primary @ $I_P = 0\text{ A}$	TCI_{OE}	mA/K	-16.9		16.9	-40 °C ... 105 °C
External detection threshold sensitivity	S_{th}	mV/A		4.444		800 mV @ I_{PN}
Sensitivity error @ I_{PN}	ε_S	%	-0.5		0.5	Factory adjustment (straight bus-bar)
Temperature coefficient of S	TCS	ppm/K	-350		350	-40 °C ... 105 °C
Linearity error 0 ... I_{PN}	ε_L	% of I_{PN}	-0.5		0.5	
Linearity error 0 ... I_{PM}	ε_L	% of I_{PM}	-0.5		0.5	
Magnetic offset current (@ $10 \times I_{PN}$) referred to primary	I_{OM}	A	-0.92		0.92	One turn
Delay time to 10 % of the final output value for I_{PN} step	t_{D10}	μs			2.5	@ 50 A/ μs
Delay time to 90 % of the final output value for I_{PN} step	t_{D90}	μs			3.5	@ 50 A/ μs
Frequency bandwidth (-3 dB)	BW	kHz		100		Small signals
Noise voltage spectral density (100 Hz ... 100 kHz)	u_{no}	$\mu\text{V}/\sqrt{\text{Hz}}$			4	
RMS noise voltage (DC ... 10 kHz) (DC ... 100 kHz) (DC ... 1 MHz)	U_{no}	mVpp		2.7 5.4 10.8		
Primary current, detection threshold	I_{PTh}	A	$2.64 \times I_{PN}$	$2.93 \times I_{PN}$	$3.22 \times I_{PN}$	Peak value $\pm 10\%$, overcurrent detection OCD
Sum of sensitivity and linearity @ I_{PN}	ε_{SL}	% of I_{PN}	-1		1	
Sum of sensitivity and linearity @ I_{PN} @ $T_A = +105\text{ °C}$	ε_{SL105}	% of I_{PN}	-4.55		4.55	See formula note ³⁾
Sum of sensitivity and linearity @ I_{PN} @ $T_A = +85\text{ °C}$	ε_{SL85}	% of I_{PN}	-3.66		3.66	See formula note ³⁾

Notes: ¹⁾ 3.3 V SP version available

²⁾ EEPROM in an error state makes the transducer behave like a reverse current saturation. Use of the OCD may help to differentiate the two cases

³⁾

$$\varepsilon_{SL}(T_A) = \varepsilon_{SL25} + \left(TCS + \frac{TCI_{OE}}{I_{PN}} \right) \times |T_A - 25|$$

Electrical data HO 240-P-0100

 At $T_A = 25\text{ °C}$, $U_C = +5\text{ V}$, $R_L = 10\text{ k}\Omega$ unless otherwise noted (see Min, Max, typ. definition paragraph in page 14).

Parameter	Symbol	Unit	Min	Typ	Max	Comment
Primary nominal RMS current	I_{PN}	A		240		
Primary current, measuring range	I_{PM}	A	-600		600	@ $U_C \geq 4.6\text{ V}$
Number of primary turns	N_P	-		1		See application information
Supply voltage ¹⁾	U_C	V	4.5	5	5.5	
Current consumption	I_C	mA		19	25	
Reference voltage (output)	U_{ref}	V	2.48	2.5	2.52	Internal reference
Reference voltage (input)	U_{ref}	V	0.5		2.65	External reference
Output voltage range @ I_{PM}	$U_{out} - U_{ref}$	V	-2		2	Over operating temperature range
U_{ref} output resistance	R_{ref}	Ω	130	200	300	Series
U_{out} output resistance	R_{out}	Ω		2	5	Series
Load capacitance	C_L	nF	0		6	
OCD output on resistance	$R_{on\text{OCD}}$	Ω	70	95	150	Open drain, active low Over operating temperature range
OCD output hold time	$t_{hold\text{OCD}}$	ms	0.7	1	1.4	Additional time after threshold has released
EEPROM control	U_{out}	mV	0		50	U_{out} forced to GND when EEPROM in an error state ²⁾
Electrical offset voltage @ $I_P = 0\text{ A}$	U_{OE}	mV	-5		5	$U_{out} - U_{ref}$ @ $U_{ref} = 2.5\text{ V}$
Electrical offset current referred to primary	I_{OE}	A	-1.5		1.5	
Temperature coefficient of U_{ref}	TCU_{ref}	ppm/K	-170		170	-40 °C ... 105 °C
Temperature coefficient of U_{OE}	TCU_{OE}	mV/K	-0.075		0.075	-40 °C ... 105 °C
Offset drift referred to primary @ $I_P = 0\text{ A}$	TCI_{OE}	mA/K	-22.5		22.5	-40 °C ... 105 °C
External detection threshold sensitivity	S_{th}	mV/A		3.333		800 mV @ I_{PN}
Sensitivity error @ I_{PN}	ε_S	%	-0.5		0.5	Factory adjustment (straight bus-bar)
Temperature coefficient of S	TCS	ppm/K	-350		350	-40 °C ... 105 °C
Linearity error 0 ... I_{PN}	ε_L	% of I_{PN}	-0.5		0.5	
Linearity error 0 ... I_{PM}	ε_L	% of I_{PM}	-0.5		0.5	
Magnetic offset current (@ $10 \times I_{PN}$) referred to primary	I_{OM}	A	-0.92		0.92	One turn
Delay time to 10 % of the final output value for I_{PN} step	t_{D10}	μs			2.5	@ 50 A/ μs
Delay time to 90 % of the final output value for I_{PN} step	t_{D90}	μs			3.5	@ 50 A/ μs
Frequency bandwidth (-3 dB)	BW	kHz		100		Small signals
Noise voltage spectral density (100 Hz ... 100 kHz)	u_{no}	$\mu\text{V}/\sqrt{\text{Hz}}$			3.5	
RMS noise voltage (DC ... 10 kHz) (DC ... 100 kHz) (DC ... 1 MHz)	U_{no}	mVpp		2.5 5 8.7		
Primary current, detection threshold	I_{PTh}	A	$2.64 \times I_{PN}$	$2.93 \times I_{PN}$	$3.22 \times I_{PN}$	Peak value $\pm 10\%$, overcurrent detection OCD
Sum of sensitivity and linearity @ I_{PN}	ε_{SL}	% of I_{PN}	-1		1	
Sum of sensitivity and linearity @ I_{PN} @ $T_A = +105\text{ °C}$	ε_{SL105}	% of I_{PN}	-4.55		4.55	See formula note ³⁾
Sum of sensitivity and linearity @ I_{PN} @ $T_A = +85\text{ °C}$	ε_{SL85}	% of I_{PN}	-3.66		3.66	See formula note ³⁾

 Notes: ¹⁾ 3.3 V SP version available

²⁾ EEPROM in an error state makes the transducer behave like a reverse current saturation. Use of the OCD may help to differentiate the two cases

$$\varepsilon_{SL}(T_A) = \varepsilon_{SL25} + \left(TCS + \frac{TCI_{OE}}{I_{PN}} \right) \times |T_A - 25|$$

Electrical data HO 250-P-0100

 At $T_A = 25\text{ °C}$, $U_C = +5\text{ V}$, $R_L = 10\text{ k}\Omega$ unless otherwise noted (see Min, Max, typ. definition paragraph in page 14).

Parameter	Symbol	Unit	Min	Typ	Max	Comment
Primary nominal RMS current	I_{PN}	A		250		
Primary current, measuring range	I_{PM}	A	-625		625	@ $U_C \geq 4.6\text{ V}$
Number of primary turns	N_p	-		1		See application information
Supply voltage ¹⁾	U_C	V	4.5	5	5.5	
Current consumption	I_C	mA		19	25	
Reference voltage (output)	U_{ref}	V	2.48	2.5	2.52	Internal reference
Reference voltage (input)	U_{ref}	V	0.5		2.65	External reference
Output voltage range @ I_{PM}	$U_{out} - U_{ref}$	V	-2		2	Over operating temperature range
U_{ref} output resistance	R_{ref}	Ω	130	200	300	Series
U_{out} output resistance	R_{out}	Ω		2	5	Series
Load capacitance	C_L	nF	0		6	
OCD output on resistance	$R_{on\text{OCD}}$	Ω	70	95	150	Open drain, active low Over operating temperature range
OCD output hold time	$t_{hold\text{OCD}}$	ms	0.7	1	1.4	Additional time after threshold has released
EEPROM control	U_{out}	mV	0		50	U_{out} forced to GND when EEPROM in an error state ²⁾
Electrical offset voltage @ $I_p = 0\text{ A}$	U_{OE}	mV	-5		5	$U_{out} - U_{ref}$ @ $U_{ref} = 2.5\text{ V}$
Electrical offset current referred to primary	I_{OE}	A	-1.57		1.57	
Temperature coefficient of U_{ref}	TCU_{ref}	ppm/K	-170		170	-40 °C ... 105 °C
Temperature coefficient of U_{OE}	TCU_{OE}	mV/K	-0.075		0.075	-40 °C ... 105 °C
Offset drift referred to primary @ $I_p = 0\text{ A}$	TCI_{OE}	mA/K	-23.5		23.5	-40 °C ... 105 °C
External detection threshold sensitivity	S_{th}	mV/A		3.2		800 mV @ I_{PN}
Sensitivity error @ I_{PN}	ε_S	%	-0.5		0.5	Factory adjustment (straight bus-bar)
Temperature coefficient of S	TCS	ppm/K	-350		350	-40 °C ... 105 °C
Linearity error 0 ... I_{PN}	ε_L	% of I_{PN}	-0.5		0.5	
Linearity error 0 ... I_{PM}	ε_L	% of I_{PM}	-0.5		0.5	
Magnetic offset current (@ $10 \times I_{PN}$) referred to primary	I_{OM}	A	-0.92		0.92	One turn
Delay time to 10 % of the final output value for I_{PN} step	t_{D10}	μs			2.5	@ 50 A/ μs
Delay time to 90 % of the final output value for I_{PN} step	t_{D90}	μs			3.5	@ 50 A/ μs
Frequency bandwidth (-3 dB)	BW	kHz		100		Small signals
Noise voltage spectral density (100 Hz ... 100 kHz)	u_{no}	$\mu\text{V}/\sqrt{\text{Hz}}$			3.5	
RMS noise voltage (DC ... 10 kHz) (DC ... 100 kHz) (DC ... 1 MHz)	U_{no}	mVpp		2.5 5 8.7		
Primary current, detection threshold	I_{PTh}	A	$2.64 \times I_{PN}$	$2.93 \times I_{PN}$	$3.22 \times I_{PN}$	Peak value $\pm 10\%$, overcurrent detection OCD
Sum of sensitivity and linearity @ I_{PN}	ε_{SL}	% of I_{PN}	-1		1	
Sum of sensitivity and linearity @ I_{PN} @ $T_A = +105\text{ °C}$	ε_{SL105}	% of I_{PN}	-4.55		4.55	See formula note ³⁾
Sum of sensitivity and linearity @ I_{PN} @ $T_A = +85\text{ °C}$	ε_{SL85}	% of I_{PN}	-3.66		3.66	See formula note ³⁾

Notes: ¹⁾ 3.3 V SP version available

²⁾ EEPROM in an error state makes the transducer behave like a reverse current saturation. Use of the OCD may help to differentiate the two cases

³⁾

$$\varepsilon_{SL}(T_A) = \varepsilon_{SL25} + \left(TCS + \frac{TCI_{OE}}{I_{PN}} \right) \times [T_A - 25]$$

HO-P series, measuring range versus external reference voltage

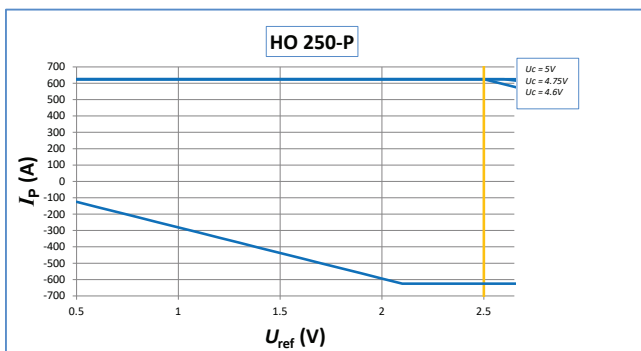
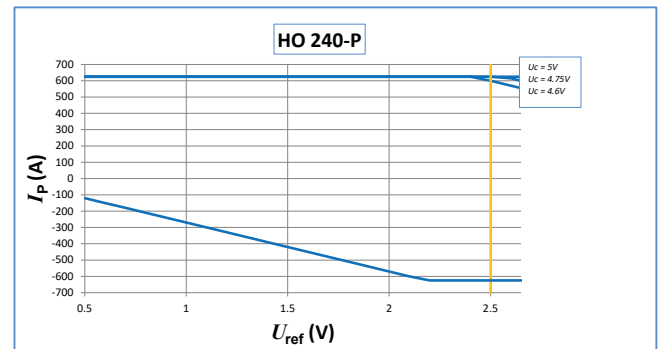
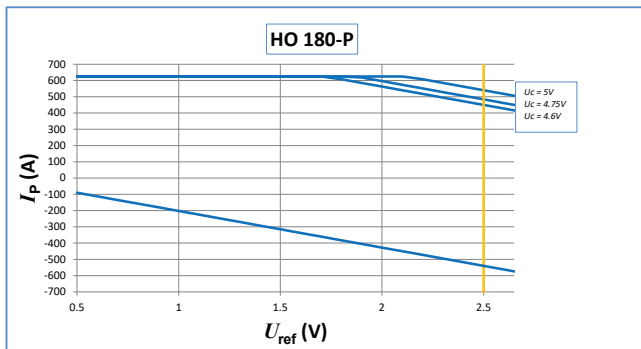
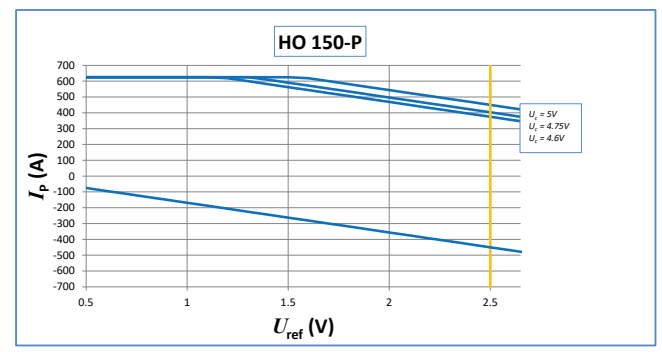
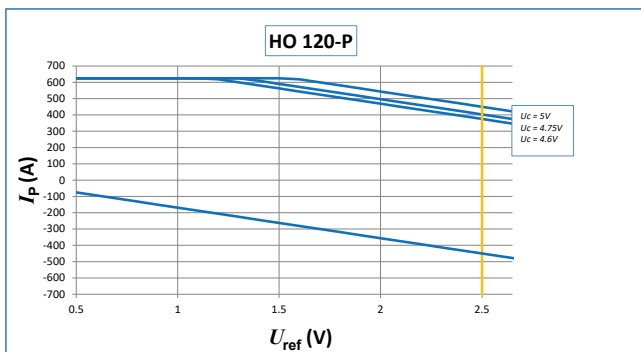
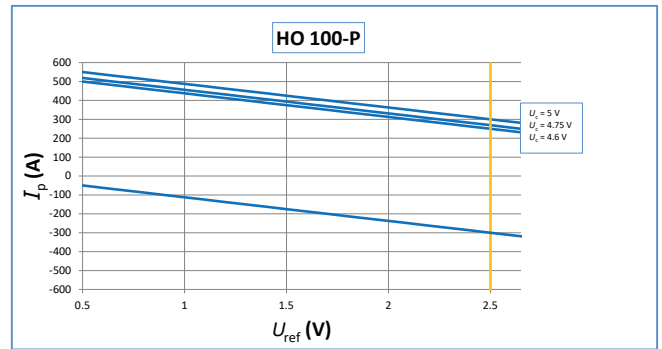
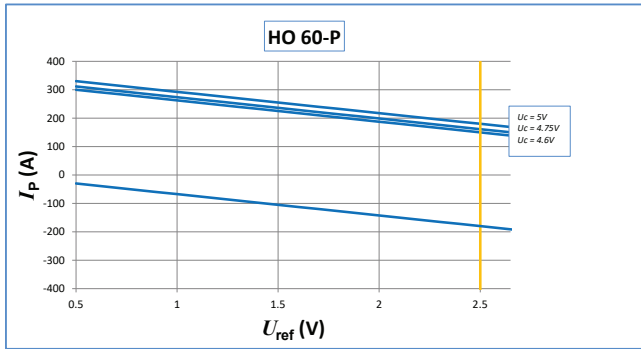

Maximum continuous DC current

For all ranges:

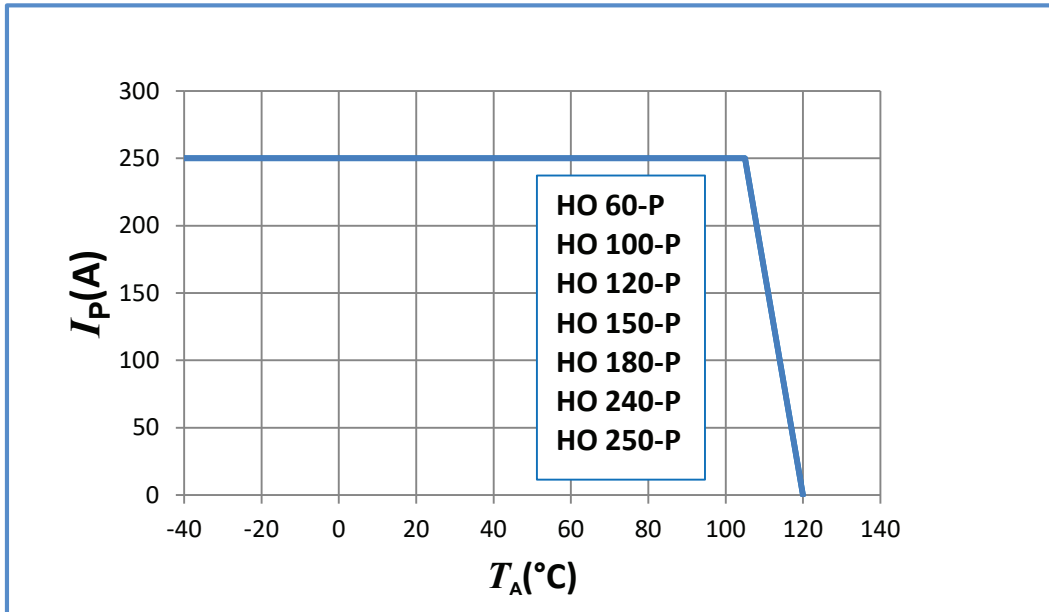

Important notice: whatever the usage and/or application, the transducer primary bar / jumper temperature shall not go above the maximum rating of 120 °C as stated in page 2 of this datasheet.

Frequency derating versus primary current and core temperature increase ΔT (°C)

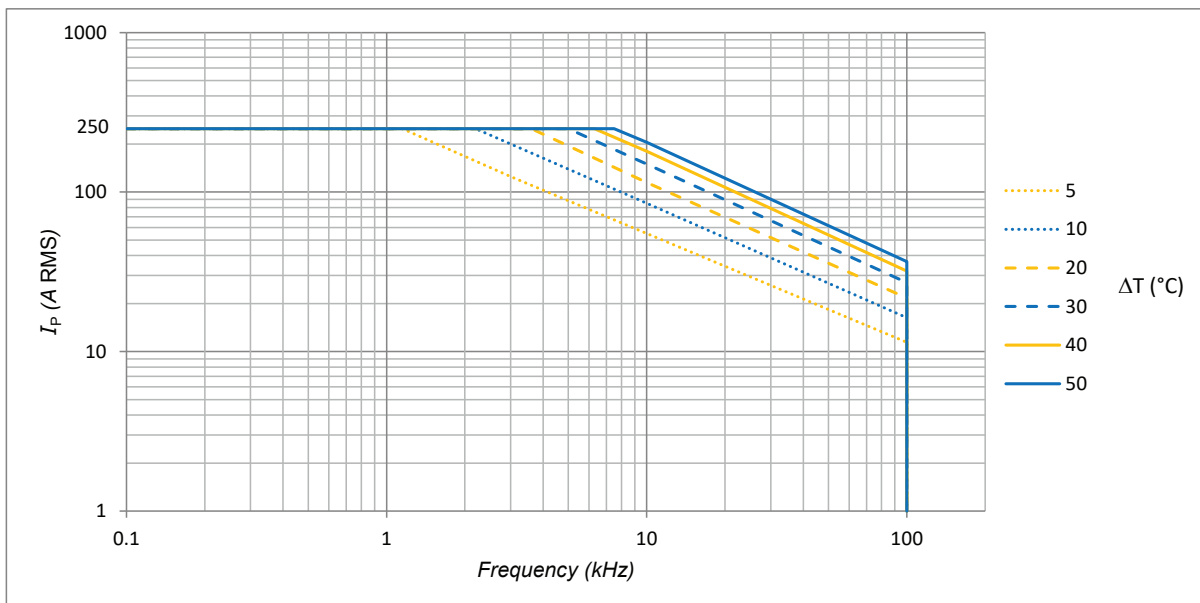

Primary current in A RMS is sine wave.

Example:

Primary current ripple (sine wave): 50 A RMS

Ripple frequency: 20 kHz

- the core temperature increase is 10 °C

HO-P series: name and codification

HO family products may be ordered **on request** ¹⁾ with a dedicated setting of the parameters as described below (standard products are delivered with the setting 0100 according to the table).

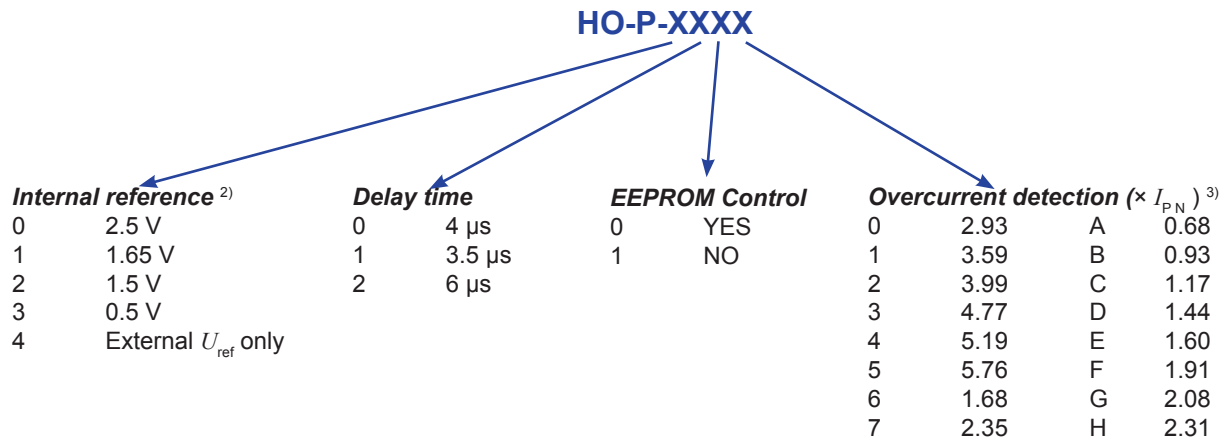

Standard products are:

- HO 60-P-0100
- HO 100-P-0100
- HO 120-P-0100
- HO 150-P-0100
- HO 180-P-0100
- HO 180-P-1100
- HO 240-P-0100
- HO 250-P-0100

Notes: ¹⁾ For dedicated settings, minimum quantities apply, please contact your local LEM support

²⁾ U_{ref} electrical data

U_{ref} parameter	U_{ref} (V)			TCU_{ref} (ppm/K)	
	min	typ	max	min	max
0	2.48	2.5	2.52	-170	170
1	1.63	1.65	1.67	-170	170
2	1.48	1.5	1.52	-170	170
3	0.49	0.5	0.51	-250	250

³⁾ OCD ($\times I_{PN}$) correction table versus range and temperature.

HO-P-010x				
OCD Parameter				
	150	180	240	250
A				
B				
C				
D				
E				
6				
F				
G				
H				
7				
0				
1				
2				
3			5.10	5.60
4			6.7	7.30
5			-	-

Tolerance on OCD value	
$\pm 20\%$	
$\pm 15\%$	
$\pm 10\%$	No change
-	Do not use

All other values or empty cells: no change

Application information

HOxx-P series is designed to be used with a bus-bar or a cable ¹⁾ to carry the current through the aperture with a maximum cross-section of 8 × 15 mm.

The 2 jumpers should be used as mechanical fixation on the PCBA and must be kept in open circuit.

HO-P series: output compatibility with HAIS series

Reference	I_{PN} (A)	I_{PM} (A)	I_{PM} / I_{PN}	$\frac{U_{out} - U_{ref}}{I_{PN}} (V)$	Reference	I_{PN} (A)	I_{PM} (A)	I_{PM} / I_{PN}	$\frac{U_{out} - U_{ref}}{I_{PN}} (V)$
HO 60-P	60	150	2.5	0.8	HAIS 50-P	50	150	3	0.625
HO 100-P	100	250	2.5	0.8					
HO 120-P	120	300	2.5	0.8	HAIS 100-P	100	300	3	0.625
HO 150-P	150	375	2.5	0.8					
HO 180-P	180	450	2.5	0.8	HAIS 150-P	150	450	3	0.625
HO 240-P	240	600	2.5	0.8	HAIS 200-P	200	600	3	0.625
HO 250-P	250	625	2.5	0.8					

The HO-P gives the same output levels as the HAIS-P referring to the HAIS nominal currents.

This allows easier replacement of HAIS by HO-P in existing applications.

Note: ¹⁾ The maximum magnetic offset referred to primary is inversely proportional to the number of turns, thus is divided by 2 with 2 turns.

Definition of typical, minimum and maximum values

Minimum and maximum values for specified limiting and safety conditions have to be understood as such as well as values shown in “typical” graphs.

On the other hand, measured values are part of a statistical distribution that can be specified by an interval with upper and lower limits and a probability for measured values to lie within this interval.

Unless otherwise stated (e.g. “100 % tested”), the LEM definition for such intervals designated with “min” and “max” is that the probability for values of samples to lie in this interval is 99.73 %.

For a normal (Gaussian) distribution, this corresponds to an interval between -3 sigma and +3 sigma. If “typical” values are not obviously mean or average values, those values are defined to delimit intervals with a probability of 68.27 %, corresponding to an interval between -sigma and +sigma for a normal distribution.

Typical, maximal and minimal values are determined during the initial characterization of the product.

Remark

Installation of the transducer must be done, unless otherwise specified on the datasheet, according to LEM Transducer Generic Mounting Rules. Please refer to LEM document N°ANE120504 available on our Web site:

<https://www.lem.com/en/file/3137/download/Safety>

Safety

This transducer must be used in limited-energy secondary circuits.



This transducer must be used in electric/electronic equipment with respect to applicable standards and safety requirements in accordance with the manufacturer's operating instructions.



Caution, risk of electrical shock.

When operating the transducer, certain parts of the module can carry hazardous voltage (e.g. primary bus bar, power supply). Ignoring this warning can lead to injury and/or cause serious damage.

This transducer is a build-in device, whose conducting parts must be inaccessible after installation.

A protective housing or additional shield could be used.

Main supply must be able to be disconnected.

PCB Footprint in mm

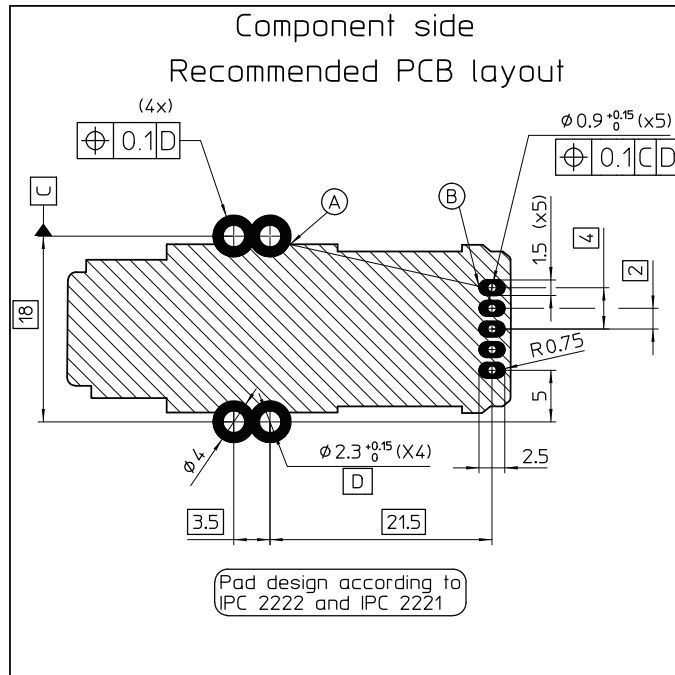

Assembly on PCB

- Recommended PCB hole diameter 2.15 mm for primary pin
0.9 mm for secondary pin
- Maximum PCB thickness 2.4 mm
- Wave soldering profile maximum 260 °C, 10 s
No clean process only

Insulation distance (nominal values):

	d_{cp}	d_{cl}
On PCB: A - B	18.85 mm	-
Between jumper and secondary pin	21.1 mm	20.9 mm
Between primary busbar and secondary pin	14.6 mm	-
Between primary busbar and jumper	-	8 mm
Between primary busbar and core	-	11.34 mm
Between core and secondary terminal	-	1.18 mm

Dimensions HO-P series (mm, general linear tolerance ± 0.3 mm)

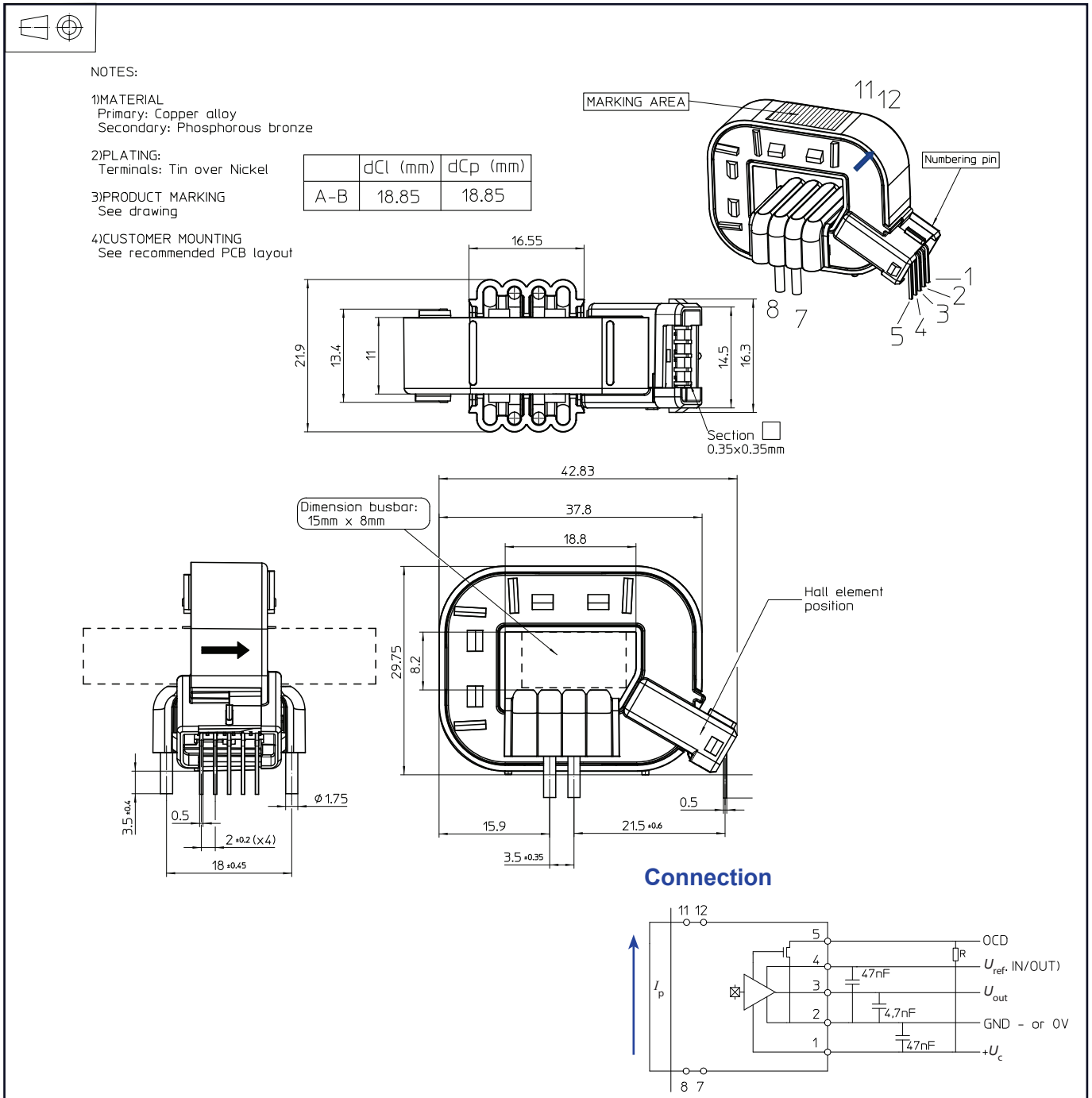

Remark:

- U_{out} is positive with respect to U_{ref} when positive I_p flows in direction of the arrow shown on the drawing above.