

HD34-24-31SE-072 ✓ ACTIVE

DEUTSCH | DEUTSCH HD, DEUTSCH HD30

TE Internal #: HD34-24-31SE-072

Housing for Female Terminals, Wire-to-Wire, 31 Position, Sealable, Wire & Cable, Power & Signal, Panel Mount, -55 – 125 °C [-67 – 257 °F], Hybrid

[View on TE.com >](#)



Connectors > Automotive Connectors > Connector Housings > DEUTSCH HD30 HOUSINGS



Connector & Housing Type: **Housing for Female Terminals**

Mating Pin Diameter: **1.59 mm [.063 in]**

Connector System: **Wire-to-Wire**

Number of Positions: **31**

Sealable: **Yes**

[All DEUTSCH HD30 HOUSINGS \(357\)](#)

Features

Product Type Features

Connector Shape	Circular
Connector & Housing Type	Housing for Female Terminals
Connector System	Wire-to-Wire
Sealable	Yes
Hybrid Connector	No
Primary Locking Feature	Contact Retainer
Connector & Contact Terminates To	Wire & Cable

Configuration Features

Blank Cavity Position	0
Connector Modification	Adapter
Connector Seal Code	E Seal
Number of Positions	31

Electrical Characteristics

Operating Voltage	250 VAC
Nominal Voltage Architecture	12 V, 24 V

Body Features

Cable Exit Angle	180°
Body Material	Aluminum

Contact Features

Contact Size	Size 16
Contact Type	Socket
Mating Pin Diameter	1.59 mm[.063 in]
Contact Current Rating (Max)	13 A

Mechanical Attachment

Mounting Feature	With
Terminal Position Assurance	No
Strain Relief	Add By Accessory
Mating Alignment Type	Guide Post
Mating Alignment	With
Connector Mounting Type	Panel Mount

Dimensions

Product Width	50.8 mm[2 in]
Product Length	68.5 mm[2.697 in]
Product Height	47.53 mm[1.875 in]
Accepts Wire Insulation Diameter Range	1.35 – 2.69 mm[.053 – .106 in]

Usage Conditions

Operating Temperature (Max)	125 °C[257 °F]
Operating Temperature Range	-55 – 125 °C[-67 – 257 °F]

Operation/Application

Circuit Application	Power & Signal
---------------------	----------------

Industry Standards

Degree of Protection	IP67
----------------------	------

Packaging Features

Packaging Quantity	80
--------------------	----



Packaging Method	Box
Other	
Serviceable	Yes
Connector Position Assurance Capable	No

Product Compliance

[For compliance documentation, visit the product page on TE.com>](#)

EU RoHS Directive 2011/65/EU	Compliant
EU ELV Directive 2000/53/EC	Compliant
China RoHS 2 Directive MIIT Order No 32, 2016	No Restricted Materials Above Threshold
EU REACH Regulation (EC) No. 1907/2006	Current ECHA Candidate List: JUNE 2022 (224) Candidate List Declared Against: JUNE 2022 (224) Does not contain REACH SVHC
Halogen Content	Not Low Halogen - contains Br or Cl > 900 ppm.
Solder Process Capability	Not reviewed for solder process capability

Product Compliance Disclaimer

This information is provided based on reasonable inquiry of our suppliers and represents our current actual knowledge based on the information they provided. This information is subject to change. The part numbers that TE has identified as EU RoHS compliant have a maximum concentration of 0.1% by weight in homogenous materials for lead, hexavalent chromium, mercury, PBB, PBDE, DBP, BBP, DEHP, DIBP, and 0.01% for cadmium, or qualify for an exemption to these limits as defined in the Annexes of Directive 2011/65/EU (RoHS2). Finished electrical and electronic equipment products will be CE marked as required by Directive 2011/65/EU. Components may not be CE marked. Additionally, the part numbers that TE has identified as EU ELV compliant have a maximum concentration of 0.1% by weight in homogenous materials for lead, hexavalent chromium, and mercury, and 0.01% for cadmium, or qualify for an exemption to these limits as defined in the Annexes of Directive 2000/53/EC (ELV). Regarding the REACH Regulation, the information TE provides on SVHC in articles for this part number is based on the latest European Chemicals Agency (ECHA) 'Guidance on requirements for substances in articles' posted at this URL: <https://echa.europa.eu/guidance-documents/guidance-on-reach>

Compatible Parts





TE Part # CAT-D48-SFT273
DEUTSCH STAMPED & FORMED CONTACTS

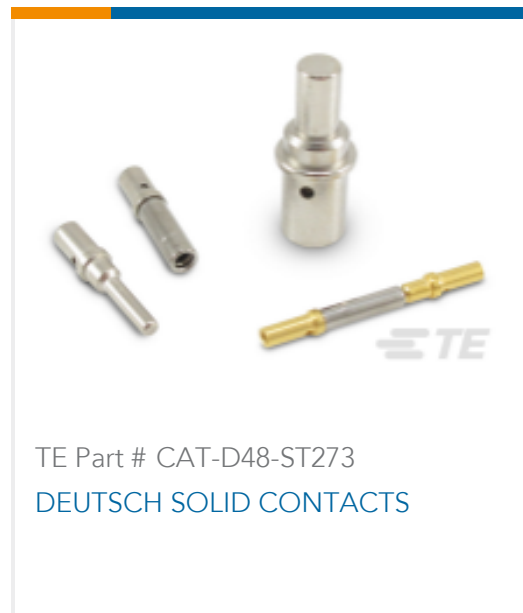

TE Part # CAT-D48-ST273
DEUTSCH SOLID CONTACTS



TE Part # 114017-ZZ
SEALING PLUG, SIZE 12/16, WHT



TE Part # HD30-24BT-BK
BOOT, 24SZ, ST, BLK



TE Part # 16-04477
GASKET, 24SZ, BLK, HD30



TE Part # HD30-24BT
BOOT, 24SZ, ST, GRY



TE Part # HD30-24BT-90-BK
BOOT, 24SZ, RA, BLK

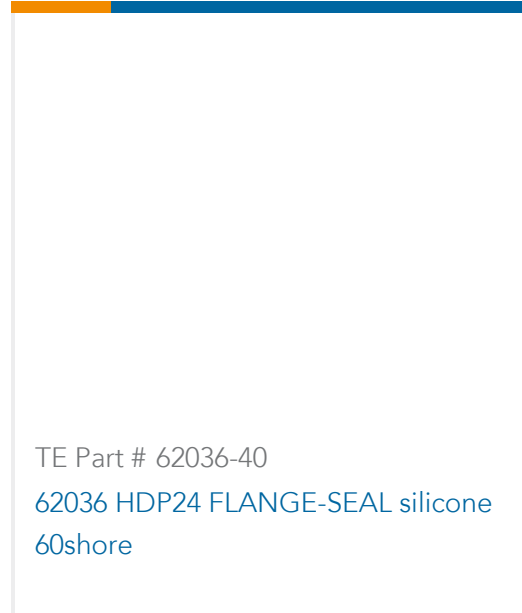

TE Part # 62036-40
62036 HDP24 FLANGE-SEAL silicone 60shore

Also in the Series | **DEUTSCH HD**



Automotive Connector Caps & Covers (62)

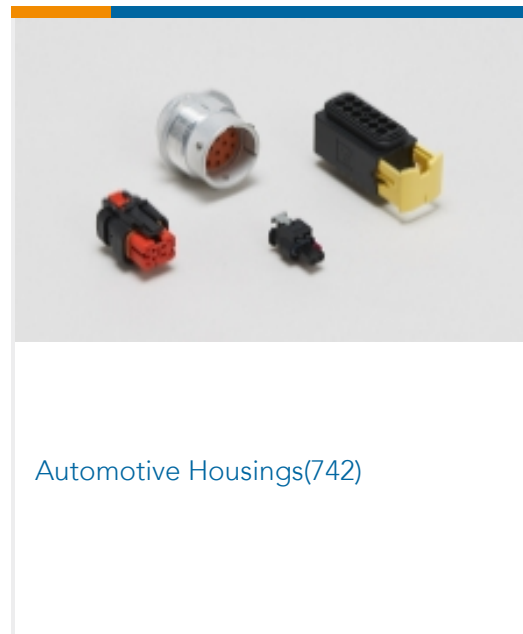

Automotive Housings(742)



Automotive Seals & Cavity Plugs(10)

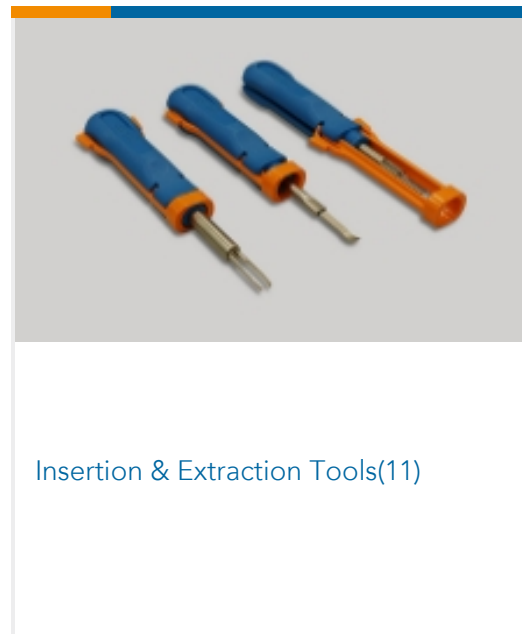

Insertion & Extraction Tools(11)

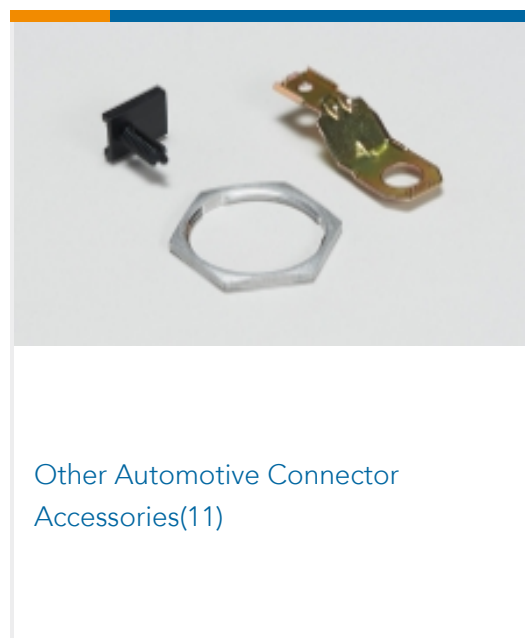

Other Automotive Connector Accessories(11)



PCB Headers & Receptacles(1)

Also in the Series | **DEUTSCH HD30**



Automotive Connector Caps & Covers (18)

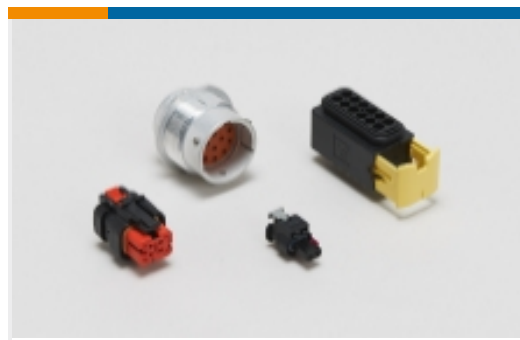

Automotive Housings(359)



Automotive Seals & Cavity Plugs(11)



Insertion & Extraction Tools(10)



Other Automotive Connector Accessories(6)

Customers Also Bought



TE Part #HD36-24-31PE-059
DEUTSCH HD30 HOUSINGS



TE Part #112263-90
PANEL NUT, SIZE 24, HD30



TE Part #DTP04-4P
REC, 4P, GRY, N



TE Part #DTM06-3S-E007
PLG, 3P, GRY, N, XCAP

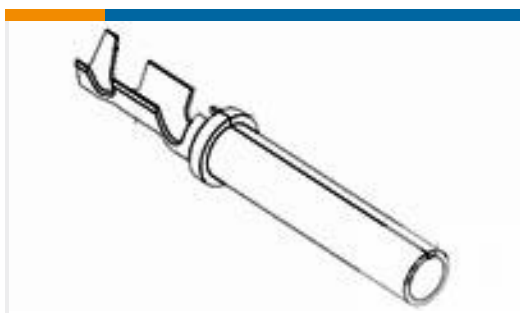

TE Part #1924464-2
SOC, SF, SIZE 16, 18-20 AWG, NI/SN



TE Part #0411-291-1405
EXT TOOL, SIZE 16, 14-16 AWG, N, GRN



TE Part #HD10-9-GKT
GASKET, 9SZ, BLK, HD10

Documents

Product Drawings

[REC, 31P, AL, E, THD ADPT, DRAIN, 16, S](#)

English

CAD Files

[3D PDF](#)

[3D](#)

[Customer View Model](#)

[ENG_CVM_CVM_HD34-24-31SE-072_A.2d_dxf.zip](#)



English

Customer View Model

[ENG_CVM_CVM_HD34-24-31SE-072_A.3d_igs.zip](#)

English

Customer View Model

[ENG_CVM_CVM_HD34-24-31SE-072_A.3d_stp.zip](#)

English

By downloading the CAD file I accept and agree to the [Terms and Conditions](#) of use.

Datasheets & Catalog Pages

[ICT Terminals and Connectors Catalogue](#)

English

Product Specifications

[Application Specification](#)

English