

SPECIFICATION

- Part No. : **G30.B.108111**
- Product Name : Olympian Direct Mount Ultra Wide-Band
4G/3G/2G
LTE / Cellular / Wi-Fi Antenna
For 2G/3G/4G Applications
- Feature : 698 to 960MHz, 2.4GHz and 1710 to 2700MHz
Heavy duty screw mount
UV and Features vandal resistant ABS
housing and thread
IP67 compliant
Standard is 1M RG-316 SMA(M)
Cables and Connectors Customizable
CE Certified
RoHS & REACH Compliant



1.Introduction

The G30 Olympian is a high performance screw mount wide-band cellular antenna for external use on vehicles and outdoor assets worldwide. Omni-directional high gain and high efficiency across all bands ensures constant reception and transmission. This is vital for today's high data bandwidth applications in video and mobile broadband.

Durable UV resistant ABS housing is resistant to vandalism and direct attack. At only 48mm height it complies with the latest EU height restrictions directives for roof-mounted objects. This antenna is mounted on metal and plastic structures and is locked from the inside of the structure by a nut. Adhesive foam at the base provides a watertight seal to the mounting structure. High quality waterproof and corrosion resistant Teflon jacket RG316 is used for the cable.

Two of these G30 separated at distance from each other are ideal for the latest LTE MIMO spatial diversity applications.

Customized cable length and connectors are available. Taoglas recommend a minimum cable length of 70mm when used on a ground plane to achieve an efficiency of greater than 40% in the 900MHz band and greater than 60% in the 1800MHz band. For further information please contact your regional Taoglas customer support team.

2. Specification

ELECTRICAL						
Standard	4G/3G/2G					2.4GHz
Operation Frequency (MHz)	700~960	1710~2170	2305~2360	2500~2800	3400~3500	2400~2483
Peak Gain	1.2 dBi	3.2dBi		2.5dBi		1.5dBi
Average Gain	-4.5 dB	-2.5dB		-4.5dB		-4.5dB
Efficiency	40%	55%		40%		38%
VSWR	<3.0:1					
Impedance	50Ω					
Polarization	Linear					
Radiation Properties	Omni-directional					
Max Input Power	5 W					

* The G30 antenna performance was measured with 30X30 cm metal plate.

MECHANICAL	
Dimensions (mm)	Height=48mm and Diameter=50mm
Cable	Length=1m RG316*
Casing	UV Resistant ABS
Base and Thread	Nickel plated steel
Weather proof gasket	CR4305 foam with 3M9448B double-side adhesive
Connector	SMA(M) Fully Customizable
Nut	Nut M12 -
Sealant	Rubber Stopper
Weight	66g
Recommended Torque	2.94N·m
Max Torque	3.92N·m

*Minimum cable length 1M

ENVIRONMENTAL	
Protection	IP67
Corrosion	5% NACI for 96hrs- Nickel plated steel base and thread
Temperature Range	-40°C to +85°C
Thermal Shock	100 cycles -40°C to +85°C
Humidity	Non-condensing 65 C 95% RH
Shock (Drop Test)	1m drop on concrete 6 axes
Cable Pull	8Kgf

LTE BANDS			
Band Number	LTE / LTE-Advanced / WCDMA / HSPA / HSPA+ / TD-SCDMA		
	Uplink	Downlink	Covered
1	UL: 1920 to 1980	DL: 2110 to 2170	✓
2	UL: 1850 to 1910	DL: 1930 to 1990	✓
3	UL: 1710 to 1785	DL: 1805 to 1880	✓
4	UL: 1710 to 1755	DL: 2110 to 2155	✓
5	UL: 824 to 849	DL: 869 to 894	✓
7	UL: 2500 to 2570	DL: 2620 to 2690	✓
8	UL: 880 to 915	DL: 925 to 960	✓
9	UL: 1749.9 to 1784.9	DL: 1844.9 to 1879.9	✓
11	UL: 1427.9 to 1447.9	DL: 1475.9 to 1495.9	✗
12	UL: 699 to 716	DL: 729 to 746	✓
13	UL: 777 to 787	DL: 746 to 756	✓
14	UL: 788 to 798	DL: 758 to 768	✓
17	UL: 704 to 716	DL: 734 to 746 (LTE only)	✓
18	UL: 815 to 830	DL: 860 to 875 (LTE only)	✓
19	UL: 830 to 845	DL: 875 to 890	✓
20	UL: 832 to 862	DL: 791 to 821	✓
21	UL: 1447.9 to 1462.9	DL: 1495.9 to 1510.9	✗
22	UL: 3410 to 3490	DL: 3510 to 3590	✗
23	UL: 2000 to 2020	DL: 2180 to 2200 (LTE only)	✓
24	UL: 1625.5 to 1660.5	DL: 1525 to 1559 (LTE only)	✗
25	UL: 1850 to 1915	DL: 1930 to 1995	✓
26	UL: 814 to 849	DL: 859 to 894	✓
27	UL: 807 to 824	DL: 852 to 869 (LTE only)	✓
28	UL: 703 to 748	DL: 758 to 803 (LTE only)	✓
29	UL: -	DL: 717 to 728 (LTE only)	✓
30	UL: 2305 to 2315	DL: 2350 to 2360 (LTE only)	✓
31	UL: 452.5 to 457.5	DL: 462.5 to 467.5 (LTE only)	✗
32	UL: -	DL: 1452 - 1496	✗
35		1850 to 1910	✓
38		2570 to 2620	✓
39		1880 to 1920	✓
40		2300 to 2400	✓
41		2496 to 2690	✓
42		3400 to 3600	✗
43		3600 to 3800	✗

*Covered bands represent an efficiency greater than 20%

1. Test Setup

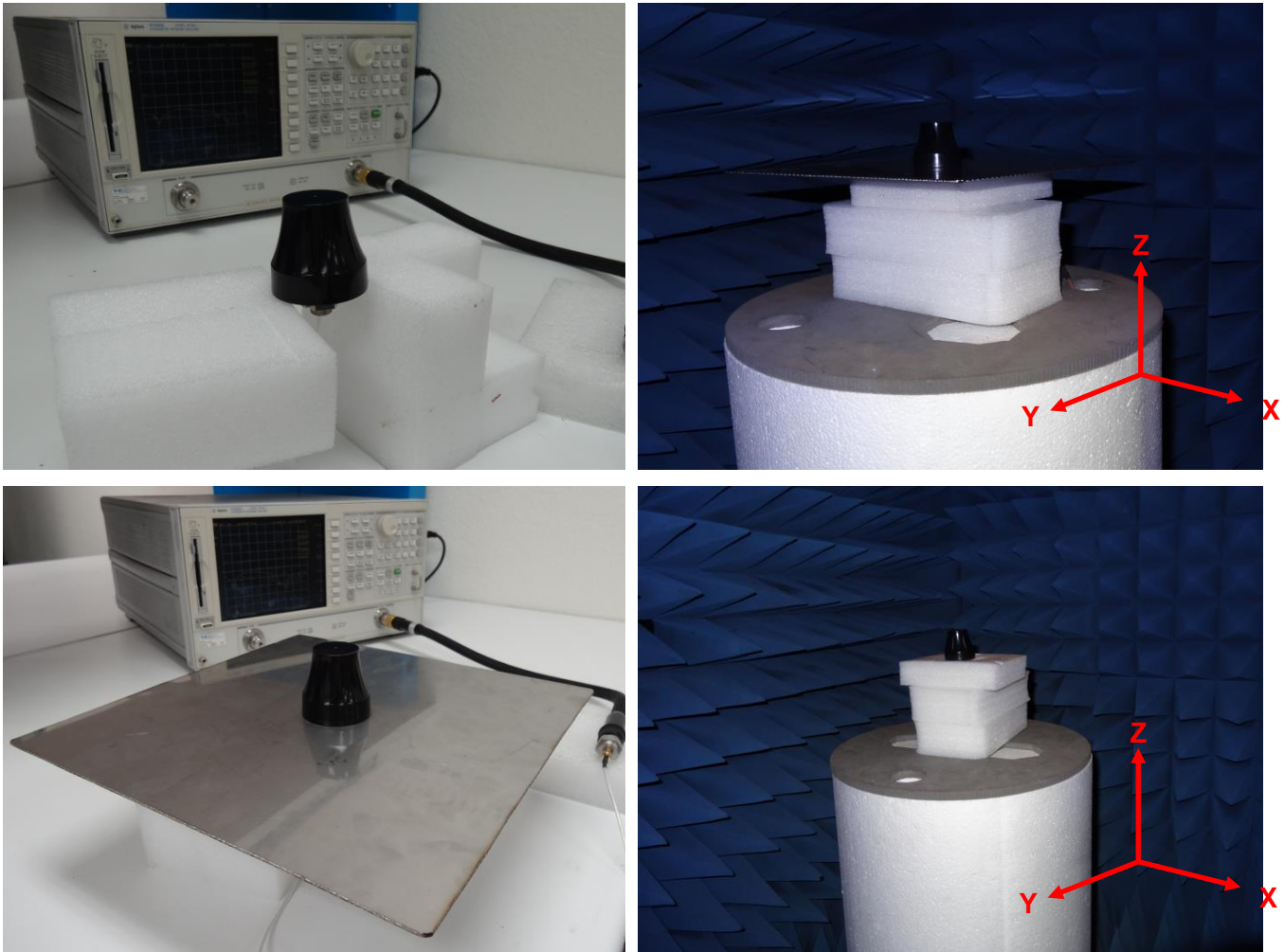

Figure 1. Impedance Test Setup of G30 Antenna in Free Space, 30cmx30cm metal plate (left hand) and peak gain, average gain, efficiency and radiation pattern measurements (right hand)

3. Antenna Parameters

3.1 Return Loss

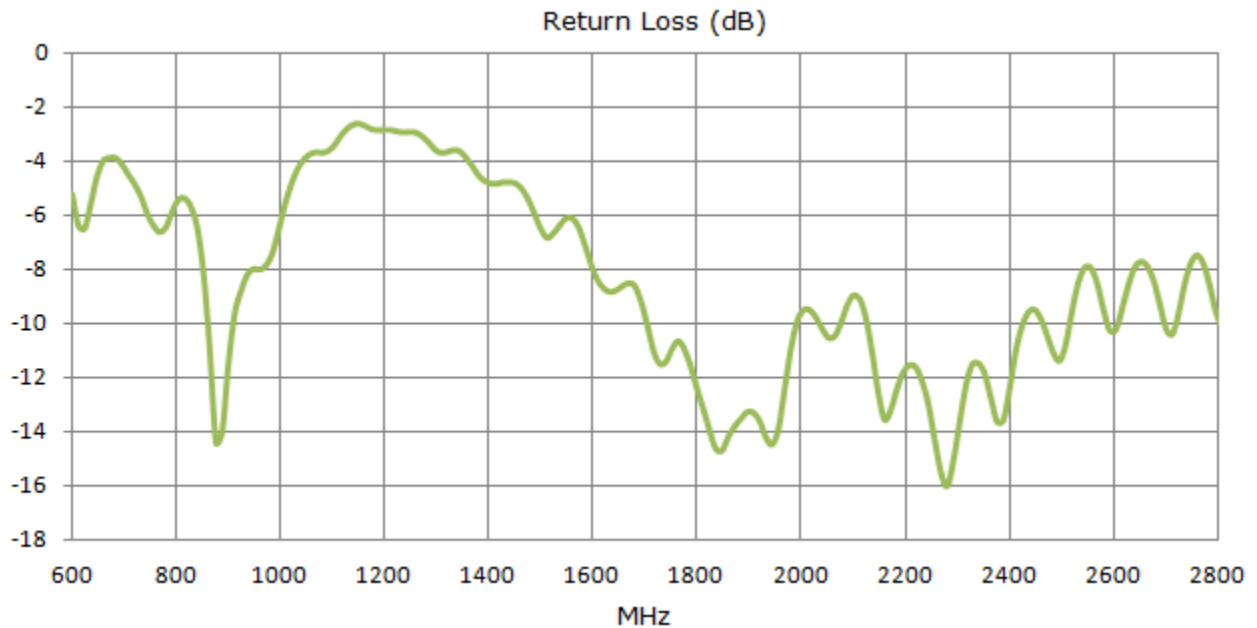

Figure 2. Return loss of G30 Antenna in Free Space

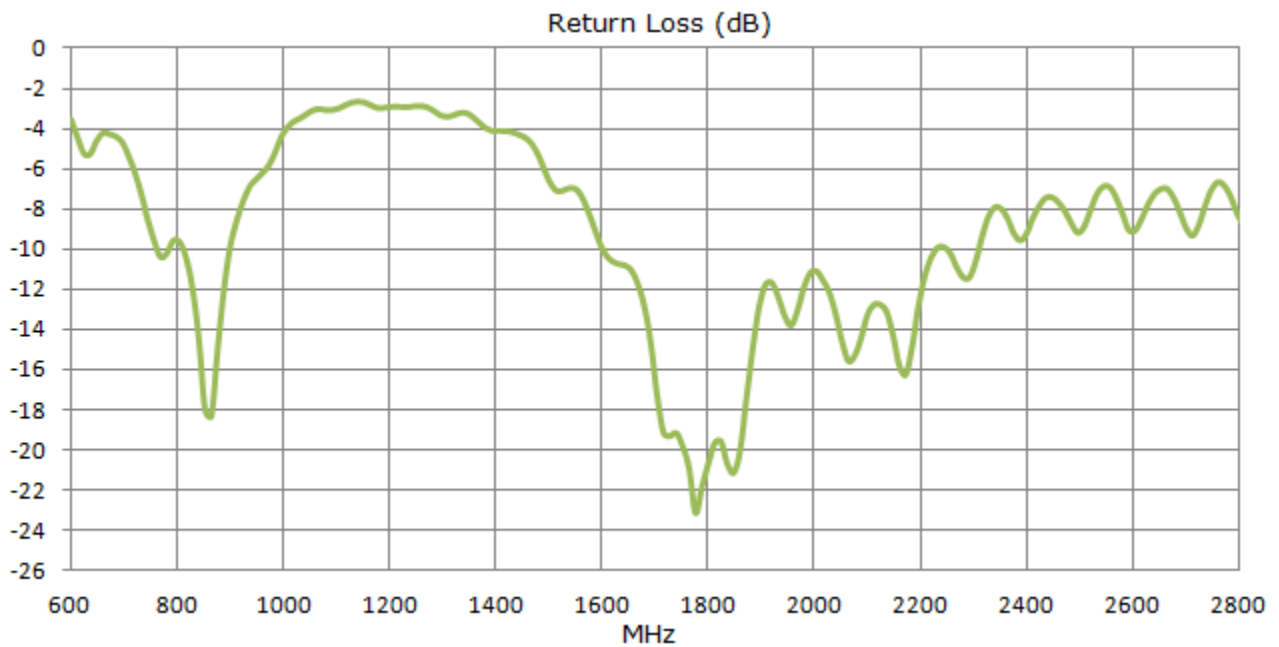

Figure 3. Return Loss of G30 Antenna on 30x30cm metal

3.2 VSWR

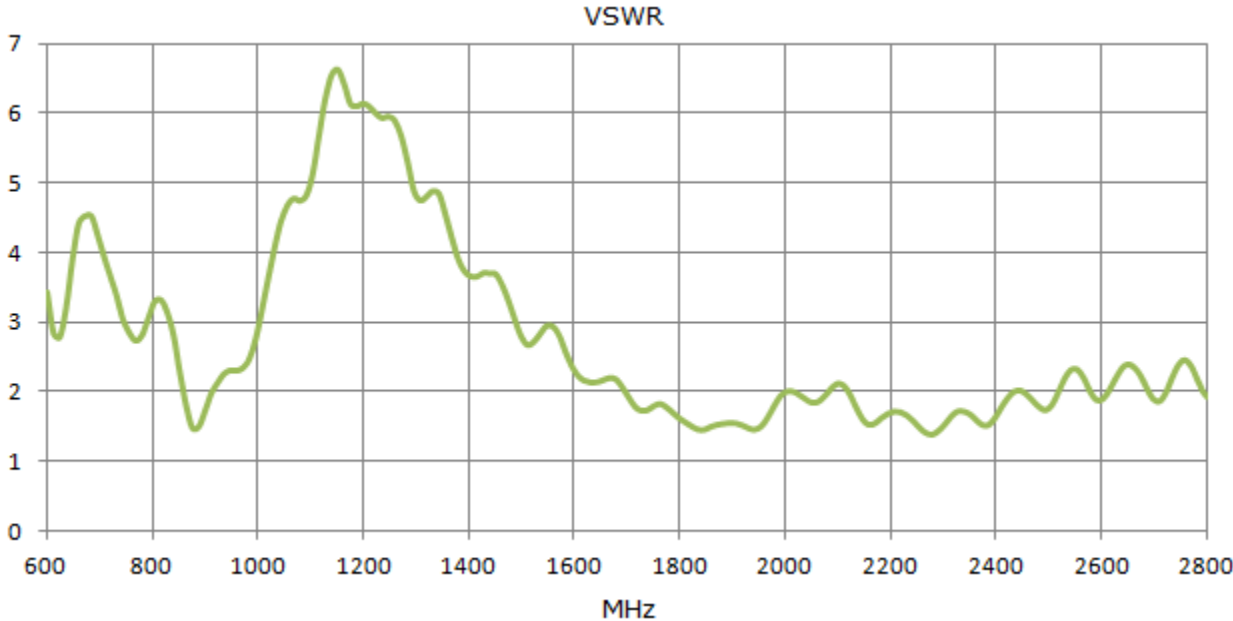

Figure 4. VSWR of G30 Antenna in Free Space

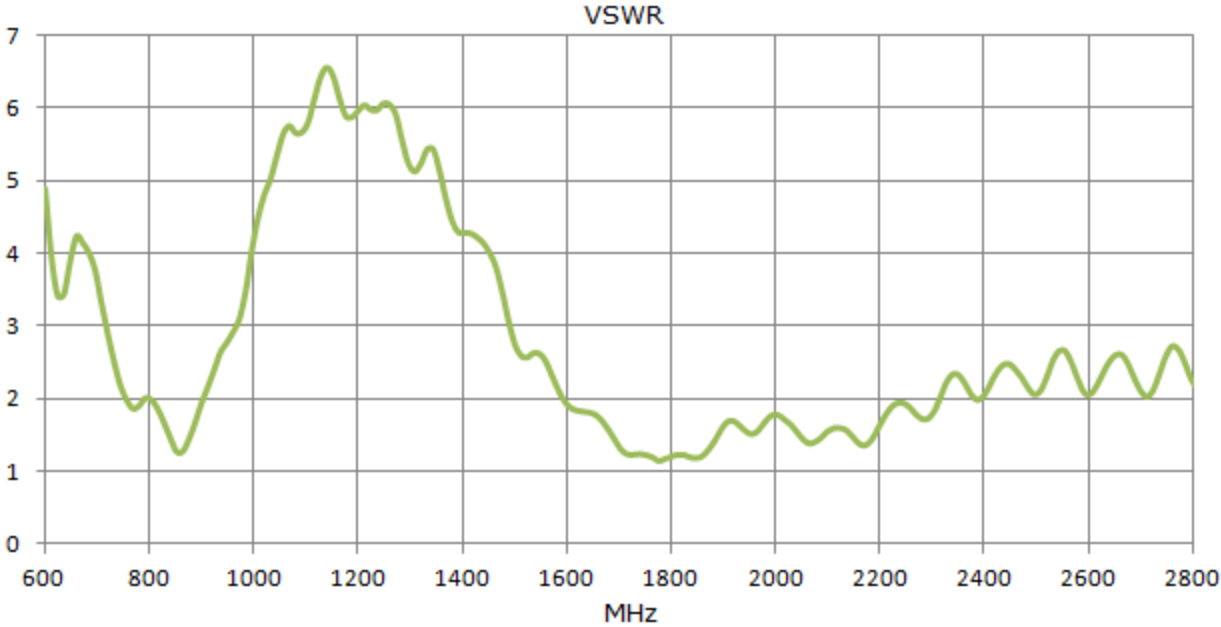

Figure 5. VSWR of G30 Antenna on 30x30cm metal

3.3 Efficiency

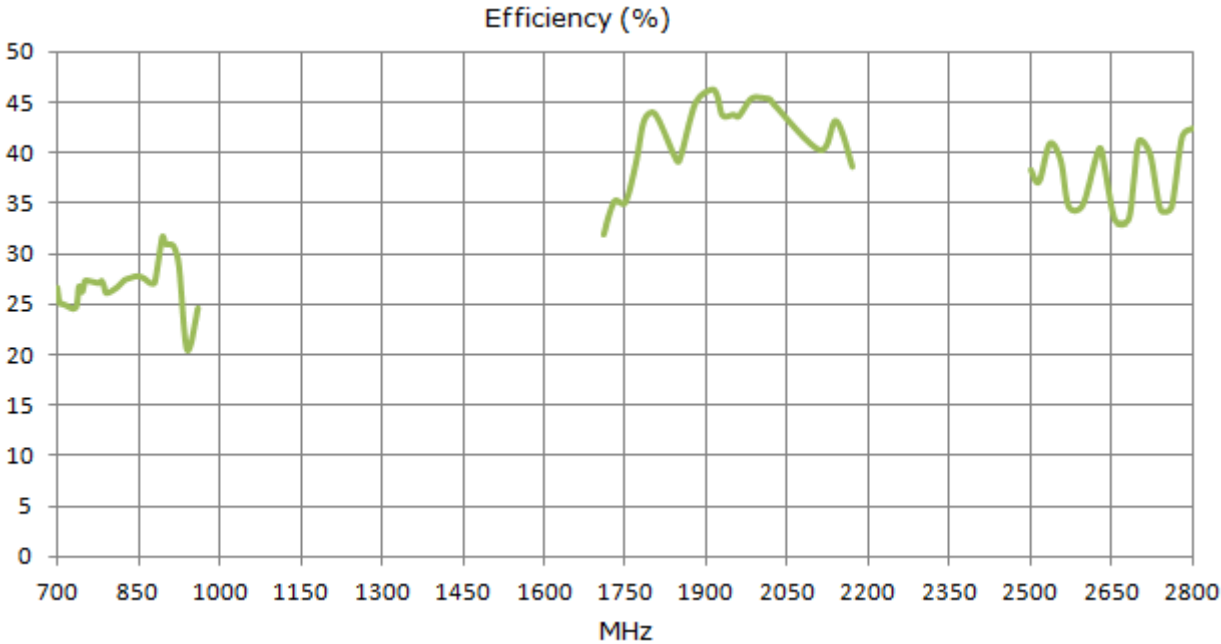

Figure 6. Efficiency of G30 Antenna in Free Space

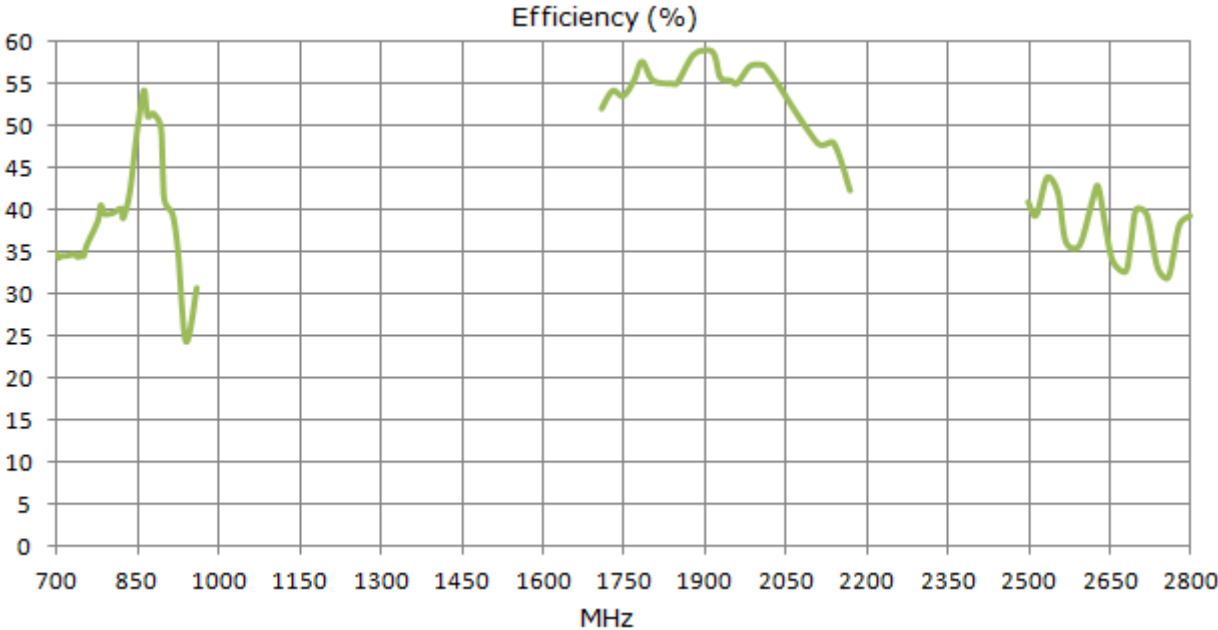

Figure 7. Efficiency of G30 Antenna on 30x30cm metal

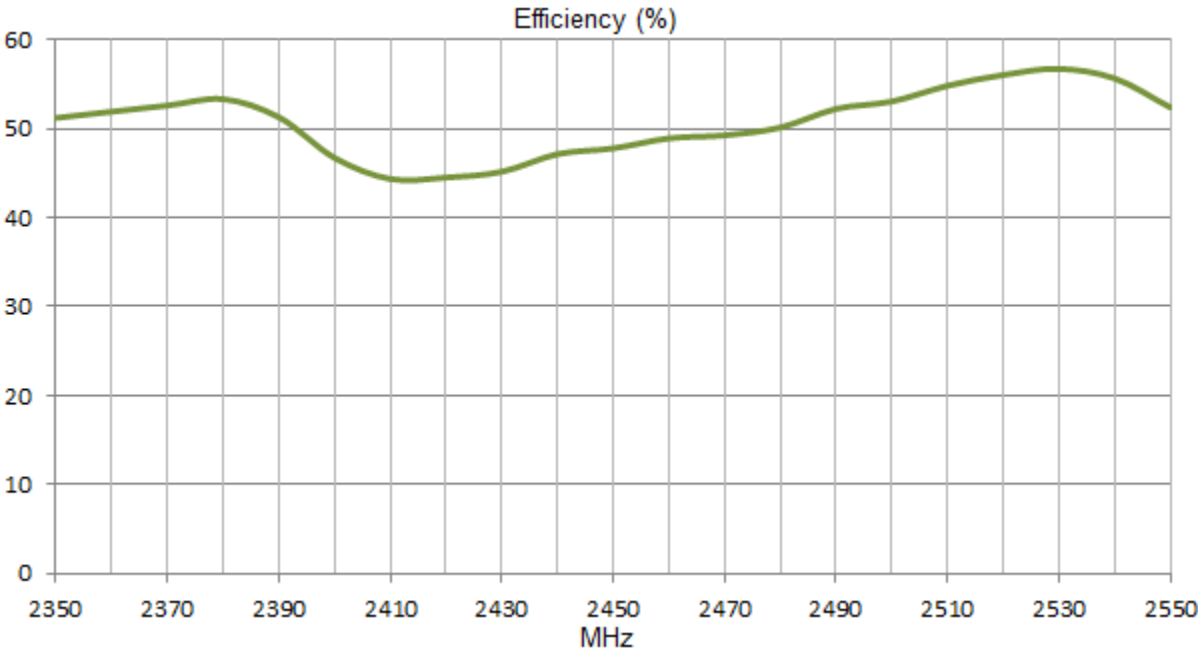

Figure 8. Efficiency of G30 Antenna at 2.4 GHz in Free Space.

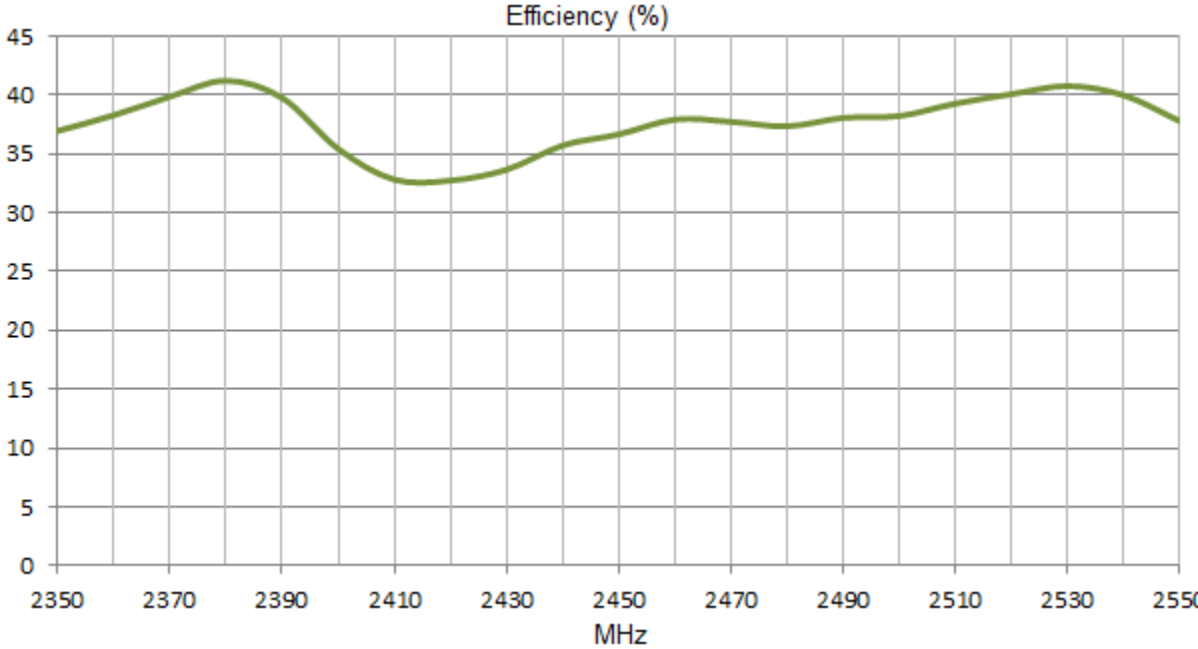

Figure 9. Efficiency of G30 Antenna at 2.4 GHz on metal plate 30x30 cm.

3.4. Peak Gain

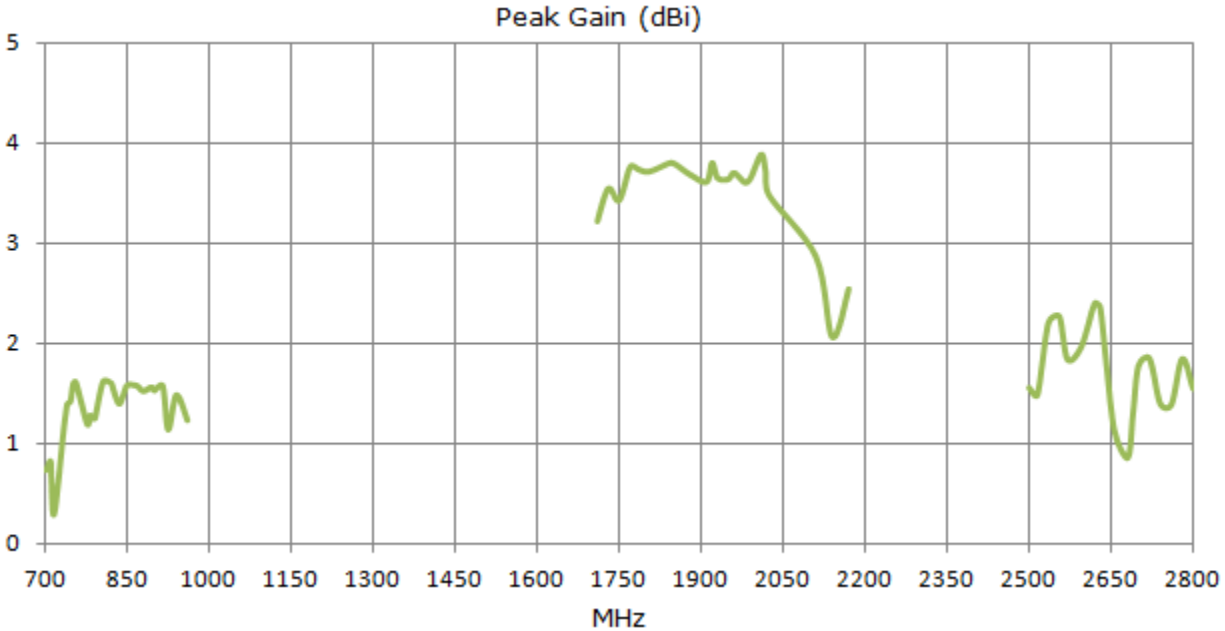

Figure 10. Peak Gain of G30 Antenna in Free Space

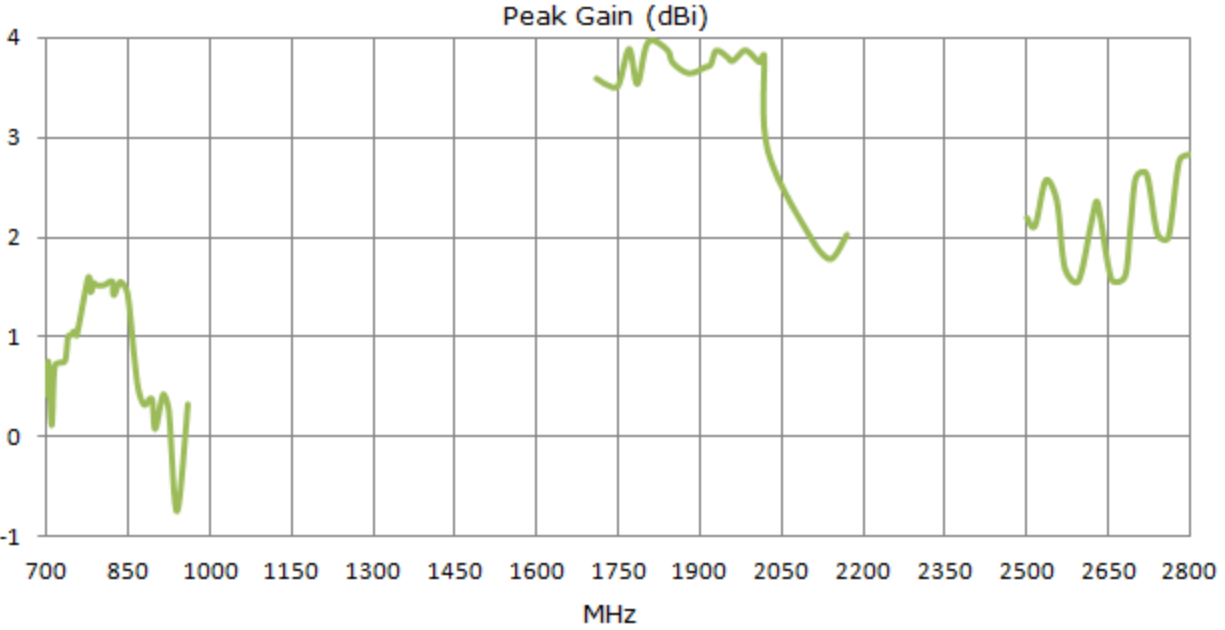

Figure 11. Peak Gain of G30 Antenna on 30x30cm metal

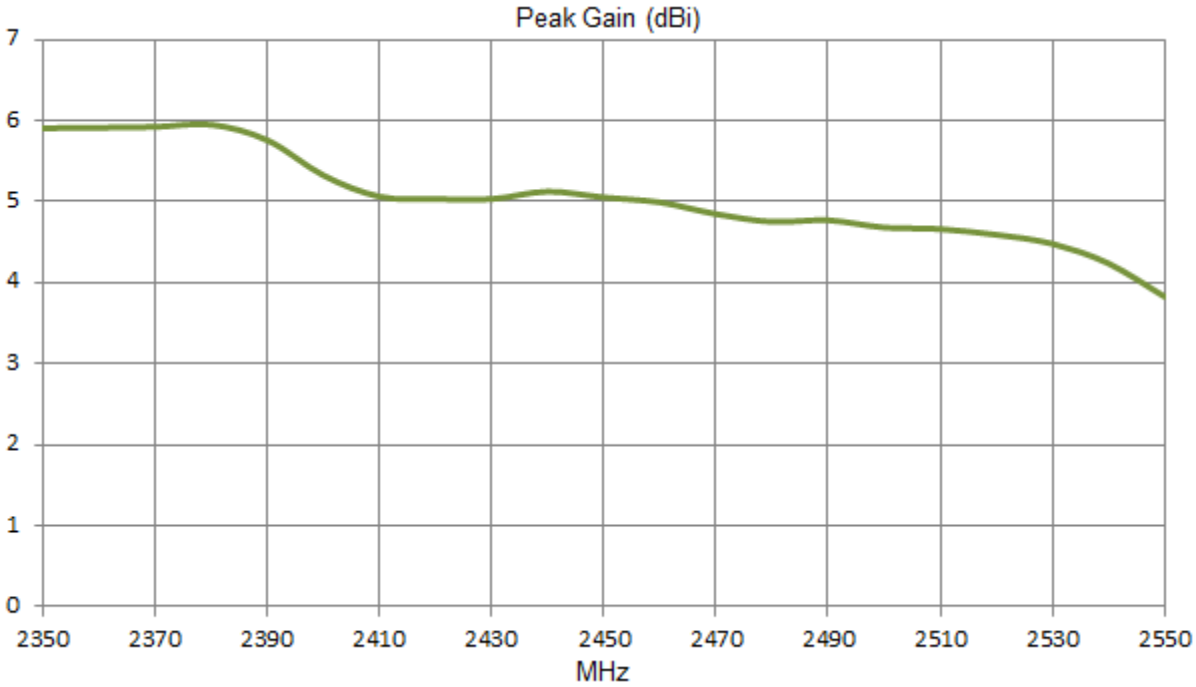

Figure 12. Peak Gain of G30 Antenna at 2.4 GHz in Free Space.

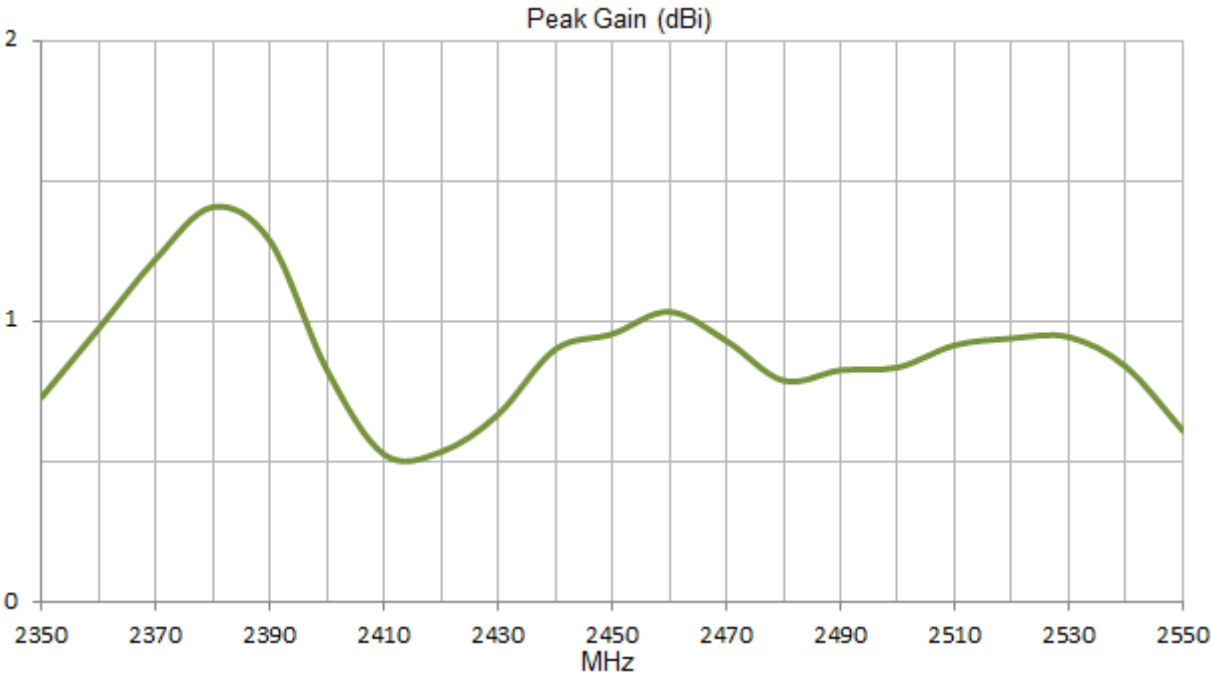

Figure 13. Peak Gain of G30 Antenna at 2.4 GHz on metal plate.

3.5 Average Gain

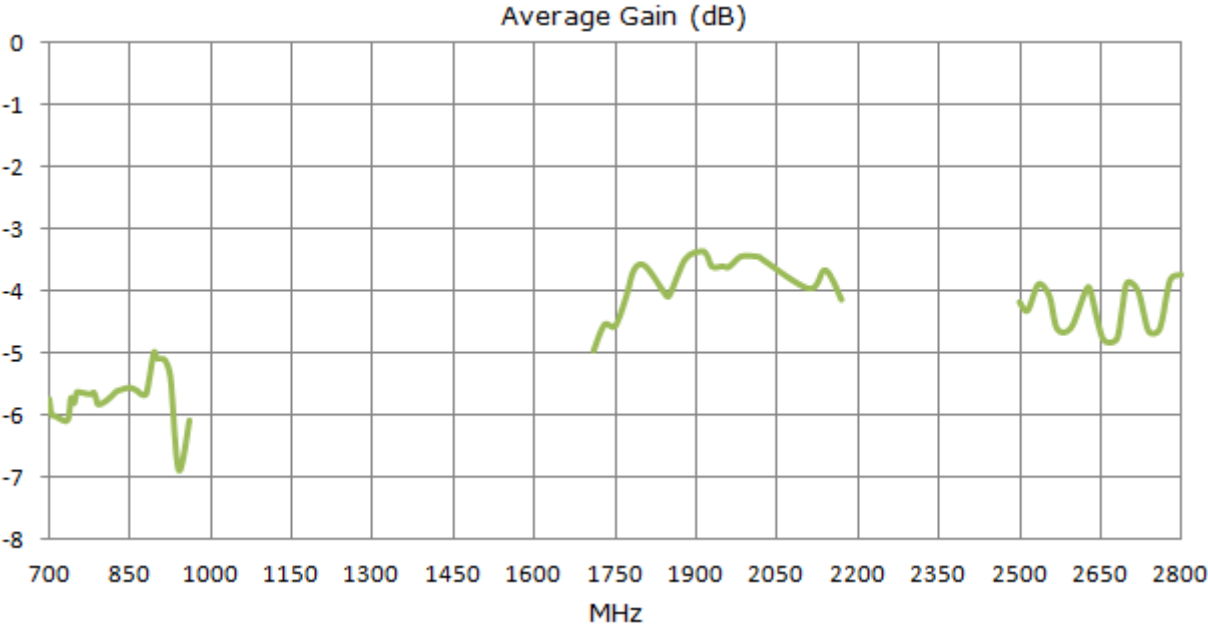

Figure 14. Average Gain of G30 Antenna in Free Space

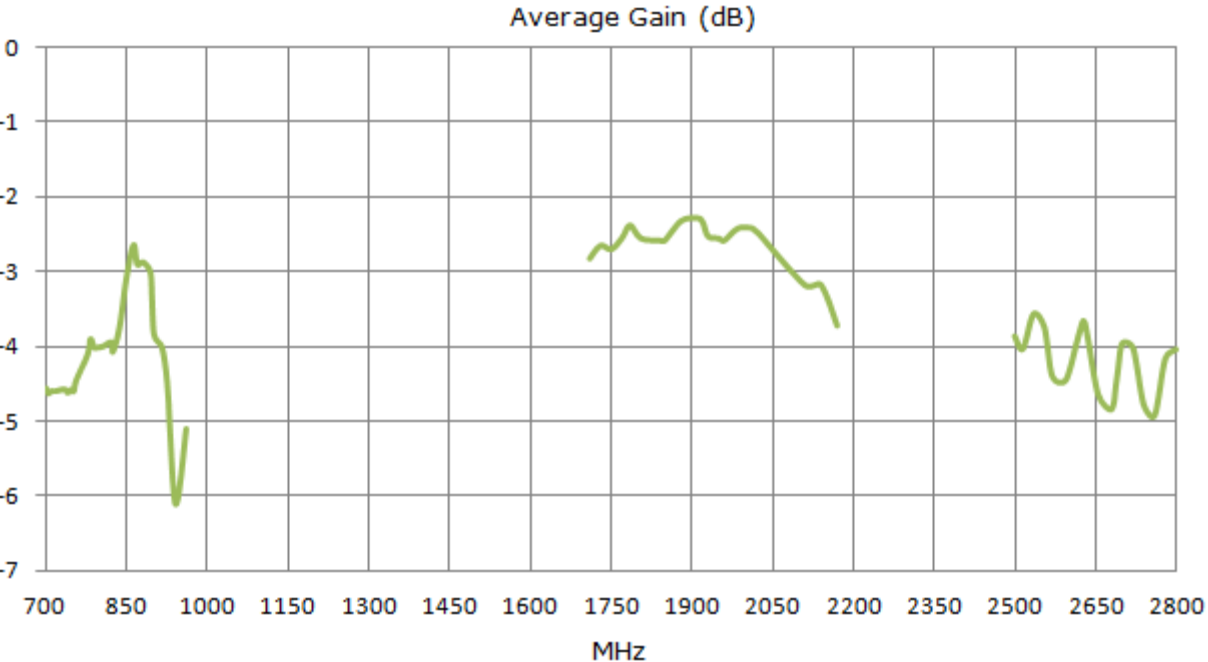

Figure 15. Average Gain of G30 Antenna on 30*30cm metal.

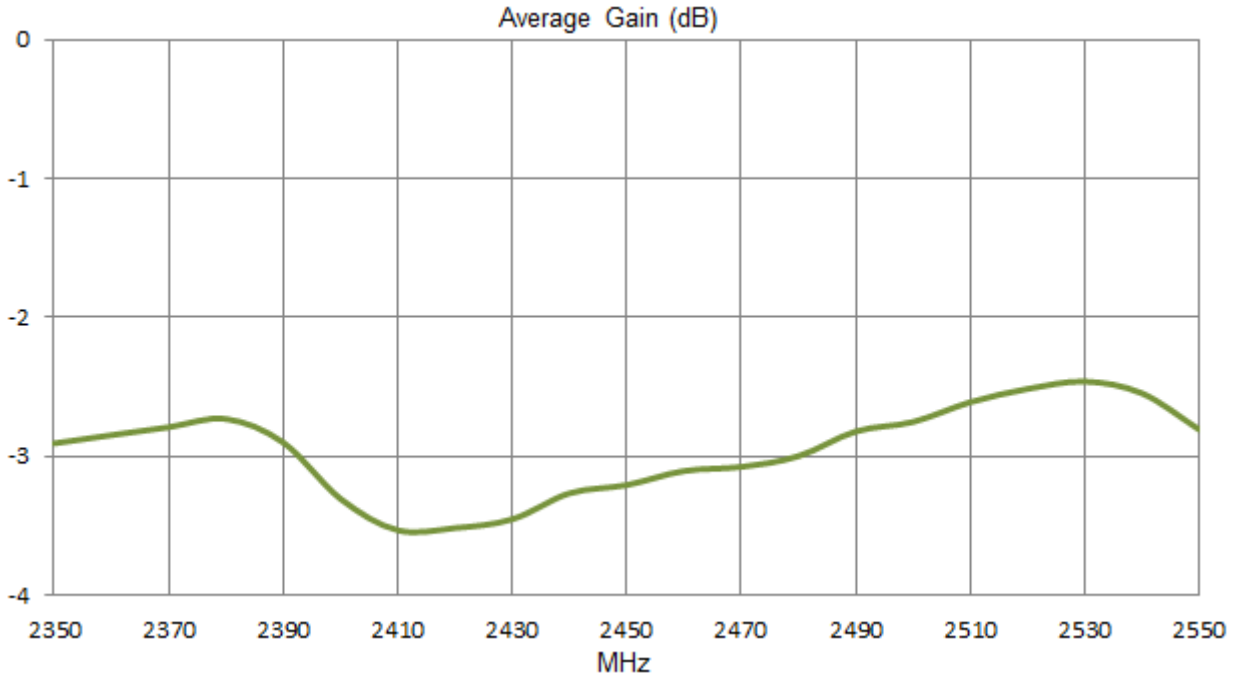

Figure 16. Average Gain of G30 Antenna at 2.4 GHz in free space.

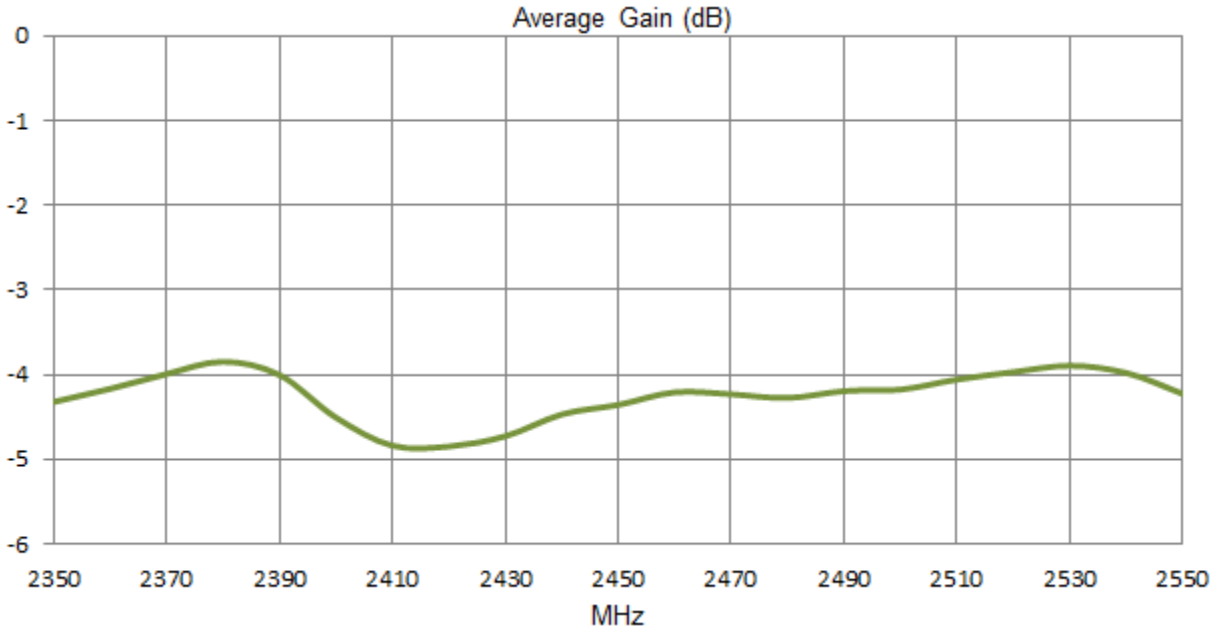

Figure 17. Average Gain of G30 Antenna at 2.4GHz on 30*30cm metal plate.

3.6 Radiation Pattern

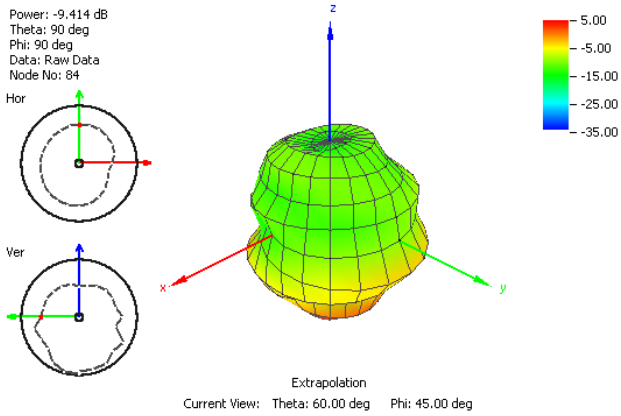

Figure 18. Radiation Pattern at 751MHz of G30 Antenna in Free Space

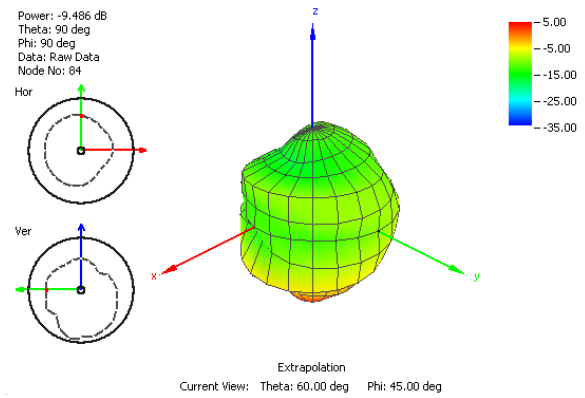

Figure 19. Radiation Pattern at 849MHz of G30 Antenna in Free Space

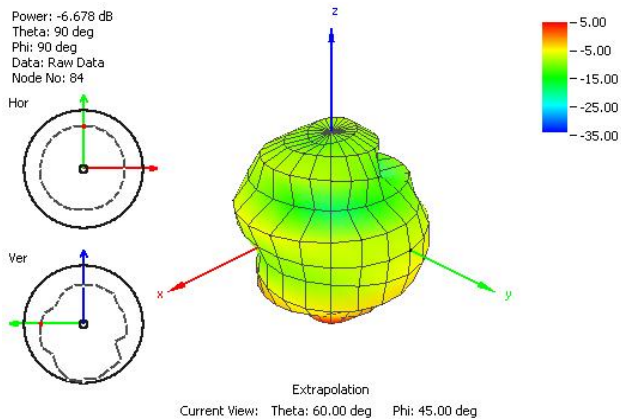

Figure 20. Radiation Pattern at 915MHz of G30 Antenna in Free Space

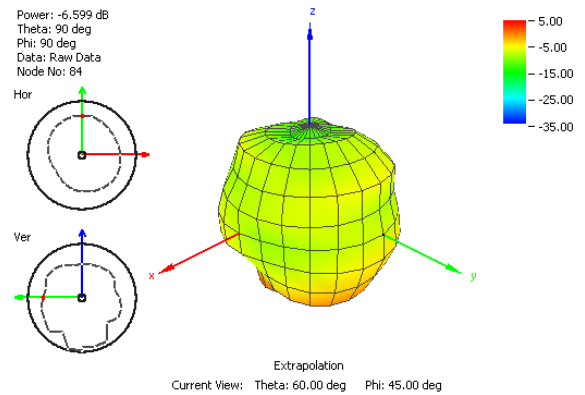

Figure 21. Radiation Pattern at 1710MHz of G30 Antenna in Free Space

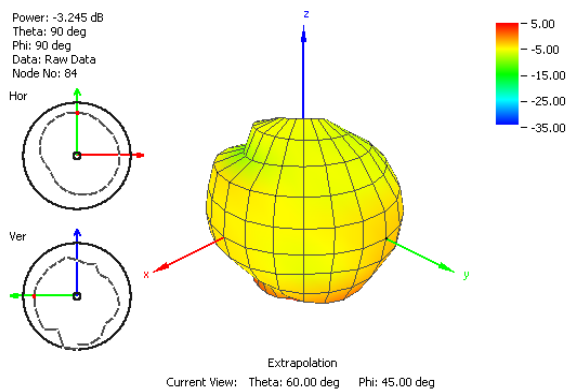

Figure 22. Radiation Pattern at 1805MHz of G30 Antenna in Free Space

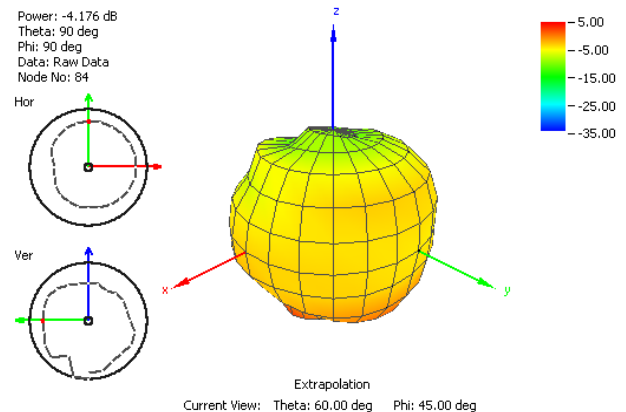

Figure 23. Radiation Pattern at 1910MHz of G30 Antenna in Free Space

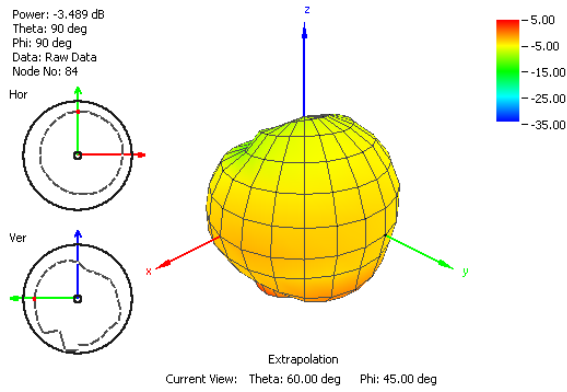

Figure 24. Radiation Pattern at 1990MHz of G30 Antenna in Free Space

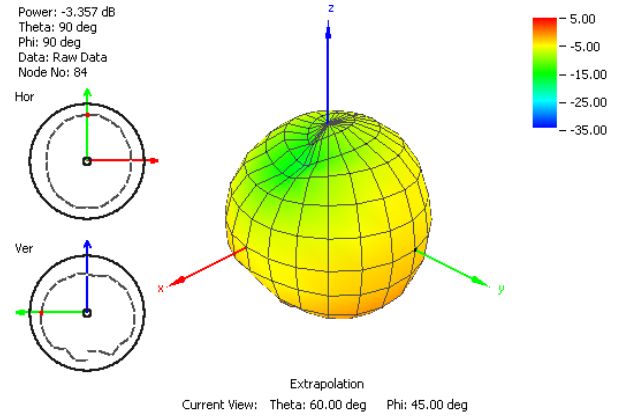

Figure 25. Radiation Pattern at 2100MHz of G30 Antenna in Free Space

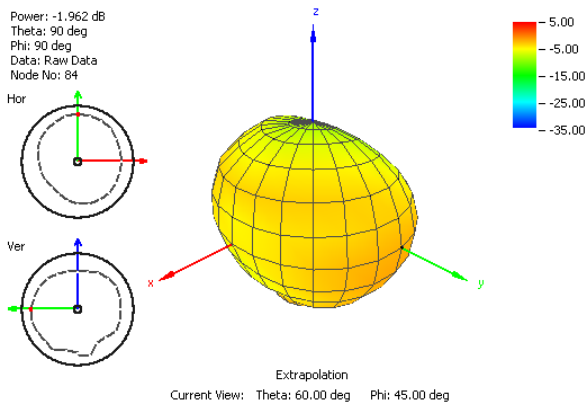

Figure 26. Radiation Pattern at 2600MHz of G30 Antenna in Free Space

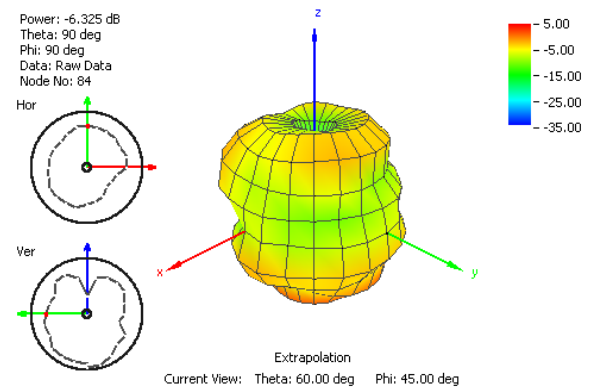

Figure 27. Radiation Pattern at 751MHz of G30 Antenna on 30*30cm metal

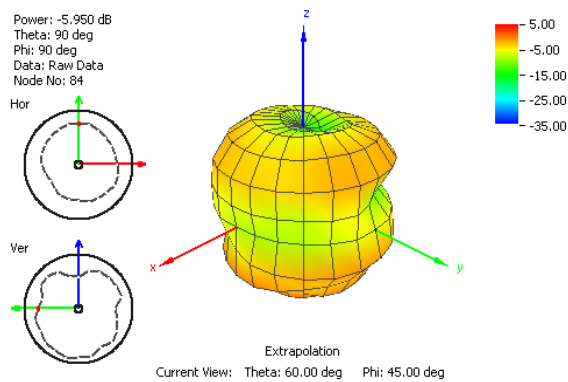

Figure 28. Radiation Pattern at 849MHz of G30 Antenna on 30*30cm metal

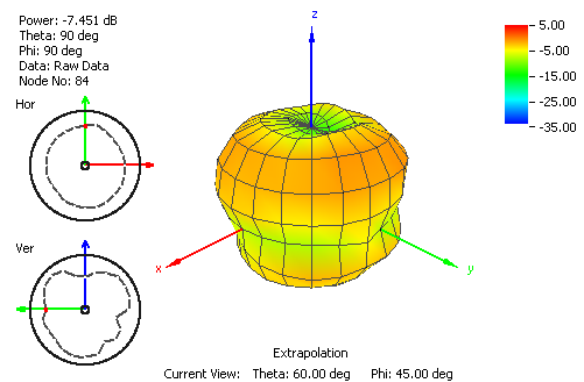

Figure 29. Radiation Pattern at 915MHz of G30 Antenna on 30*30cm metal.

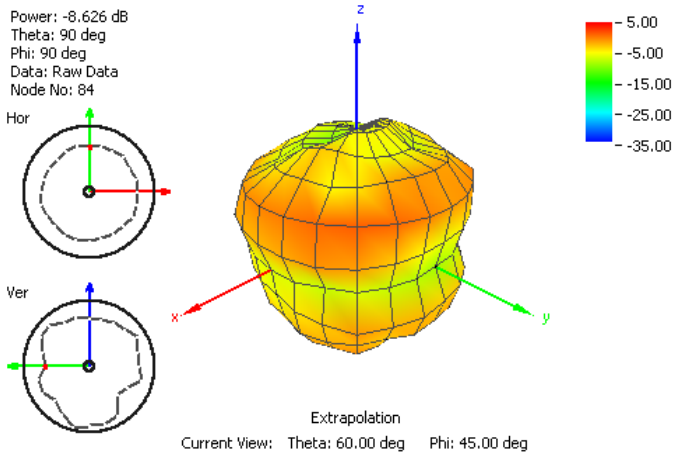

Figure 30. Radiation Pattern at 1710MHz of G30 Antenna on 30*30cm metal.

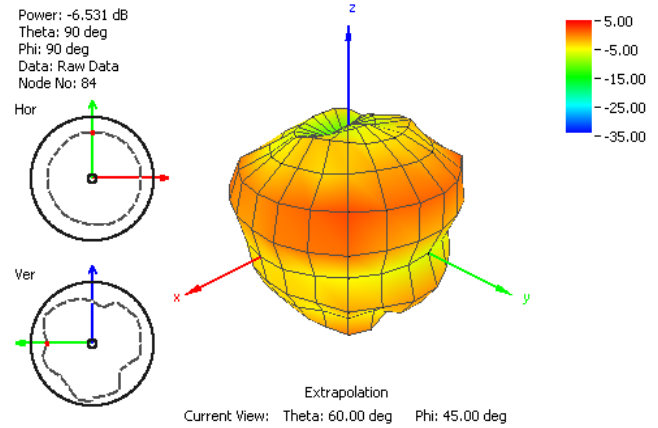

Figure 31. Radiation Pattern at 1805MHz of G30 Antenna on 30*30cm metal.

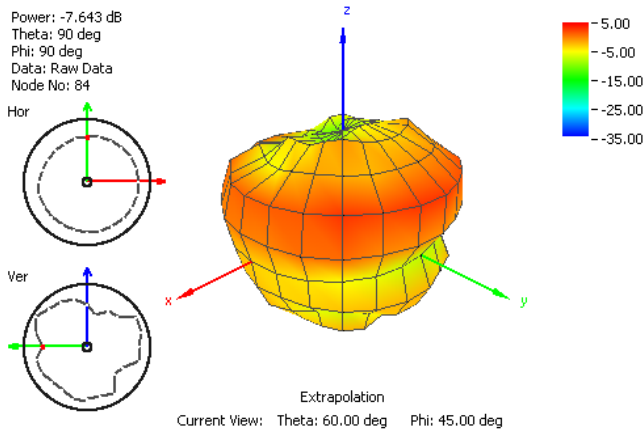

Figure 32. Radiation Pattern at 1910MHz of G30 Antenna on 30*30cm metal

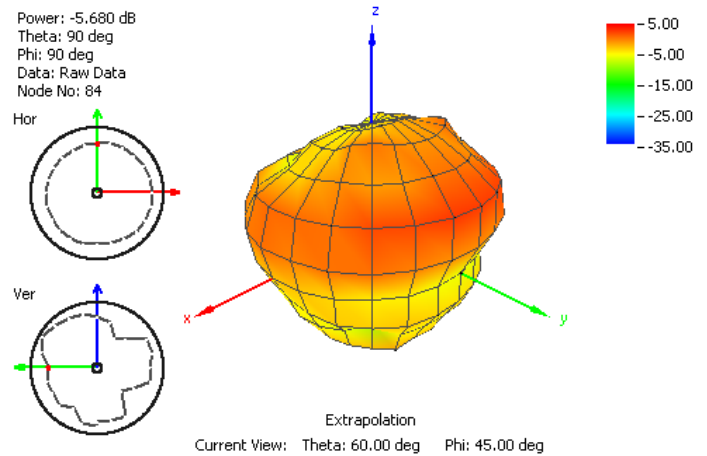

Figure 33. Radiation Pattern at 1990MHz of G30 Antenna on 30*30cm metal.

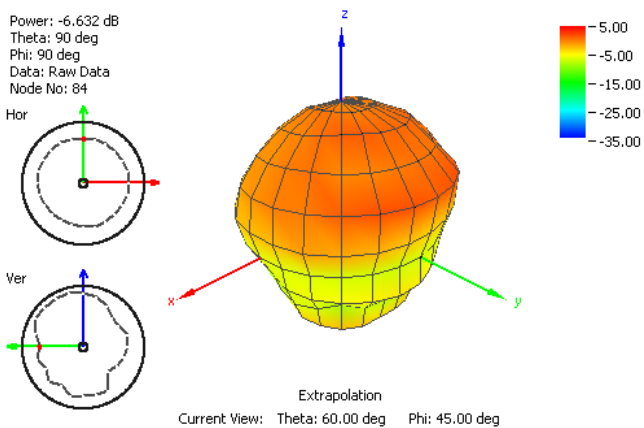

Figure 34. Radiation Pattern at 2110MHz of G30 Antenna on 30*30cm metal.

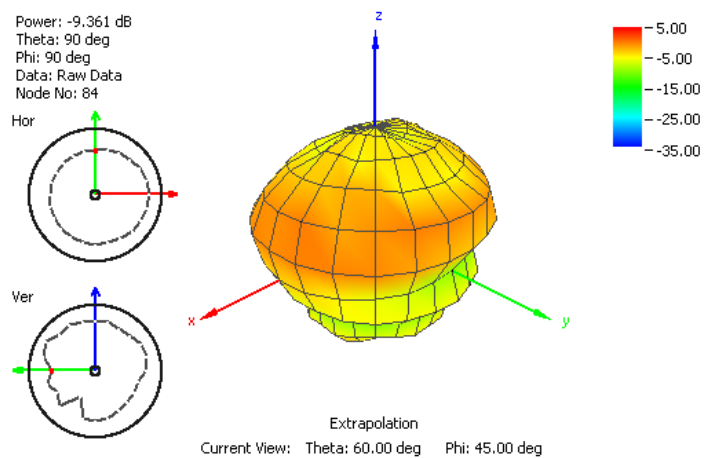

Figure 35. Radiation Pattern at 2595MHz of G30 Antenna on 30*30cm metal.

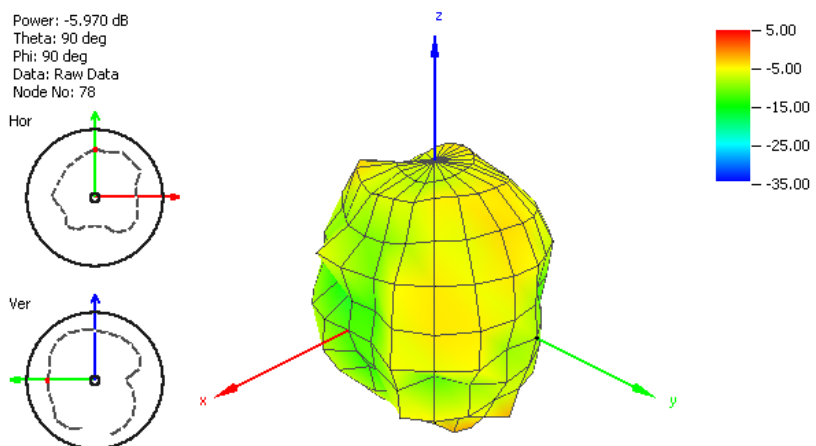

Figure 36. Radiation Pattern at 2400MHz of G30 Antenna on 30*30cm metal plate.

4 Mechanical Drawing (Unit: mm)

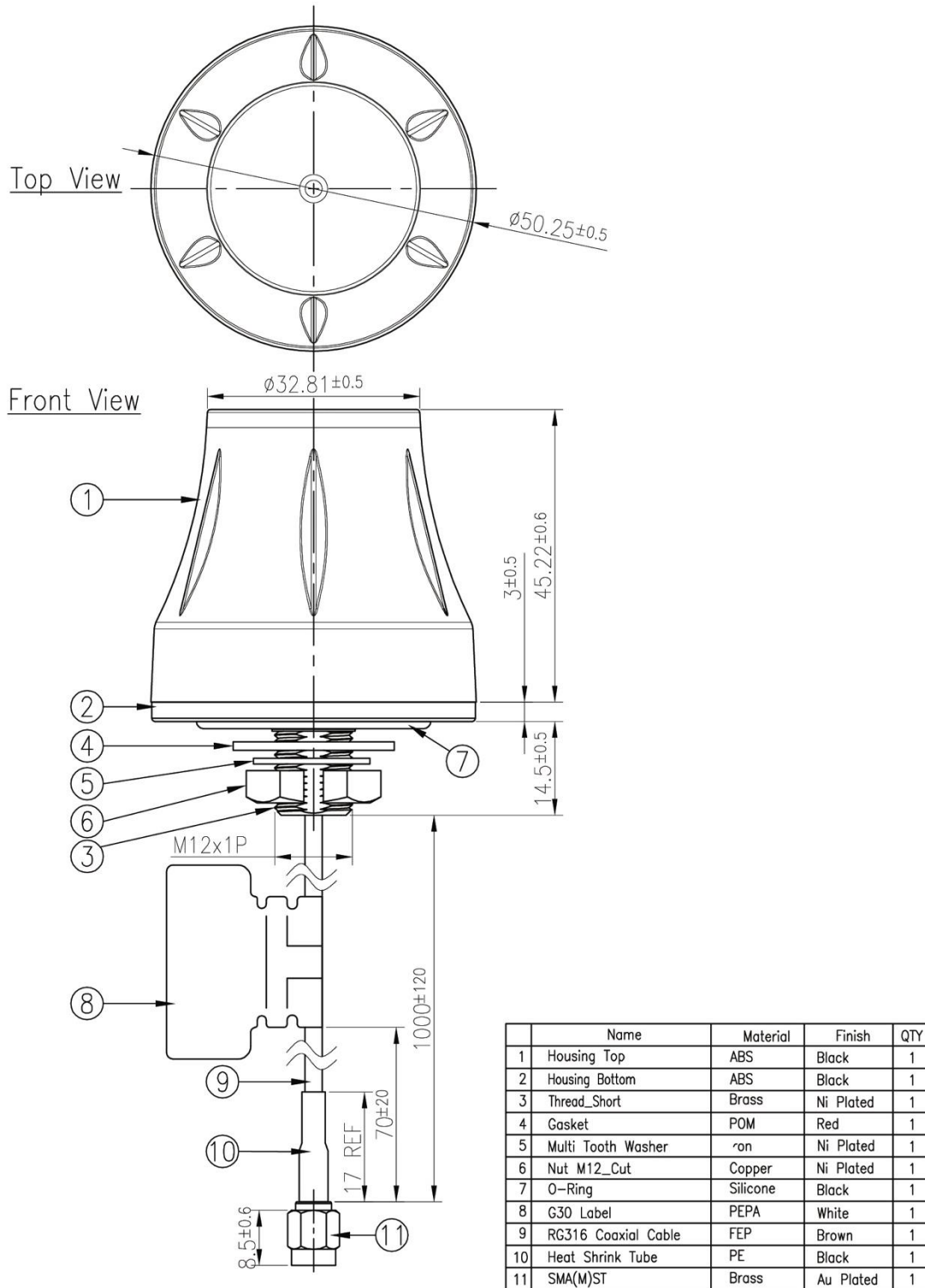
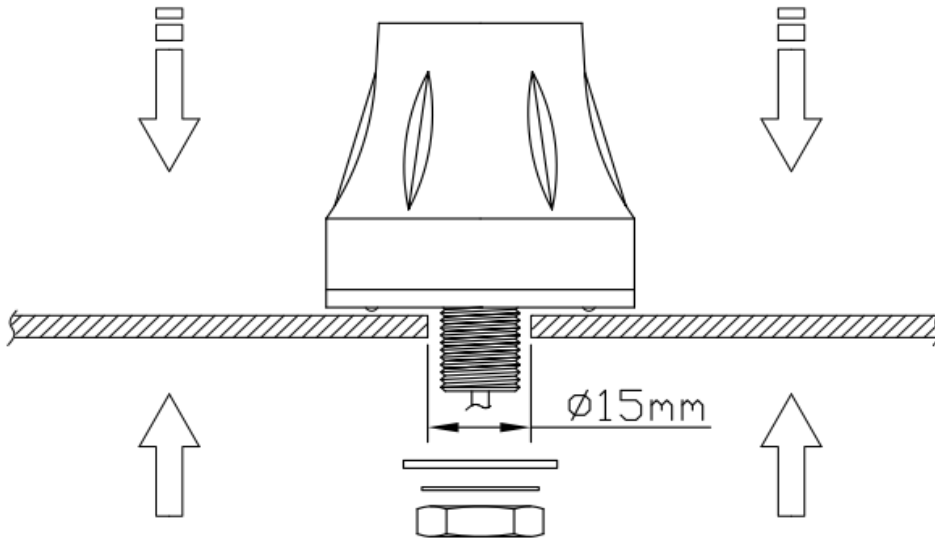

Figure 37. Mechanical Drawing of the G30 Antenna

5 Installation



Recommended torque for mounting is 2.94N.m

Maximum torque for mounting is 3.92 N.m

6 Packaging

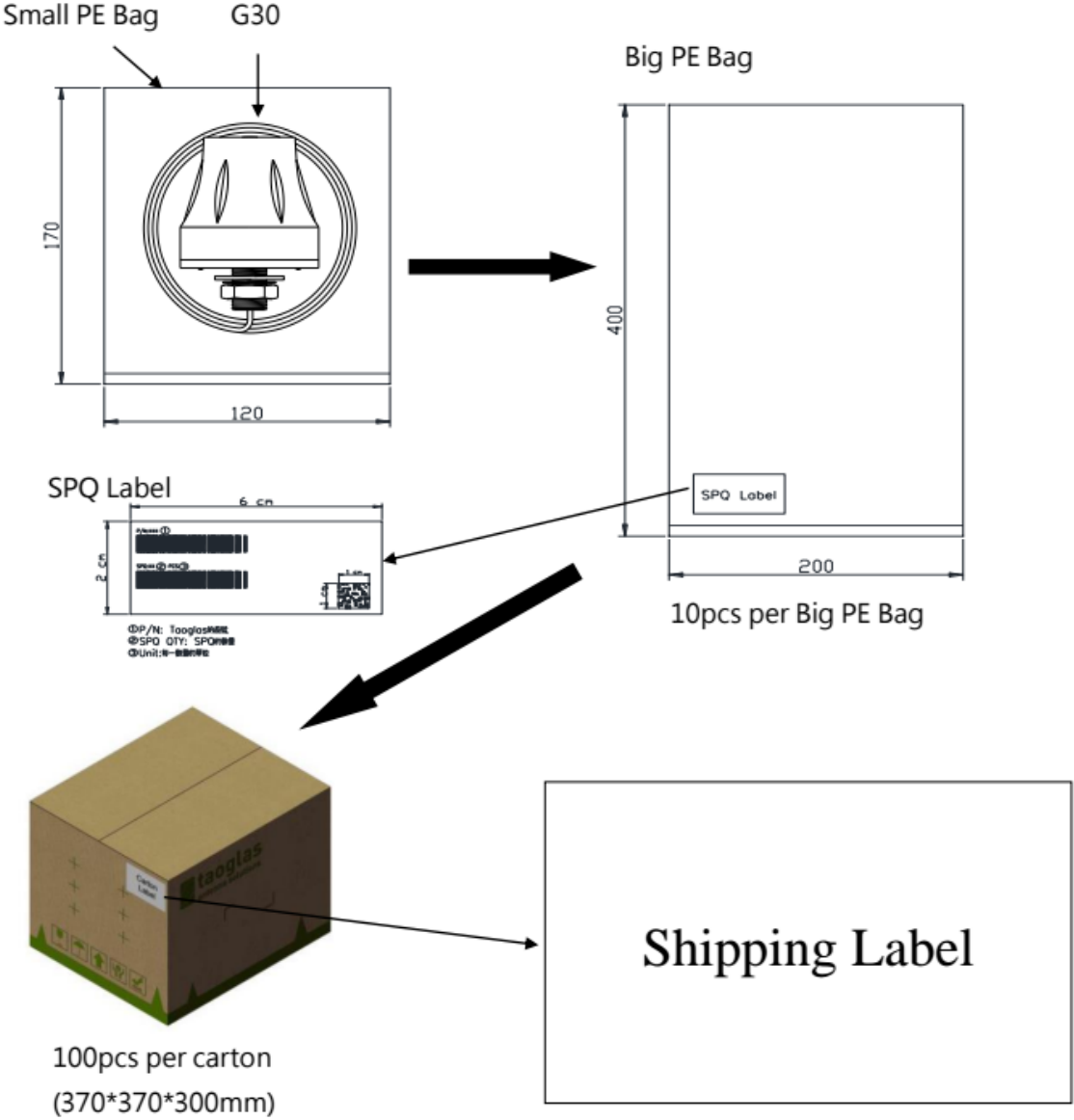

Taoglas makes no warranties based on the accuracy or completeness of the contents of this document and reserves the right to make changes to specifications and product descriptions at any time without notice. Taoglas reserves all rights to this document and the information contained herein.

Reproduction, use or disclosure to third parties without express permission is strictly prohibited.

© Taoglas