



FM260

Impulse and Frequency Multiplier for use with Incremental Encoders and Sensors

Product features:

- Universal inputs for incremental encoder signals A, B, Z or A, /A, B, /B, Z, /Z with either TTL level or RS422 format or HTL level. Also suitable for light barriers, proximity switches or NAMUR switches.
- Unit to multiply the input impulses with a proportional factor F1 and a reciprocal factor F2, both adjustable in a range of 0.005 to 9.9999
- Error-free multiplication with accurate impulse count on input and output, therefore no cumulative errors, even not with encoder vibration or frequent change of direction of rotation.
- Universal frequency output with 5 ... 30 V output level and channels A, /A, B, /B, Z, /Z
- Serial interface and USB port for communication with remote units and PC
- Frequency range 1 MHz (input and output), programmable index pulse output
- Programmable index pulse output

Version:	Description:
FM26001a/af/hk/mb/Juni08	First edition
FM26001b/hk/April09	Hint concerning shape of output signals
FM26001c_pp_11/11	Completion "encoder outputs"
Fm26001d_oi/ag/May15	<ul style="list-style-type: none"> - New chapter 3.3.1 (due to better intelligibility) - „Safety Instructions“ and “Technical Specifications“ updated - Design updated and description revised - „Disclaimer“ supplemented

Disclaimer:
<p>All contents included in this manual are protected by the terms of use and copyrights of motrona GmbH. Any reproduction, modification, usage or publication in other electronic and printed media as well as in the internet requires prior written authorization by motrona GmbH.</p>

Table of Contents

1. Safety Instructions and Responsibility	4
1.1. General Safety Instructions.....	4
1.2. Use according to the intended purpose	4
1.3. Installation.....	5
1.4. Cleaning, Maintenance and Service Notes.....	5
2. Introduction	6
3. Application Examples	7
3.1. PPR numbers which are not available with encoders	7
3.2. Fine tuning of circumference and attrition of a measuring wheel.....	7
3.3. Gearboxes with irrational or recurrent gear ratios	8
3.3.1. Important information about the waveform of the output frequency	9
4. Terminal Assignments and Connections	10
4.1. Block Diagram	11
4.2. Power Supply.....	11
4.3. Auxiliary Encoder Supply Output.....	11
4.4. Impulse Inputs for Encoders and Sensors	11
4.5. Control Inputs	12
4.6. Serial Interface	12
4.7. USB Port	12
4.8. Impulse Outputs	12
5. LCD Display and Front Keys	13

6. Keypad Operation	14
6.1. Normal Operation	14
6.2. Keypad Interlock	14
6.3. General Setup Procedure	15
6.4. Changing Parameters on the Setting Level	15
6.5. Return from the Menu, Time-Out Function	16
6.6. Reset all Parameters to Factory Default Values	16
7. Menu Structure and Parameter Description	17
7.1. Survey of Menus	17
7.2. Description of the parameters	18
7.2.1. Setting of the frequency conversion ratio	18
7.2.2. General settings	18
7.2.3. Display settings	19
7.2.4. Keypad access protection by password	19
7.2.5. Assignment of commands to the keys and the control inputs	20
7.2.6. Serial communication settings	21
7.2.7. Phase Trimming	22
8. Clarification of Command Functions	23
9. Technical Specifications	24
10. Dimensions	25
11. Appendix	26
11.1. Serial Communication Protocol	26
11.2. Installation of the USB Driver	27
11.3. Serial Code List	29
11.3.1. Parameters:	29
11.3.2. Parameters (continued)	30
11.3.3. Control Commands	30

1. Safety Instructions and Responsibility

1.1. General Safety Instructions

This operation manual is a significant component of the unit and includes important rules and hints about the installation, function and usage. Non-observance can result in damage and/or impairment of the functions to the unit or the machine or even in injury to persons using the equipment!

Please read the following instructions carefully before operating the device and observe all safety and warning instructions! Keep the manual for later use.

A pertinent qualification of the respective staff is a fundamental requirement in order to use these manual. The unit must be installed, connected and put into operation by a qualified electrician.

Liability exclusion: The manufacturer is not liable for personal injury and/or damage to property and for consequential damage, due to incorrect handling, installation and operation. Further claims, due to errors in the operation manual as well as misinterpretations are excluded from liability.

In addition the manufacturer reserve the right to modify the hardware, software or operation manual at any time and without prior notice. Therefore, there might be minor differences between the unit and the descriptions in operation manual.

The raiser respectively positioner is exclusively responsible for the safety of the system and equipment where the unit will be integrated.

During installation or maintenance all general and also all country- and application-specific safety rules and standards must be observed.

If the device is used in processes, where a failure or faulty operation could damage the system or injure persons, appropriate precautions to avoid such consequences must be taken.

1.2. Use according to the intended purpose

The unit is intended exclusively for use in industrial machines, constructions and systems. Non-conforming usage does not correspond to the provisions and lies within the sole responsibility of the user. The manufacturer is not liable for damages which has arisen through unsuitable and improper use.

Please note that device may only be installed in proper form and used in a technically perfect condition (in accordance to the Technical Specifications, see chapter [9](#)). The device is not suitable for operation in explosion-proof areas or areas which are excluded by the EN 61010-1 standard.

1.3. Installation

The device is only allowed to be installed and operated within the permissible temperature range. Please ensure an adequate ventilation and avoid all direct contact between the device and hot or aggressive gases and liquids.

Before installation or maintenance, the unit must be disconnected from all voltage-sources. Further it must be ensured that no danger can arise by touching the disconnected voltage-sources.

Devices which are supplied by AC-voltages, must be connected exclusively by switches, respectively circuit-breakers with the low voltage network. The switch or circuit-breaker must be placed as near as possible to the device and further indicated as separator.

Incoming as well as outgoing wires and wires for extra low voltages (ELV) must be separated from dangerous electrical cables (SELV circuits) by using a double resp. increased isolation.

All selected wires and isolations must be conform to the provided voltage- and temperature-ranges. Further all country- and application-specific standards, which are relevant for structure, form and quality of the wires, must be ensured. Indications about the permissible wire cross-sections for wiring are described in the Technical Specifications (see chapter [9](#)).

Before first start-up it must be ensured that all connections and wires are firmly seated and secured in the screw terminals. All (inclusively unused) terminals must be fastened by turning the relevant screws clockwise up to the stop.

Overvoltages at the connections must be limited to values in accordance to the overvoltage category II.

For placement, wiring, environmental conditions as well as shielding and earthing/grounding of the supply lines the general standards of industrial automation industry and the specific shielding instructions of the manufacturer are valid. Please find all respective hints and rules on www.motrona.com/download.html --> "[General EMC Rules for Wiring, Screening and Earthing]".

1.4. Cleaning, Maintenance and Service Notes

To clean the front of the unit please use only a slightly damp (not wet!), soft cloth. For the rear no cleaning is necessary. For an unscheduled, individual cleaning of the rear the maintenance staff or assembler is self-responsible.

During normal operation no maintenance is necessary. In case of unexpected problems, failures or malfunctions the device must be shipped for back to the manufacturer for checking, adjustment and reparation (if necessary). Unauthorized opening and repairing can have negative effects or failures to the protection-measures of the unit.

2. Introduction

The FM 260 unit has been designed for use as a programmable impulse multiplier of incremental encoder signals. Encoder impulses applied to the input will be scaled by means of two adjustable Factors, and the resulting impulse sequence will appear at the output with only a few microseconds of delay.

The output frequency f_{out} may be higher or lower than the input frequency f_{in} , depending on the factor settings. In principle the function of the unit allows conversion of any input frequency inside the specified range to any other proportional output frequency.

This unit considers every individual impulse, with consideration of the counting direction indicated by the quadrature A/B input phase. The number of generated output pulses is therefore accurate and error-free with regard to input count and Factor setting, even with vibrations and changes of the direction.

$$f_{out} = f_{in} \frac{\text{Factor 1}}{\text{Factor 2}}$$

(Factor 1 = 0,0005 - 9,9999, Factor 2 = 0,0005 – 9,9999)

The five-decade resolution of both factors provides precision scaling of the desired output with regard to the input signal.

Moreover, if applicable, a marker pulse with programmable ppr number can be generated, either with or without synchronization to an input index pulse.

Setup of the unit requires setting of the few parameters only, which may be done by means of the front keys and the LCD menu or via PC using the serial link or the USB port of the unit.

For all PC operation the operator software OS32 is suitable (included in delivery).

Some applications may require changing settings during operation (e.g. change of the input/output ratio "on the fly"). This is easily possible via serial link, via USB or by means of a PROFIBUS network (gateway PB251 needed).

The versatile impulse input of the unit can be set for use with all common standard encoders or sensors. Independent of the selected input format the output provides always a full set of the signals A, /A, B, /B and Z, /Z. The output stages are push-pull type and provide an output level of 5 – 30 volts corresponding to the remote supply voltage applied to the output drivers.



Please refer to the supplementary document section [3.3.1](#)
„Information about the signal form of the output frequency“.

3. Application Examples

3.1. PPR numbers which are not available with encoders

Some applications may require an encoder with a ppr number that is not available on the market, or which is difficult to get. In such cases the FM 260 multiplier will be able to generate your required ppr number from the output of any standard encoder.

The example shows how to simulate an encoder with the unusual number of 5431 pulses/rev. from a standard 4096 ppr encoder, just by setting Factor 1 to 0.5431 and Factor 2 to 0.4096.

This principle even allows encoder operations with non-integer ppr numbers, e.g. to make an encoder with 100.4 impulses per revolution..

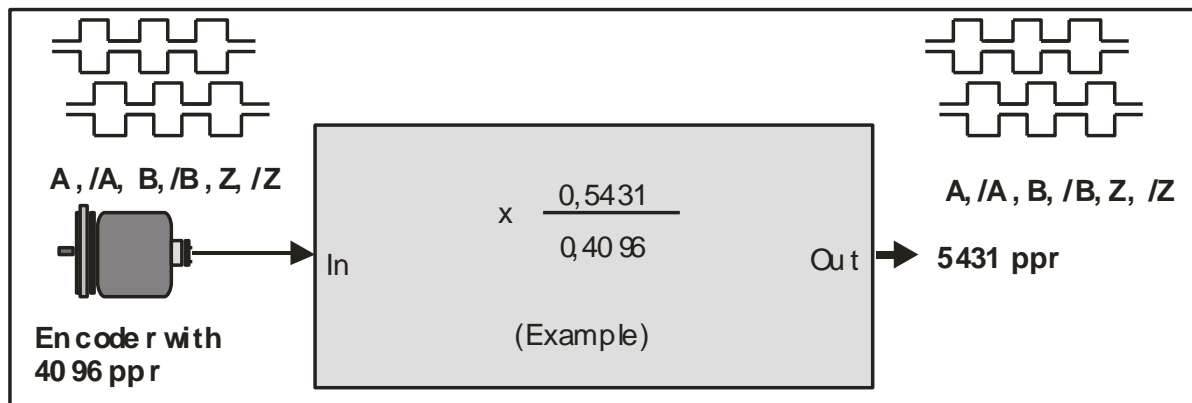

3.2. Fine tuning of circumference and attrition of a measuring wheel

Many times, in extensive production lines, only one single encoder with measuring wheel is responsible for the control of several different follower machines and controls. Where an attrition of the wheel would require readjustments in order to keep the accuracy, this would need to happen individually on every of the following machines and related controls (provided that such kind of tuning facility is available at all).

With use of a FM 260 multiplier there is an easy way of fine-tuning of the whole line in one central location only. If applicable, even remote tuning is possible via PLC and serial communication or via PROFIBUS.

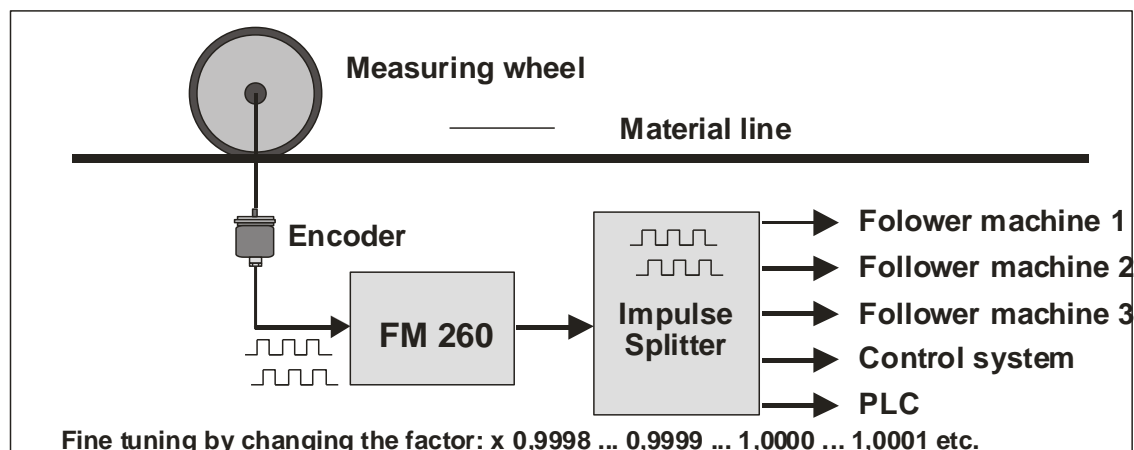

3.3. Gearboxes with irrational or recurrent gear ratios

In practical applications we often find gearings that cannot be properly expressed by a decimal number (e.g. with a pinion gear of 25 : 9 pinions the decimal expression ratio is 2.7777777.....)

This will cause problems with all position-related or angle-related applications using a decimal ratio setting. Cumulating errors will result when we set the ratio only with 3 or 4 decimal positions while the following positions remain unconsidered.

For this reason a user may be forced to mount an extra encoder on the site beyond the gear (which may be very laborious or even impossible under certain conditions), even though there may already be an encoder available on the motor site.

Since FM 260 provides a proportional and a reciprocal factor, problems with irrational gear ratios may be easily solved just by setting the real fraction values according to the number of pinions involved (i.e. 25 : 9 respectively 2.5000 : 0.9000) rather than imperfect decimal values like 2.777)

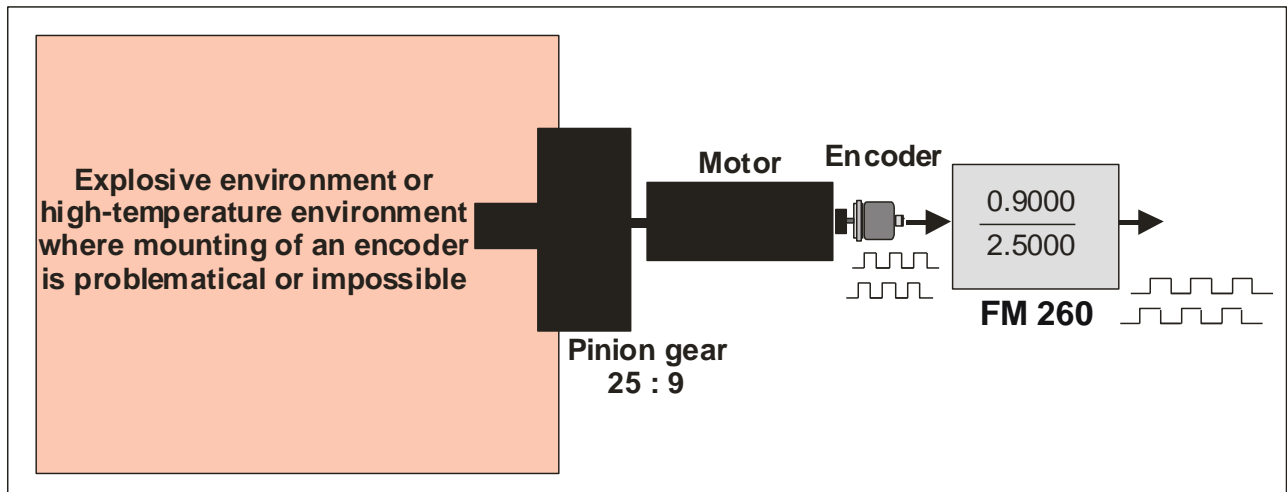

Please also refer to the supplementary document section [3.3.1](#) „Information about the signal form of the output frequency“ (see next page).

3.3.1. Important information about the waveform of the output frequency

Due to the digital synthesis of the output frequency, the FM260 delivers true pulses, but not necessarily a true frequency. This means that the pulse-pause ratio as well as the phase shift of the output channels A / B are not 1: 1 resp. do not correspond to the input channels. The incoming pulses are internally calculated by the adjusted divisor or multiplier and output as pulse packages with different intervals („gaps“) at the frequency output. The width as well as the occurrence of these gaps are dependent from the respective input frequency.

The output behavior described above can cause problems especially in **speed control applications**. For positioning tasks in highly dynamic processes the output behavior has no negative effects.

The oscillograms below will illustrate the output behavior with the aforementioned pulse packages at multiplication and division of the input frequency:

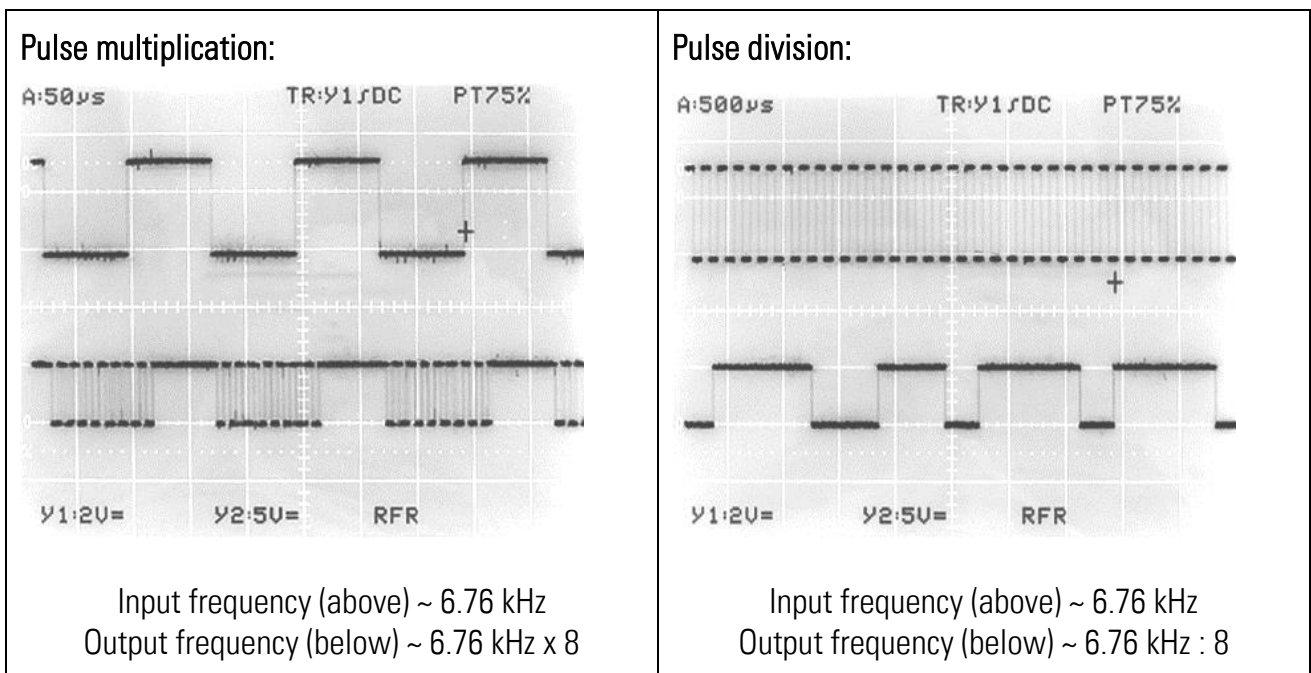

These facts however, in general, do not mean any limitations or restrictions with practical applications. Usually these signals are accepted without problems from all counters, drives, evaluation systems and other target units.

At any time it is ensured that

- the average frequency over several periods is accurately consistent with the frequency expected from the input and the ratio setting
- the phase shift is at least 45° which is more than enough for every industrial phase discriminator to operate correctly
- the number of output pulses corresponds exactly to the number of input pulses with consideration of the conversion ratio

4. Terminal Assignments and Connections

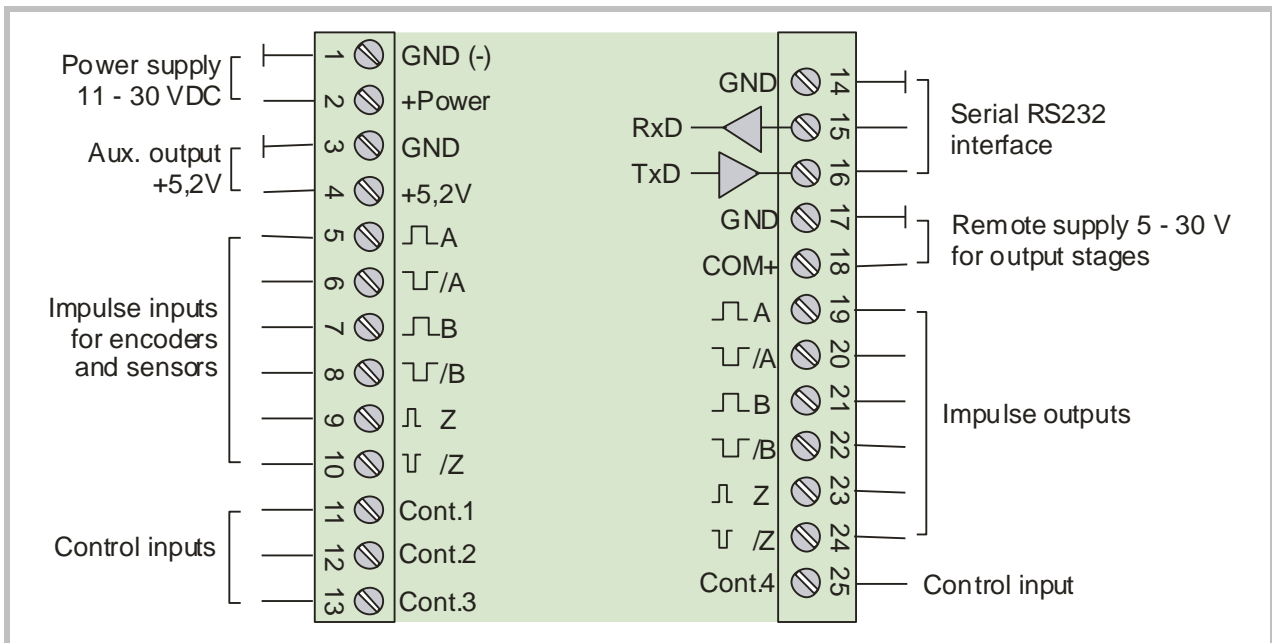

Terminal	Appellation	Function
01	GND	Minus of power supply, common GND potential
02	+Power	Plus of power supply, 11 30 volts DC
03	GND	Common GND
04	+5,2V	Auxiliary output 5,2 V / 200 mA for encoder supply
05	A	Impulse input, channel A
06	/A	Impulse input, channel /A (=A inverted)
07	B	Impulse input, channel B
08	/B	Impulse input, channel /B (=B inverted)
09	Z	Marker pulse input Z
10	/Z	Marker pulse input /Z (=Z inverted)
11	Cont. 1	Control input with programmable function
12	Cont. 2	Control input with programmable function
13	Cont. 3	Control input with programmable function
14	GND	Common GND
15	RXD	Serial RS232 interface, Receive Data (input)
16	TXD	Serial RS232 interface, Transmit Data (output)
17	GND	Common GND
18	COM+	Remote supply input for output stages (terminals 19 – 24), 5 ... 30 VDC
19	A	Impulse output, channel A
20	/A	Impulse output, channel /A (=A inverted)
21	B	Impulse output, channel B
22	/B	Impulse output, channel /B (=B inverted)
23	Z	Marker impulse output, Z
24	/Z	Marker impulse output, /Z (=Z inverted)
25	Cont. 4	Control input with programmable function

4.1. Block Diagram

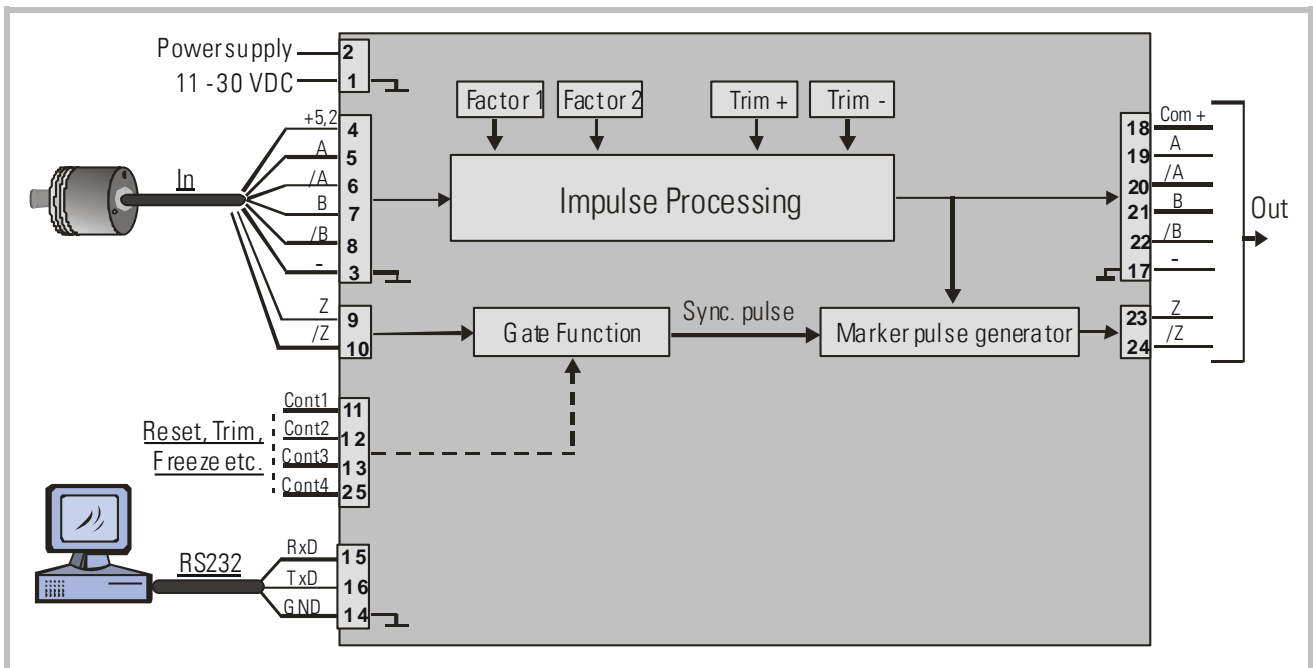

4.2. Power Supply

The units require a DC supply from 11 ... 30 VDC which must be applied to terminals 1 and 2. Depending on the input voltage level and internal states, the power consumption may vary and lies in a range of about 65 mA with a 24 VDC input (plus encoder currents taken from the auxiliary voltage output).

4.3. Auxiliary Encoder Supply Output

Terminals 3 and 4 provide an auxiliary output of +5.2 VDC / 200 mA for supply of encoders and sensors.

4.4. Impulse Inputs for Encoders and Sensors

The setup menu of the unit allows individual setting of the desired characteristics of the signal inputs. According to the application the units will accept single-channel signals (input A only with no direction information) as well as dual channel signals A/B including information of the direction of rotation. The following input formats and levels are acceptable:

- symmetric differential input with RS422 format or TTL inputs A, /A, B, /B
- asymmetric (single-ended) TTL levels (A and/or B only without inverted channels)
- HTL level 10 ... 30 VDC, alternatively differential (A, /A, B, /B) or single-ended (A and B only, without inverted channels)
- Signals from proximity switches or photocells providing HTL level (10 ... 30 V)
- NAMUR (2-wire) signals

The maximum input frequency of the unit is specified to 1 MHz.
The use of the marker pulse inputs Z, /Z is optional.

4.5. Control Inputs

The control inputs provide assignment of programmable functions like keypad-locking, change of the direction A/B or freezing of the actual output frequency etc.

The inputs require HTL level 10 – 30 V (PNP, switching to +) and the input function can be set to either "active LOW" or "active HIGH". A minimum pulse duration of 2 msec must be observed with all commands applied to the control inputs.

4.6. Serial Interface

The serial RS232 interface in general may be used

- for easy setup and commissioning of the units (with use of the OS32 operator software)
- to change settings and parameters remotely by PC or PLC during the operation
- to read out internal states and actual measuring values by PC or PLC

The subsequent drawing shows how to link the unit with a PC, using the standard 9-pin Sub-D-9 connector

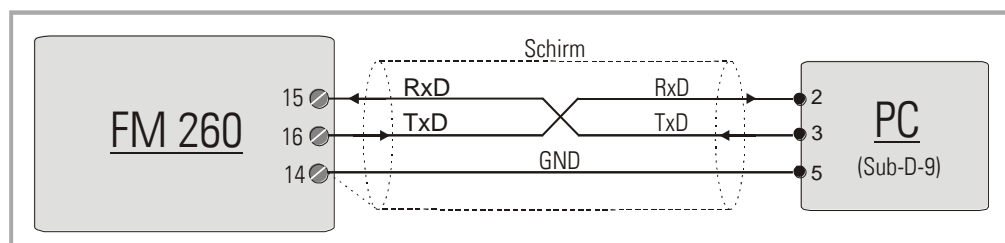

4.7. USB Port

The USB port provides exactly the same range of function as the serial interface. For USB connection you need a standard USB cable with a "Mini 5-pin" type connector on one site. Before using the USB port it is necessary to install the driver software on the operator PC. This software is available from the CD included to delivery, and can also be downloaded from www.motrona.com.

The USB driver software is named **CDM 2.04.06 WHQL Certified. zip**

Please refer to the appendix chapter [11.2](#) of this manual for more details about USB driver installation.

4.8. Impulse Outputs

Screw terminals 19 – 24 always provide all of the output signals A, /A, B, /B, Z, /Z, even when you do not apply inverted signals or marker pulse information to the input.

The output level (5 - 30 volts) is determined by the external voltage applied to terminal 18 (COM+). The unit uses push-pull output stages for all channels, and the maximum output frequency is 1 MHz.



Please note that neither the input frequency nor the resulting output frequency must exceed the maximum value of 1 MHz at all times.

5. LCD Display and Front Keys

The units provide a back-lit LCD display with 2 lines at 16 characters each, and four keys for setup and command control.

During the setup procedure the LCD display indicates the menu with all parameter texts and the set values of the parameters.

During normal operation, the LCD display indicates the following information:

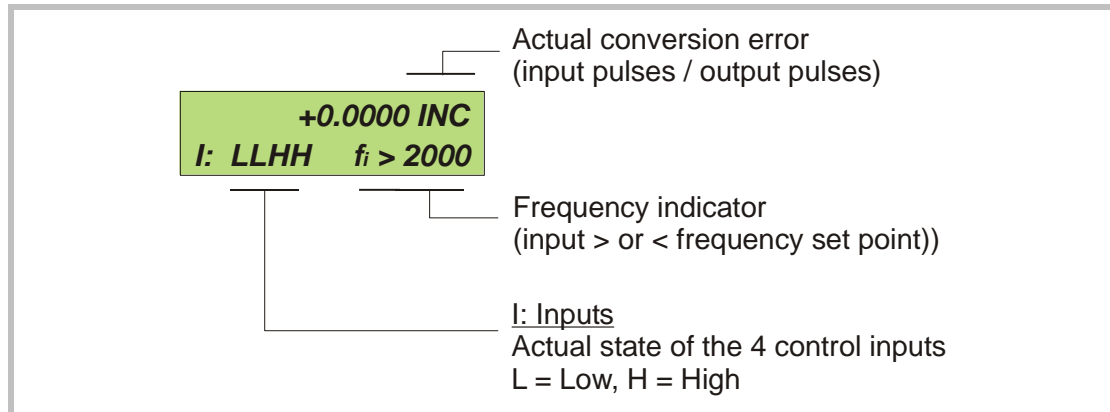

6. Keypad Operation

A summary of all parameters and a detailed description of parameter functions are available in chapter [7](#).

For all operation, the units provide four front keys which subsequently will be named as shown below:

			
PROG	UP	DOWN	ENTER

The key functions depend on the actual operating state of the units. Basically we have to distinguish between **Normal Operation** and **Setup Operation**

6.1. Normal Operation

While in normal operation state, the units process the input frequency to an output frequency according to the selected operational parameters and settings. Each of the front keys provides the command functions as attached to it upon setup in the "Command Menu"

6.2. Keypad Interlock

There is a 3-stage conception to protect the keys against unauthorized changes of the configuration respectively against activation of commands.

Stage	Protected Range	Protection by	Key Operations	
			Change of Parameters	Commands
1	---	---	permitted	permitted
2	Menu	Password upon activation of menu	Protection of selectable parts of the menu via password	permitted
3	Keyboard	Hardware-Latch 1	interlocked	permitted
		Hardware Latch 2	All functions interlocked	

The "Key Pad" menu allows to define an individual password for each group of parameters. This function can be used to provide individual access rights to different operators. Upon access to an interlocked section the unit asks for the corresponding password. If the correct password is not entered in time, the unit denies access and automatically returns to normal operation.

The hardware latch function can be activated and deactivated by one of the Control Inputs, or by means of serial access to the corresponding locking register.



Using the Hardware Latch function may accidentally cause a total locking of all functions, when the Control Inputs characteristics have been set inauspiciously.

In this exceptional case you can release the key functions again by either

- applying the correct logical state (High or Low) to the inputs
- or resetting the parameters to their default values (see section [6.6](#))
- or change the parameters being responsible for the locking by PC

6.3. General Setup Procedure

To change over from normal operation to the setup state, please keep down the PROG key for at least 2 seconds. After this the menu appears and you can select one of the menu groups.

Inside each group you can select the desired parameter and edit the setting according to need.

After this you are free to edit more parameters, or to return to normal operation.











The function of the different keys during setup is shown in the table below.

Key	Menu Level	Parameter Level	Setting Level
PROG	Save settings and return to normal operation	Return to Menu Level	Check entry, store result, then go back to Parameter Level
UP	Switch over to next menu	Select next parameter	Increment the highlighted digit or scroll the setting upwards
DOWN	Go back to previous menu	Select previous parameter	Decrement the highlighted digit or scroll the setting downwards
ENTER	Switch over to the Parameter Level of the current menu	Switch over to Setting Level	Shifts the highlighted digit one position to the left, or from utmost left to utmost right

6.4. Changing Parameters on the Setting Level

With signed parameters, the front digit can only be changed between „+“ (positive) and „-“ (negative). The subsequent example explains how to change a parameter from originally **1024** to a new value of **250 000**.

The example assumes that you are already on the Setting Level, i.e. you have already selected the corresponding parameter and read its actual value on the display. Highlighted (blinking) digits are marked by background color and indicate the cursor position.

No.	Display	Key action	Comment
00	001024		The actual value 1024 is displayed, with the last digit blinking
01		 4 x	Change last digit to 0
02	001020		Shift cursor to left
03	001020	 2 x	Change highlighted digit to 0
04	001000	 2 x	Shift cursor to left by 2 positions
05	001000		Change highlighted digit to 0
06	000000		Shift cursor to left
07	000000	 5 x	Change highlighted digit to 5
08	050000		Shift cursor to left
09	050000	 2 x	Change highlighted digit to 2
10	250000		Save new setting and return to Parameter Level



6.5. Return from the Menu, Time-Out Function

At any time the PROG key changes the Menu by one level backwards or fully back to the normal operation mode. The menu also switches automatically one level backwards, every time when for 10 seconds no key has been touched (Time-Out-Function).

6.6. Reset all Parameters to Factory Default Values

If applicable, the whole set of parameters can be reset to factory default values (e.g. because a code for the keypad interlocking has been forgotten, or because the unit does no more work correctly for reasons of bad settings). All default values are indicated in the following parameter tables.

To execute this Reset procedure, you have to take the following steps:

- Power the unit down
- Press  and  simultaneously
- Switch power on with both keys held down



Where you decide to execute this action, please be aware that all parameter settings will be lost, and you will have to repeat the whole setup procedure

7. Menu Structure and Parameter Description

All parameters are combined to groups, arranged in several menus. You must only set those parameters which are really relevant for your individual application.

7.1. Survey of Menus

This section provides an overview of the menus and their assignments to the different functions of the units. The menu names are printed bold, and associated parameters are arrayed directly under the menu names.

The menu texts in the following table are according to the presentation on the LCD display

No.:	Factor Setting	No.:	Command Setting
0	Factor 1	31	Key Up Func.
1	Factor 2	32	Key Down Func.
No.:	General Setting	33	Key Enter Func.
5	Encoder Proper	34	Input 1 Config.
6	Direction	35	Input 1 Function
7	Z-Impulse	36	Input 2 Config.
8	Burst	37	Input 2 Function
9	Input Z Config.	38	Input 3 Config.
No.:	Display Setting	39	Input 3 Function
14	Update Time	40	Input 4 Config.
15	Display Mode	41	Input 4 Function
16	Display Factor	No.:	Serial Setting
17	Display Multi.	45	Unit Number
18	Inhibit Overflow	46	Serial Baud Rate
No.:	Keypad Setting	47	Serial Format
21	Protect Factor	48	Serial Protocol
22	Protect General	49	Serial Time (s)
23	Protect Display	50	Register Code
24	Protect Keypad	No.:	Trim Setting
25	Protect Command	54	Trim Time
26	Protect Serial		
27	Protect Trim		

7.2. Description of the parameters

7.2.1. Setting of the frequency conversion ratio

Factor Settings	Range	Default
Factor 1 (proportional factor)	0.0005 ... 9.9999	1.0000
Factor 2 (reciprocal factor)	0.0005 ... 9.9999	1.0000

7.2.2. General settings

General Settings	Range	Default
Encoder Proper (properties of the input encoder) 0 A, /A, B, /B, quadrature, differential HTL or TTL or RS 422 1 A, B, quadrature, single-ended, HTL level, NPN *) 2 A, B, quadrature, single-ended, HTL level, PNP 3 A, B, quadrature, single-ended, TTL level 4 A, /A = impulse, B, /B = direction, differential HTL or TTL or RS422 5 A = impulse, B = direction, single-ended, HTL level, NPN *) 6 A = impulse, B = direction, single-ended, HTL level, PNP 7 A = impulse, B = direction, single-ended, TTL level	0 ... 7	0
Direction (definition of the A/B direction) 0 forward when A leads B 1 forward when B leads A	0 ... 1	0
Z-Impulse Number of encoder impulses between two marker pulses on output	1 ... 50,000	1,000
Burst Sets the control loop for correction of temporary conversion errors. This setting can be increased if under special conditions the unit would frequently display „Overflow“. (see also parameter „Inhibit Overflow“)	10 ... 100	20
Input Z Config *) Determines whether or not the marker pulse output should be referenced to the input marker, and which of the hardware inputs will be used for the Gate function 0 no gate function 1 a High signal on input Cont.1 and the rising edge of the input marker are used to synchronize the output marker. 2 as above, but gating by a High signal on input Cont.2 3 as above, but gating by a High signal on input Cont.3 4 as above, but gating by a High signal on input Cont.4 5 as above, but gating by a Low signal on input Cont.1 6 as above, but gating by a Low signal on input Cont.2 7 as above, but gating by a Low signal on input Cont.3 8 as above, but gating by a Low signal on input Cont.4	0 ... 8	0



When any of the control inputs (Cont.1 – Cont.4) is used for referencing of the marker pulse (Parameter „Input Z Config“ ≠ 0), no further assignment of a command will be allowed to this input (i.e. Input X Func. must be 0, see [7.2.5](#))



*) With settings HTL / NPN the input terminals are connected to the power supply voltage of the unit (+24V) via internal pull-up resistors. For this reason it is advisable to first set the encoder properties correctly, prior to connecting TTL encoders to the unit.

Setting HTL / NPN is also suitable for use with NAMUR (2-wire) proximities.
(connect the positive wire of the sensor to the input terminal and the negative wire to GND))

7.2.3. Display settings

Display Settings	Range	Default
Up-Date-Time Update time of the LCD display (sec.)	0.05 ... 1.00	0.25
Display Mode Scaling of the actual conversion error shown on the LCD display *) 0 Number of impulses that output lags input, format X.XXXX inc. 1 Number of impulses that output lags input, format XXXXX inc. 2 Conversion error converted to angular degrees, format X.XX ° Parameter „Display Factor“ must be set to the appropriate number of ppr for this 3 Error display according to user scaling, format XXXX units. $Display = \frac{Error \times DisplayMulti.}{DisplayFactor}$	0 ... 3	0
Display Factor Parameter for error scaling with modes 2 + 3	1 ... 99,999	100
Display Multi. Parameter for error scaling with mode 3	1 ... 999	100
Inhibit Overflow Sets the display mode of an overflow message 0 „Overflow“ is latched in display until cleared by a Reset command 1 „Overflow“ is displayed while an overflow situation exists and disappears automatically after catch-up of the error 2 No overflow message will appear	0 ... 2	0

7.2.4. Keypad access protection by password

Key-Pad Settings (Code for the corresponding menu)	Range	Default
Protect Menu 01 (Factor Settings)	0 = no password protection	0
Protect Menu 02 (General Settings)		0
Protect Menu 03 (Display Settings)		0
Protect Menu 04 (Key-Pad Settings)	1 ... 999.999 = password for the corresponding menu	0
Protect Menu 05 (Command Settings)		0
Protect Menu 06 (Serial Settings)		0

*) The conversion error indicates by how many impulses the output actually lags the input. Since in general any lagging error will be compensated within microseconds only, the display of conversion error and overflow message are only of interest under special conditions.

7.2.5. Assignment of commands to the keys and the control inputs

Command Setting	Range	Default
Key Up Func. (additional function of the UP key) 0 no command assigned 1 Send Data 2 Disable Output 3 Freeze Output 4 Direction 5 Reference Z 6 Reset 7 Trim - 8 Trim +	0 ... 8	0
Key Down Func. (similar to Key UP, but additional function of the Down key)	0 ... 8	0
Key Enter Func. (similar to Key UP, but additional function of the Enter key)	0 ... 8	0
Input 1 Config. (Switching characteristics of Input "Cont.1") 0 Static Low 1 Static High	0 ... 1	0
Input 1 Func. (control function of input „Cont.1“) 0 no command assigned 1 Send Data 2 Disable Output 3 Freeze Output 4 Direction 5 Reference Z 6 Reset 7 Trim - 8 Trim + 9 Key Lock	0 ... 9	0
Input 2 Config. (see Input 1 Config. but "Cont.2")	0 ... 1	0
Input 2 Func. (see Input 1 Func. but "Cont.2")	0 ... 9	
Input 3 Config. (see Input 1 Config. but "Cont.3")	0 ... 1	0
Input 3 Func. (see Input 1 Func. but "Cont.3")	0 ... 9	
Input 4 Config. (see Input 1 Config. but "Cont.4")	0 ... 1	0
Input 4 Func. (see Input 1 Func. but "Cont.4")	0 ... 9	0



When any of the control inputs (Cont.1 – Cont.4) is used for referencing of the marker pulse (Parameter „Input Z Config“ $\neq 0$, see [7.2.2](#)), no further assignment of a command will be allowed to this input (i.e. Input X Func. must be 0)

7.2.6. Serial communication settings

Serial transmissions will operate in either the "PC Mode" or in "Printer Mode".

With "PC-Mode", the unit receives a request string and responds with a corresponding data string. For details of the protocol see separate description "SERPRO".

With "Printer Mode" the unit sends data without any request and under Timer control, as described subsequently.

As soon as the unit receives a character, it automatically switches over to PC Mode and operates according to protocol. When for a period of 20 sec. no character has been received, the unit switches automatically back to "Printer Mode" and starts cyclic data transmission again.

Serial -Menu (Configuration of the serial link)	Code	Setting Range	Default
Unit Number (Serial device address) A unit number between 11 and 99 can be assigned to each unit. The address must not contain any zeros (0) since these addresses are reserved for collective addressing of several units.	„90“	11 ... 99	11
Serial Baud Rate (Transmission speed) 0= 9600 Baud 1= 4800 Baud 2= 2400 Baud 3= 1200 Baud 4= 600 Baud 5= 19200 Baud 6= 38400 Baud	„91“	0..6	0
Serial Format (Format of transmit data) 0= 7 Data, Parity even, 1 Stop 1= 7 Data, Parity even, 2 Stop 2= 7 Data, Parity odd, 1 Stop 3= 7 Data, Parity odd, 2 Stop 4= 7 Data, no Parity, 1 Stop 5= 7 Data, no Parity, 2 Stop 6= 8 Data, Parity even, 1 Stop 7= 8 Data, Parity odd, 1 Stop 8= 8 Data, no Parity, 1 Stop 9= 8 Data, no Parity, 2 Stop	„92“	0 ... 9	0

Serial -Menu (Configuration of the serial link)	Code	Setting Range	Default																																			
<p>Serial Protocol</p> <p>Determines the sequence of characters sent, when you use the serial output for cyclic data transmission under timer control (xxxxxxx is the measuring value transmitted).</p> <p>0= Transmission = Unit Nr. – Data, LF, CR 1= Transmission = Data, LF, CR</p> <p>Setting "1" removes the unit address from the string which allows a slightly faster transmission cycle.</p> <table border="1" style="margin-left: 40px;"> <thead> <tr> <th colspan="11">Unit No.</th> </tr> </thead> <tbody> <tr> <td>0:</td> <td>1</td> <td>1</td> <td>+/-</td> <td>X</td> <td>X</td> <td>X</td> <td>X</td> <td>X</td> <td>X</td> <td>LF</td> <td>CR</td> </tr> <tr> <td>1:</td> <td></td> <td></td> <td>+/-</td> <td>X</td> <td>X</td> <td>X</td> <td>X</td> <td>X</td> <td>X</td> <td>LF</td> <td>CR</td> </tr> </tbody> </table>	Unit No.											0:	1	1	+/-	X	X	X	X	X	X	LF	CR	1:			+/-	X	X	X	X	X	X	LF	CR	„F3“	0 ... 1	0
Unit No.																																						
0:	1	1	+/-	X	X	X	X	X	X	LF	CR																											
1:			+/-	X	X	X	X	X	X	LF	CR																											
<p>Serial Timer</p> <p>This register determines the cycle time in seconds for cyclic transmission when the Printer Mode is switched on. Range 0.001 to 9.999 seconds. With setting "0" all cyclic transmission is switched off and the unit will only send data upon request (PC mode)</p>	„F4“	0 ... 9.99	0																																			
<p>Register Code</p> <p>Serial access code of the register which, in Printer Mode, should be transmitted with every cycle.</p>	„F5“	0 ... 19 (:0) ... (:9)	8																																			

7.2.7. Phase Trimming

Trim Settings	Range	Default
<p>Trim Time:</p> <p>Time base (sec.) for adding or subtracting additional impulses to the output frequency (differential frequency = 1/ Trim Time, see also chapter 8)</p>	0,000 ... 1,000	0,100

8. Clarification of Command Functions

Nr.	Command	Description	Assignment	
			Keys	Cont. input
0	no function	The corresponding key or the corresponding control input will not activate any command	yes	yes
1	Send Data	Starts a serial data transmission (see 7.2.6 , Serial Protocol) where the transmit value is determined by "Register Code".	yes	yes
2	Disable Output	Inhibits all output function, i.e. the output frequency is zero while this command is on	yes	yes
3	Freeze Output	Freezes the actual output frequency, i.e. the frequency will be constant and no more follow the input frequency	yes	yes
4	Direction	Changes the direction of the output frequency, i.e. the phase situation A / B will be inverted	yes	yes
5	Reference Z	Sets the internal marker pulse generator and related counters to zero. No marker pulse will appear at the output while this command is active.	yes	yes
6	Reset	Resets the actual conversion error to zero, clears the "Overflow" message and inhibits the frequency output (i.e. output frequency is zero)	yes	yes
7	Trim - *)	Generates a differential frequency f_{diff} that is subtracted from the regular output frequency, i.e. the number of output pulses will be temporary scaled down by $f_{diff} = 1/ \text{Trim Time}$,	yes	yes
8	Trim + *)	Generates a differential frequency f_{diff} that is added to the regular output frequency, i.e. the number of output pulses will be temporary scaled up by $f_{diff} = 1/ \text{Trim Time}$,	yes	yes
9	Hardware keypad interlock	See chapter 6.2	no	yes

*) Trim functions can e.g. be used in position-related applications where it may be necessary to temporary shift the output count with regard to the input count (e.g. to adapt the relative position of a product to the process).

9. Technical Specifications

Power supply:	Input voltage: Protection circuit: Ripple: Consumption:	11 ... 30 VDC reverse polarity protection ≤ 10 % at 24 VDC approx. 65 mA at 24 VDC (with an unloaded encoder supply)
Connections:	Connector type:	screw terminal, 1,5 mm ²
Encoder supply:	Output voltage: Output current:	approx. 5.2 V max. 200 mA
Incremental input:	Signal levels: HTL Characteristic: Internal resistance: Channels: Frequency:	RS422, differential voltage > 1 V TTL: LOW 0 ... 0.5 V / HIGH: 2.5 ... 5,3 V HTL: LOW 0 ... 4 V / HIGH: 10 ... 30 V NPN / PNP Ri ≈ 4.75 kOhm A, /A, B, /B, Z, /Z max. 1 MHz at RS422 and TTL symmetrical max. 300 kHz at HTL and TTL asymmetrical
Control inputs:	Number of inputs: Application: Signal levels: Internal resistance: Signal time:	4 inductive proximity switches or control commands LOW < 2.5 V, HIGH > 10 V (max.30 V), Ri ≈ 3.9 kOhm dynamic signals: min. 50 μs static signals: min. 2 ms
Frequency output:	Signal levels: Channels: Characteristic: Output current: Protection:	approx. 5 ... 30 VDC (depends on applied voltage at COM+ input) A, /A, B, /B, Z, /Z push-pull max. 30 mA / channel short circuit proof
Serial interface	Format: Baud rate: Connections:	RS232 2400 ... 38400 Baud (selectable) screw terminal, 1.5 mm ² or USB port (connector type „Mini“, 5-pin)
Display:	Type: Characteristic:	Background lightened LCD 2 lines, each 16 characters, 3,5 mm
Housing:	Material: Mounting: Dimensions: Protection class: Weight:	Plastic mounting rail (DIN, 35 mm C-Profile) 72 x 91 x 76 mm (w x h x d) IP20 approx. 200 g
Temperature range:	Operation: Storage:	0 °C ... +45 °C / +32 ... +113 °F (not condensing) -25 °C ... +70 °C / -13 ... +158 °F (not condensing)
Failure rate:	MTBF in years:	20.9 a (long-term usage at 60 °C / 140 °F)
Conformity & standards:	EMC 2004/108/EC: LV 2006/95/EC: Guideline 2011/65/EU:	EN 61000-6-2, EN 61000-6-3, EN 61000-6-4 EN 61010-1 RoHS-conform

10. Dimensions

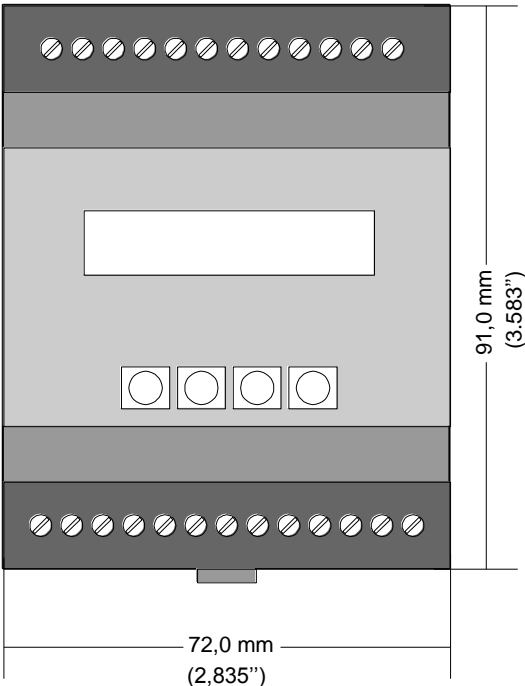

Front view

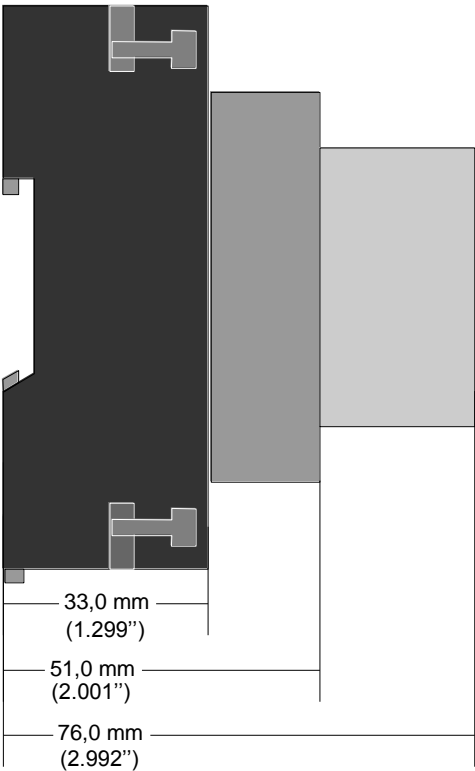

Side view

11. Appendix

11.1. Serial Communication Protocol

All registers are also available for serial readout by PC or PLC. For communication the unit uses the Drivecom Protocol according to ISO 1745. All protocol details can be found in our manual **SERPRO_2a.doc** which is available for download from our homepage

www.motrona.com

To request for a data transmission you must send the following request string to the unit:

EOT	AD1	AD2	C1	C2	ENQ
EOT = control character (Hex 04)					
AD1 = unit address, High Byte					
AD2 = unit address, Low Byte					
C1 = register code, High Byte					
C2 = register code, Low Byte					
ENQ = control character (Hex 05)					

The following example shows the request string for readout of the actual Factor1 setting (code 00) from a unit with unit address 11:

ASCII Code:	EOT	1	1	0	0	ENQ
Hex Code:	04	31	31	30	30	05
Binary Code:	0000 0100	0011 0001	0011 0001	0011 0000	0011 0000	0000 0101

After a correct request, the unit will respond:

STX	C1	C2	x x x x x x x	ETX	BCC
STX = control character (Hex 02)					
C1 = register code, High Byte					
C2 = register code, Low Byte					
xxxxx = readout data					
ETX = control character (Hex 03)					
BCC = block check character					

For all further details see SERPRO_2a.doc.

11.2. Installation of the USB Driver

The USB port provides exactly the same range of functions as the serial interface. For USB connection you need a standard USB cable with a "Mini 5-pin" type connector on one site. The USB driver is available from the CD included to delivery, and can also be downloaded from www.motrona.com.

The driver software is named **CDM 2.04.06 WHQL Certified. zip ***).

As a first step, please store the zip file on your PC and unpack it to a folder on your hard disc. **Please do not connect the USB port to the PC before the driver software has been unpacked!**

After unpacking you can connect the unit by using an appropriate USB cable. The following message will appear:



*) The indication 2.04.06 represents the actual version number of the driver which is subject to change



Conclude the installation by clicking to **"Finish"**

After successful driver installation you have still to assign a serial COM port number to the USB connection, as shown below:

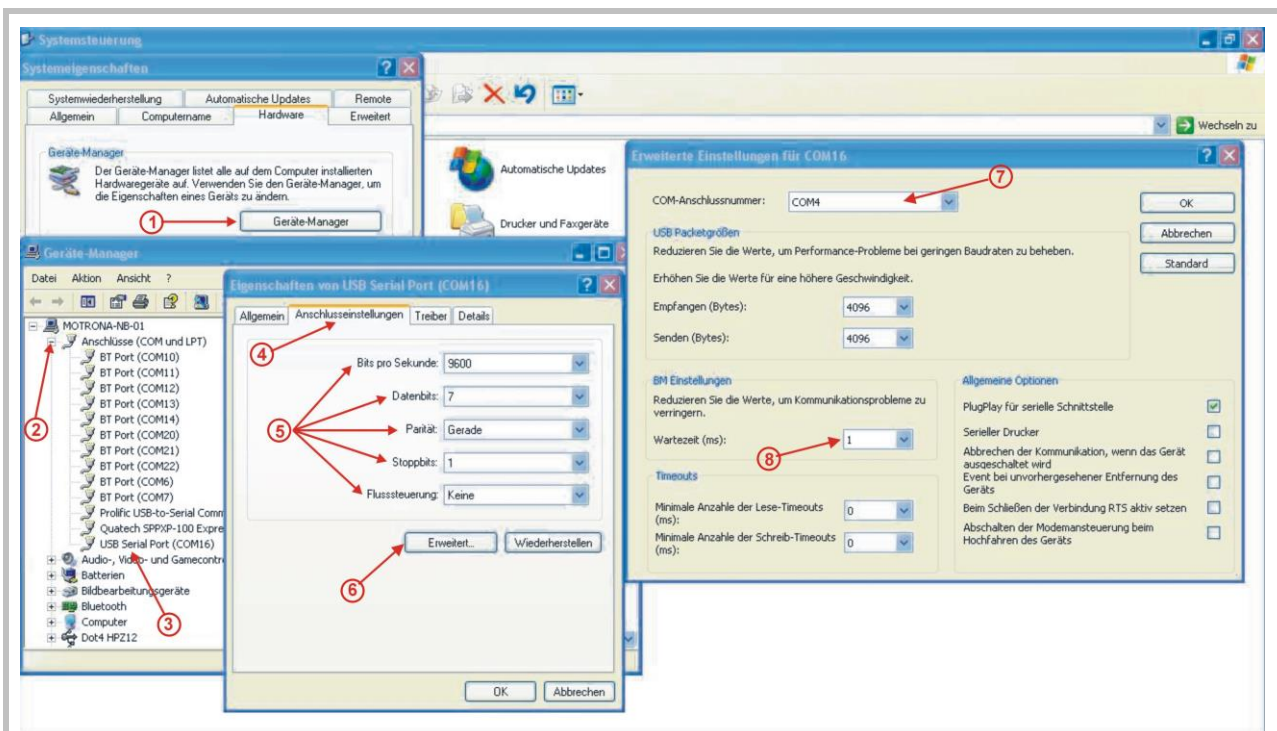

- Select CONTROLS / System / Hardware and open the Device Manager (1).
- In the Device Manager, open „Connections (COM und LPT)” (2)
- By double-clicking to „USB Serial Port (COM x)” (3) the window „Properties of USB Serial Port” will open
- In the menu „Comm. Settings” (4) set the parameters according to motrona standard (5)
- Change over to "Extended Settings" by clicking to „More” (6), then select a port number between COM1 und COM4 according to your convenience (7)
- Set the Wait Time to 1 msec. (8)
- Close all Windows by clicking „OK”

After these steps your PC will be ready to operate with all motrona units providing a USB port

11.3. Serial Code List

11.3.1. Parameters:

No.	Menu	Name	Code	Minimum	Maximum	Default
0	Factor-Setting	Factor 1 (x_fi)	00	5	99999	10000
1	Factor-Setting	Factor 2 (x_fo)	01	5	99999	10000
2	Factor-Setting	Reserved	02	0	10000	10000
3	Factor-Setting	Reserved	03	0	10000	10000
4	Factor-Setting	Reserved	04	0	10000	10000
5	General-Setting	Enc. Properties	A0	0	7	0
6	General-Setting	Direction	A1	0	1	0
7	General-Setting	Z Impulse	A2	1	50000	1000
8	General-Setting	Burst	A3	10	100	20
9	General-Setting	Input Z Config.	A4	0	8	0
10	General-Setting	Reserved	A5	0	10000	10000
11	General-Setting	Reserved	A6	0	10000	10000
12	General-Setting	Reserved	A7	0	10000	10000
13	General-Setting	Reserved	A8	0	10000	10000
14	Display-Setting	Up Date Time (s)	A9	5	100	25
15	Display-Setting	Display Mode	B0	0	3	0
16	Display-Setting	Display Factor	B1	1	99999	100
17	Display-Setting	Display Multi.	B2	1	999	100
18	Display-Setting	Inhibit Overflow	B3	0	2	0
19	Display-Setting	Reserved	B4	0	10000	10000
20	Display-Setting	Reserved	B5	0	10000	10000
21	Key-Pad-Setting	Protect Factor	B6	0	999999	0
22	Key-Pad-Setting	Protect General	B7	0	999999	0
23	Key-Pad-Setting	Protect Display	B8	0	999999	0
24	Key-Pad-Setting	Protect Key-Pad	B9	0	999999	0
25	Key-Pad-Setting	Protect Command	C0	0	999999	0
26	Key-Pad-Setting	Protect Serial	C1	0	999999	0
27	Key-Pad-Setting	Protect Trim	C2	0	999999	0
28	Key-Pad-Setting	Reserved	C3	0	10000	10000
29	Key-Pad-Setting	Reserved	C4	0	10000	10000
30	Key-Pad-Setting	Reserved	C5	0	10000	10000
31	Command-Setting	Key Up Funct.	C6	0	8	0
32	Command-Setting	Key Down Funct.	C7	0	8	0
33	Command-Setting	Key Enter Funct.	C8	0	8	0
34	Command-Setting	Input 1 Config.	C9	0	1	0
35	Command-Setting	Input 1 Funct.	D0	0	9	0
36	Command-Setting	Input 2 Config.	D1	0	1	0
37	Command-Setting	Input 2 Funct.	D2	0	9	0
38	Command-Setting	Input 3 Config.	D3	0	1	0
39	Command-Setting	Input 3 Funct.	D4	0	9	0
40	Command-Setting	Input 4 Config.	D5	0	1	0

11.3.2. Parameters (continued)

No.	Menu	Name	Code	Minimum	Maximum	Default
41	Command-Setting	Input 4 Funct.	D6	0	9	0
42	Command-Setting	Reserved	D7	0	10000	10000
43	Command-Setting	Reserved	D8	0	10000	10000
44	Command-Setting	Reserved	D9	0	10000	10000
45	Serial-Setting	Unit Number	90	0	99	11
46	Serial-Setting	Serial Baud Rate	91	0	6	0
47	Serial-Setting	Serial Format	92	0	9	0
48	Serial-Setting	Serial Protocol	E0	0	1	0
49	Serial-Setting	Serial Time (s)	E1	0	999	0
50	Serial-Setting	Register Code	E2	0	19	0
51	Serial-Setting	Reserved	E3	0	10000	10000
52	Serial-Setting	Reserved	E4	0	10000	10000
53	Serial-Setting	Reserved	E5	0	10000	10000
54	Trim-Setting	Trim Time (s)	E6	0	1000	100
55	Trim-Setting	Reserved	E7	0	10000	1000
56	Trim-Setting	Reserved	E8	0	10000	10000
57	Trim-Setting	Reserved	E9	0	10000	10000
58	Trim-Setting	Reserved	F0	0	10000	10000
59	Trim-Setting	Reserved	F1	0	10000	10000

11.3.3. Control Commands

No.	Name	Code	Command Bit	Serial Access	Bus Access	Remote Access
0	Trim -	60	0080	Yes	No	Yes
1	Key Lock	61	0040	Yes	No	Yes
2	Reserved	62	0020	Yes	No	No
3	Reserved	63	0010	Yes	No	No
4	Reserved	64	0008	Yes	No	No
5	Reserved	65	0004	Yes	No	No
6	Reserved	66	0002	Yes	No	No
7	Store EEPROM	68	0001	Yes	No	Yes
8	Reserved	54	8000	Yes	No	No
9	Freeze Output	55	4000	Yes	No	Yes
10	Reserved	69	2000	Yes	No	No
11	Activate Data	67	1000	Yes	No	Yes
12	Direction	56	0800	Yes	No	Yes
13	Reference Z	57	0400	Yes	No	Yes
13	Reset	58	0400	Yes	No	Yes
14	Trim +	59	0100	Yes	No	Yes