

# FX-Family

## MELSEC PLC

# The world's favorite micro PLCs



**10 Million FX PLCs Worldwide /// Over 30 Years Experience ///**  
**Expanded Micro PLC Control /// Networking Solutions ///**  
**Analog Solutions /// Positioning Solutions ///**

# Global Leader



The MELSEC FX3U/FX3UC series are the third generation on programmable controllers of the Mitsubishi Electric FX family. They offer improved network capability and solutions for positioning tasks.



Mitsubishi Electric Corporation Himeji Works is a factory certified for ISO14001 (standards for environmental management systems) and ISO9001 (standards for quality assurance management systems)



## 10 Million FX

The FX Family of PLCs is the PLC of choice across the world, industries and applications.

Mitsubishi Electric has always worked closely with its customers to design the PLC that they want for their applications. The manufacturing and use of 10 million FX CPUs is a demonstration that this close working relationship has delivered quality, reliability and the product that customers want.

## Over 30 Years

The FX Family of PLCs has been an important part of control engineering for over 30 years. Throughout its history, the product has evolved from the original F Series into today's current FX3G series.

The FX Family has proven to be highly reliable and it consistently improves its compatibility with previous PLC generations.

## Number 1 in the world

Mitsubishi Electric was shown to be the largest volume producer of PLCs in the world following the 2004 Worldwide PLC survey by the respected American automation research company ARC.

# Contents

<b>What makes a world leading PLC?</b>	<b>4-5</b>	
<b>Range overview</b>	<b>6</b>	
<b>FX3U/FX3UC, a new concept in PLCs</b>	<b>7-9</b>	
<b>FX3G, an automation standard</b>	<b>10</b>	
<b>FX1N, the modular micro</b>	<b>11</b>	
<b>FX1S, micro control</b>	<b>12</b>	
<b>Programming and software</b>	<b>13</b>	
<b>Networking</b>	<b>14</b>	
<b>Analog solutions</b>	<b>15</b>	
<b>Positioning solutions</b>	<b>16</b>	
<b>Displays solutions</b>	<b>17</b>	
<b>Applications</b>	<b>18</b>	
<b>Section 2: Technical Informations</b>		

# What makes a world leading PLC range?



## Global use

Wide range power supply means your FX solution will work all over the world.



## International acceptance

Shipping approvals such as Lloyds, German Lloyds, ABS, RINA, Det Norse Vetaritas, for example plus CE and E1 compliance for Low Voltage and EMC directives as well as manufacturing to Automotive industry quality levels, make the FX Family PLCs products to trust.



## Flexible design

The FX Family is designed so that the main PLC CPU acts as a platform to which you can add and customize the special functions you need – making every FX your personal PLC.

Adapter or "ADP" units are used on the left hand side of the main PLC unit.

Memory cassette port is located under the removable front cover.



Optional communication boards are available in USB, RS232C, RS422 and RS485 formats.

The RUN/STOP switch has become a familiar feature with all FX Family PLCs.

The standard RS422 Mini-DIN programming port can also be used for HMI connection.

Main base unit where CPU, I/O and power supply are contained in a single unit.

All FX PLC units can be mounted on a DIN rail or directly mounted with screw fixings.



Simple ribbon connection links each unit together.

Special function blocks can be added to the right hand communications bus of the PLC.

Bright LED lamps indicate I/O and power status.



## Easy Programming

The FX Family incorporates an easy programming concept where several complex tasks can be reduced to a single instruction.



## Fast and reliable

FX PLCs continually push the limits of high speed operation to process your applications more effectively and accurately.

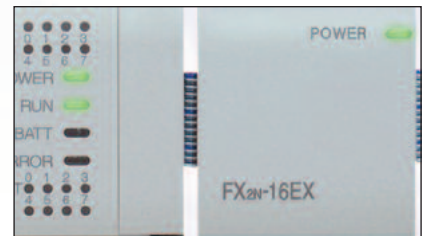

## Compatibility

The FX Family of PLCs continues to raise the level of backward compatibility with many existing FX PLC programs being transferable. And in later models, sharing common peripherals and special function blocks means even greater protection for your investment in both FX and the machine or process being controlled.

# The power to perform

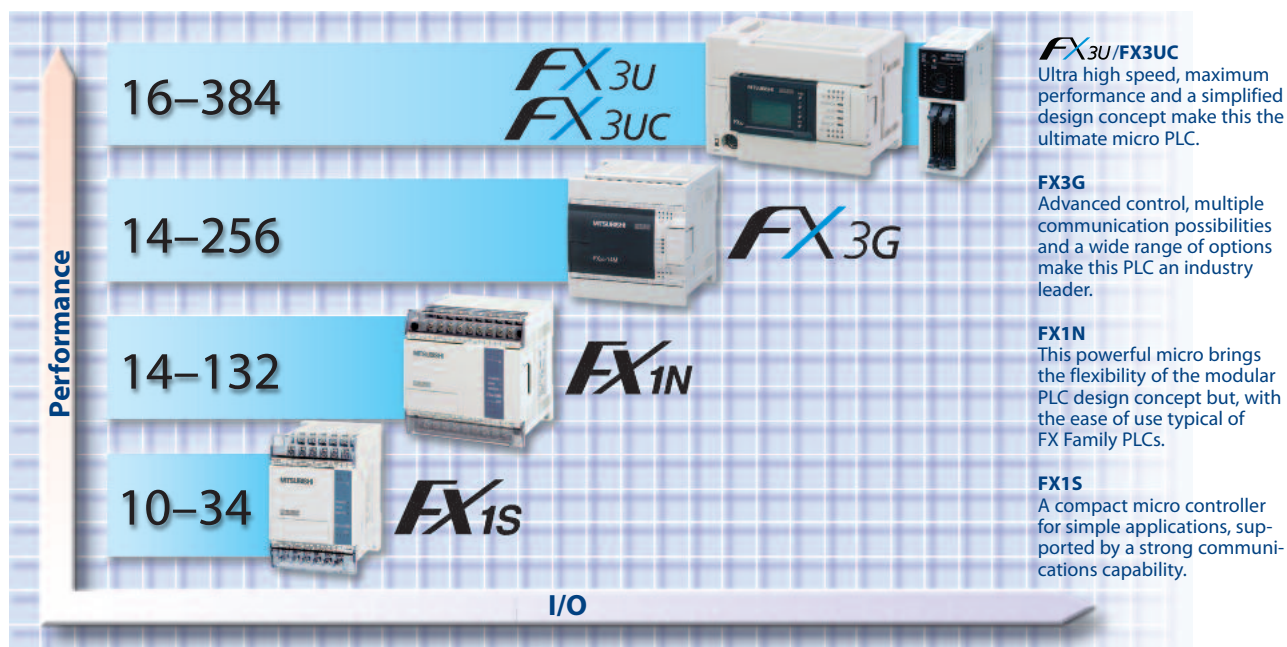

The FX Family of PLCs builds on previous performance and capability, ensuring you have a comprehensive range of control and automation options to choose from.

Model	FX1S	FX1N	FX3G	FX3U	FX3UC
Power supply	100–240 V AC, 24 V DC	100–240 V AC, 12–24 V DC	100–240 V AC	100–240 V AC, 24 V DC	24 V DC
Maximum I/O	30 (34 optional)	128 (132 optional)	256**	384*	384*
Digital I/O	Relay / Transistor	Relay / Transistor	Relay / Transistor	Relay / Transistor	Transistor
Cycle period / logical instruction	0.55 µs	0.55 µs	0.21 µs or 0.42 µs	0.065 µs	0.065 µs
PLC program memory	2 k steps	8 k steps	32 k steps	64 k steps	64 k steps

Summary table of FX PLCs

Note \* : When networked with CC-Link or AS-Interface (Discrete I/O, maximum 256)

Note \*\*: When networked with CC-Link or AS-Interface (Discrete I/O, maximum 128)

## A solution for every application

Micro PLCs have opened up a world of opportunities in Industrial Automation due to their small size and low cost. Now many applications benefit from enhanced performance, easier manufacturing, maintenance and greater reliability.

The FX Family has been a part of this revolution for over 30 years and has developed and redeveloped a range of products to suit most applications. The FX Family consists of four main ranges which are distinct and independent but compatible.

Depending on your application and control needs, you can choose from; the simple FX1S CPU, the modular FX1N range, the powerful FX3U and now the current and dynamic FX3G.

With the FX Family there really is a solution to most applications.



# FX3U a perfect PLC concept

The FX3U CPU brings a combination of greater flexibility and increased performance to the FX Family.

## New high speed bus

The FX3U design has increased the opportunity to configure the PLC directly for your needs.

Following the standard FX Family configuration, the FX3U CPU can be expanded to the right hand side using a wide range of options. These include input and output blocks as well as special function blocks such as analog, pulse train and network communication units.



The FX3U can use new FX3U blocks as well as standard FX2N and FX0N expansion blocks..

The FX3U has an enhanced communications bus that automatically switches into high speed mode for communication with new FX3U expansion modules.

Full compatibility is still available with FX2N and FX0N expansion blocks, and when these are configured the FX3U automatically reduces the bus speed to suit.

This means greater support for existing installed systems as well as delivering high performance and greater response with new installations.

## Adapters add flexibility

A major design enhancement of FX3U is the new adapter expansion bus on the left hand side of the FX3U CPU. Through this bus users can add additional analog and temperature units as well as multiple communications and positioning blocks.



FX3U has a unique new system of directly programmable adapters.

However, the major benefit for the user is that the analog and positioning adapter units no longer require the use of the traditional To/From instruction to configure and operate.

All control is through direct access data registers and setting bits. This means quicker set-up, easier use, and above all much higher processing speeds.

# FX3U/FX3UC. More power. More performance.

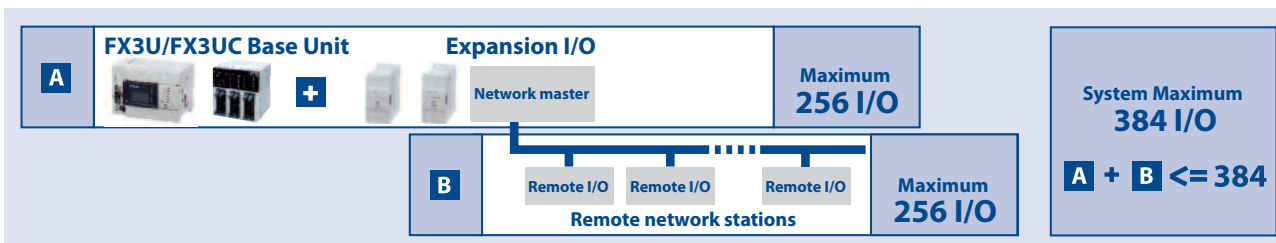

FX3U/FX3UC provides additional I/O and networking capacity.

## Increased I/O capacity

With enhanced networking functions, the FX3U/FX3UC requires an increased input/output (I/O) range. FX3U/FX3UC can support systems with combined local I/O and networked I/O up to a total of 384 I/O points. For users, this means increased system control and added possibilities for advanced networks.

In addition FX3U/FX3UC also fully supports Profibus/DP as well as Ethernet using TCP and UDP protocols.

## 5 times more data storage

With a larger program memory comes the need for more operational devices such as timers, state flags, auxiliary relays and data registers. The FX3U/FX3UC has increased capacity in all of these major areas making program construction easier. Data register capacity has increased by a factor of 5 reflecting the needs of users who have an increased requirement to log operation information against products or batches of products being manufactured.

A typical example of this can be found in the Food and Pharmaceutical industries. Here exact process data such as oven temperatures and cooking times or quantities of ingredients mixed need to be stored against production batches – all this requires increased data handling and data capacity within the PLC.

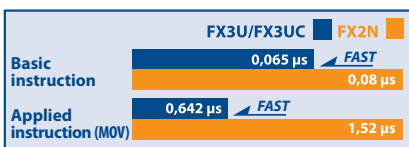

FX3U/FX3UC provides increased performance in all areas.

Note: 4.5 times increase in speed is measured under the following conditions: program capacity=16 k step, with an I/O usage of 144 points. Program scan time is then; FX3U/FX3UC: 4.6 ms and FX2N: 21.0 ms, an increase in processing speed of 4.56 times.

## Up to 4.5 times faster

This means the PC MIX value has been greatly improved with basic instructions now being processed in 0.065 µsec.

For users this means quicker program response and more accurate process performance as inputs, outputs and actions are processed and monitored more times per second.

## 75 new instructions

The FX3U/FX3UC has 75 new instructions in comparison with FX2N. This now makes available 249 instructions for program creation. All of the instructions follow the traditional FX Applied instruction concept designed to make the task of application building and program writing easier and quicker, with less chance for errors.

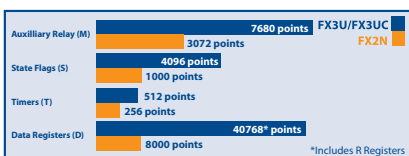

FX3U/FX3UC offers increased resources as well as increased performance.

## 8 times more memory

FX3U/FX3UC comes with a standard internal memory of 64 k steps, which is 8 times more memory than FX2N.

More memory means users can write larger and more complex programs, store more data in file registers, or take greater advantage of using IEC 61131-3 style programming tools.



New instructions include greater control over data processing with a range of new comparison and string manipulation commands.

- LOGE (Nr. 125)**  
Calculates the natural logarithm in floating point
- SORT2 (Nr.149)**  
Sort tabulated data
- TBL (Nr. 152)**  
Batch data positioning mode
- BAND (Nr.257)**  
Defines a band or range of valid numbers
- IVWR (Nr.273)**  
Write parameter to inverter

Some examples of new instructions from the FX3U/FX3UC.

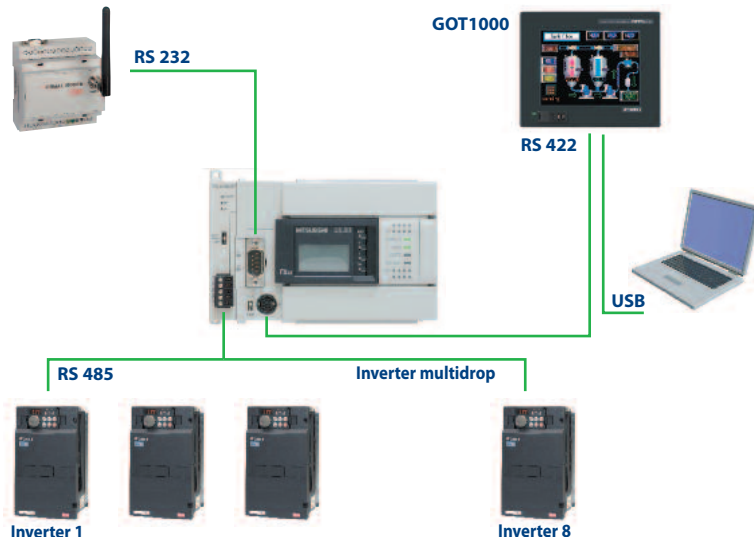

FX3U/FX3UC has a range of flexible communication options.

## Simple high speed positioning

The FX3U/FX3UC has been designed with six high speed counters that can each count up to 100 kHz simultaneously per channel. This, combined with three 100 kHz pulse train outputs, means users can directly configure simple 3-axis positioning systems without the use of additional modules.



Adapter modules increase positioning performance.

However, the new high speed counter ADP and pulse train ADPs can provide the FX3U/FX3UC with maximum positioning performance. Each unit can process signal speeds of up to 200 kHz.

## A great communicator

FX3U/FX3UC has strengthened the communications capability of the FX Family even further.

The new adapters allow up to three RS communication channels to be operated simultaneously allowing multiple HMIs to be connected to a single FX3U/FX3UC CPU or combinations of HMIs, third party devices and programming tools – the choice is yours.

The FX3U/FX3UC also supports a wide range of network options including AS-interface, Profibus-DP, CC-Link, DeviceNet, CANopen as well as Ethernet.

The FX3UC is the ideal choice for applications where there is not much space for the controller hardware. The smallest base unit with 8 digital inputs and 8 transistor outputs takes up just 27 % of the space required for a comparable FX3U unit – and yet the FX3UC incorporates all the features of the FX3U.

The connections for the FX3UC inputs and outputs on the front side can be wired with ribbon cable connectors. For this purpose system cabling sets and remote I/O terminal blocks for easy and fast connections are available.

## FX3U/FX3UC at a glance

- I/O range**  
16–384 (Discrete I/O, maximum 256)
- Program memory**  
64 k steps (standard)
- Basic instruction processing**  
0.065 µsec/logical instruction
- Analog signal processing**  
Up to 80 analog inputs,  
Up to 48 analog outputs
- Analog resolution**  
8, 12 and 16 bits
- Analog options**  
19 analog input, output and temperature blocks available for selection
- Positioning**  
Internal:  
6 high speed counters (100 kHz)  
2 high speed counters (10 kHz)  
3 pulse train outputs (100 kHz), transistor unit only  
External (FX3U only):  
High speed counter block (50 kHz)  
High speed counter ADP module (200 kHz)  
Pulse train ADP (200 kHz)  
Pulse train output block (1 MHz)

# FX3G an industry standard



FX3G PLCs are used in many applications for processing and packaging as well chilled storage and transportation of food items.



Since its launch, the FX3G has been a standard of micro PLC control.

## Customized control

The FX3G is an introductory compact PLC and is the newest addition to the FX3 series, designed for simple yet performance-critical applications that require discrete control of up to 128 local I/O or up to 256 I/O with CC-Link remote I/Os. Incorporating innovative FX3 series technology the customer is presented with a suite of benefits. These include a large program memory to implement sophisticated algorithms plus high speed execution to enhance system productivity.



FX3G has the versatility to handle applications from a wide range of industries.

## Highly flexible

A dual bus architecture provides flexible expansion possibilities and with the ability to handle analog, high speed, positioning, and inverter control, the FX3G is able to successfully adapt to a range of applications in industry areas such agriculture, water processing, material handling, food processing and more.

## The great communicator

With a wide range of network and serial protocols available, such as Ethernet, CC-Link and Modbus, the FX3G enables seamless integration and data communications between both Mitsubishi Electric and third-party devices. Furthermore, a built-in USB port permits convenient connection to any PC or laptop.

## FX3G at a glance

### I/O range

14–256 (Discrete I/O, maximum 128)

### Program memory

32 k steps (internal)

### Basic instruction processing

0.21  $\mu$ s or 0.42  $\mu$ s/logical instruction

### Analog signal processing

Up to 74 analog inputs

Up to 41 analog outputs

### Analog resolution

8, 12 and 16 bit

### Analog options

19 analog input, output and temperature blocks available for selection

### Positioning

Internal:

Up to 4 high speed counters (max. 10 kHz)

up to 2 high speed counters (max. 60 kHz)

up to 3 (2) pulse train outputs (100 kHz)

# FX1N the modular micro



FX1N has six shipping approvals. It has been used in applications from controlling temperature in containers to managing diesel engines.



The FX1N offers comprehensive expansion options.

The FX1N provides a simple introduction to modular micro control offering comprehensive functionality and expansion options.

## Compatibility cuts costs

The FX1N provides many user benefits including excellent compatibility with other FX Family PLCs. The FX1N is upwardly compatible to the FX2N/FX3G using many of the FX2Ns I/O and special function blocks. It also shares the same programming structure as the FX1S. This means that users benefit from learning and using one PLC programming syntax; resulting in faster program development and reduced programming errors.

In addition, users benefit from a reduced stock and spare parts requirement as the FX1N uses the same expansion boards as the FX1S and the same special function and expansion I/O blocks as the FX2N.

## Powerful performance

The FX1N saves space, cost and engineering time with the use of powerful, built in, positioning tools such two 100 kHz pulse train outputs and up to two 60 kHz high speed counters. These can be used to create simple 2-axis positioning systems, linked to servo amplifiers or stepper motor drivers without the need for additional PLC hardware saving space, cost and engineering time.

## FX1N at a glance

### I/O range

14–132

### Program memory

8 k steps (standard)

### Basic instruction processing

0.55 µsec/logical instruction

### Analog signal processing

66 analog inputs

33 analog outputs

### Analog resolution

8, 12 and 16 bits

### Analog options

12 analog input, output and temperature blocks available for selection

### Positioning

Internal:

2 high speed counters 60 kHz,

4 high speed counters 10 kHz

2 pulse train outputs (100 kHz), transistor unit only

# FX1S micro control



FX1S has been used in a wide range of embedded control applications.



FX1S offers communication and real time control from a single unit.

## Fit and forget

Typically FX1S applications are small, embedded control functions that are hidden away or inaccessible under normal maintenance activities. This is why the FX1S has been designed to be a robust low maintenance PLC. Features such as the maintenance free, 2000 step EEPROM memory and real time clock management all help to make the FX1S a self managing system, reducing the impact on the maintenance engineer.



Example of connectivity to 3rd party products

## Remote control

The FX1S has an additional range of BD expansion boards providing RS232, RS485 and RS422 communications options. These can be used to connect and control various third party products such as bar code readers or panel printers.

## Simple programming

The FX Family has a simple programming structure combining Basic and Applied instructions. The Basic instructions are common to all FX Family PLCs. Applied instructions provide the specialist control options such as data comparisons, PID and communications control, all of which are available on FX1S. As each FX PLC range increases in capability (FX1S, FX1N, FX3G, FX3U/FX3UC) so do the number of available Applied instructions.

## FX1S at a glance

### I/O range

10-34

### Program memory

2 k steps (standard)

### Basic instruction processing

0.55 µsec/logical instruction

### Analog signal processing

Up to 2 points

### Analog resolution

12 bits

### Analog options

2 analog input BD board

1 analog output BD board

### Positioning

Internal:

2 high speed counters 60 kHz,

4 high speed counters 10 kHz

2 pulse train outputs (100 kHz),  
transistor unit only

# Progressive software concepts

The Mitsubishi FX PLC Family has a worldwide reputation for reliability, performance and ease of use. These key values have also been used to form Mitsubishi's integrated software concept, MELSOFT.

## Productivity tools

Programming software for PLCs is constantly evolving. Users are placing more focus on reusable program code and function block concepts. This helps to reduce errors, reduce programming time and to help manage the whole programming process – increasing overall productivity.



Often the biggest cost on a project is engineering time.



MELSOFT is a wide range of software solutions designed to optimize your plant productivity.

## Simple and intuitive

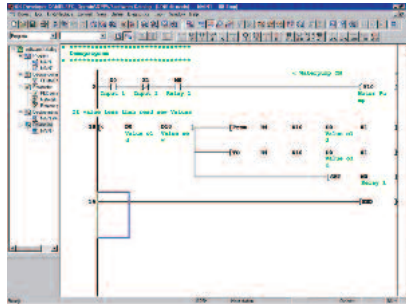

GX Developer offers ease of use for programmers of all skill levels.

The key to any good software is that it is simple to use. Mitsubishi's GX Developer PLC programming packages have achieved this by using intuitive design.

They also have comprehensive help functions and an advanced communications layer, ensuring safe reliable communication to the target PLC.

## Choose what you need

GX Developer offers users the chance to program all Mitsubishi MELSEC PLCs from a single package. However, for users who only need support for FX based systems there is GX Developer FX.

Mitsubishi also provide GX IEC Developer packages, providing IEC61131-3 compliant programming in; Instruction List, Ladder, Function Block, Structured Text and SFC formats. Using standard programming languages, like IEC61131-3, on large programming projects can help users save costs by creating reusable PLC code and Function Blocks.

## One step further with iQ Works

Mitsubishi Electric's iQ Works software is a suite of four MELSOFT software packages that enable intuitive programming and setup of an iQ Platform system, including system/network configuration, Q and FX Series programming, Q Motion Controller and Servo setup, GOT1000 HMI screen design. This next generation software provides a fully customizable user friendly environment with the developers in mind.

## First time user?

For users who do not have the time to take local training, there is the option of using Mitsubishi's home study software, FX-TRN-BEG, where PLC programs can be created, simulated and debugged in the safety of a PC simulation.

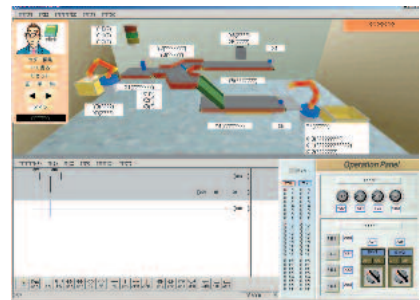

Learning to program can be achieved quickly using interactive software.

# Networking and communication solutions

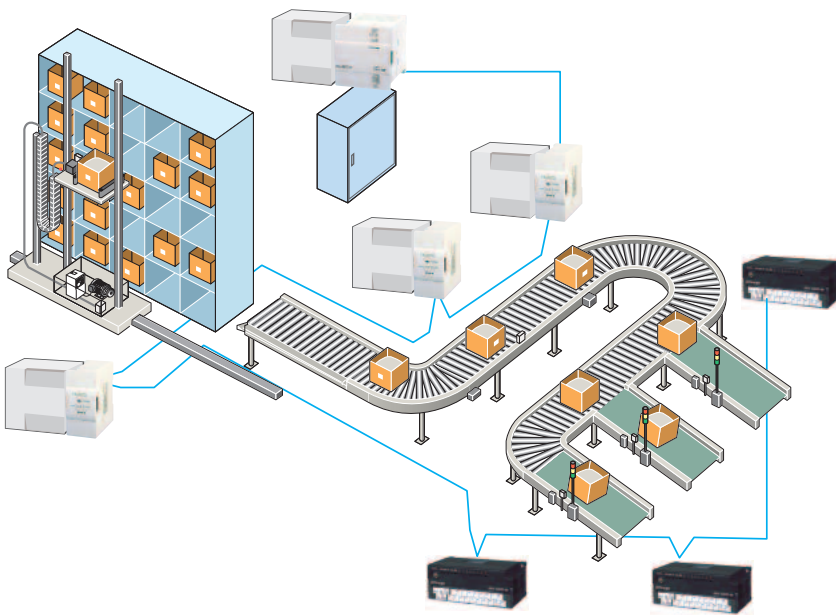

FX Family PLCs have a wide range of communications options.

Applications are often required to integrate between each other across a factory, to report production or tracking data back for office based processing and in some cases be remotely monitored and maintained when the application is in an inaccessible location. The FX Family of PLCs has evolved to match this demand at all levels.

## Networks make sense

Networked solutions to complex applications often make the overall solution easier to achieve and more cost effective. For example a conveyor system integrated with a warehouse pick and place system may extend over many hundreds of meters, and by using a fieldbus, such as CC-Link, wiring, troubleshooting and maintenance can be dramatically reduced.

## Remote maintenance

With communications technology it is now possible to put PLC control in the most remote locations. Using a PLC with a RS232 interface to a telemetry solution, such as a GSM modem, allows the user the ability to remotely monitor and maintain the system. It can also allow the remote system to send alarm messages, warnings or general status information back to the user's central data processing centre.



Example of remote pumping station.

## Easy communications

Today's FX Family of PLCs share a basic communication concept where additional RS232, RS422 or RS485 communications boards can be added to the main base unit without increasing the required cabinet space. These can then be used for communication to various third party devices like bar code readers, printers and modems.

FX Family PLCs, such as FX1N, FX3G, FX3U and FX3UC, have a wider range of communications modules. These include options for connection to open and bespoke networks such as Ethernet, Profibus-DP, CC-Link, DeviceNet, CANopen, AS-interface or Modbus for example.

# Analog solutions

Analog control is one of the most important areas for any automation system. Critically for users the concern is to match the performance demanded by the application to the available solutions in a cost effective way.

## Where is analog used?

Analog control is widely used. In simple terms it allows a variable signal to be used to control items such as a motor's speed or to sense inputs such as fluid levels.

### ■ Digital to analog (D-A) control

Here a digital PLC value is output as an analog signal. It can be used, for example, to send a speed command to an inverter which in turn causes the motor to increase or decrease speed.

### ■ Analog to digital (A-D) control

In this type of control a variable signal is sent to a PLC where it is converted in to a direct digital value. An example of this could be the measurement of the level of a liquid in a storage tank so that the exact amount of stored liquid can be controlled by the PLC.

### ■ Temperature control

Temperature control is the third type of analog control. An example of use could be where the temperature of a furnace is measured and compared by the PLC against a set range. Additional heating or cooling can then be applied to maintain a constant temperature.

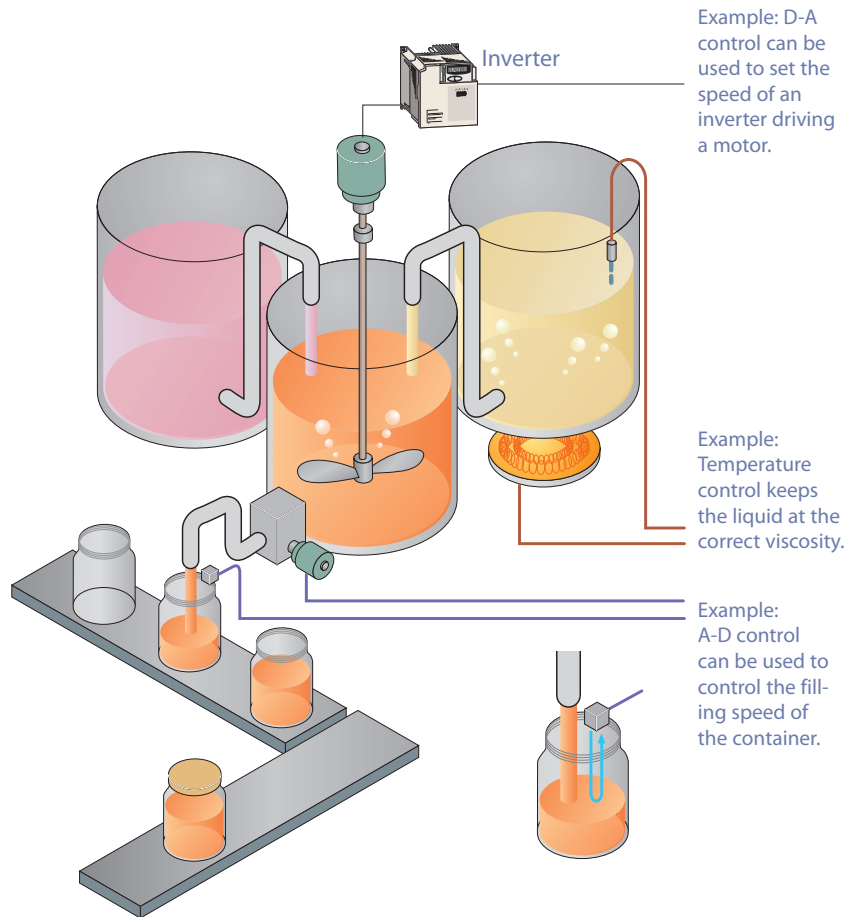

Example: D-A control can be used to set the speed of an inverter driving a motor.

Example: Temperature control keeps the liquid at the correct viscosity.

Example: A-D control can be used to control the filling speed of the container.

Analog solutions are an important part of control engineering and can be used to simplify and accurately control actions happening in the production environment.

## 22 solutions to choose from

The FX Family offers a wide range of analog solutions from 1 and 2 channel BD boards for FX1S up to 8 channel input blocks like the FX2N-8AD where temperature, voltage and current input can be mixed on the same block. FX analog blocks also come in a range of resolutions from 8 bit up to 16 bit signal processing. Overall there are 22 different analog options available to users of the FX PLC Family.

With this range of choice and flexibility it is sure that there will be a solution here for most applications.



Example of temperature control.

# Positioning solutions

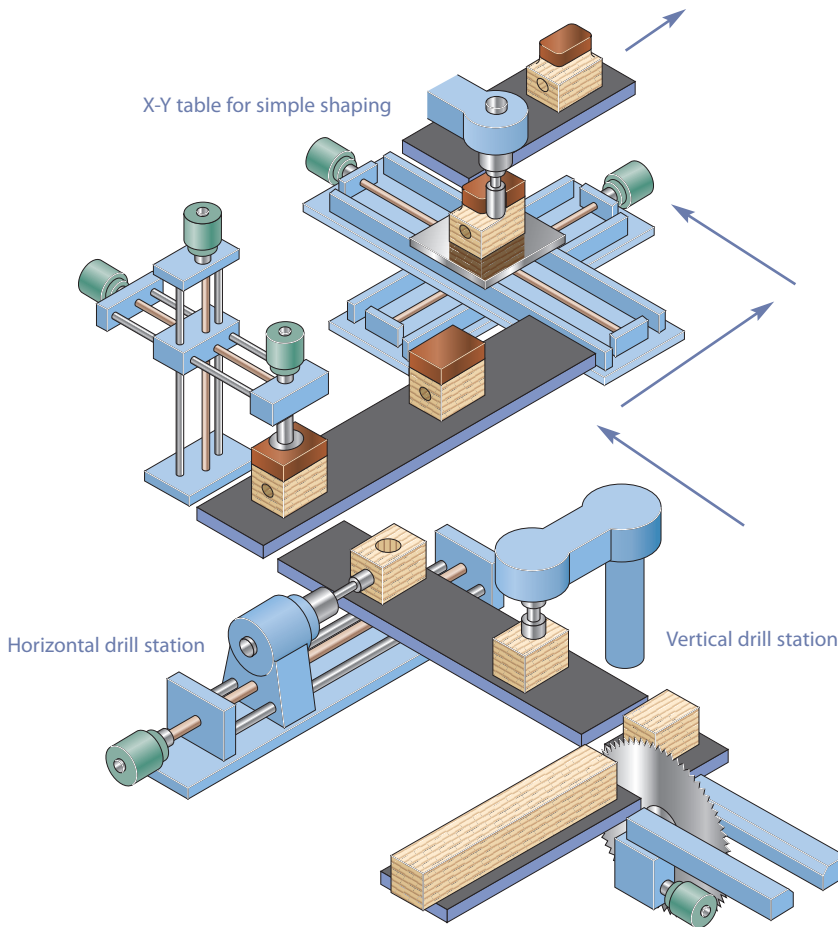

Simple positioning solutions can be effectively managed within a standard FX PLC.

Using simple positioning solutions can help increase the accuracy of the work process, reduce waste and rework as well as provide a higher quality of production.

## Typical applications

Simple positioning applications typically involve independently controlled operational axis and can sometimes have many requirements. In the example of an X-Y table, a relative position is achieved by driving each axis until its target position is achieved, regardless of what happens with the other axis. There are two main elements to achieve this type of positioning control.

### ■ Pulse train outputs

A stream of output pulses can be used as a drive signal to a line driver, stepper motor or servo amplifier, which then causes the connected motor to perform the positioning activity.

The larger the range of output pulse frequencies available means greater speed and/or accuracy is achievable. For example, if a stepper motor with a larger number of steps is used, the travel distance per step can be reduced, resulting in an increased system accuracy.

### ■ High speed counter input

When a motor is being driven, its relative position can be controlled by counting the number of output pulses.

However, for a more accurate process, reading the actual position from an encoder feedback directly into a high speed counter is preferred. This helps to overcome issues of backlash and slippage as the actual position is measured and not assumed.

## Positioning built in as standard

FX PLCs come with high speed counters (in some cases up to 100 kHz) and pulse train outputs (also in some cases up to 100 kHz) as standard. The high speed counters can be configured in single pulse train inputs, The high speed counters can be configured in a single or two phase input.

Pulse train outputs can be configured to provide continuous pulse streams at different frequencies or a set quantity of pulses at a single frequency.

There are also optional modules and adapters that can provide additional high speed counters with performance up to 200 kHz. The same is true for pulse train outputs with 200 kHz and 1 Mpps (1 MHz) output options available.



Example of conveyor belt control.



# Display solutions

An increasingly important area of any automation solution is the reporting and display of operational information. This data enables operators, maintenance teams and business managers to make informed decisions in the best interests of the business.

## The right tool for the right job

For maximum efficiency, each user requires access to information at their work place in a form that highlights the important data for them first. This means a range of different tools are required. As an example, here are three possible scenarios.

### ■ The machine operator

Machines often have a lot of manufacturing debris around or are subject to hygienic cleaning as in the food industry. Any display located in this environment would need to have a high Ingress Protection (IP) rating, indicating a high degree of water-proofness.



In the food industry hygiene is very important.

It may also be a benefit to the operator to have a large and clear display to reduce the chances for error from misreading, due to poor light or small fonts being used. It is also recognized that the use of graphics also reduces the chances for reading errors with complex data.

### ■ The maintenance team

The critical information for a maintenance engineer is the error and diagnostic data within the PLC as this is used to diagnose any process problems. However, additional



The FX3U-7DM can be directly mounted within the PLC (FX3U) or mounted on the front cabinet.

information regarding the operational "hours run" or cycles processed, which could be called soft information as it is calculated on operational parameters, could allow the maintenance engineer to predict possible failure and arrange preventative maintenance.

Access to this data could be through the machine operator's terminal, across a network or through a dedicated display mounted inside or on the control cabinet itself.

### ■ The business manager

In a production controllers office it would be better to display information through a network to their existing desktop PC. In this application a piece of software such as an OPC server/client, a Java applet, an Active X control or a SCADA system would allow lots of data from lots of sources to be displayed in a clear and concise way giving the production controller the overview of the business operation that they need.

## Data the way you want it

Mitsubishi offers a wide range of visualization solutions from simple data displays such as the FX3U-7DM, advanced Graphic Operator Terminals like the GOT1000 Series and E1000 Series, and a wide choice of software solutions from the MELSOFT software suite.

This powerful combination of hardware and software means there is a cost effective solution for most applications.



The GOT1000 is a typical HMI.

# Where have FX PLCs been used?



Sanitation management on Eurostar rollingstock.

Customer applications with FX PLCs have been wide spread from critical applications in pharmaceutical industries to sublime applications in the leisure industry. However, the FX PLC Family still remains the PLC of choice for many machine builders as it is flexible, compact and easy to use, which is why it is so often used.

Here are just a few examples of applications that customers have completed in the past

- Agriculture
  - Plant watering systems
  - Plant handling systems
  - Saw mill (wood)
- Building management
  - Smoke detection monitoring
  - Ventilation and temperature control
  - Lift (elevator) control
  - Automated revolving doors
  - Telephone management
  - Energy management
  - Swimming pool management
- Construction
  - Steel bridge manufacturing
  - Tunnel boring systems
- Food and drink
  - Bread manufacture (mixing/baking)
  - Food processing (washing/sorting/slicing/packaging)

- Leisure
  - Multiplex cinema projection
  - Animated mechatronics (museums/theme parks)
- Medical
  - Respiration machine testing
  - Sterilization
- Pharmaceutical/chemical
  - Dosing control
  - Polution measurement systems
  - Cryogenic freezing
  - Gas chromatography
  - Packaging
- Plastics
  - Plastic welding systems
  - Energy management systems for injection molding machines
  - Loading/unloading machines
  - Blow molding test machines
  - Injection molding machines
- Printing
- Textiles
- Transportation
  - Sanitation on passenger ships
  - Sanitation on rail rolling stock
  - Fire tender, pump management
  - Waste disposal truck management
- Utilities
  - Waste water treatment
  - Fresh water pumping



Swimming pools are managed using FX PLCs.

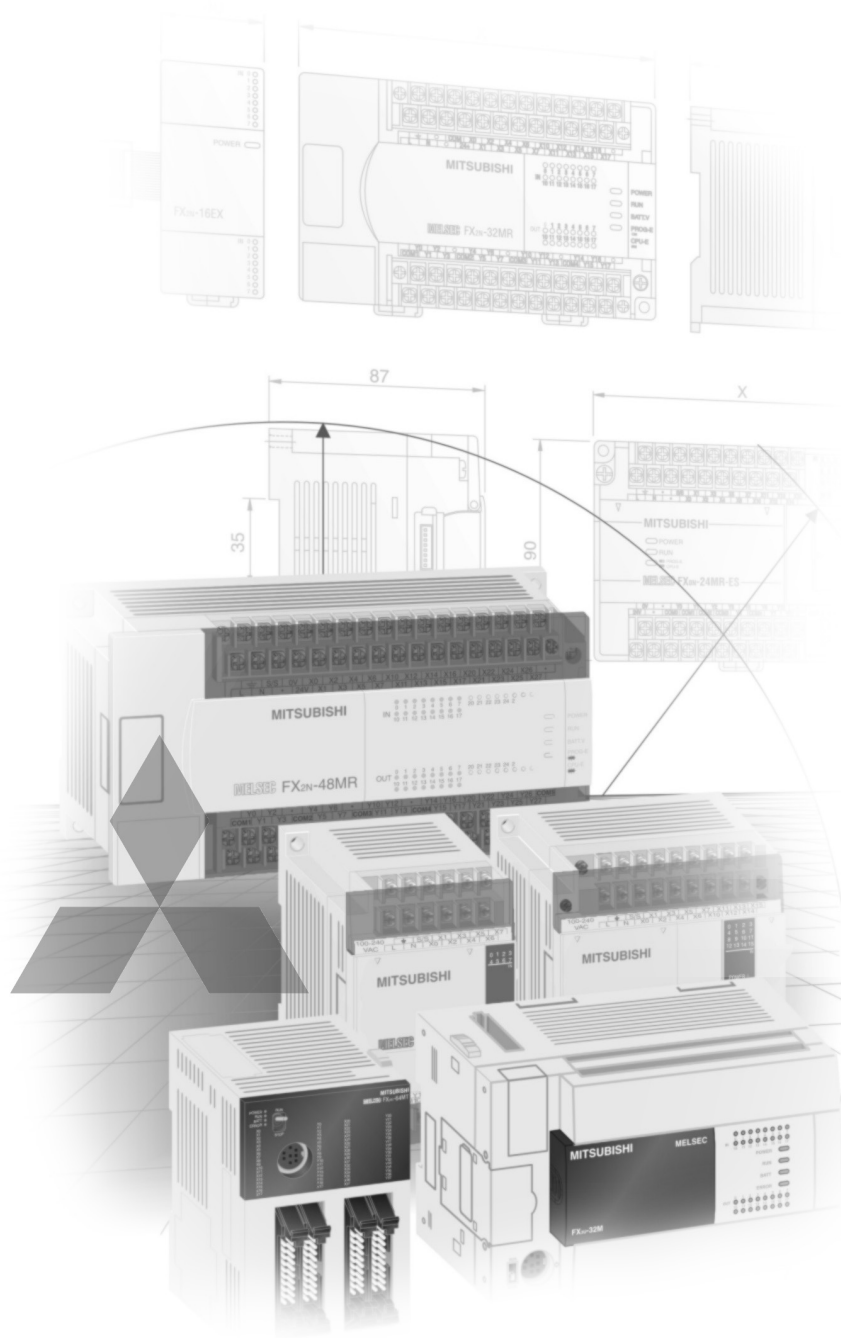

---

## Technical Information Section

## Further Publications within the PLC Range

### *Brochures*

#### **System Q Family**

Product catalogues for programmable logic controllers and accessories for the further MELSEC PLC series

#### **HMI Family**

Product catalogue for operator terminals, supervision software and accessories

#### **Inverter Family**

Product catalogue for frequency inverters and accessories

#### **Servo and Motion Systems**

Product catalogue for servo amplifiers and servo motors as well as motion controller and accessories

#### **Robots Family**

Product catalogue for industrial robots and accessories

#### **Low Voltage Switchgears**

Product catalogue for low voltage switchgears, magnetic contactors and circuit breakers

#### **Automation Book**

Overview on all Mitsubishi automation products, like frequency inverters, servo/motion, robots etc.

---

### **More information?**

This product catalogue is designed to give an overview of the extensive range of FX Family of MELSEC PLCs. If you cannot find the information you require in this catalogue, there are a number of ways you can get further details on configuration and technical issues, pricing and availability.

For technical issues visit the [www.mitsubishi-automation.com](http://www.mitsubishi-automation.com) website.

Our website provides a simple and fast way of accessing further technical data and up to the minute details on our products and services. Manuals and catalogues are available in several different languages and can be downloaded for free.

For technical, configuration, pricing and availability issues contact our distributors and partners.

Mitsubishi partners and distributors are only too happy to help answer your technical questions or help with configuration building. For a list of Mitsubishi partners please see the back of this catalogue or alternatively take a look at the "contact us" section of our website.

### **About this product catalogue**

This catalogue is a guide to the range of products available. For detailed configuration rules, system building, installation and configuration the associated product manuals must be read. You must satisfy yourself that any system you design with the products in this catalogue is fit for purpose, meets your requires and conforms to the product configuration rules as defined in the product manuals.

Specifications are subject to change without notice. All trademarks acknowledged.

© Mitsubishi Electric Europe B.V., Factory Automation - European Business Group

**System Description**

- ◆ ALPHA and MELSEC PLC system ..... 4
- ◆ Extension modules and special function modules ..... 6

**1 ALPHA Controllers**

- ◆ Base units ..... 8
- ◆ Extension units and accessories ..... 11

**2 MELSEC FX Base Units**

- ◆ FX1S series ..... 13
- ◆ FX1N series ..... 16
- ◆ FX3G series ..... 19
- ◆ FX3U series ..... 22
- ◆ FX3UC series ..... 26

**3 MELSEC FX Extension Units**

- ◆ Powered compact extension units ..... 29
- ◆ Unpowered modular extension blocks ..... 31

**4 MELSEC FX Special Function Modules**

- ◆ Analog modules ..... 33
- ◆ Temperature control modules/Data logger modules ..... 36
- ◆ High-speed counter modules ..... 37
- ◆ Positioning modules ..... 38
- ◆ Network modules ..... 39
- ◆ Communications modules, Interface modules ..... 45
- ◆ Adapter boards and communications adapter ..... 46
- ◆ Interface adapters ..... 49

**5 Accessories**

- ◆ Expansion Adapter ..... 50
- ◆ Memory media ..... 50
- ◆ External Terminal Blocks ..... 51
- ◆ Power supply units ..... 53
- ◆ Backup batteries, Cables ..... 53
- ◆ Display modules ..... 55

**6 Dimensions**

- ◆ Base and extension units ..... 56
- ◆ Special function modules ..... 60
- ◆ Accessories ..... 62

**7 Software & Programming**

- ◆ Trainings and programming software ..... 63
- ◆ Programming unit ..... 66

**Others**

- ◆ Approvals ..... 67
- ◆ Index ..... 69

## ALPHA and MELSEC PLC Systems

### The ALPHA Series

The ALPHA closes the gap between single components and a PLC system. It combines all advantages of a PLC system in a very compact housing and therefore provides a space and cost saving alternative to relays and contactors.

The ALPHA series is suited to applications in industrial machines and in automated building services.

Key enhancements in the ALPHA2 include a program capacity of 200 function blocks, an extra-large display, expansion options and a second communications port. The instruction set, includes math operations, PWM and SMS text messaging functions. All this opens up possibilities for analog and temperature control as well as remote operation.

### The MELSEC FX Family

The MELSEC FX family includes a very comprehensive range of base and expansion modules, enabling you to configure a customised system tailored to your precise requirements.

Depending on your application and control needs you can choose from the small, attractively-priced, "stand-alone" FX1S series, the expandable FX1N series or the more powerful FX3G and FX3U series.

With the exception of the FX1S all FX series can be expanded to adapt them to the changing needs of your installations and applications.

Network integration is also supported, making it possible for your FX controllers to communicate with other PLCs, controllers and HMIs. The PLC systems can be configured as local stations in MITSUBISHI networks. In addition these flexible units can also be used as master or slave units on fieldbus's like Profibus/DP and CC-Link.

The MELSEC FX Family controllers also support CANopen, DeviceNet, AS-Interface and Ethernet. Special versions with E-Mark label (ECE requestion) are available upon request for vehicle application.

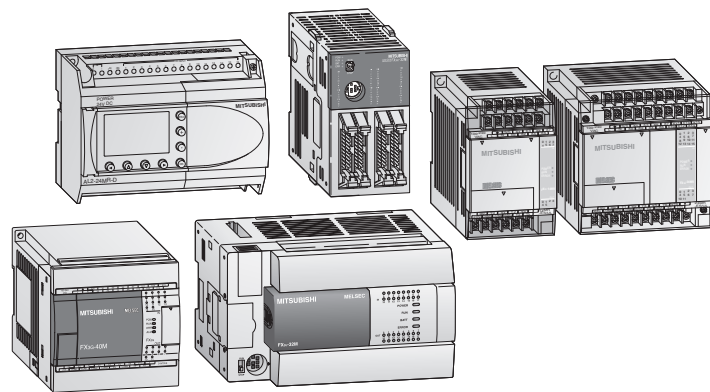

### Expandability and Power

The MELSEC FX family is highly flexible, enabling fast and efficient configuration and programming for the application at hand.

It is the ideal choice, no matter whether you need to install a simple control application requiring 30 I/Os (FX1S) or a demanding, complex system with up to 384 I/O points (FX3U).

The use of memory cassettes can expand the available programming space on some FX Family PLCs while generally providing a long term program storage option for all FX PLC users. In addition, memory cassettes can also allow programs to be switched at very short notice simply by replacing the cassette.

There are five series in the MELSEC FX family, each of which is designed for a different application profile:

#### ● The FX1S Series

The MELSEC FX1S series is the inexpensive entry to the MELSEC FX family. With its small dimensions it is also an excellent alternative to relay/contactors control configurations.

#### ● The FX1N Series

The CPUs of the FX1N series offer more power than the FX1S series, plus modular

expansion capabilities. You can choose from I/O expansion modules and special function modules for a wide variety of applications.

#### ● The FX3G Series

The FX3G is an introductory compact PLC and is the newest addition to the FX3 series, designed for simple yet performance-critical applications. Incorporating innovative FX3 series technology the customer is presented with a suite of benefits.

#### ● The FX3U Series

The FX3U series gives you the freedom of modular expandability, with a wide selection of expansion modules and special function modules.

The FX3U is the fastest PLC systems available, with a cycle time of just 0.065  $\mu$ s per logical instruction. This gives users a powerful CPU delivering modular PLC performance in a compact PLC design.

#### ● The FX3UC Series

The performance of the FX3UC is the same as that of the FX3U series, but it has more compact dimensions. It is the ideal choice for applications where little space is available for the controller.

Thus the FX3U and FX3UC series give you the most powerful CPU for your application and combines all benefits of a compact PLC system with the performance of a modular PLC system.

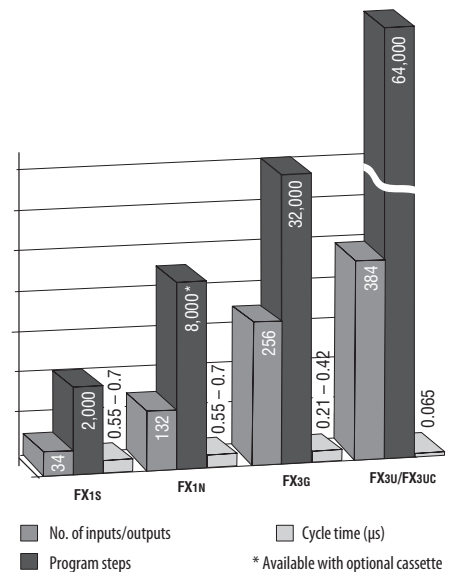

## Features

The modular design of the FX family makes it extremely flexible, enabling it to be used for a very broad range of applications.

You can configure tailor-made systems by combining modules from a variety of different categories (see figure).

All modules are electrically isolated from their environment with optocouplers for maximum reliability.

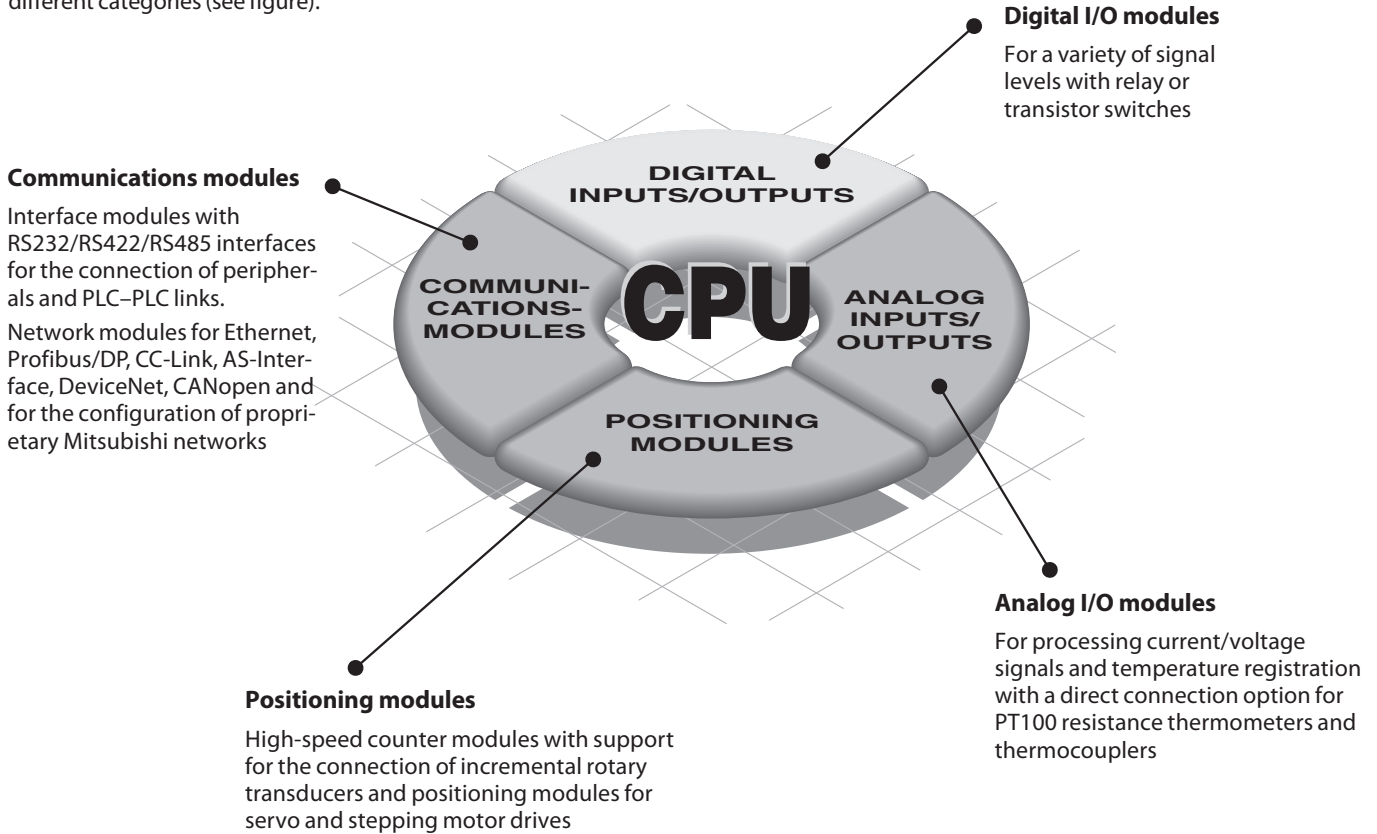

### Digital and special function modules – configuration

The options for using digital and special function modules are dictated by the CPU used in the system.

When calculating the number of special function modules you can use in a system you must take both the number of digital modules and the maximum number of special function modules that can be used into account.

The table on the right provides a simplified guide to the number of modules you can use in each system type. More detailed information and the basic principles of system configuration can be found in the corresponding manuals.

CPU type	System restrictions
FX1S	Stand-alone PLC with 10 / 14 / 20 or 30 I/Os; no special function modules but 1 I/O adapter board can be installed
FX1N	PLC with max. 132 I/Os A maximum of 2 special function modules or digital expansion modules with up to 32 inputs and outputs (4x8 I/Os or 2x16 I/Os) or one special function module and one digital extension module with up to 16 inputs and outputs (2x8 I/Os or 1x16 I/Os) can be connected.
FX3G	PLC with max. 256 I/Os A maximum of 8 special function modules and digital extension modules with up to 128 I/Os can be connected to the right side of the main unit. In addition, a maximum of 4 special adapters from the FX3U series can be connected to the left side.
FX3U	PLC with max. 384 I/Os To the left side of the main unit, a maximum of 10 special adapters from the FX3U series can be connected. To the right side of the main unit, up to 8 special function modules and digital extension modules with up to 256 I/Os can be connected.
FX3UC	PLC with max. 384 I/Os To the left side of the main unit, a maximum of 6 special adapters from the FX3U series can be connected. To the right side of the main unit, up to 4 special function modules and digital extension modules with up to 256 I/Os can be connected.

## The Components for an FX PLC System

A basic FX PLC system can consist of a stand alone base unit, with the functionality and I/O range increased by adding extension I/O and special function modules. The following section provides an overview of options available.

### Base Units

The entire FX PLC range can be AC or DC powered with a mix of input and output styles. The PLCs can be programmed with the user friendly GX or GX IEC Developer programming software, allowing programs to be transferred between different FX PLCs. All PLC base units include an integrated real time clock.

Base units are available with different I/O configurations from 10 to 128 points but can be expanded to 384 points depending upon the FX range selected.

### Extension Boards

Extension adapter boards can be installed directly into the base unit and therefore do not require any additional installation space. For a small number of I/O (2 to 4) an extension adapter boards can be installed directly into the (left-hand side) FX1S, FX1N, FX3G or FX3U controller. Interface adapter boards can also provide the FX PLC with additional RS232, RS422, RS485 or USB interfaces. To connect special function modules (e.g. Ethernet module) a communication adapter has to be installed (except FX3UC).

### Extension I/O Modules

Unpowered and powered extension I/O modules can be added to the FX1N/FX3U and FX3UC PLCs.

For expansion modules powered by the base unit, the power consumption has to

be calculated as the 5 V DC bus can only support a limited number of expansion I/O (for further details please refer to next page – calculation of the power consumption).

### Special Function Modules

A wide variety of special function modules are available for the FX1N, FX3G, FX3U and FX3UC PLCs. They cover networking functionality, analog control, pulse train outputs, data logging function and temperature inputs.

### Memory extension and operator terminals

Each FX family base unit can be equipped with a memory cassette. The programming unit interface enables the connection of programming tools like PC and hand held programming units as well as graphical operator terminals.

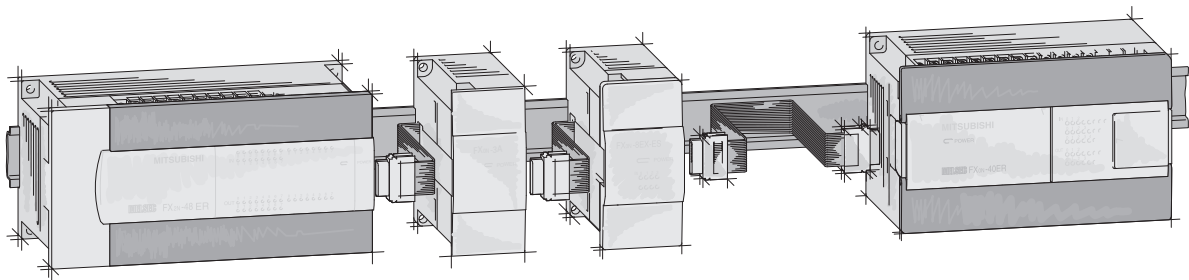

Expansion possibilities		ALPHA2	FX1S	FX1N	FX3G	FX3U	FX3UC	Reference page
Extensions for inside PLC installation	Digital	●	●	●	●	●	●	11, 45
	Analog	●	●	●	●	●	●	11, 46
Extension modules (installation outside the PLC)	Digital	—	—	●	●	●	●	29
	Analog	—	—	●	●	●	●	33
	Temperature	●	—	●	●	●	●	11, 34
Network modules	AS-Interface	●	—	●	—	●	●	12, 39
	CC-Link	—	—	●	●	●	●	38
	CAN open	—	—	●	●	●	●	43
	Ethernet	—	●	●	●	●	●	40
	Profibus/DP	—	—	●	●	●	●	41
	DeviceNet	—	—	—	—	●	●	43
	Modbus RTU/ASCII	—	—	—	①	●	●	44
	SSCNET	—	—	—	—	●	●	37
Communications boards	RS232	●	●	●	●	●	—	48
	RS422	—	●	●	●	●	—	48
	RS485	—	●	●	●	●	—	48
	USB	—	—	—	—	●	—	47
Communications modules	RS232	—	●	●	●	●	●	44
	RS485	—	●	●	●	●	●	44
Dedicated function modules	High speed counter	—	—	—	—	●	●	36
	Positioning	—	—	—	—	●	●	37
Memory cassettes	●	●	●	●	●	●	12, 49	
External Display	—	●	●	●	●	—	54	

① only via IEC function blocks



### Calculation of the Power Consumption

The power consumption figures on the 5 V DC bus for the special function modules are shown in the specifications tables on the following pages.

The maximum permissible currents on the 5 V DC and 24 V DC bus are shown in the table below.

Modules	Max. current	
	5 V bus	24 V bus
FX3G-14/24M□-ES(ESS)	—	400 mA
FX3G-40/60M□-ES(ESS)	—	400 mA
FX3U-16/32M□-ES(ESS)	500 mA	400 mA
FX3U-48-128M□-ES(ESS)	500 mA	600 mA
FX3UC-16MT/D(DSS)	600 mA	—
FX3UC-32MT/D(DSS)	560 mA	—
FX3UC-64MT/D(DSS)	480 mA	—
FX3UC-96MT/D(DSS)	400 mA	—

The residual currents for the 24 V DC service voltage at different input/output configurations are shown in the tables on the right.

A maximum of 256 I/Os are possible for FX3U/FX3UC (128 I/Os for FX3G).

Max. residual current values (in mA) for FX3U-16M□-E□□ through FX3U-32M□-E□□ for the permissible configuration

Number of additional outputs	40	25								
	32	100	50	0						
	24	175	125	75	25					
	16	250	200	150	100	50	0			
	8	325	275	225	175	125	75	25		
	0	400	350	300	250	200	150	100	50	0
		0	8	16	24	32	40	48	56	64
		Number of additional inputs								

Max. residual current values (in mA) for FX3U-48M□-E□□ through FX3U-128M□-E□□ for the permissible configuration

Number of additional outputs	64	0																	
	56	75	25																
	48	150	100	50	0														
	40	225	175	125	75	25													
	32	300	250	200	150	100	50	0											
	24	375	325	275	225	175	125	75	25										
	16	450	400	350	300	250	200	150	100	50	0								
	8	525	475	425	375	325	275	225	175	125	75	25							
	0	600	550	500	450	400	350	300	250	200	150	100	50	0					
		0	8	16	24	32	40	48	56	64	72	80	88	96					
		Number of additional inputs																	

An external power supply is necessary, if the residual current for the 24 V supply of the special function modules is not sufficient.

### Sample Calculations

The tables below and on the right show different examples for sample power calculation for a PLC system.

The current values for the special function modules can be found in the specifications on the following pages.

Comparison with the current value tables show that the calculated figures for the 5 V bus lie within the allowable ranges.

In the example below all units can be supplied sufficiently with the internal 24 V power supply.

Module	No.	24 V DC calculation		5 V DC calculation	
		Current / module	Calculation	Current / module	Total current
FX3U-80MR/ES	1	600 mA	+600 mA	+500 mA	+500 mA
FX3U-4AD	3	90 mA	-180 mA	110 mA	-220 mA
FX3U-4DA	2	160 mA	-320 mA	120 mA	-240 mA
FX3U-ENET	1	240 mA	-240 mA	—	—
			<b>-140 mA !!!</b>		<b>500 – 460 mA</b>
				Result:	<b>40 mA (OK !)</b>

An external 24 V power supply has to be added in the example above.

Module	No.	Number of I/Os			24 V DC calculation		5 V DC calculation		
		X	Y	X/Y	Total ①	Total current ②	Current / module	Total current	
FX3U-48MR/ES	1	24	24	—	X = 8 Y = 24 →	+325 mA	500 mA	+500 mA	
FX2N-16EYR-ES/UL	1	—	16	—			—	0 mA	
FX2N-8EX-ES/UL	1	8	—	—			—	0 mA	
FX2N-8EYR-ES/UL	1	—	8	—			—	0 mA	
FX3U-4AD-PT-ADP	1	—	—	—		-50 mA	30 mA	-15 mA	
						<b>+275 mA (OK!)</b>		<b>+485 mA (OK!)</b>	
FX2N-32ER-ES/UL	1	16	16	—	X = 16 Y = 0 →	+150 mA residual current for extension unit FX2N-32ER-ES/UL	690 mA	+690 mA	
FX2N-16EX-ES/UL	1	16	—	—			—	0 mA	
FX2N-10PG	1	—	—	8			0 mA	120 mA	-120 mA
FX2N-32CCL	1	—	—	8			-50 mA	130 mA	-130 mA
Result:		<b>64 + 64 + 16 = 144! (&lt; 256) OK!</b>				<b>+100 mA (OK!)</b>		<b>+440 mA (OK!)</b>	

① Total no. of I/Os which are connected to a base unit to calculate the max. residual current values (see tables) ② see tables above (max. residual current values)

**The ALPHA 2 Series**

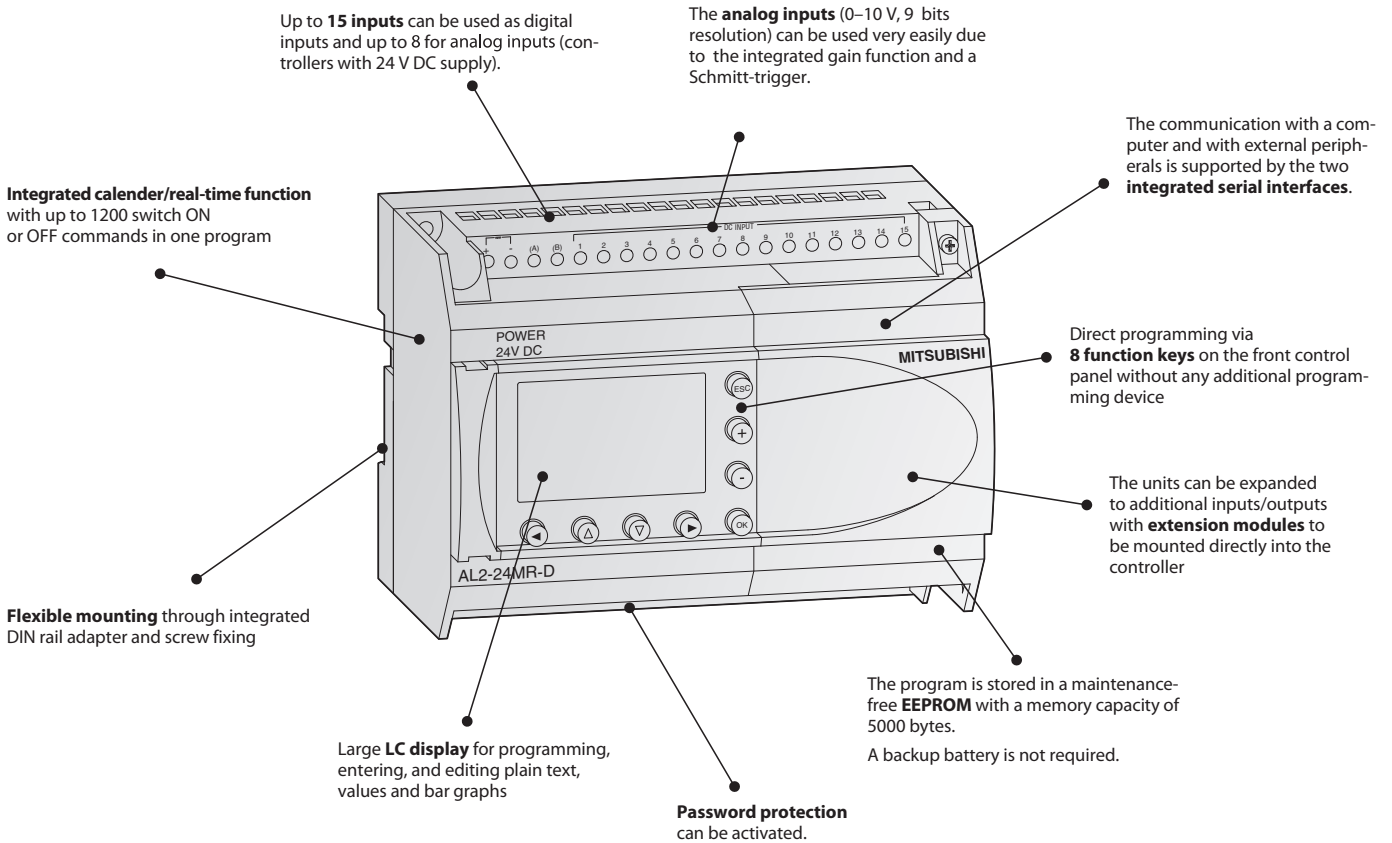

**Description of the Unit Components**

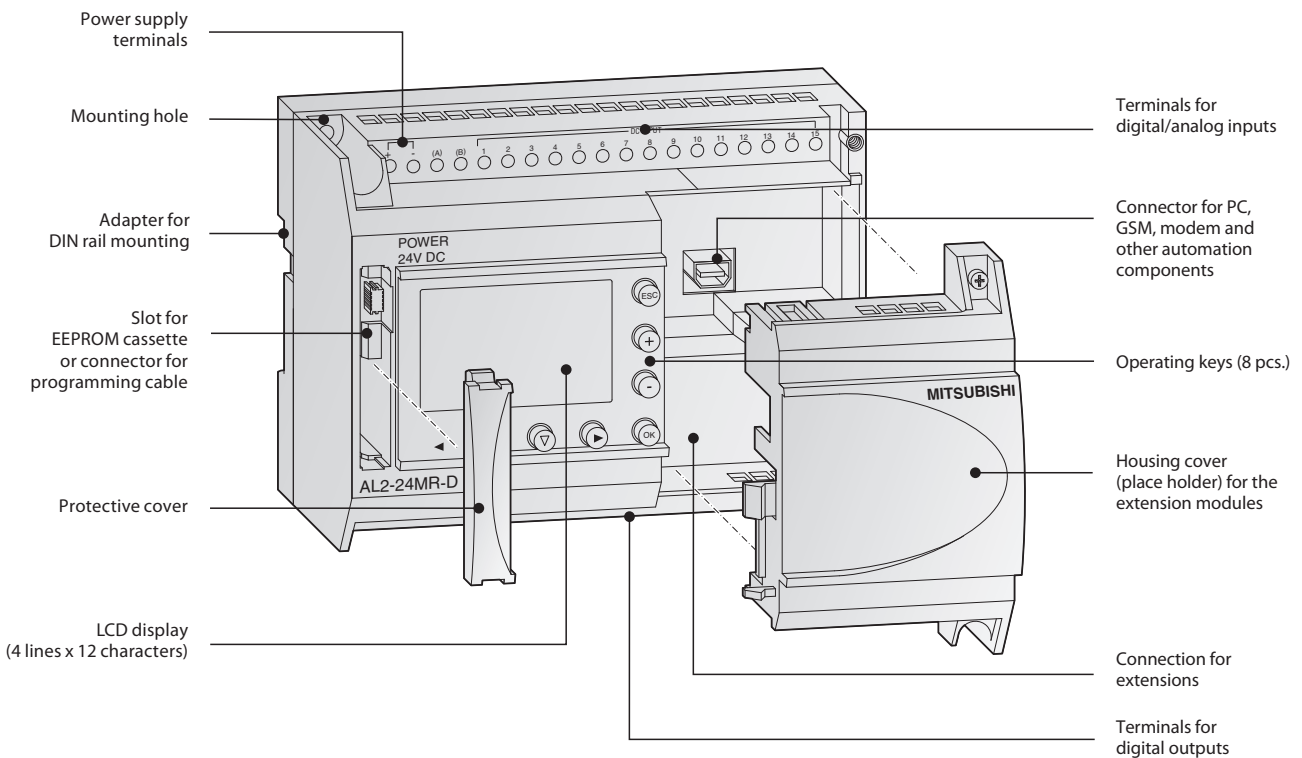

## Specifications ALPHA 2

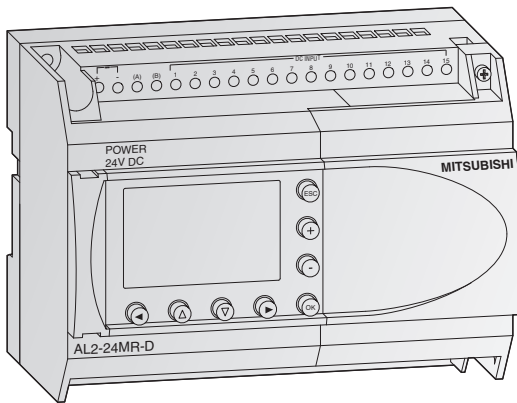

e.g. AL2-24M□-□

### ALPHA 2 Base Units

The ALPHA 2 controllers offer simple reliable control for a range of automation applications including lighting, air conditioning, security systems, and temperature and water control.

#### Special features:

- Transistor and relay output options
- Analog input/output
- High Speed counters up to 1 kHz
- GSM function for communication with mobile phones
- Language support for 8 different languages
- Display unit for messages and function block data

## Base Units with 10–24 I/Os

Specifications		AL2-10MR-A	AL2-10MR-D	AL2-14MR-A	AL2-14MR-D	AL2-24MR-A	AL2-24MR-D
<b>Electrical specifications</b>							
Integrated inputs/outputs		10	10	14	14	24	24
Power supply		100–240 V AC	24 V DC	100–240 V AC	24 V DC	100–240 V AC	24 V DC
Digital inputs		6	6	8	8	15	15
Analog inputs		—	6	—	8	—	8
Channels		—	6	—	8	—	8
Integrated outputs		4	4	6	6	9	9
Max. power consumption	W	4.9	4.0	5.5	7.5	7.0	9.0
Typ. power consumption	All I/Os ON/OFF	3.5/1.85 240 V AC 3.0/1.55 120 V AC	2.5/0.75	4.5/2.0 240 V AC 3.5/1.5 120 V AC	4.0/1.0	5.5/2.5 240 V AC 4.5/2.0 120 V AC	5.0/1.0
Weight	kg	0.2	0.2	0.3	0.3	0.35	0.3
Dimensions (WxHxD)	mm	71.2x90x55	71.2x90x55	124.6x90x52	124.6x90x52	124.6x90x52	124.6x90x52
<b>Order information</b>	Art. no.	215070	215071	215072	215073	215074	215075
<b>Accessories</b>		Power supplies with DIN-rail or wall mounting possibilities for powering the 24 V DC modules (refer to the power supply chapter in this catalogue)					

## Environmental Specifications

General specifications		Alpha 2 series
Ambient temperature	Display: -10–55 °C, Hardware: -25–55 °C (storage temperature: -30–+70 °C)	
Protection rating	IP20	
Noise immunity	1000 Vpp with noise generator; 1 µs at 30–100 Hz, tested by noise simulator	
Dielectric withstand voltage	3750 V AC, >1 min. according to EN60730	
Allowable relative humidity	35–85 % (no condensation)	
Shock resistance	Acc. to IEC 68-2-27: 147 m/s <sup>2</sup> acceleration, 11 ms 3x3 directions	
Vibration resistance	direct mounting	Acc. to IEC-2-6: 19.6 m/s <sup>2</sup> acceleration, 80 min. in each direction
	DIN rail mounting	Acc. to IEC-2-6: 9.8 m/s <sup>2</sup> acceleration, 80 min. in each direction
Insulation resistance	500 V DC, 7 MΩ acc. to EN60730-1	
Ambient conditions	No corrosive gases, no dust	
Certifications	Please refer to pages 66–67 in this catalogue	

## Electrical Specifications

Power supply specifications	DC powered modules (AL2-□MR-D)	AC powered modules (AL2-□MR-A)
Power supply	24 V DC	100–240 V AC (50/60 Hz)
Inrush current at ON	≤7.0 A (at 24 V DC)	≤6.5 A (at 240 V AC)
Allowable momentary power failure time	5 ms	10 ms

### Digital Inputs

Input voltage	24 V DC (+20 %/-15 %)	100–240 V AC (+10 %/-15 %), 50/60 Hz
Input current	The input current changes depending on Source or Sink. For Sink: (AL2-10/14/24MR-D) = 5.5 mA, 24 V DC For Source: (AL2-10/14MR-D) = 6.0 mA, 24VDC (AL2-24MR-D) = 5.5 mA, 24 V DC	
Response time	OFF→ON	ms 10–20
	ON→OFF	ms 10–20

### Analog Inputs

Analog input range	0–500	—
Resolution	9 bit, (10 V/500)	—
Conversion speed	ms 8	—
Voltage	0–10 V DC	—
Impedance	kΩ 142 ±5 %	—
Accuracy	±5 % (0.5 V DC)	—

\* Current leakage from the sensors connected to the inputs might provide enough current to turn the controller On. Do not use two wire sensors

Output specifications		All modules
Type	Relay	
Switching voltage (max.)	V	250 V AC, 30 V DC
Rated current	10M, 14M: 8 A/point 24M (001-004): 8 A/point 24M (005-009): 2 A/point	
Max. switching load	- inductive load	14M, 24M: 249 VA, 250 V AC/373 VA, 250 V AC 24M: 93 VA, 125 V AC/93 VA, 250 V AC
Minimum load	10 mA, 5 V DC	
Response time	ms	≤10

## Programming Specifications

System specifications	Alpha 2 series
Programming method	Function block
Program capacity	200 function blocks or 5000 bytes
Program processing	Cyclic processing of the stored program
Number of available instructions	38 different function blocks
Program storage	Integrated EEPROM and optional additional EEPROM cassette
Data storage	At voltage loss the current status of values, running time meters, and real-time data are stored for up to 20 days (at temperatures of 0 to 25 °C) through integrated capacitors
Processing time	1 ms + 20 µs/log. instruction (complex commands 500 µs/instruction)
Real-time clock	Seconds, minutes, hours, day of week, month, year (4-digit); accuracy: 5 s/day; automatic summer and winter time toggling
Program protection	Program and keys (3 levels)

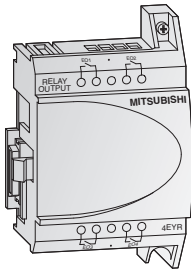

### Digital Extension Modules

There are 4 different extension modules available for the ALPHA 2, which allow the controller to be extended through additional inputs or outputs. The modules are inserted directly into the ALPHA 2 and therefore do not take up any additional space.

The AL2-4EX has the additional feature that 2 inputs may be used as high-speed counters with a counting frequency of 1 kHz.

All modules feature photocoupler insulation for all I/Os.

*Note: The digital extension modules cannot be used with the AL2-10MR series.*

Digital extension modules specifications	AL2-4EX-A2	AL2-4EX	AL2-4EYR	AL2-4EYT
<b>Inputs</b>				
Integrated inputs	4	4	—	—
Input voltage	220–240 V AC	24 V DC (+20 %, -15 %)	—	—
Input current	7.5 mA at 240 V AC (50 Hz), 9.0 mA at 240 V AC (60 Hz)	5.4 mA ± 1 mA at 24 V DC	—	—
<b>Outputs</b>				
Integrated outputs	—	—	4	4
Output type	—	—	Relay	Transistor
Switched voltage (max.)	V	—	250 V AC, 30 V DC	5–24 V DC
Rated current	A	—	2 A per output	1 A per output
<b>Electrical specifications</b>				
Power Supply AC range (+10 %, -15 %)	220–240 V AC	24 V DC	100–240 V AC	24 V DC
<b>Mechanical specifications</b>				
Weight	kg	0.05	0.05	0.05
Dimensions (WxHxD)	mm	53.1x90x24.5	53.1x90x24.5	53.1x90x24.5
<b>Order information</b>				
Art. no.	142522	142521	142523	142524

*Note: EI1 and EI2 of the AL2-4EX can be used as high-speed counter inputs. In each case the response time for the high-speed counter inputs will be 0.5 ms or less. The AL2-4EX-A2, AL2-4EX, AL2-4EYR and AL2-4EYT modules can not be used with the AL2-10MR series.*

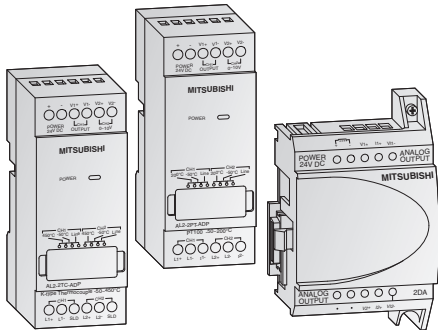

### Analog Extension Modules

The analog extension modules significantly increase the range of applications for the ALPHA 2. With these modules it is possible to output voltage or current signals or to measure temperatures.

Three different analog extension modules are available:

- The AL2-2DA offers two additional analog outputs for the ALPHA 2 and converts a digital input value into a voltage or a current. This module is inserted directly into the ALPHA 2.

*Note: the AL2-2DA cannot be used with the AL2-10MR series.*

- The AL2-2PT-ADP connects an external PT100 sensor to convert temperature readings into analog signals (0–10 V).
- The AL2-2TC-ADP connects thermocouple sensors (K type) to convert temperature readings into analog signals (0–10 V).

Analog extension modules specifications	AL2-2DA	AL2-2PT-ADP	AL2-2TC-ADP
<b>Analog inputs</b>			
Integrated inputs	—	2	2
Connectable temperature sensors	—	PT100 sensor Temp. coefficient 3.850 ppm/°C (IEC 751)	Thermocouple (K type), isolated type (IEC 584-1 1977, IEC 584-2 1982)
Compensated range	—	-50–+200 °C	-50–+450 °C
<b>Analog outputs</b>			
Integrated outputs	2	—	—
Analog output voltage range	0–10 V DC (5 kΩ 1 MΩ)	—	—
Analog output current range	4–20 mA (max. 500 Ω)	—	—
<b>Electrical specifications</b>			
Number of channels	2	2	2
Power Supply	24 V DC (-15–+10 %), 70 mA	24 V DC (-15–+20 %), 1 W	24 V DC (-15–+20 %), 1 W
<b>Mechanical specifications</b>			
Weight	kg	0.05	0.07
Dimensions (WxHxD)	mm	53.1x90x24.5	35.5x90x32.5
<b>Order information</b>			
Art. no.	151235	151238	151239

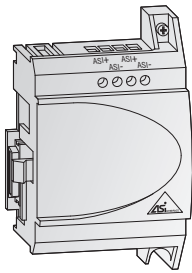

**AS-Interface Module AL2-ASI-BD**

The Actuator Sensor Interface module AL2-ASI-BD in combination with an ALPHA 2 controller facilitates the data communications via an AS-Interface system. The AL2-ASI-BD is attached to an ALPHA 2 series module and forms a slave unit. Up to 4 inputs and 4 outputs can be exchanged with the AS-Interface master.

The addresses of the slave devices in the AS-Interface are assigned either automatically via the master in the network or via a programming device (software).

The maximum communication distance is 100 m without a repeater. If 2 repeaters are used, the distance is extended to up to 300 m.

For the AS-Interface a separate power supply is required. The communication signal is superimposed on the power supply of the AS-Interface bus.

*Note: The AL2-ASI-BD cannot be used with the AL2-10MR series.*

Specifications	AL2-ASI-BD
Module type	Slave module
Number of I/O points	4 inputs, 4 outputs
External power supply	30.5 V DC (AS-Interface power supply)
External current consumption	mA Max. 40
Communications protocol	AS-Interface standard
Weight	kg 0.05
Dimensions (WxHxD)	mm 53.1x90x24.5
<b>Order information</b>	Art. no. 142525

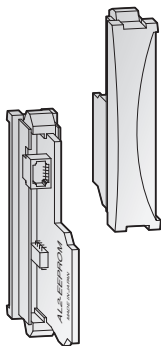

**Memory Cassette AL2-EEPROM-2 Memory Media**

With the AL2-EEPROM-2 memory cassettes, a new program can be transferred to the ALPHA 2 controller's internal system memory from the cassette, or the program of the internal system memory can be saved to the cassette.

If the memory cassette is used, a certain program can be run temporarily by simply plugging the external memory module onto the ALPHA 2.

After removing the memory cassette, the former program in the internal memory becomes active again.

The memory cassette AL2-EEPROM-2 is not a memory expansion device, but a medium for data exchange.

Specifications	AL2-EEPROM-2
Memory type	EEPROM
Application	ALPHA 2
Memory capacity	5,000 bytes
Function blocks	Max. 200
Dimensions (WxHxD)	mm 10x45x25
<b>Order information</b>	Art. no. 142526

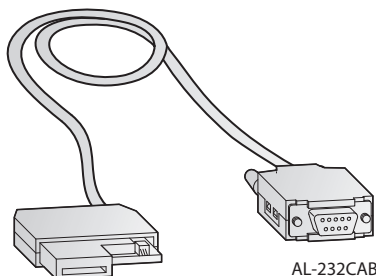

AL-232CAB

**Interface Cable AL-232CAB**

The AL-232CAB is an RS232C interface cable. It connects the ALPHA 2 controller to a personal computer running the programming software for the ALPHA 2 controller.

The cable ensures a galvanic isolation between the ALPHA 2 controller and the personal computer. The cable AL-232CAB can not be used for any other connection.

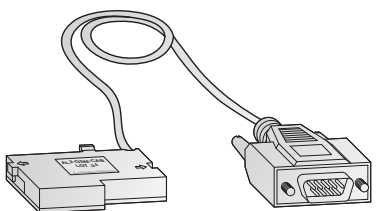

AL2-GSM-CAB

**GSM Cable AL2-GSM-CAB**

The GSM AL2-GSM-CAB is an RS232C interface cable and it is used to connect the ALPHA 2 controller to a normal or GSM modem, a personal computer or other serial devices. It can transfer SMS data to a GSM modem for onward transmission to mobile telephones or e-mail addresses. It also permits remote monitoring and remote maintenance.

*Note: The above cables cannot be used with the AL2-10MR series.*

Specifications	AL-232CAB	AL2-GSM-CAB
Connector	9-pin D-SUB female connector	9-pin D-SUB male connector
Application	ALPHA 2 <-> PC	ALPHA 2 <-> PC, modem
Length	m 2.5	1.5
<b>Order information</b>	Art. no. 87674	142528

The MELSEC FX1s Series

**High-speed inputs** for fast counting tasks with counting frequencies of up to 60 kHz and **interrupt processing capabilities**

The **internal service power supply unit** for 24 V DC has a capacity of 400 mA.  
Note: service power supply is only available for AC Power Supply types.

All units feature two **analog potentiometers** for setpoint value entry and an **integrated RUN/STOP switch**.

**Square pulse output** (this applies only to transistor units.)  
Two integrated **high speed pulse outputs** for frequencies up to 100 kHz for outputting pulse signals and controlling stepping motors

Integration of **interface, extension, and functions adapters** for direct installation in the base unit

**Integrated real-time clock** with year, month, day and time

**Integrated serial RS422 interface** for direct communication with computers

Your PLC programs are stored in a maintenance-free **EEPROM user memory** with a capacity of 2,000 program steps, so there is no need for a backup battery to protect against power failures.

**Flexible installation** with the integrated DIN rail adapter and screw fastening holes for mounting on flat surfaces

**Password access protection** facility for effective protection of your intellectual property.

Description of the Unit Components

Protective cover

Terminal cover

Fixing hole

Connection of the power supply

Adapter interface

Slot for adapter

2 analog potentiometers

Connection for programming units

Service voltage source

Terminals for digital outputs

Terminals for digital inputs

LEDs for indicating the input status

RUN/STOP switch

LEDs for indicating the operating status

LEDs for indicating the output status

Housing cover

Base Units

FX1S  FX1N  FX3G  FX3U  FX3UC

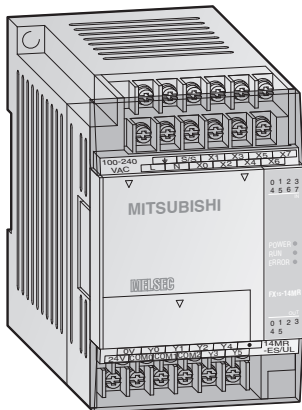

**Base Units FX1S**

The FX1S series base units are available with 10 to 30 input/output points.

It is possible to choose between relay and transistor output type.

*Note: Versions with UL certification are available on request.*

**Special Features:**

- Integrated power supply (AC or DC powered)
- Maintenance-free EEPROM memory
- Ample memory capacity (2000 steps) and device ranges
- High-speed operations
- Incorporated positioning control
- Integrated real-time clock
- System upgrades by exchangeable interface and I/O adapter boards for direct fitting into the base unit
- LEDs for indicating the input and output status
- Standard programming unit interface
- User-friendly programming systems, including IEC 61131.3 (EN 61131.3)-compatible programming software, HMI's and hand-held programming units

**Base Units with 10–14 I/Os**

Specifications	FX1S-10 MR-DS	FX1S-10 MR-ES/UL	FX1S-10 MT-DSS	FX1S-14 MR-DS	FX1S-14 MR-ES/UL	FX1S-14 MT-DSS
Max. number inputs/outputs	10	10	10	14	14	14
Power supply	24 V DC	100–240 V AC	24 V DC	24 V DC	100–240 V AC	24 V DC
Integrated inputs	6	6	6	8	8	8
Integrated outputs	4	4	4	6	6	6
Output type	Relay	Relay	Transistor (source)	Relay	Relay	Transistor (source)
Power consumption	W	6	19	6	6.5	19
Weight	kg	0.22	0.3	0.22	0.22	0.3
Dimensions (WxHxD)	mm	60x90x49	60x90x75	60x90x49	60x90x75	60x90x49
<b>Order information</b>	Art. no.	141240	141243	141246	141247	141248

**Base Units with 20–30 I/Os**

Specifications	FX1S-20 MR-DS	FX1S-20 MR-ES/UL	FX1S-20 MT-DSS	FX1S-30 MR-DS	FX1S-30 MR-ES/UL	FX1S-30 MT-DSS
Max. number inputs/outputs	20	20	20	30	30	30
Power supply	24 V DC	100–240 V AC	24 V DC	24 V DC	100–240 V AC	24 V DC
Integrated inputs	12	12	12	16	16	16
Integrated outputs	8	8	8	14	14	14
Output type	Relay	Relay	Transistor (source)	Relay	Relay	Transistor (source)
Power consumption	W	7	20	7	8	21
Weight	kg	0.3	0.4	0.3	0.35	0.45
Dimensions (WxHxD)	mm	75x90x49	75x90x75	75x90x49	100x90x75	100x90x49
<b>Order information</b>	Art. no.	141251	141252	141254	141255	141257



■ Base Units

FX1S  FX1N  FX3G  FX3U  FX3UC

**Environmental Specifications**

General specifications	Data
Ambient temperature	0–55 °C (storage temperature: -20–+70 °C)
Protection	IP10
Noise durability	1000 Vpp with noise generator; 1 μs at 30–100 Hz
Dielectric withstand voltage	1,500 V AC, 1 min. (500 V AC for direct voltage modules)
Ambient relative humidity	35–85 % (non-condensing)
Shock resistance	Acc. to IEC/EN 68-2-27: 15G (3 times each in 3 directions for 11 ms)
Vibration resistance	Acc. to IEC/EN 68-2-6: 1G (resistance to vibrations from 57–150 Hz for 80 minutes along all 3 axes); 0.5G for DIN rail mounting
Insulation resistance	500 V DC, 5 MΩ
Ground	Class D: Grounding resistance 100 Ω or less
Fuse rating	AC models: 250 V 1.0 A; DC models: 0.8 A
Environment	Avoid environments containing corrosive gases, install in a dust-free location.
Certifications	Please refer to pages 66–67 in this catalogue

**Electrical Specifications**

Power supply specifications	DC powered modules (FX1S-□M□-DS/-DSS)	AC powered modules (FX1S-□M□-ES/UL)
Power supply	24 V DC (+10 %/-15 %)	100–240 V AC (+10 %/-15 %), 50/60 Hz (±10 %)
Inrush current at ON	10 A/0.1 ms (at 24 V DC)	15 A/5 ms (at 100 V AC); 25 A/5 ms (at 200 V AC)
Allowable momentary power failure time	5 ms	10 ms
Primary power supply	24 V DC, 400 mA	
External power supply (24 V DC)	—	400 mA

Output specifications	Relay modules	Transistor modules
Switching voltage (max.)	V <250 V AC, <30 V DC	5–30 V DC
Max. output current	- per output	0.5
	- per group*	0.8
Max. switching current	- inductive load	12 W
	- lamp load	1.2
Response time	ms 10	0.2
Life of contacts (switching times)**	3,000,000 at 20 VA; 1,000,000 at 35 VA; 200,000 at 80 VA	

\* The limitation applies only per reference terminal for each group, 1 and 4 outputs for relays and transistors. Please observe the terminal assignments for the group identification.

\*\* Not guaranteed by Mitsubishi Electric.

**Programming Specifications**

System specifications	FX1S
<b>Program data</b>	
Program memory	2,000 steps EEPROM (internal)
Program execution	Periodical execution of the stored program
Program protection	Password protection with 3 protection levels. Note: Protection levels may only be changed with FX-10P/FX-20P/FX-30P.
Number of instructions	27 sequence instructions, 2 step ladder instructions, 85 applied instructions
Cycle period	0.55–0.7 μs/logical instruction
<b>Operands</b>	
Internal relays	512 total, with 384 general (M0–M383) and 128 latched (M384–M511)
Special relays	256 (M8000–M8255)
State relays	128
Timers	64 (max. 63 timers, partially switchable to 100 ms and 10 ms)
External setpoint entry via potentiometer	2 potentiometers
Counter	32 (16 bit), C0–C31
High-speed counter inputs	1 phase, 6 points max: 60kHz/2 points, 10kHz/4 points ; 2 phase, 2 points max: 30kHz/1 point, 5kHz/1 point
Data register	256 subtotal (128 general (D0–D127) and 128 latched (D128–D255))
Index register	16
Special register	256 (16 bit), D8000–D8255
Pointer	64, P0–P63
Nesting operands	8, N0–N7
Interrupt inputs	6
Constants	16 bits: K: -32768 to +32767, hex: 0–FFFF 32 bits: K: -2147483648 to +2147483647, hex: 0–FFFF FFFF

The MELSEC FX1N Series

2  
FX BASE UNITS

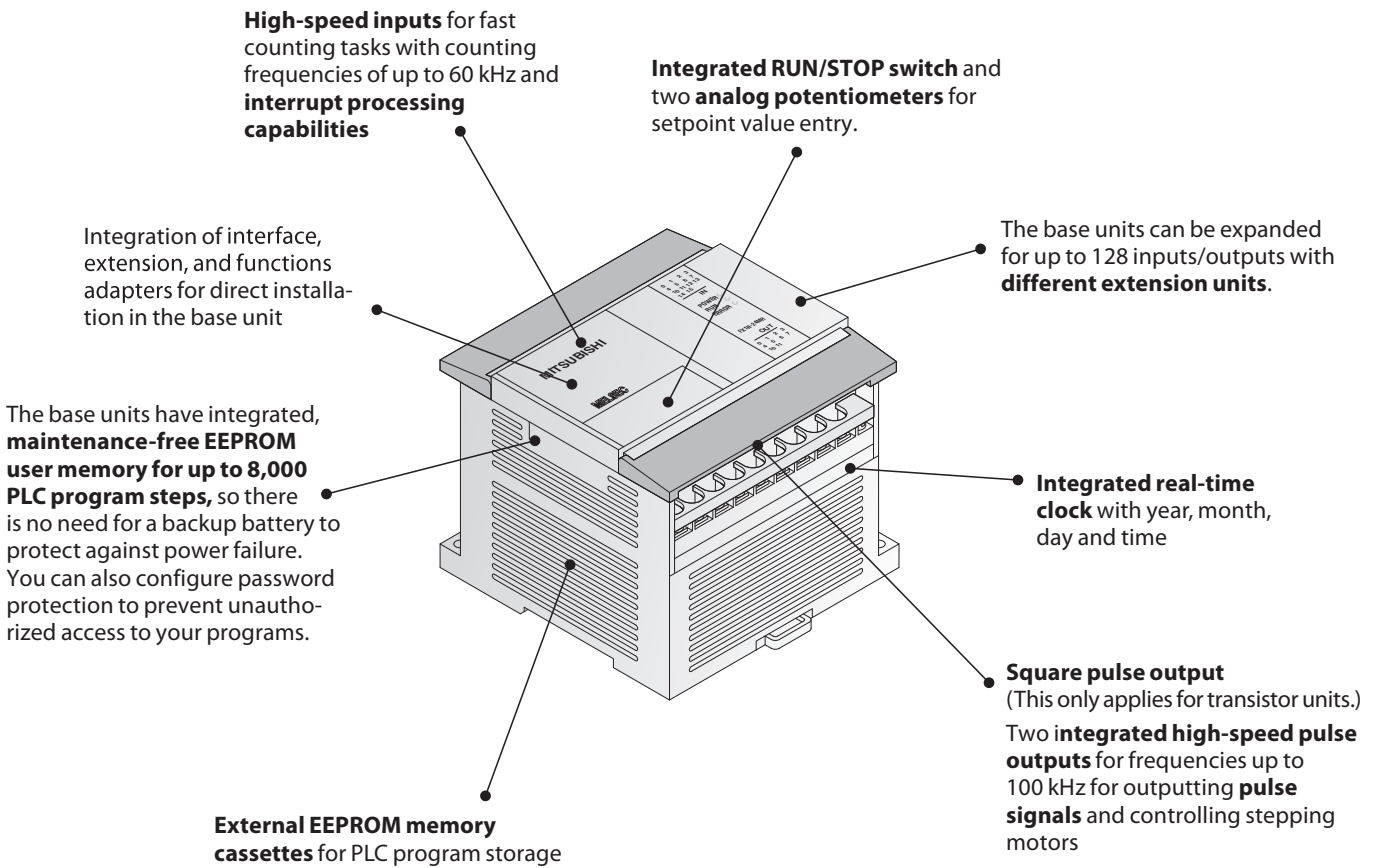

Description of the Unit Components

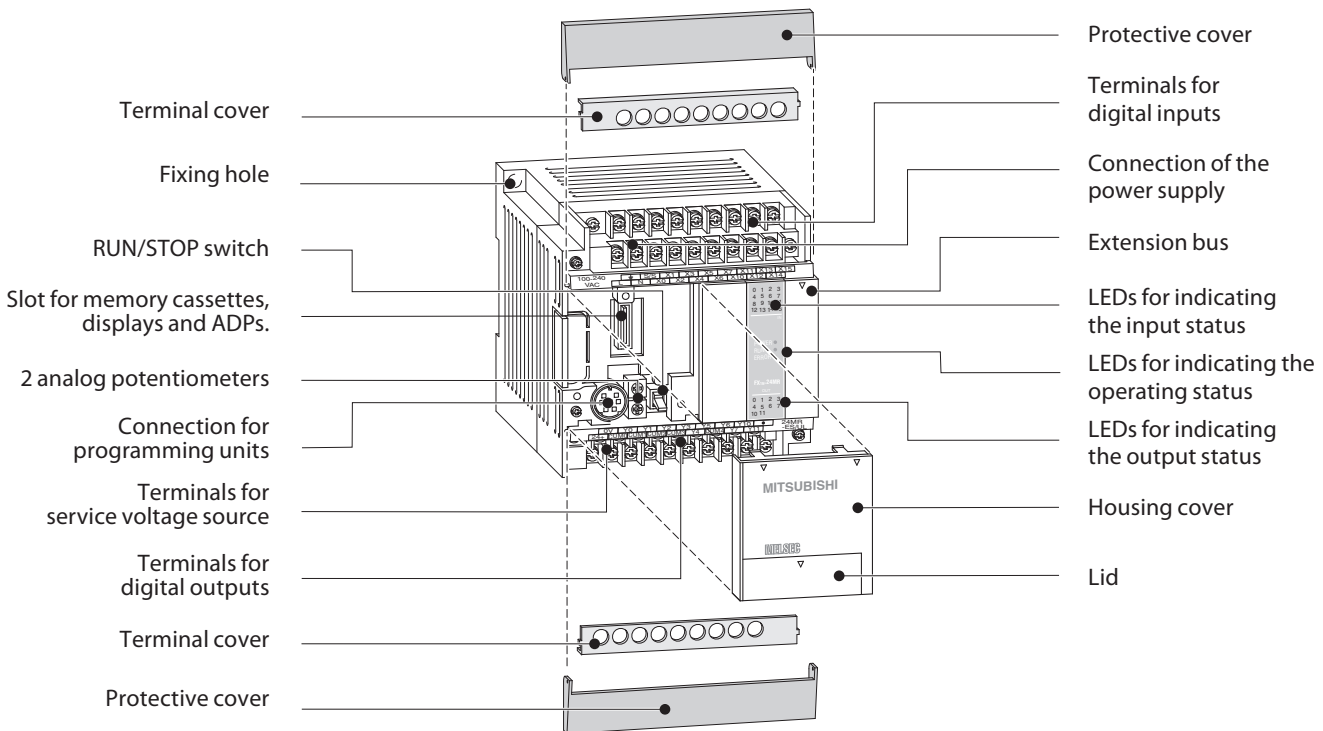

■ Base Units

FX1S  FX1N  FX3G  FX3U  FX3UC

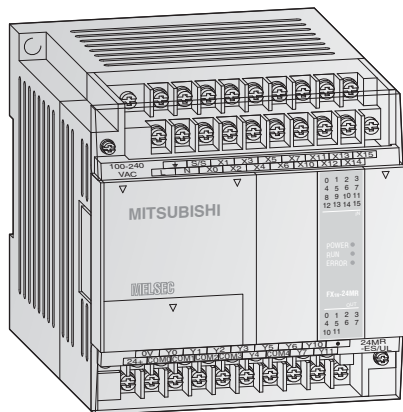

**Base Units FX1N**

The FX1N series base units are available with 14 to 60 input/output points.

It is possible to choose between relay and transistor output type.

*Note: Versions with UL certification are available on request.*

**Special Features:**

- Integrated serial interface for communication between Personal computers and HMI
- Standard programming unit interface
- LEDs for indicating the input and output status
- Detachable terminal blocks for units with 14, 24, 40, and 60 I/Os.
- Slot for memory cassettes
- All DC models with variable voltage from 12 up to 24 V
- Integrated real-time clock
- Exchangeable interface and I/O adapter boards for direct fitting into the base unit

2  
FX BASE UNITS

**Base Units with 14–24 I/Os**

Specifications	FX1N-14 MR-DS	FX1N-14 MR-ES/UL	FX1N-14 MT-DSS	FX1N-24 MR-DS	FX1N-24 MR-ES/UL	FX1N-24 MT-DSS
Integrated inputs/outputs	14	14	14	24	24	24
Power supply	12–24 V DC	100–240 V AC	12–24 V DC	12–24 V DC	100–240 V DC	12–24 V DC
Integrated inputs	8	8	8	14	14	14
Integrated outputs	6	6	6	10	10	10
Output type	Relay	Relay	Transistor (source)	Relay	Relay	Transistor (source)
Power consumption	W 13	29	13	15	30	15
Weight	kg 0.45	0.45	0.45	0.45	0.45	0.45
Dimensions (WxHxD)	mm 90x90x75	90x90x75	90x90x75	90x90x75	90x90x75	90x90x75
<b>Order information</b>	Art. no. 141258	141259	141260	141261	141262	141263

**Base Units with 40–60 I/Os**

Specifications	FX1N-40 MR-DS	FX1N-40 MR-ES/UL	FX1N-40 MT-DSS	FX1N-60 MR-DS	FX1N-60 MR-ES/UL	FX1N-60 MT-DSS
Integrated inputs/outputs	40	40	40	60	60	60
Power supply	12–24 V DC	100–240 V AC	12–24 V DC	12–24 V DC	100–240 V AC	12–24 V DC
Integrated inputs	24	24	24	36	36	36
Integrated outputs	16	16	16	24	24	24
Output type	Relay	Relay	Transistor (source)	Relay	Relay	Transistor (source)
Power consumption	W 18	32	18	20	35	20
Weight	kg 0.65	0.65	0.65	0.8	0.8	0.8
Dimensions (WxHxD)	mm 130x90x75	130x90x75	130x90x75	175x90x75	175x90x75	175x90x75
<b>Order information</b>	Art. no. 141264	141265	141266	141267	141268	141269

■ Base Units  FX1S  **FX1N**  FX3G  FX3U  FX3UC

## Environmental Specifications

General specifications	Data
Ambient temperature	0–55 °C (storage temperature: –20–+70 °C)
Protection	IP10
Noise durability	1000 Vpp with noise generator; 1 μs at 30–100 Hz
Dielectric withstand voltage	1,500 V AC, 1 min. (500 V AC for direct voltage modules)
Ambient relative humidity	35–85 % (non-condensing)
Shock resistance	Acc. to IEC 68-2-27: 15G (3 times each in 3 directions for 11 ms)
Vibration resistance	Acc. to IEC 68-2-6: 1G (resistance to vibrations from 57–150 Hz for 80 minutes along all 3 axes); 0.5G for DIN rail mounting
Insulation resistance	500 V DC, 5 MΩ
Ground	Class D: Grounding resistance 100 Ω or less
Fuse rating	AC units: From FX1N-14M□ to FX1N-24M□: 250 V AC 1.0 A; From FX1N-40M□ to FX1N-60M□: 250 V AC 3.15 A/DC units: 125 V DC 3.15 A
Environment	Avoid environments containing corrosive gases, install in a dust-free location.
Certifications	Please refer to pages 66–67 in this catalogue

## Electrical Specifications

Power supply specifications	DC powered modules (FX1N-□M□-DS/-DSS)	AC powered modules (FX1N-□M□-ES/UL)
Power supply	12–24 V DC (+20 %/-15 %)	100–240 V AC (+10 %/-15 %), 50/60 Hz (±10 %)
Inrush current at ON	25 A/1 ms (at 24 V DC); 22 A/0.3 ms (at 12 V DC)	30 A/5 ms (at 100 V AC); 50 A/5 ms (at 200 V AC)
Allowable momentary power failure time	5 ms	10 ms
Primary power supply	24 V DC, 400 mA	
External power supply (24 V DC)	—	400 mA

Output specifications	Relay modules	Transistor modules
Switching voltage (max.)	V <240 V AC, <30 V DC	5–30 V DC
Max. output current	- per output	0.5
	- per group	0.8
Max. switching current - inductive load	80 VA	12 W
Response time	ms 10	<0.2 (Y0, Y1 <5 μs)
Life of contacts (switching times)*	3,000,000 at 20 VA; 1,000,000 at 35 VA; 200,000 at 80 VA	

\* Not guaranteed by Mitsubishi Electric.

## Programming Specifications

System specifications	FX1N
<b>Program data</b>	
I/O points (addresses)	128 (+4 optional)
Address range	Max. 128 inputs X0–X177, max. 128 outputs Y0–Y177
Program memory	8,000 steps EEPROM (internal), exchangeable EEPROM for easy program exchange
Cycle period	0.55–0.7 μs /logical instruction
Number of instructions	27 sequence instructions, 2 step ladder instructions, 89 applied instructions
Programming language	Step ladder, instruction list, SFC
Program execution	Cyclical execution, refresh mode processing
Program protection	Password protection with 3 protection levels*

\* Protection levels may only be changed with FX-10P/FX-20P/FX-30P.

System specifications	FX1N
<b>Operands</b>	
Internal relays	1,536
Special relays	256
Step ladder	1,000
Timer	256
Ext. preset value via potentiometer	2
Counter	235
High-speed counter	1 phase, 6 points max: 60kHz/2 points, 10kHz/4 points; 2 phase, 2 points max: 30kHz/1 point, 5kHz/1 point
Real-time clock	Year, month, day, hour, minute, second, weekday
Data register	8,000
File register	Max. 7,000 (parameter editable), Total registers = 8,000
Index register	16
Special register	256
Pointer	128
Nestings	8
Interrupt inputs	6
Constants	16 bits: K: –32768 to +32767, hex: 0–FFFF; 32 bits: K: 2147483648 to +2147483647, hex: 0–FFFF FFFF

**The MELSEC FX3G Series**

**Integrated high-speed counter inputs** for processing fast input signals. For example, you can configure two 60 kHz counters and four 10 kHz counters.

**Interrupt processing** is also handled via the inputs.

RAM/EEPROM memory for up to **32,000 PLC program steps** gives you plenty of reserve, even for big, complex applications.

Add-in function boards can be installed in the PLC to provide a **second RS485/RS422/RS232 communications interface** for programming or network configurations.

Analog function boards for input and output and a function board with 8 analog potentiometers are also available as add-in.

An **integrated RUN/STOP switch** is available.

Connection possibility for special function adaptermodules

**Two integrated serial interfaces** for direct communication with computers.

The base units can be expanded to provide configurations with up to 256 inputs and outputs with **modular and compact extension units**.

**Integrated real-time clock** with year, month, day and time

Two **integrated pulse outputs** for frequencies from 2 to 100,000 Hz for controlling stepping motors and outputting **pulse-width modulated signals**.

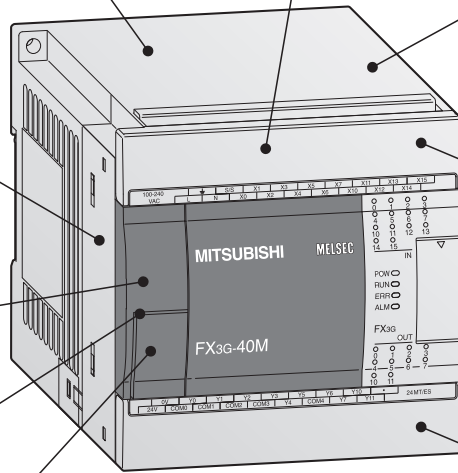

**Description of the Unit Components**

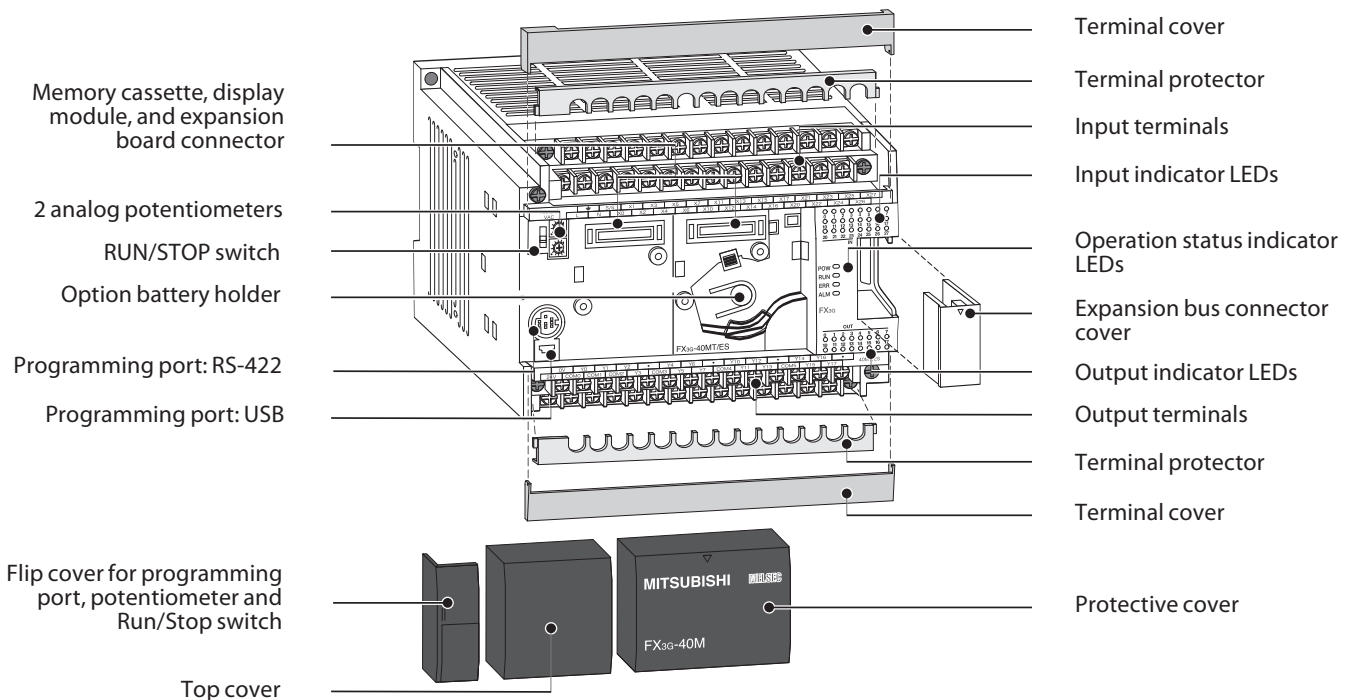

■ Base Units  FX1S  FX1N  FX3G  FX3U  FX3UC

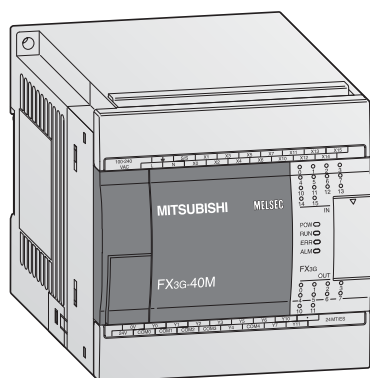

**Base Units FX3G**

The FX3G series base units are available with 14 to 60 input/output points. It is possible to choose between relay and transistor output types.

**Special features:**

- Integrated USB interface for communication between PLCs and PC
- Integrated serial interface for communication between PCs and HMI
- LEDs for indicating the input and output status
- Detachable terminal blocks for all units
- Slot for memory cassettes
- Integrated real-time clock
- Integrated positioning control
- Exchangeable interface and extension adapters for direct mounting into a base unit
- Expandable with digital I/O modules, special function modules and ADP modules
- User-friendly programming systems, including IEC 1131.3 (EN 61131.3) compatible programming software, HMIs and hand-held programming units

**Base Units with 14–24 I/Os**

Specifications	FX3G-14 MR/ES	FX3G-14 MT/ESS	FX3G-14 MR/DS	FX3G-14 MT/DSS	FX3G-24 MR/ES	FX3G-24 MT/ESS	FX3G-24 MR/DS	FX3G-24 MT/DSS	
Integrated inputs/outputs	14	14	14	14	24	24	24	24	
Power supply	100–240 V AC	100–240 V AC	24 V DC	24 V DC	100–240 V AC	100–240 V AC	24 V DC	24 V DC	
Integrated inputs	8	8	8	8	14	14	14	14	
Integrated outputs	6	6	6	6	10	10	10	10	
Output type	Relay	Transistor (source)*	Relay	Transistor (source)*	Relay	Transistor (source)*	Relay	Transistor (source)*	
Power consumption	W	31	19	19	32	32	21	21	
Weight	kg	0.50	0.50	0,50	0.55	0.55	0,55	0,55	
Dimensions (WxHxD)	mm	90x90x86	90x90x86	90x90x86	90x90x86	90x90x86	90x90x86	90x90x86	
<b>Order information</b>	Art. no.	231466	231470	231474	231478	231467	231471	231475	231479

\* Sink type transistor output units on request.

**Base Units with 40–60 I/Os**

Specifications	FX3G-40 MR/ES	FX3G-40 MT/ESS	FX3G-40 MR/DS	FX3G-40 MT/DSS	FX3G-60 MR/ES	FX3G-60 MT/ESS	FX3G-60 MR/DS	FX3G-60 MT/DSS	
Integrated inputs/outputs	40	40	40	40	60	60	60	60	
Power supply	100–240 V AC	100–240 V AC	24 V DC	24 V DC	100–240 V AC	100–240 V AC	24 V DC	24 V DC	
Integrated inputs	24	24	24	24	36	36	36	36	
Integrated outputs	16	16	16	16	24	24	24	24	
Output type	Relay	Transistor (source)*	Relay	Transistor (source)*	Relay	Transistor (source)*	Relay	Transistor (source)*	
Power consumption	W	37	25	25	40	40	29	29	
Weight	kg	0.70	0.70	0,70	0.85	0.85	0,85	0,85	
Dimensions (WxHxD)	mm	130x90x86	130x90x86	130x90x86	175x90x86	175x90x86	175x90x86	175x90x86	
<b>Order information</b>	Art. no.	231468	231472	231476	231480	231469	231473	231477	231481

\* Sink type transistor output units on request.

■ Base Units □ FX1S □ FX1N  FX3G □ FX3U □ FX3UC

### Environmental Specifications

General specifications	Data
Ambient temperature	0–55 °C (storage temperature: -25–+75 °C)
Protection	IP10
Noise durability	1000 Vpp with noise generator; 1 μs at 30–100 Hz
Dielectric withstand voltage	1500 V AC, 1 min.
Ambient relative humidity	5–95 % (non-condensing)
Shock resistance	147m/s <sup>2</sup> Acceleration, Action time: 11ms, 3 times by half-sine pulse in each direction X, Y, and Z
Vibration resistance	Acc. to IEC 68-2-6: 1 g (resistance to vibrations from 57–150 Hz for 80 minutes along all 3 axes); 0.5 g for DIN rail mounting
Insulation resistance	500 V DC, 5 MΩ
Ground	Class D: Grounding resistance 100 Ω or less
Fuse	For FX3G-14M□ and FX3G-24M□: 250 V 1 A; For FX3G-40M□ and FX3G-60M□: 250 V 3.15 A
Environment	Avoid environments containing corrosive gases, install in a dust-free location.
Certifications	Please refer to pages 66–67 in this catalogue

### Electrical Specifications

Power supply specifications	AC powered modules (FX-3G-□M□/ES/ESS)
Power supply	100–240 V AC (+10 %/-15 %), 50/60 Hz
Inrush current at ON	30 A/<5 ms (at 100 V AC); 50 A/<5 ms (at 200 V AC)
Allowable momentary power failure time	10 ms
Primary power supply	—
External power supply (24 V DC)	400 mA

Output specifications	Relay modules	Transistor modules
Switching voltage (max.)	V	<240 V AC, <30 V DC
Max. output current	- per output	A
	- per group*	A
Max. switching current	- inductive load	80 VA
Response time	ms	10
Life of contacts (switching times) ②		<0.2 (<5 μs for Y0, Y1) ①
		3,000,000 at 20 VA; 1,000,000 at 35 VA; 200,000 at 80 VA

① The 40 and 60 I/O points main units supports 5 μs for Y2. ② Not guaranteed by Mitsubishi Electric.  
\* This limitation applies only per reference terminal for each group, 4 and 8 outputs for relays and 2 and 4 outputs for transistors. Please observe the terminal assignments for the group identification.

### Programming Specifications

System specifications	FX3G
<b>Program data</b>	
I/O points (addresses)	256 total (combined local and CC-Link remote I/O)
Address range	Max. 128 direct addressing and max. 128 remote I/O
Program memory	32,000 steps EEPROM (internal), exchangeable EEPROM memory cassette
Cycle period	0.21 μs or 0.42 μs/contact instruction
Number of instructions	29 sequence instructions, 2 step ladder instructions, 123 applied instructions
Programming language	Step ladder, instruction list, SFC
Program execution	Cyclical execution, refresh mode processing
Program protection	2 different keywords, maximum password length 16 characters

System specifications	FX3G
<b>Operands</b>	
Internal relays	7680
Special relays	512
Step ladder	4096
Timer	320
Ext. preset value via potentiometer	2
Counter	235
High-speed counter	6 single phase inputs (max. 60 kHz), 3 double phase inputs (max. 30 kHz)
Real-time clock	Year, month, day, hour, minute, second, weekday
Data register	8,000
File register	24,000 (E0~R23999) internal/optional memory
Index register	16
Special register	512 (D8000-D8511)
Pointer	2,048
Nestings	8
Interrupt inputs	6
Constants	16 bits: K: -32,768 to +32,767; hex: 0–FFFF 32 bits: K: 2,147,483,648 to +2,147,483,647; hex: 0–FFFF FFFF

The MELSEC FX3U Series

2  
FX BASE UNITS

RAM/EEPROM memory for up to **64,000 PLC program steps** gives you plenty of reserve, even for big, complex applications.

**Integrated high-speed counter** inputs for processing fast input signals. For example, you can configure six 100 kHz counters and two 10 kHz counters.

**Interrupt processing** is also handled via the inputs.

Add-in function boards can be installed in the PLC to provide a **second RS485 / RS422 / RS232/USB communications interface** for programming or network configurations.

The base units can be expanded to provide configurations with up to 384 inputs and outputs with **compact extension units** (total of 384 only by using main unit I/Os, extension unit I/Os and remote I/Os).

An **integrated RUN/STOP switch** is available.

**Integrated real-time clock** with year, month, days and time

Connection possibility for special function adapter modules

Three **integrated pulse outputs** for frequencies up to 100 kHz with **deceleration and acceleration ramps** for controlling stepping motors and outputting **pulse-width modulated signals**.

**Integrated serial interface** for direct communication with computers

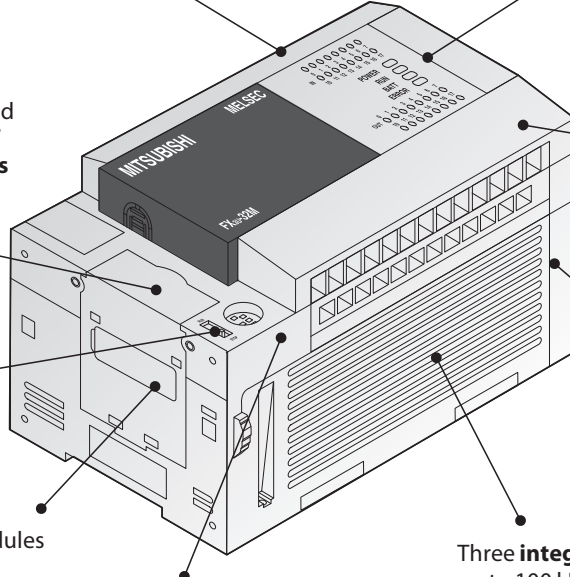

Description of the Unit Components

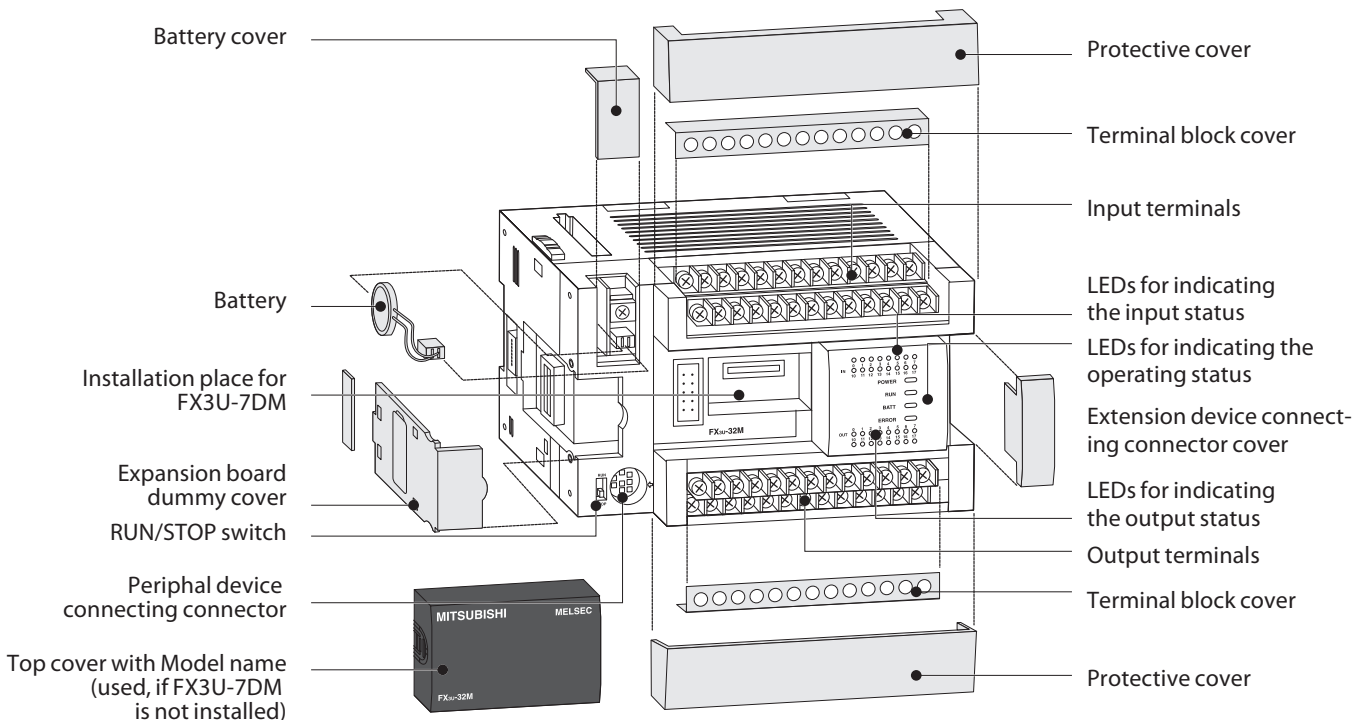



■ Base Units

FX1S  FX1N  FX3G  FX3U  FX3UC

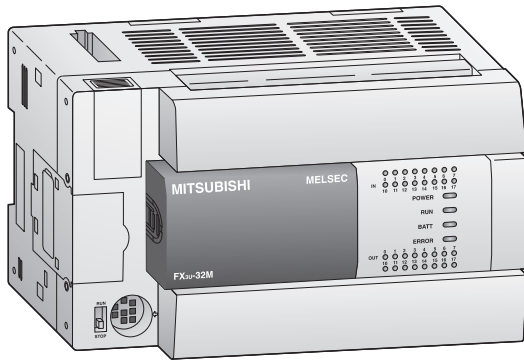

**Base Units FX3u**

The FX3U series base units are available with 16, 32, 48, 64, 80 or 128 input/output points expandable to 384 points.

It is possible to choose between relay and transistor output type.

*Note: Additional special versions are available on request.*

**Special Features:**

- Integrated serial interface for communication between PCs and HMI
- Integrated positioning control
- Exchangeable interface modules for direct mounting into a base unit
- LEDs for indicating the input and output status
- Slot for memory cassettes
- Integrated real-time clock
- Expandable with digital I/O modules, special function modules and ADP modules
- User-friendly programming systems, including IEC 1131.3 (EN 61131.3) compatible programming software, HMIs and hand-held programming units

2

FXBASE UNITS

**Base Units with 16 I/Os**

Specifications	FX3U-16 MR/DS	FX3U-16 MR/ES	FX3U-16 MT/DSS	FX3U-16 MT/ESS
Integrated inputs/outputs	16	16	16	16
Power supply	24 V DC	100–240 V AC	24 V DC	100–240 V AC
Integrated inputs	8	8	8	8
Integrated outputs	8	8	8	8
Output type	Relay	Relay	Transistor (source type)	Transistor (source type)
Power consumption	25 W	30 VA	25 W	30 VA
Weight	kg 0.6	0.6	0.6	0.6
Dimensions (WxHxD)	mm 130x90x86	130x90x86	130x90x86	130x90x86
<b>Order information</b>	Art. no. 231498	231486	231503	231492

**Base Units with 32 I/Os**

Specifications	FX3U-32 MR/DS	FX3U-32 MR/ES	FX3U-32 MT/DSS	FX3U-32 MT/ESS
Integrated inputs/outputs	32	32	32	32
Power supply	24 V DC	100–240 V AC	24 V DC	100–240 V AC
Integrated inputs	16	16	16	16
Integrated outputs	16	16	16	16
Output type	Relay	Relay	Transistor (source type)	Transistor (source type)
Power consumption	30 W	35 VA	30 W	35 VA
Weight	kg 0.65	0.65	0.65	0.65
Dimensions (WxHxD)	mm 150x90x86	150x90x86	150x90x86	150x90x86
<b>Order information</b>	Art. no. 231499	231487	231504	231493

## Base Units with 48 I/Os

Specifications	FX3U-48 MR/DS	FX3U-48 MR/ES	FX3U-48 MT/ESS	FX3U-48 MT/DSS
Integrated inputs/outputs	48	48	48	48
Power supply	24 V DC	100–240 V AC	100–240 V AC	24 V DC
Integrated inputs	24	24	24	24
Integrated outputs	24	24	24	24
Output type	Relay	Relay	Transistor (source type)	Transistor (source type)
Power consumption	35 W	40 VA	40 VA	35 W
Weight	kg 0.85	0.85	0.85	0.85
Dimensions (WxHxD)	mm 182x90x86	182x90x86	182x90x86	182x90x86
<b>Order information</b>	Art. no. 231500	231488	231494	231505

## Base Units with 64 I/Os

Specifications	FX3U-64 MR/DS	FX3U-64 MR/ES	FX3U-64 MT/ESS	FX3U-64 MT/DSS
Integrated inputs/outputs	64	64	64	64
Power supply	24 V DC	100–240 V AC	100–240 V AC	24 V DC
Integrated inputs	32	32	32	32
Integrated outputs	32	32	32	32
Output type	Relay	Relay	Transistor (source type)	Transistor (source type)
Power consumption	40 W	45 VA	45 VA	40 W
Weight	kg 1.0	1.0	1.0	1.0
Dimensions (WxHxD)	mm 220x90x86	220x90x86	220x90x86	220x90x86
<b>Order information</b>	Art. no. 231501	231489	231495	231506

## Base Units with 80–128 I/Os

Specifications	FX3U-80 MR/DS	FX3U-80 MR/ES	FX3U-80 MT/DSS	FX3U-80 MT/ESS	FX3U-128 MR/ES	FX3U-128 MT/ESS
Integrated inputs/outputs	80	80	80	80	128	128
Power supply	24 V DC	100–240 V AC	24 V DC	100–240 V AC	100–240 V AC	100–240 V AC
Integrated inputs	40	40	40	40	64	64
Integrated outputs	40	40	40	40	64	64
Output type	Relay	Relay	Transistor (source type)	Transistor (source type)	Relay	Transistor (source type)
Power consumption	45 W	50 VA	45 W	50 VA	65 VA	65 VA
Weight	kg 1.20	1.20	1.20	1.20	1.80	1.80
Dimensions (WxHxD)	mm 285x90x86	285x90x86	285x90x86	285x90x86	350x90x86	350x90x86
<b>Order information</b>	Art. no. 231502	231490	231507	231496	231491	231497

■ Base Units □ FX1S □ FX1N □ FX3G  FX3U □ FX3UC

### Environmental Specifications

General specifications	Data
Ambient temperature	0–55 °C (storage temperature: -25–+75 °C)
Protection	IP10
Noise durability	1000 Vpp with noise generator; 1 μs at 30–100 Hz
Dielectric withstand voltage	AC PSU: 1500 V AC, 1 min./DC PSU: 500 V AC, 1 min.
Ambient relative humidity	5–95 % (non-condensing)
Shock resistance	Acc. to IEC 68-2-27: 15G (3 times each in 3 directions for 11 ms)
Vibration resistance	Acc. to IEC 68-2-6: 1G (resistance to vibrations from 57–150 Hz for 80 minutes along all 3 axes); 0.5G for DIN rail mounting
Insulation resistance	500 V DC, 5 MΩ
Ground	Class D: Grounding resistance 100 Ω or less
Fuse	From FX3U-16M□ to FX3U-32M□: 3.15 A; From FX3U-48M□ to FX3U-128M□: 5 A
Environment	Avoid environments containing corrosive gases, install in a dust-free location.
Certifications	Please refer to pages 66–67 in this catalogue

### Electrical Specifications

Power supply specifications	DC powered modules (FX3U-□M□/DS/DSS)	AC powered modules (FX3U-□MR/ES)
Power supply	24 V DC (+20 %/-30 %)	100–240 V AC (+10 %/-15 %), 50/60 Hz
Inrush current at ON	—	30 A / <5 ms (at 100 V AC); 65 A / <5 ms (at 200 V AC)
Allowable momentary power failure time	5 ms	10 ms
Primary power supply	24 V DC	—
External power supply (24 V DC)	—	FX3U-16/32MR/ES: 400 mA / FX3U-48–128MR/ES: 600 mA

Output specifications	Relay modules	Transistor modules
Switching voltage (max.)	V <240 V AC, <30 V DC	5–30 V DC
Max. output current	- per output: A 2 - per group*: A 8	0.5 / 0.3 <sup>①</sup> 0.8/1.6 <sup>②</sup>
Max. switching current	- inductive load: 80 VA	12 W/7.2 W
Response time	ms 10	<0.2(Y0,Y1<30 μs)
Life of contacts (switching times) <sup>③</sup>	3,000,000 at 20 VA; 1,000,000 at 35 VA; 200,000 at 80 VA	

① for Y0 and Y1 = 0.3 A; all others 0.5 A    ② 0.8 for 4 per group and 1.6 for 8 per group  
 ③ Not guaranteed by Mitsubishi Electric.  
 \* This limitation applies only per reference terminal for each group, 4 and 8 outputs for relays and 2 and 4 outputs for transistors. Please observe the terminal assignments for the group identification.

### Programming Specifications

System specifications	FX3U
<b>Program data</b>	
I/O points (addresses)	Max. total 384 (with remote I/O)
Address range	Max. 256 direct addressing and max. 256 network I/Os
Program memory	64,000 steps RAM (internal), exchangeable FLROM for easy program exchange
Cycle period	0.065 μs /basic instruction
Number of instructions	27 sequence instructions, 2 step ladder instructions, 209 applied instructions
Programming language	Step ladder, instruction list, SFC
Program execution	Cyclical execution, refresh mode processing
Program protection	Password protection with 3 protection levels*

\* Protection levels may only be changed with FX-10P/FX-20P/FX-30P.

System specifications	FX3U
<b>Operands</b>	
Internal relays	7,680
Special relays	512
State relays	4,096
Timer	512
Counter	235
High-speed counter	16
High-speed counter speed	1 phase, 8 points max: 100kHz/6 points 10kHz/2 points 2 phase, 2 points max: 50kHz/2 points
Real-time clock	Year, month, day, hour, minute, second, weekday
Data register	8,000
Extension file register	32768
Index register	16
Special register	512
Pointer	4,096
Nestings	8
Interrupt inputs	6
Constants	16 bits: K: -32768 to +32768, hex: 0–FFFF; 32 bits: K: -2147483648 to +2147483647; hex: 0–FFFF FFFF

The MELSEC FX3UC Series

2  
FX BASE UNITS

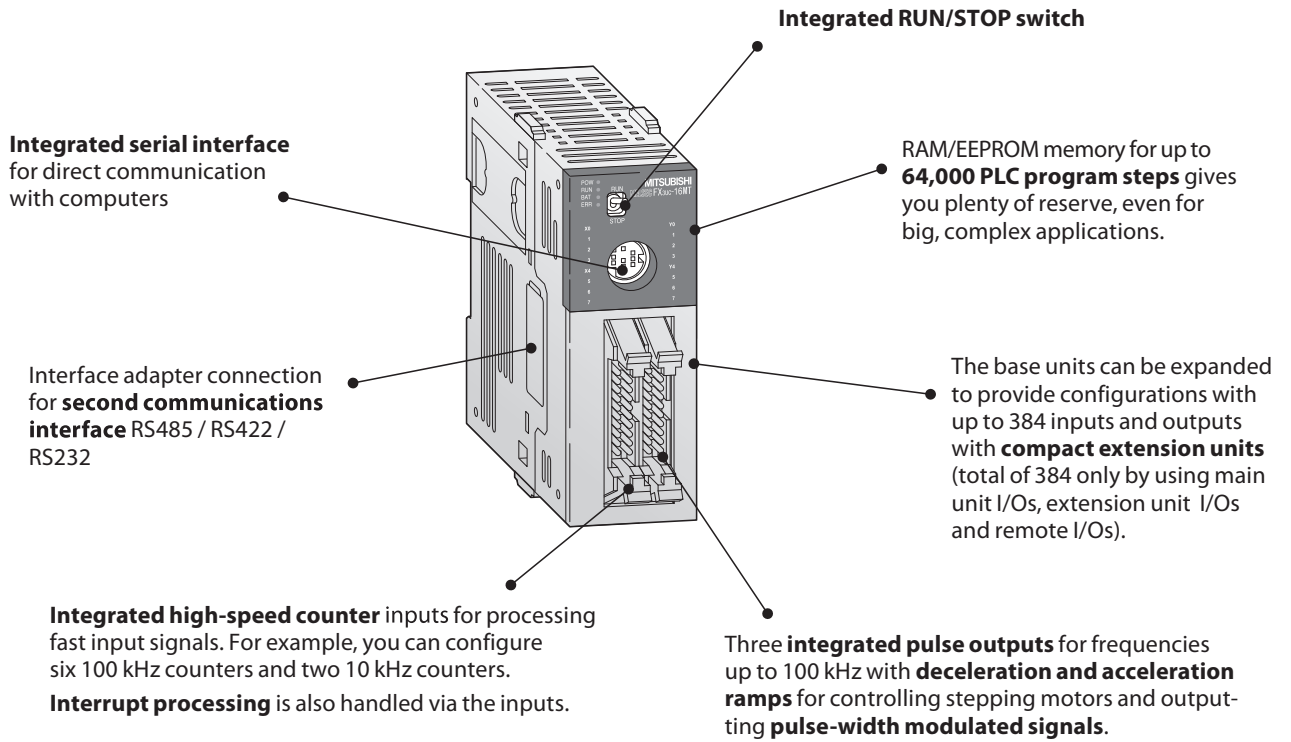

Description of the Unit Components

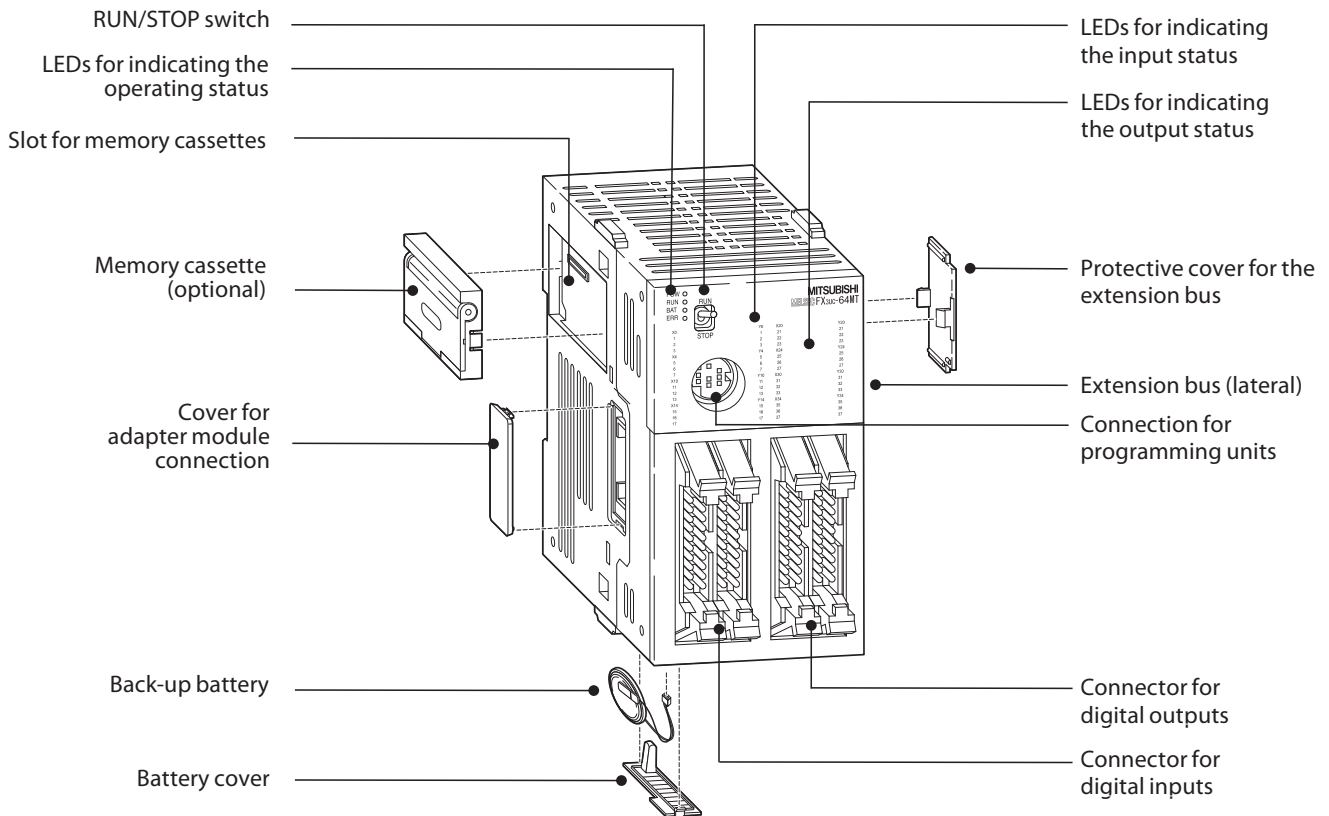

■ Base Units

□ FX1S □ FX1N □ FX3G □ FX3U  FX3UC

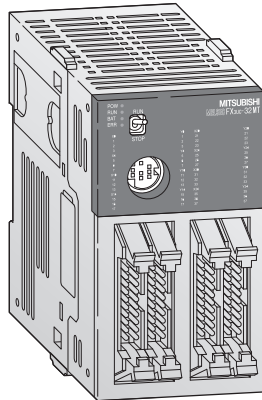

**Base Units FX3uc**

The FX3U series base units are available with 16, 32, 64 or 128 input/output points (expandable to 384 I/Os). It is possible to choose between relay and transistor output type.

**Special Features:**

- Integrated serial interface for communication between PCs and HMI
- Same instruction set as FX3U
- Integrated positioning control
- Very compact dimensions
- LEDs for indicating the input and output status
- Slot for memory cassette
- Adapter modules and system cabling sets available for units with ribbon cable connectors
- Expandable with digital I/O modules, special function modules and ADP modules
- User-friendly programming systems, including IEC 1131.3 (EN 61131.3) compatible programming software, HMIs and hand-held programming units

2

FXBASE UNITS

**Base Units with 16–96 I/Os**

Specifications	FX3UC-16 MT/DSS	FX3UC-32 MT/DSS	FX3UC-64 MT/DSS	FX3UC-96 MT/DSS
Integrated inputs/outputs	16	32	64	96
Power supply	24 V DC (+20 %, -15 %)	24 V DC (+20 %, -15 %)	24 V DC (+20 %, -15 %)	24 V DC (+20 %, -15 %)
Integrated inputs	8	16	32	48
Integrated outputs	8	16	32	48
Output type	Transistor (source type)*	Transistor (source type)*	Transistor (source type)*	Transistor (source type)*
Power consumption	W 6	8	11	14
Weight	kg 0.2	0.2	0.3	0.35
Dimensions (WxHxD)	mm 34x90x74	34x90x74	59.7x90x74	85.4x90x74
<b>Order information</b>	Art. no. 231508	231509	231510	231511

\* Sink type transistor output units on request.

**System Cabling**

A choice of terminal blocks with screw or spring terminals are available for easy wiring of the FX3UC modules with standard ribbon cable connectors.

For more details please refer to the "Accessories" section in this catalogue.

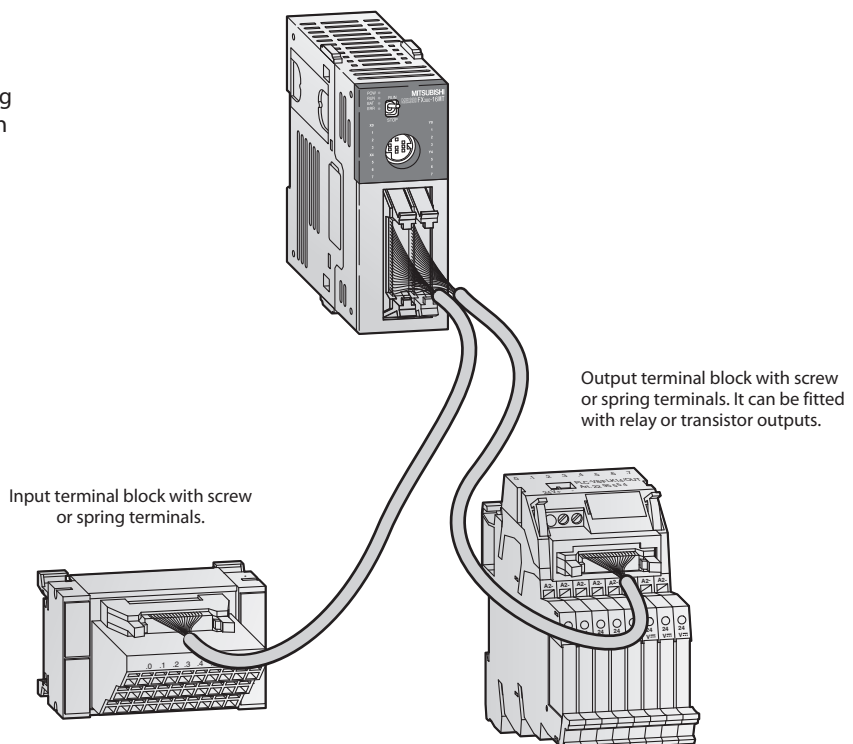

■ Base Units □ FX1S □ FX1N □ FX3G □ FX3U ☑ FX3UC

## Environmental Specifications

General specifications	Data
Ambient temperature	0–55 °C (storage temperature: –25–+75 °C)
Protection	IP10
Noise durability	1000 Vpp with noise generator; 1 μs at 30–100 Hz
Dielectric withstand voltage	AC PSU: 1500 V AC, 1 min./DC PSU: 500 V AC, 1 min.
Ambient relative humidity	5–95 % (non-condensing)
Shock resistance	Acc. to IEC 68-2-27: 15G (3 times each in 3 directions for 11 ms)
Vibration resistance	Acc. to IEC 68-2-6: 1G (resistance to vibrations from 57–150 Hz for 80 minutes along all 3 axes); 0.5G for DIN rail mounting
Insulation resistance	500 V DC, 5 MW
Ground	Class D: Grounding resistance 100 W or less
Environment	Avoid environments containing corrosive gases, install in a dust-free location.
Certifications	Please refer to pages 66–67 in this catalogue

## Electrical Specifications

Power supply specifications	All modules
Power supply	24 V DC (+20 %/–30 %)
Inrush current at ON	—
Allowable momentary power failure time	5 ms
Primary power supply	24 V DC
External power supply (24 V DC)	—

Output specifications	All modules
Switching voltage (max.)	V 5–30 V DC
Max. output current	- per output A 0.1/0.3 <sup>①</sup>
	- per group* A 0.8/1.6
Max. switching current	- inductive load 2.4 W/7.2 W <sup>②</sup>
Response time	ms <0.2 (Y0, Y1 <30 μs)
Life of contacts (switching times) <sup>③ ③</sup>	3,000,000 at 20 VA; 1,000,000 at 35 VA; 200,000 at 80 VA

① for Y0 and Y1 = 0.3 A; all others 0.1 A    ② 7.2 W for Y0 to Y3, all other outputs 2.4 W  
 ③ Not guaranteed by Mitsubishi Electric.  
 \* This limitation applies only per reference terminal for each group, 4 and 8 outputs for relays and 2 and 4 outputs for transistors. Please observe the terminal assignments for the group identification.

## Programming Specifications

System specifications	FX3UC
<b>Program data</b>	
I/O points (addresses)	Max. total 384 (with remote I/O)
Address range	Max. 256 direct addressing and max. 256 network I/Os
Program memory	64,000 steps RAM (internal), exchangeable FLROM for easy program exchange
Cycle period	0.065 μs/basic instruction
Number of instructions	27 sequence instructions, 2 step ladder instructions, 209 applied instructions
Programming language	Step ladder, instruction list, SFC
Program execution	Cyclical execution, refresh mode processing
Program protection	Password protection with 3 protection levels*

\* Protection levels may only be changed with FX-30P.

System specifications	FX3UC
<b>Operands</b>	
Internal relays	7,680
Special relays	512
State relays	4,096
Timer	512
Counter	235
High-speed counter	16
High-speed counter speed	1 phase, 8 points max: 100 kHz/6 points 10 kHz/2 points 2 phase, 2 points max: 50 kHz/2 points
Real-time clock	Year, month, day, hour, minute, second, weekday
Data register	8,000
Extension file register	32768
Index register	16
Special register	512
Pointer	4,096
Nestings	8
Interrupt inputs	6
Constants	16 bits: K: –32768 to +32768, hex: 0–FFFF; 32 bits: K: –2147483648 to +2147483647; hex: 0–FFFF FFFF

■ Powered Compact Extension Units

FX1S  FX1N  FX3G  FX3U  FX3UC

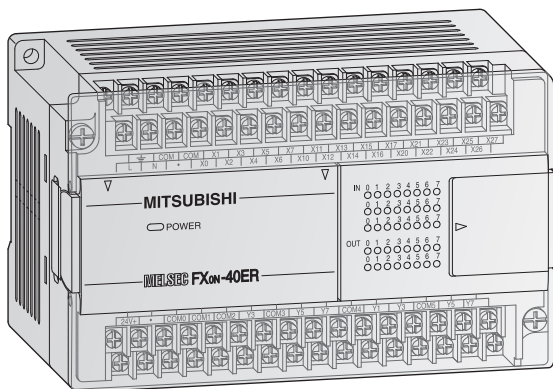

**Extension Units FX0N**

The FX0N series extension units are available with 40 input/output points.

It is possible to choose between relay and transistor output type.

**Special Features:**

- LEDs for indicating the input and output status
- MELSEC FX1N series compatible
- Integrated service power supply with up to 200 mA capacity

Specifications	FX0N-40 ER-ES/UL	FX0N-40 ER-DS	FX0N-40 ET-DSS
<b>Electrical data</b>			
Integrated inputs/outputs	40	40	40
Power supply	AC range (+10 %, -15 %)	100–240 V	—
	Frequency at AC Hz	50/60	—
	DC range (+20 %, -15 %)	—	24 V
Max. input apparent power	40 VA	20 W	30 W
Inrush current at ON	100 V AC	30 A/5 ms	—
	200 V AC	50 A/5 ms	—
	24 V DC	—	60 A/50 μs
Allowable momentary power failure time	ms	10	5
External service power supply (24 V DC)	mA	200	—
<b>Inputs</b>			
Integrated inputs	24	24	24
Min. current for logical 1	mA	3.5	3.5
Max. current for logical 0	mA	1.5	1.5
Response time	For all extension units of the MELSEC FX0N series: 10 ms (at time of shipment)		
<b>Outputs</b>			
Integrated outputs	16	16	16
Output type	Relay	Relay	Transistor
Max. switching voltage	Generally for relay version: <240 V AC, <30 V DC; for transistor version: 5–30 V DC		
Max. output current	- per output	A	2
	- per group*	A	5
Max. switching power - inductive load	VA	80	12
Response time	ms	10	<0.2
Life of contacts (switching times) ②	For all extension units of the MELSEC FX0N series: 3,000,000 at 20 VA; 1,000,000 at 35 VA; 200,000 at 80 VA (only for relay output)		
<b>Mechanical data</b>			
Weight	kg	0.75	0.75
Dimensions (WxHxD)	mm	150x90x87	150x90x87
<b>Order information</b>	Art. no.	60012	55955
			55954

① 0.8 for 4 per group

② Not guaranteed by Mitsubishi Electric.

\* This limitation applies only per reference terminal for each group. Please observe the terminal assignments for the group identification.

## ■ Powered Compact Extension Units

□ FX1S □ FX1N □ FX3G □ FX3U □ FX3UC

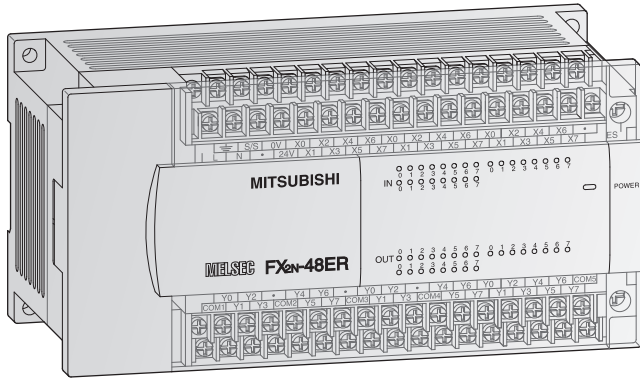

### Extension Units FX2N

The FX2N series extension units are available with 32 or 48 input/output points.

It is possible to choose between relay and transistor output type.

### Special Features:

- LEDs for indicating the input and output status
- MELSEC FX1N/FX3G and FX3U series compatible
- Detachable terminal blocks
- Integrated service power supply with 250 mA or 460 mA

Specifications	FX2N-32 ER-ES/UL	FX2N-32 ET-ESS/UL	FX2N-48 ER-DS	FX2N-48 ER-ES/UL	FX2N-48 ET-DSS	FX2N-48 ET-ESS/UL
<b>Electrical data</b>						
Integrated inputs/outputs	32	32	48	48	48	48
Power supply	AC range (+10%, -15%)	100–240 V	—	100–240 V	—	100–240 V
	frequency at AC	50/60	—	50/60	—	50/60
	DC range (+20%, -30%)	—	24 V	—	24 V	—
Max. input apparent power	35 VA	35 VA	30 W	45 VA	30 W	45 VA
Inrush current at ON	100 V AC	40 A <5 ms	—	40 A <5 ms	40 A <5 ms	40 A <5 ms
	200 V AC	60 A <5 ms	—	60 A <5 ms	60 A <5 ms	60 A <5 ms
Allowable momentary power failure time	ms	10	5	10	5	10
External service power supply (24 V DC)	mA	250	—	460	—	460
Power supply int. bus (5 V DC)	mA	690	690	690	690	690
<b>Inputs</b>						
Integrated inputs	16	16	24	24	24	24
Min. current for logical 1	mA	3.5	3.5	3.5	3.5	3.5
Max. current for logical 0	mA	1.5	1.5	1.5	1.5	1.5
Response time	For all extension units of the MELSEC FX2N series: 10 ms (at time of shipment)					
<b>Outputs</b>						
Integrated outputs	16	16	24	24	24	24
Output type	Relay	Transistor (source)	Relay	Relay	Transistor (source)	Transistor (source)
Switching voltage (max.)	Generally for relay version: <264 V AC, <30 V DC; for transistor version: 5–30 V DC					
Max. output current	- per output	A	2	2	0.5	0.5
	- per group*	A	8	8	0.8/1.6 <sup>②</sup>	0.8/1.6 <sup>②</sup>
Max. switching power - inductive load	W	80	12	80	12	12
Response time	ms	10	<0.2	10	<0.2	<0.2
Life of contacts (switching times) <sup>①</sup>	For all extension units of the MELSEC FX2N series: 3,000,000 at 20 VA; 1,000,000 at 35 VA; 200,000 at 80 VA (for relay output only)					
<b>Mechanical data</b>						
Weight	kg	0.65	0.65	0.85	0.85	0.85
Dimensions (WxHxD)	mm	150x90x87	150x90x87	182x90x87	182x90x87	182x90x87
<b>Order information</b>	Art. no.	65568	65569	66633	65571	66634
		65572				

<sup>①</sup> Not guaranteed by Mitsubishi Electric    <sup>②</sup> 0.8 for 4 per group and 1.6 for 8 per group

\* This limitation applies only per reference terminal for each group. Please observe the terminal assignments for the group identification.



■ Unpowered Modular Extension Blocks

□ FX1S ✓ FX1N ✓ FX3G ✓ FX3U ✓ FX3UC

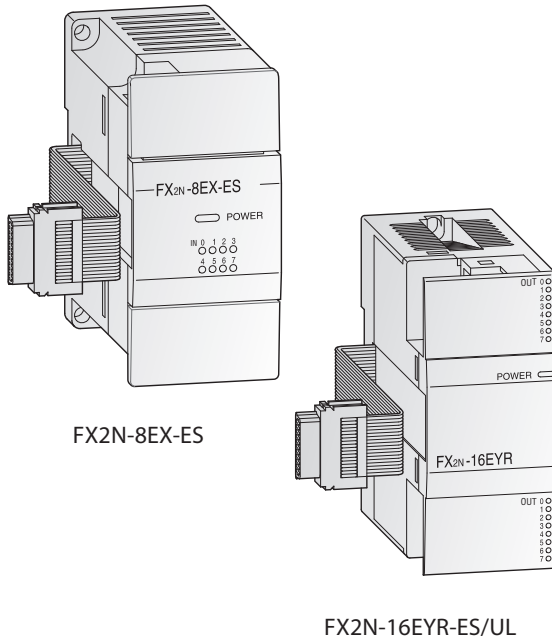

**Extension Blocks FX2N**

The FX2N series modular extension blocks are available with 8 or 16 input/output points. It is possible to choose between relay and transistor output type.

**Special Features:**

- LEDs for indicating the input and output status
- MELSEC FX1N/FX3G and FX3U series compatible
- Very compact dimensions
- Vertically terminal blocks with a cable guide to the upper or lower side

Specifications	FX2N-8 ER-ES/UL	FX2N-8 EX-ES/UL	FX2N-8 EYR-ES/UL	FX2N-8 EYT-ESS/UL	FX2N-16 EX-ES/UL	FX2N-16 EYR-ES/UL	FX2N-16 EYT-ESS/UL
<b>Electrical data</b>							
Integrated inputs/outputs	8	8	8	8	16	16	16
Nbr. of occupied I/O points in the PLC	16	8	8	8	16	16	16
Power supply	All modular extension blocks are supplied by the base unit.						
<b>Inputs</b>							
Integrated inputs	4	8	—	—	16	—	—
Min. current for logical 1	mA	3.5	—	—	3.5	—	—
Max. current for logical 0	mA	1.5	—	—	1.5	—	—
Response time	For all extension blocks of the MELSEC FX2N series: 10 ms (at time of shipment)						
<b>Outputs</b>							
Integrated outputs	4	—	8	8	—	16	16
Output type	Relay	—	Relay	Transistor	—	Relay	Transistor (source)
Max. switching voltage	Generally for relay version: <240 V AC, <30 V DC; for transistor version: 5–30 V DC						
Max. output current	A	2	—	2	0.5	—	2
- per output	A	8	—	8	0.8	—	8
- per group <sup>①</sup>	VA	80	—	80	12	—	80
Max. switching power	ms	10	10	10	<0.2	—	10
Response time	For all extension units of the MELSEC FX2N series: 3,000,000 at 20 VA; 1,000,000 at 35 VA; 200,000 at 80 VA (for relay output only)						
Life of contacts (switching times) <sup>②</sup>							
<b>Mechanical data</b>							
Weight	kg	0.2	0.2	0.2	0.2	0.3	0.3
Dimensions (WxHxD)	mm	43x90x87	43x90x87	43x90x87	43x90x87	40x90x87	40x90x87
<b>Order information</b>							
Art. no.	166285	166284	166286	166287	65776	65580	65581

① This limitation applies only per reference terminal for each group. Please observe the terminal assignments for the group identification.

② Not guaranteed by Mitsubishi Electric

## Modular Extension Units

FX1S  FX1N  FX3G  FX3U  FX3UC

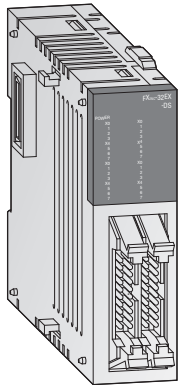

FX2NC-32EX-DS

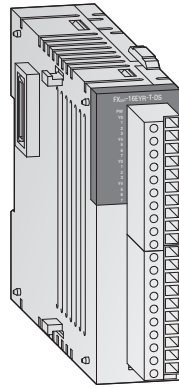

FX2NC-16EYR-DS

### Extension Units FX2NC

The modular extension units of the FX2NC series can be used in combination with FX3UC series base units only. They are available with 16 or 32 input/output points. For modules with 16 outputs it is possible to choose between relay and transistor output type.

*Note: These modules can be used in combination with a FX3UC PLC only!*

#### Special Features:

- Very compact dimensions
- LEDs for indicating the input and output status
- Removable terminal blocks for FX2NC-16EYR-T-DS and FX2NC-16EX-T-DS (interchangeable against optional spring terminal blocks)
- Adapter modules and system cabling sets are optionally available for units with ribbon cable connectors (transistor output types)

Specifications	FX2NC-16 EX-T-DS	FX2NC-16 EYR-T-DS	FX2NC-16 EX-DS	FX2NC-16 EYT-DSS	FX2NC-32 EX-DS	FX2NC-32 EYT-DSS	
<b>Electrical data</b>							
Integrated inputs/outputs	16	16	16	16	32	32	
Power supply	All modular extension blocks are supplied by the base unit.						
<b>Inputs</b>							
Integrated inputs	16	—	16	—	32	—	
Input current X0→X7 / X10→∞	7/5	—	7/5	—	7/5	—	
Min. current for logical 1 X0→X7 / X10→∞	mA 4.5/3.5	—	4.5/3.5	—	4.5/3.5	—	
Max. current for logical 0	mA 1.5	—	1.5	—	1.5	—	
Isolation	Photocoupler isolation between input terminals and PC power for all base units						
Response time	For all extension units of the MELSEC FX2NC series: 10 ms (at time of shipment), partly adjustable between 0 and 60 ms in 1 ms steps (REF, FNCS1 = 0–60 ms)						
<b>Outputs</b>							
Integrated outputs	—	16	—	16	—	32	
Output type	—	Relay	—	Transistor	—	Transistor	
Max. switching voltage	V Generally for relay version: <240 V AC, <30 V DC; for transistor version: 5–30 V DC						
Max. output current	- per output	A —	2	—	0.1/0.3 <sup>①</sup>	—	0.1/0.3 <sup>①</sup>
	- per group*	A —	4/8	—	0.8	—	0.8
Max. switching power	- inductive load	VA —	80	—	2.4/7.2 <sup>②</sup>	—	2.4/7.2 <sup>②</sup>
	- lamp load	W —	100	—	0.3/0.9 <sup>③</sup>	—	0.3/0.9 <sup>③</sup>
Response time	ms —	10	—	<0.2	—	<0.2	
Life of contacts (switching times)	—	like base unit	—	—	—	—	
<b>Mechanical data</b>							
Connection type	Removable screw terminal blocks		Ribbon cable connector	Ribbon cable connector	Ribbon cable connector	Ribbon cable connector	
Weight	kg 0.2	0.2	0.15	0.2	0.2	0.2	
Dimensions (WxHxD)	mm 20.2x90x89	24.2x90x89	14.6x90x87	14.6x90x87	26.2x90x87	26.2x90x87	
<b>Order information</b>	Art. no.	128152	128153	104503	104504	104505	104506

<sup>①</sup> 0.3A for Y0 to Y1; 0.1 A all others    <sup>②</sup> 7.2 W for Y0 to Y3; 2.4 W all others    <sup>③</sup> 0.9 W for Y0 to Y3; 0.3 W all others

\* This limitation applies only per reference terminal for each group. Please observe the terminal assignments for the group identification.

■ Analog Output Modules

□ FX1S  FX1N  FX3G  FX3U  FX3UC

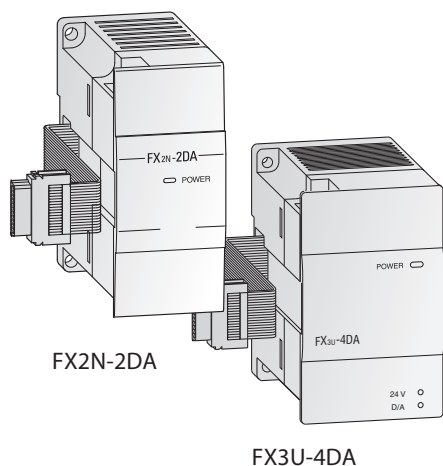

**FX2N-2DA, FX2N-4DA, FX3U-4DA**

The analog output modules provide the user with 2 to 4 analog outputs. The modules convert digital values from the FX1N/FX3G/FX3U controller to the analog signals required by the process. The module can output both current and voltage signals.

*Note: The FX3U-4DA can only be used in combination with a FX3G/FX3U series base unit.*

Specifications		FX2N-2DA	FX2N-4DA	FX3U-4DA
Analog channels	inputs	—	—	—
	outputs	2	4	4
Analog output range	0 → +10 V DC/ 0 → +5 V DC/ 4 → +20 mA	0 → +10 V DC/ 0 → +5 V DC/ 4 → +20 mA	-10 → +10 V DC/ 0 → +20 mA/ 4 → +20 mA	-10 → +10 V DC/ 0 → +20 mA/ 4 → +20 mA
	Resolution	2.5 mV (12 bits)	5 mV (10 bits)	0.32 mV (16 bits + sign)
	current	4 μA (12 bits)	20 μA (11 bits + sign)	0.63 μA (15 bits)
Fullscale overall accuracy	±1 %	±1 %	±1 %	±0.3–0.5 %*
Power supply	5 V DC	30 mA (from base unit)	30 mA (from base unit)	100 mA (from base unit)
	24 V DC	85 mA	200 mA	160 mA
Related I/O points		8	8	8
Weight	kg	0.3	0.3	0.2
Dimensions (WxHxD)	mm	43x90x87	55x90x87	55x90x87
<b>Order information</b>	Art. no.	102868	65586	169509

\* Dependent on the ambient temperature

■ Analog Input Modules

□ FX1S  FX1N  FX3G  FX3U  FX3UC

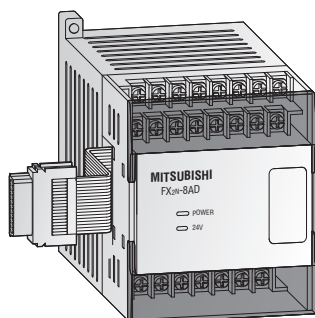
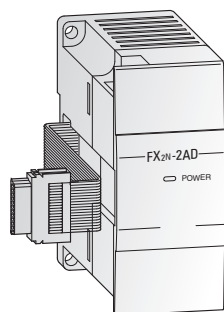

**FX2N-2AD, FX2N-4AD, FX3U-4AD, FX2N-8AD**

The analog input modules provide the user with 2 to 8 analog inputs. The module converts analog process signals into digital values which are further processed by the MELSEC FX1N/FX3G/FX3U controller.

The actual values or mean values over several measurements may be output.

*Note: The FX3U-4AD can only be used in combination with a FX3G/FX3U series base unit.*

Specifications		FX2N-2AD	FX2N-4AD	FX3U-4AD	FX3UC-4AD	FX2N-8AD
Analog channels	inputs	2	4	4	4	8
	outputs	—	—	—	—	—
Analog input range	0 → +10 V DC/ 0 → +5 V DC/ 0/ 4 → +20 mA	0 → +10 V DC/ 0 → +5 V DC/ 0/ 4 → +20 mA	-10 → +10 V DC/ -20 → +20 mA/ 4 → +20 mA	-10 → +10 V DC/ -20 → +20 mA/ 4 → +20 mA	-10 → +10 V DC/ -20 → +20 mA/ 4 → +20 mA	-10 → +10 V DC/ -20 → +20 mA/ 4 → +20 mA
	Resolution	2.5mV, 1.25mV/ 4 μA (12 bits)	5 mV (11 bits + sign)	0.32 mV (16 bits + sign)	0.32 mV (16 bits + sign)	0.63 mV (14 bits + sign)
	current	4 μA (12 bits)	20 μA (10 bits + sign)	1.25 μA (15 bits + sign)	1.25 μA (15 bits + sign)	2.5 μA (13 bits + sign)
Fullscale overall accuracy	±1 %	±1 %	±0.3–1 %*	±0.3–1 %*	±0.3–0.5 %*	
Power supply	5 V DC	20 mA (from base unit)	30 mA (from base unit)	110 mA (from base unit)	100 mA (from base unit)	50 mA (from base unit)
	24 V DC	50 mA (from base unit)	55 mA	90 mA	80 mA	80 mA
Related I/O points		8	8	8	8	8
Weight	kg	0.3	0.3	0.2	0.13	0.4
Dimensions (WxHxD)	mm	43x90x87	55x90x87	55x90x87	20.2x90x79	75x105x75
<b>Order information</b>	Art. no.	102869	65585	169508	210090	129195

\* Dependent on the ambient temperature

Note: The FX2N-8AD can be configured to accept standard analog inputs as well as selected temperature inputs such as K, T or J type thermocouples.

4  
SPECIAL FUNCTION MODULES

■ Combined Analog I/O Modules

□ FX1S □ FX1N □ FX3G □ FX3U □ FX3UC

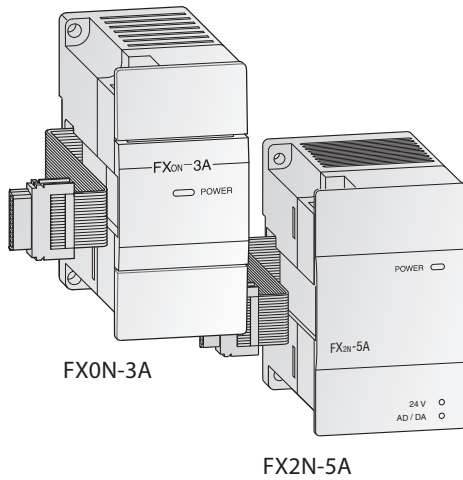

**FX0N-3A, FX2N-5A, FX3U-3A-ADP**

The analog input/output modules are available in two different models. They provide the user with 2 or 4 analog inputs and 1 analog output. They serve for conversion of analog process signals into digital values, and vice versa.

As of the FX2N-5A module the analog inputs can be selected between current or voltage input signals.

*Note: The FX2N-5A may not be used in combination with a FX1N series base unit.*

Specifications		FX0N-3A	FX2N-5A	FX3U-3A-ADP
Number of analog points	inputs	2	4	2
	outputs	1	1	1
Input (resolution)	voltage	0—+10 V (8 bit), 0—+5 V (8 bit)	-10—+10 V (15 bit + sign), -100—+100 mV (11 bit + sign)	0—+10 V (2.5 mV/12 bit)
	current	0/4—+20 mA (8 bit)	-20—+20 mA (14 bit + sign), 0/4—+20 mA (14 bit)	4—+20 mA (5 µA/12 bit)
Output (resolution)	voltage	0—+10 V (8 bit), 0—+5 V (8 bit)	-10—+10 V (12 bit)	0—+10 V (2.5 mV/12 bit)
	current	4—+20 mA (8 bit)	0/4—+20 mA (10 bit)	4—+20 mA (4 µA/12 bit)
Total accuracy		±1 %	±0.3–1 %*	±0.5–1 %*
Power supply	5 V DC	30 mA (from base unit)	70 mA (from base unit)	20 mA (from base unit)
	24 V DC	90 mA (from base unit)	90 mA	90 mA
Related I/O points		8	8	0
Weight	kg	0.2	0.3	0.1
Dimensions (WxHxD)	mm	43x90x87	55x90x87	17.6x90x89.5
<b>Order information</b>		Art. no. 41790	153740	221549

\*Dependent on the ambient temperature

■ Analog Temperature Input Modules

□ FX1S □ FX1N □ FX3G □ FX3U □ FX3UC

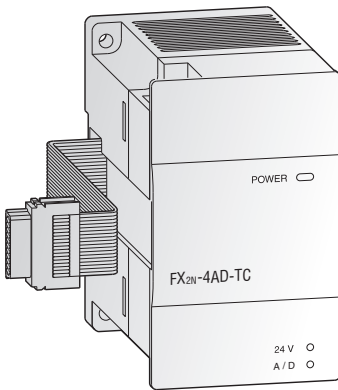

**FX2N-4AD-TC, FX2N-4AD-PT, FX2N-2LC**

The analog input module for thermocouples FX2N-4AD-TC is used for processing temperatures. It has 4 independent inputs for detecting signals from thermocouples of types J and K. The type of thermocouple can be chosen independently for each point.

The analog input module for Pt100 inputs FX2N-4AD-PT permits the connection of four Pt100 sensors to the FX2N/FX3U series controller.

The temperature control module FX2N-2LC is equipped with two temperature input points and two transistor (open collector) output points. It is used to read temperature signals from thermocouples and Pt100 sensors, and performs PID output control

*Note: The FX2N-2LC may not be used in combination with a FX1N series base unit.*

Specifications		FX2N-4AD-TC	FX2N-4AD-PT	FX2N-2LC
Analog inputs		4 (J or K type)	4 (Pt100 sensors)	2 points
Compensated temperature range °C		-100—+600 (J type)/ -100—+1200 (K type)	-100—+600	Thermocouple and Pt100 sensor
Digital outputs		-1000—+6000 (J type)/ -1000—+12000 (K type)	-1,000—6,000 (12 bit conversion)	2 transistor output points
Resolution		0.3 (J type) / 0.4 (K type)	0.2–0.3 °C	0.1 °C or 1 °C
Total accuracy		±0.5 % fullscale +1 °C	±1.0 % fullscale	±0.7 % fullscale (±0.3 % when ambient temperature is 23 °C ±5 °C)
Power supply	5 V DC	40 mA (from base unit)	30 mA (from base unit)	70 mA (from base unit)
	24 V DC	60 mA	50 mA	55 mA
Related I/O points		8	8	8
Weight	kg	0.3	0.3	0.3
Dimensions (WxHxD)	mm	55x90x87	55x90x87	55x90x87
<b>Order information</b>		Art. no. 65588	65587	129196

■ Analog Temperature Input Adapters

FX1S  FX1N  FX3G  FX3U  FX3UC

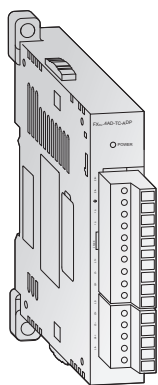

FX3U-4AD-TC-ADP

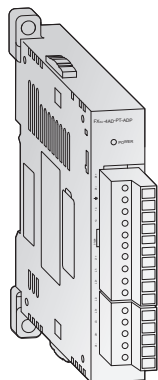

FX3U-4AD-PT-ADP

**FX3U-4AD-TC-ADP, FX3U-4AD-PT-ADP, FX3U-4AD-PTW-ADP, FX3U-4AD-PNK-ADP**

The analog input adapter for thermocouples FX3U-4AD-TC-ADP is used for processing temperatures. It has 4 independent inputs for detecting signals from thermocouples of types J and K.

The FX3U-4AD-PNK-ADP analog input adapter enables the connection of up to four Pt1000/Ni1000 thermocouples.

The FX3U-4AD-PT-ADP and FX3U-4AD-PTW-ADP analog input adapters enable the connection of up to four Pt100 thermocouples to the PLC system.

All analog adapters can be used in combination with the base units of the FX3G/FX3U/FX3UC series only.

*Note: When connecting the analog adapters to a FX3U base unit, a communications adapter is required. A direct connection without adapter is possible if these modules are connected to a FX3UC base unit. When connecting an adapter to a FX3G PLC the communications adapter FX3G-CNV-ADP is required.*

Specifications	FX3U-4AD-TC-ADP	FX3U-4AD-PT-ADP	FX3U-4AD-PTW-ADP	FX3U-4AD-PNK-ADP
Analog inputs	4 (J or K type)	4 (Pt100 sensors)	4 (Pt100 sensors, 3-wire)	(Pt1000/Ni1000 sensors, 2/3 wire)
Compensated temperature range	-100—+600 (J type)/ -100—+1000 (K type)	-50—+250	-100—+600	-50—+250 (Pt1000)/ -40—+110 (Ni1000)
Digital outputs	-1000—+6000 (J type)/ -1000—+10000 (K type)	-500—+2500	-1000—+6000	-500—+2500 (Pt1000)/ -400—+1100 (Ni1000)
Resolution	0.3 (J type)/ 0.4 (K type)	0.1	0.2—0.3	0.1
Total accuracy	±0.5 % fullscale	±0.5—1.0 % fullscale*		
Power supply	5 V DC	15 mA (from base unit)	15 mA (from base unit)	15 mA (from base unit)
	24 V DC	45 mA	50 mA	50 mA
Related I/O points	0	0	0	0
Weight	kg	0.1	0.1	0.1
Dimensions (WxHxD)	mm	17.6x90 (106)x89.5		
<b>Order information</b>	Art. no.	165273	165272	214173
				214172

\*Dependent on the ambient temperature

4  
SPECIAL FUNCTION MODULES

■ Analog I/O Adapters

FX1S  FX1N  FX3G  FX3U  FX3UC

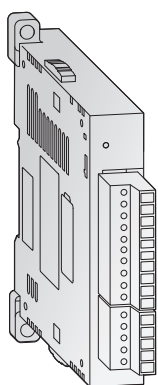

FX3U-4AD-ADP

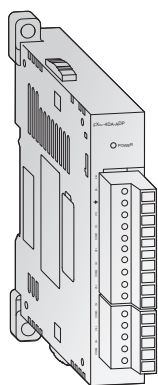

FX3U-4DA-ADP

**FX3U-4AD-ADP, FX3U-4DA-ADP**

The FX3U-4AD-ADP adapter module for analog input is a special function adapter to add four analog input points to the FX3G/FX3U/FX3UC PLC system.

The FX3U-4DA-ADP adapter module for analog output is a special function adapter to add four analog output points to the FX3G/FX3U/FX3UC PLC system.

*Note: When connecting the analog adapters to a FX3U base unit, a communications adapter is required. A direct connection without adapter is possible if these modules are connected to a FX3UC base unit. When connecting an adapter to a FX3G PLC the communications adapter FX3G-CNV-ADP is required.*

Specifications	FX3U-4AD-ADP	FX3U-4DA-ADP	
Analog channels	inputs	4	
	outputs	—	
Analog range	0—+10 V DC, 4—+20 mA	0—+10 V DC, 4—+20 mA	
Resolution	2.5 mV/10 μA (12 bit/11 bit)	2.5 mV/4 μA (12 bit)	
Overall accuracy	±0.5 %*/±1 %	±0.5 %*/±1 %	
Power supply	5 V DC	15 mA (from base unit)	
	24 V DC	40 mA	
Related I/O points	0	150 mA	
Weight	kg	0.1	
Dimensions (WxHxD)	mm	17.6x90 (106)x89.5	
<b>Order information</b>	Art. no.	165241	165271

\*Dependent on the ambient temperature and signal quality

■ Temperature Control Module

FX1S  FX1N  FX3G  FX3U  FX3UC

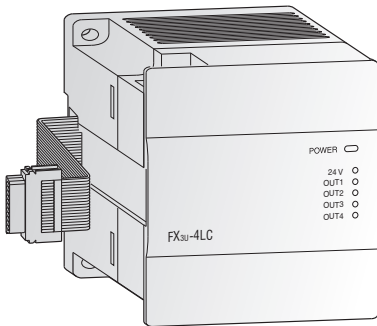

**Temperature control module**

The temperature control module FX3U-4LC is equipped with four temperature input points and four transistor (open collector) output points. It is used to read temperature signals from thermocouples and Pt100 sensors, and performs PID output control.

The proportional band, the integral time and the derivative time can be easily set by auto tuning.

The channels are isolated against each other.

Specifications	FX3U-4LC	
Analog inputs	4 (Thermocouple and Pt100 sensors)	
Compensated temperature range	°C	-200 to +2300
Digital outputs	4 NPN transistor open collector output points	
Resolution	°C	0.1 or 1
Total accuracy	±0.3 to 0.7 % (fullscale, dependent on the ambient temperature)	
Power supply	5 V DC	160 mA (from base unit)
	24 V DC	50 mA
Related I/O points	8	
Dimensions (WxHxD)	mm	90x90x86
<b>Order information</b>	Art. no.	232806

■ Data Logger Module

FX1S  FX1N  FX3G  FX3U  FX3UC

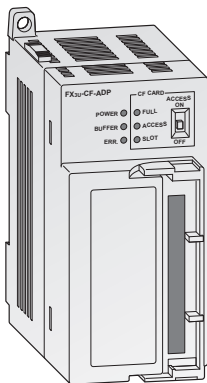

**Data logger module**

The FX3U-CF-ADP is a general purpose data logging adapter. The difference to other available logging units is that the PLC main unit controls the data logging based on user requirements, e.g. periodical or even based. For tracing a timestamp is automatically added to all data storages, that eases alarm and other time critical log-

ging. Another usage is the storage of bigger recipe data. A CompactFlash® memory card up to 2GB can be used. Six applied instructions allow all kinds of data writing, manipulation or reading, making this adapter the optimum solution towards customer requirements.

Specifications	FX3U-CF-ADP	
Data access method	Controlled by the main unit, no polling from the logging unit possible.	
Connectable units	A maximum of one FX3U-CF-ADP can be connected per PLC.	
Time stamp function	The real time clock data of the base unit is used.	
Recommended storage media	CompactFlash® memory card (GT05-MEM-256MC, -512MC, -1GC, -2GC)	
Max. file size	512 MB	
File format	CSV	
Max. numbers of files	63 (Plus one FIFO file.)	
FIFO function	One pattern (The file name gets automatically generated.)	
Power supply	24 V DC	130 mA
Related I/O points	0	
Dimensions (WxHxD)	mm	45x90x89.5
<b>Order information</b>	Art. no.	230104

High-Speed Counter Modules

FX1S  FX1N  FX3G  FX3U  FX3UC

FX2N-1HC, FX2NC-1HC

In addition to the internal high-speed MELSEC FX counters, the high-speed counter modules FX2N-1HC and FX2NC-1HC provide the user with an external counter. It counts 1- or 2-phase pulses up to a frequency of 50 kHz. The counting range covers either 16 or 32 bit. The two integrated transistor outputs can be switched independently of one another by means of internal comparison functions. Hence, simple positioning tasks can also be realized economically. In addition, the FX2N-1HC and FX2NC-1HC can be used as a ring counter.

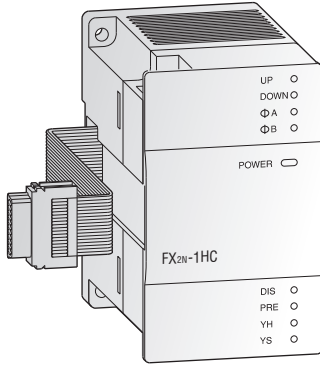

Specifications	FX2N-1HC	FX2NC-1HC
Signal level	5, 12, 24 V DC/7 mA	5, 12, 24 V DC/7 mA
Counter inputs	2 (1 phase) or 1 (2 phase)	2 (1 phase) or 1 (2 phase)
Max. counting frequency	kHz 50	50
Input format	bit 16, 32	16, 32
Type of counter	Up/down counter, ring counter	Up/down counter, ring counter
Counting range	16 bit	0–65535
	32 bit	-2147483648—+2147483647
Output type	2 x transistor (5–24 V DC; 0.5 A)	2 x transistor (5–24 V DC; 0.5 A)
Power supply	5 V DC	90 mA (from base unit)
	24 V DC	—
Related I/O points	8	8
Weight	kg 0.3	0.13
Dimensions (WxHxD)	mm 55x90x87	20.2x90x89
Order information	Art. no. 65584	217916

High-Speed Counter Adapters

FX1S  FX1N  FX3G  FX3U  FX3UC

FX3U-4HSX-ADP, FX3U-2HSY-ADP, FX3U-2HC

These adapter modules allow direct processing of positioning application data. The FX3U-4HSX-ADP and the FX3U-2HC provide high speed counter inputs up to 200 kHz while the FX3U-2HSY-ADP delivers 2 channels of pulse train outputs up to 200 kHz.

*Note: The adapters FX3U-□-ADP can only be used with the FX3U and they require a function extension board.*

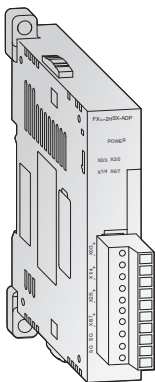

FX3U-4HSX-ADP

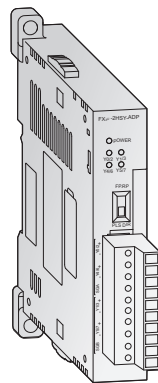

FX3U-2HSY-ADP

Specifications	FX3U-4HSX-ADP	FX3U-2HSY-ADP	FX3U-2HC
Counter	inputs	4	—
	outputs	—	2
Max. counting frequency	inputs	1 ch 1 input or 1 ch 2 inputs: 200 kHz	—
	outputs	2 ch 2 inputs: 100 kHz	200 kHz
Input format	—	Differential line receiver (AM26C32 is suitable) Photocoupler isolation on inputs	Differential line receiver (AM26C32 is suitable) Photocoupler isolation on inputs
	—	Differential line driver (AM26C31 is suitable) Normal rotation pulse train, reverse pulse train or pulse train + one	Transistor output, 5–24 V DC When the counter value coincides with an output compare value, the appropriate output is set ON.
Maximum cable length	m 10	10	10
Input potential	5 V DC	—	5/12/24 V DC
Output load	—	less than 25 mA	0.5 A
Maximum connectivity	2	2	8
Power supply	5 V DC	30 mA (from base unit)	30 mA (from base unit)
	24 V DC	30 mA (from base unit)	60 mA (from base unit)
Related I/O points	0	0	8
Weight	kg 0.08	0.08	0.08
Dimensions (WxHxD)	mm 17.6x90 (106)x89.5	17.6x90 (106)x89.5	55x90x87
Order information	Art. no. 165274	165275	232805

■ Positioning Modules  FX1S  FX1N  FX3G  FX3U  FX3UC

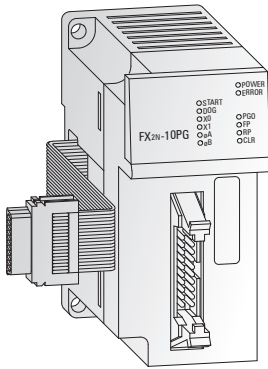

**FX2N-1PG-E, FX2N-10PG**

The positioning modules FX2N-1PG-E and FX2N-10PG are extremely efficient single-axis positioning modules for controlling either step drives or servo drives (by external regulator) with a pulse chain. They are very suitable for achieving accurate positioning in combination with the MELSEC FX series. The configuration and allocation of the position data are carried out directly via the PLC program. A very wide range of manual and automatic functions are available to the user.

Specifications	FX2N-1PG-E	FX2N-10PG
Accessible axes	1	1
Output frequency	pulse/s 10–100 000	1–1 000 000
Signal level for digital inputs	24 V DC/40 mA	5 V DC/100 mA; 24 V DC/70 mA
Power supply	5 V DC 24 V DC	55 mA (from base unit) 120 mA (from base unit)
Related I/O points	8	8
Weight	kg 0.3	0.2
Dimensions (WxHxD)	mm 43x90x87	43x90x87
<b>Order information</b>	Art. no. 65583	140113

■ Positioning Module for SSCNET  FX1S  FX1N  FX3G  FX3U  FX3UC

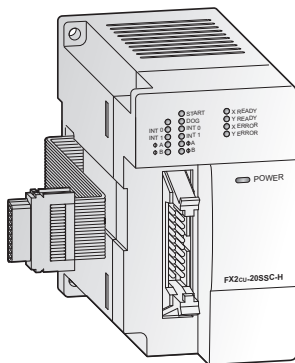

**SSCNET III Module FX3U-20SSC-H**

The SSCNET module FX3U-20SSC-H can be used in combination with a FX3U programmable controller to achieve a cost effective solution for high precision, high speed positioning. The plug-and-play fiber optic SSCNET cabling reduces setup time and increases control distance for positioning operations in a wide range of applications.

Servo parameters and positioning information for the FX3U-20SSC-H are easily set up with an FX3U base unit and a personal computer. For parameter setting, monitoring and testing the easy programming software FX Configurator-FP is available.

*Note: the FX3U-20SSC-H can be used in combination with a FX3U- or FX3UC base unit only. Please refer to the Mitsubishi Electric MELSERVO catalog for suitable servo motors and amplifiers.*

Specifications	FX3U-20SSC-H
Accessible axes	2 (independent or interpolation)
Output frequency	1 Hz to 50 MHz
Pulse output format	SSCNET III (servo bus)
Communications speed	50 Mbps
Starting time	ms 1.6 (+1.7 SSCNET cycle time)
Max. to PLC connectable modules	Up to 8 can be connected to the FX3U PLC
Status displays	Power, module status, axis status, error
Power supply	5 V DC 24 V DC
Related I/O points	8
Weight	kg 0.3
Dimensions (WxHxD)	mm 55x90x87
<b>Order information</b>	Art. no. 168914



■ Network Modules for CC-Link

□ FX1S  FX1N  FX3G  FX3U  FX3UC

**CC-Link Master Module FX2N-16CCL-M**

The CC-Link network enables the controlling and monitoring of decentralized I/O modules at the machine.

The CC-Link master module FX2N-16CCL-M is a special extension block which assigns an FX series PLC as the master station of the CC-Link system.

The setting of all modules within the network is handled directly via the master module.

Up to 15 remote stations and remote device stations can be connected to the master station as decentralized I/O stations. These remote stations can be up to 7 I/O modules and up to 8 remote device stations. 2 master modules can be connected to one FX1N, FX3G or FX3U/FX3UC base unit.

The maximum communications distance is 1200 m without repeater.

*Note: When connecting this module to a FX3UC base unit, the communications adapter FX2N-CNV-IF resp. a power supply unit FX3UC-1PS-5V is required. For more informations about CC-Link please refer to the "Automation Book".*

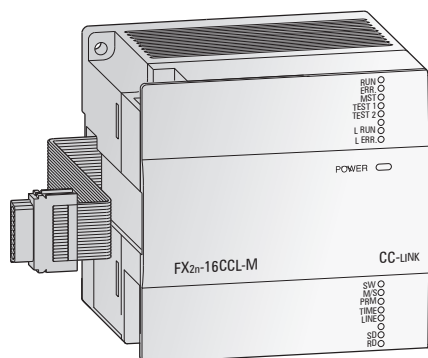

Specifications		FX2N-16CCL-M
Module type		Master station
Link points per station	I/O points	32
	register	8
Max. number of I/O points		128 (with FX1N PLC), 256 (with FX3G PLC)*, 384 (with FX3U PLC)*
Number of connectable modules		Max. 15
Power supply	5 V DC	—
	24 V DC	150 mA
Related I/O points		8
Weight		0.4
Dimensions (WxHxD)		85x90x87
<b>Order information</b>		Art. no. 133596

\*Including I/O points in PLC and network.

**FX3U-64CCL Interface Block**

The FX3U-64CCL CC-Link interface block is available for FX3 series main units and enables CC-Link V2 functionality, for example expanded cyclic transmission which facilitates handling of multiple data processes.

*Note: When attaching the FX3U-64CCL to an FX3UC main unit, the FX2NC-CNV-IF interface converter or the FX3UC-1PS-5V power supply unit is required. For more informations about CC-Link please refer to the "Automation Book".*

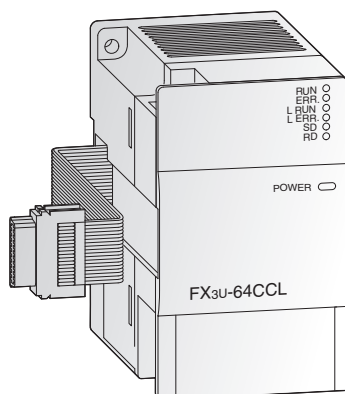

Specifications		FX3U-64CCL
Module type		Intelligent device station
Link points per station	I/O points	128 (Occupying 1 station with Octuple expanded cyclic setting)
	register	32 (Occupying 1 station with Octuple expanded cyclic setting)
Max. transmission speed		10 Mbps
Related I/O points		8
Power supply		24 V DC/220 mA
Weight		0.3
Dimensions (WxHxD)		55x90x87
<b>Order information</b>		Art. no. 217915

■ Network Modules for CC-Link

FX1S  FX1N  FX3G  FX3U  FX3UC

**CC-Link Communication Module FX2N-32CCL**

The communication module FX2N-32CCL enables the user to connect to the CC-Link network with a superior PLC system as master CPU. This gives him access to the network of all MELSEC PLC systems and frequency inverters and to additional products from other suppliers.

Thus the network is expandable via the digital inputs/outputs of the FX modules to a maximum of 256 I/Os.

The buffer memory of the FX2N-32CCL is read and written by FROM/TO instructions.

The connection is to the extension bus on the right side of the controller.

*Note: For more informations about CC-Link please refer to the "Automation Book".*

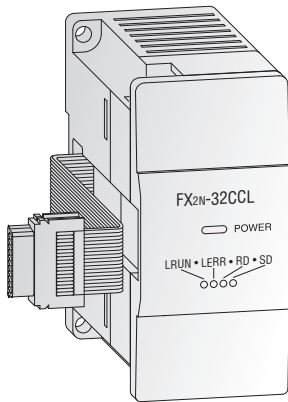

Specifications	FX2N-32CCL	
Module type	Remote station	
Link points per station	I/O points	32
	register	8
Max. number of I/O points	—	
Number of connectable modules	—	
Power supply	5 V DC	max. 130 mA (from base unit)
	24 V DC	50 mA
Related I/O points	8	
Weight	0.3	
Dimensions (WxHxD)	43x90x87	
<b>Order information</b>	Art. no.	102961

■ Network Module for AS-Interface

FX1S  FX1N  FX3G  FX3U  FX3UC

**AS-Interface Module FX2N-32ASI-M**

The FX2N-32ASI-M serves as master module for the connection of the FX1N, FX3G, FX3U and FX3UC PLC to the AS-Interface system. Up to 31 slave units with up to 4 inputs and 4 outputs can be controlled.

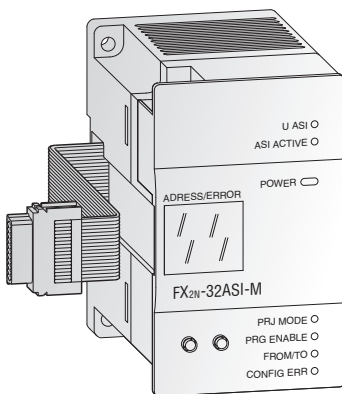

Specifications	FX2N-32ASI-M	
Module type	Master module	
Max. number of I/O points	128 (with FX1N PLC); 256 (with FX3G PLC); 384 (with FX3U/FX3UC PLC)*	
Communication protocol	AS-Interface standard	
Communication speed	kbps	167
Method	APM method (Alternating Pulse Modulation)	
Communication cable	AS-Interface standard cable	
Total extension distance	m	100 (up to 2 repeaters can be used on the system. The total extension distance may be extended by 100m for each repeater.)
Max. number of controllable units	Up to 31 slave modules (up to 4 inputs / 4 outputs per slave)	
I/O refresh time	Max. 5 ms	
Network setup	2 key network setup	
Display	7-segment display for status and diagnosis messages	
Power supply	5 V DC	150 mA (from base unit)
	24 V DC	70 mA external
Related I/O points	8	
Weight	kg	0.2
Dimensions (WxHxD)	mm	55x90x87
<b>Order information</b>	Art. no.	103314

\*Including I/O points in PLC and network.

4 SPECIAL FUNCTION MODULES

Network Module for Ethernet

FX1S  FX1N  FX3G  FX3U  FX3UC

**Ethernet Communications Adapter FX2NC-ENET-ADP**

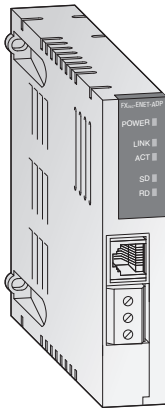

The FX2NC-ENET-ADP communications adapter is an Ethernet interface with 10BASE-T specifications for the FX1S and FX1N series.

The FX2NC-ENET-ADP enables upload, download, monitor and test sequence of programs via Ethernet from a personal computer (GX Developer or MX Component and the virtual COM port driver installed).

*Note: When connecting this adapter module to a FX1S or FX1N PLC the communications adapter FX1N-CNV-BD is required.*

Specifications	FX2NC-ENET-ADP	
Protocol	TCP/IP	
No. of simultaneous open connections	1	
Interface	IEEE802.3u (100BaseTX), IEEE802.3 (10BaseT)	
Connector	RJ45 (to Ethernet), 3 screw terminals (to ground)	
Max. transfer rate	10 Mbit/s	
Cable	CAT5 STP or 3 STP	
Related I/O points	0	
Power supply	5 V DC	135 mA (from base unit)
	24 V DC	—
Weight	kg	0.1
Dimensions (WxHxD)	mm	19.1x90x78
<b>Order information</b>	Art. no.	157447

Network Module for Ethernet

FX1S  FX1N  FX3G  FX3U  FX3UC

**Ethernet Communications Module FX3U-ENET**

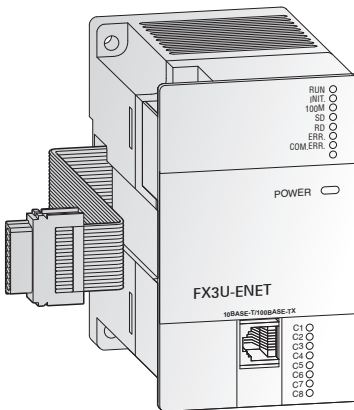

The FX3U-ENET communications module provides the FX3G, FX3U or FX3UC with a direct connection on to an Ethernet network.

With the FX3U-ENET installed an FX3G/FX3U/FX3UC PLC can exchange data quickly and easily with process visualization systems in addition to supporting full program UP/DOWN load as well as comprehensive monitoring support. The module also supports Peer to Peer connection and MC Protocol. It is easily set-up with the FX Configurator-EN software.

*Note: The FX3U-ENET can be used in combination with a FX3G, FX3U- or FX3UC base unit only.*

Specifications	FX3U-ENET	
Protocol	TCP/IP, UDP	
Communication mode	Full-duplex / half-duplex	
No. of simultaneous open connections	8	
Fixed buffer communication	1023 word x 8	
Communication with mail server	SMTP, POP3	
Interface	IEEE802.3u (100BaseTX), IEEE802.3 (10BaseT)	
Connector	RJ45	
Max. transfer rate	100 Mbits/s, 10 Mbit/s	
Max. segment length	m	100
Cable	CAT5 STP or 3 STP	
Power supply	5 V DC	—
	24 V DC	240 mA (from base unit)
Related I/O points	8	
Weight	kg	0.3
Dimensions (WxHxD)	mm	55x90x87
<b>Order information</b>	Art. no.	166086

■ Network Module for Profibus/DP □ FX1S □ FX1N □ FX3G  FX3U  FX3UC

**Master module FX3U-64DP-M**

The FX3U-64DP-M PROFIBUS/DP master module enables you to integrate a MELSEC FX3U or FX3UC PLC system as a class 1 master of a PROFIBUS/DP network. This interface module provides your FX3U/FX3UC base unit with an intelligent Profibus/DP link for the implementation of decentralised control tasks. The FX3U Profibus/DP master provides comprehensive data and alarm processing to the Profibus/DP V1 standard. It is easily set up with the GX Configurator-DP software.

*Note: The FX3U-64DP-M can be used in combination with a FX3U- or FX3UC base unit only.*

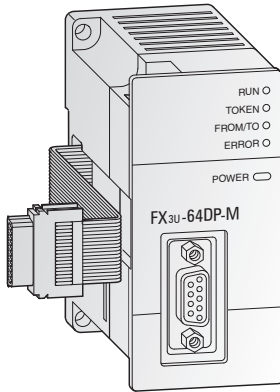

Specifications	FX3U-64DP-M
Module type	Master
Transmission type	Bus network
Transmission data	32 byte/slave (normal service mode) 244 byte/slave (extended service mode)
Interface	PROFIBUS/DP (with 9 pole D-SUB connector)
Max. number of master per configuration	1
Repeaters	3
Max. number of slaves	64
Communications speed	PROFIBUS standard
Communications distance	m Max. 1,200 (depends on communication speed)
Communication cable	PROFIBUS cable with 9-pin D-SUB connector
Power supply	5 V DC 24 V DC
Related I/O points	8
Weight	kg 0.2
Dimensions (WxHxD)	mm 43x90x87
<b>Order information</b>	Art. no. 166085
<b>Accessories</b>	PROFIBUS connector up to 12 Mbaud: PROFICON-PLUS, art. no. 140008 or PROFICON-PLUS-PG, art. no. 140009

■ Network Module for Profibus/DP □ FX1S  FX1N □ FX3G □ FX3U □ FX3UC

**Slave Module FX0N-32NT-DP**

The FX0N-32NT-DP PROFIBUS/DP slave module enables you to integrate a MELSEC FX1N in an existing PROFIBUS/DP network. This interface module provides your FX1N CPU with an intelligent PROFIBUS/DP link for the implementation of decentralised control tasks. It links the system to the master PLC in the PROFIBUS/DP network for efficient and trouble-free data exchange.

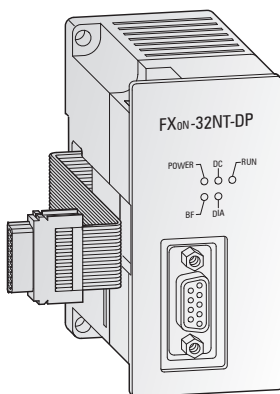

Specifications	FX0N-32NT-DP
Module type	Slave
Interface	PROFIBUS/DP (with 9 pole D-SUB connector)
Communications speed	PROFIBUS standard
Profibus specifications	PROFIBUS standard
Communications distance	m Max. 1,200 (depends on communication speed)
Communication cable	PROFIBUS cable with 9-pin D-SUB connector
Power supply	5 V DC 24 V DC
Related I/O points	8
Weight	kg 0.3
Dimensions (WxHxD)	mm 43x90x87
<b>Order information</b>	Art. no. 62125
<b>Accessories</b>	PROFIBUS connector up to 12 Mbaud: PROFICON-PLUS, art. no. 140008 or PROFICON-PLUS-PG, art. no. 140009

■ Network Module for Profibus/DP □ FX1S □ FX1N  FX3G  FX3U  FX3UC

**FX3U-32DP PROFIBUS DP Slave Module**

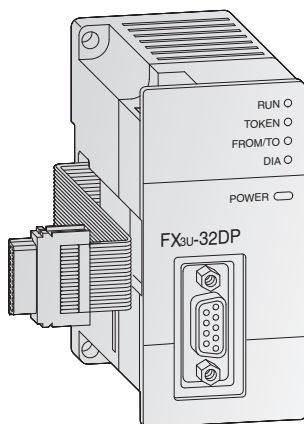

The FX3U-32DP PROFIBUS DP slave module is available for FX3 series main units and allows the attached FX main unit to function as a slave station on a PROFIBUS DP-V1 network. PROFIBUS DP-V1 functionality supports extensive alarm processing and messaging on top of standard cyclic data exchange.

*Note: When attaching the FX3U-32DP to an FX3UC main unit, the FX2NC-CNV-IF interface converter or the FX3UC-1PS-5V power supply unit is required.*

Specifications	FX3U-32DP
Module type	Slave station
Transmission type	Bus network
Transmission data	Max. 144 bytes
Interface	PROFIBUS DP connector
Max. number of slave stations per configuration	8
Communication speed	Max. 12 Mbps
Communication distance	Max. 1,200m (depends on communication speed)
Communication cable	PROFIBUS cable with PROFIBUS DP connector
Related I/O points	8
Power supply	Internal 24 V DC/145 mA
Weight	kg 0.2
Dimensions (WxHxD)	mm 43x90x89
<b>Order information</b>	Art. no. 194214

■ Remote I/O Station for PROFIBUS/DP

**Remote I/O Station FX2N-32DP-IF**

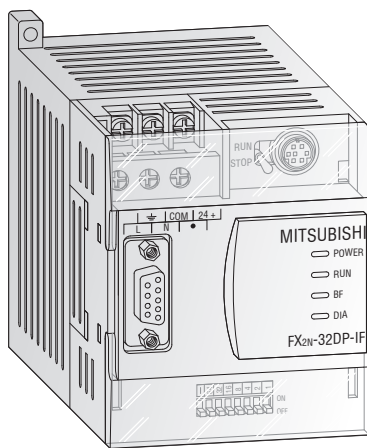

The remote I/O station FX2N-32DP-IF forms an extremely compact communication unit and provides a connection of I/O modules with up to 256 I/O points and/or up to 8 special function modules as an alternative.

It features an entire electrical isolation of the PROFIBUS/DP connector and of the sensor/actuator circuits.

The FX2N-32DP-IF includes a 240 V power supply unit and a 24 V service voltage terminal, e.g. for analog modules. The FX2N-32DP-IF-D is supplied with 24 V DC.

PROFIBUS data such as the baud rate or I/O data can be monitored directly with the programming software or on the hand-held programming units FX-10P/FX-20P/ FX-30P. This facilitates an easy error diagnosis directly on the remote I/O station.

Specifications	FX2N-32DP-IF	FX2N-32DP-IF-D
Power supply	100–240 V AC (+10 %/-15 %) 50/60 Hz	24 V DC (+20 %/-30 %)
Power consumption	30 VA	14 W
Internal current consumption	5 V DC/max. 220 mA (from base unit), 24 V DC/500 mA	5 V DC/max. 220 mA (from base unit)
Interface (connectors)	9-pin D-SUB for PROFIBUS/DP, 8-pin Mini-DIN for PC or programming unit FX-10P/FX-20P/FX-30P	
Communication speed	distance	
	1200 m	kbps 9.6/19.2/45.45/93.75
	1000 m	kbps 187.5
	400 m	kbps 500
	200 m	kbps 1500
100 m	kbps 3000/6000/12000	
Communication distance	m	Max. 1200 (depends on communication speed)
Communication cable	PROFIBUS cable with 9-pin D-SUB connector	
Max. number of controllable I/O points	256	
Related I/O points	0	
Weight	kg	0.4
Dimensions (WxHxD)	mm	75x98x87
<b>Order information</b>	Art. no. 145401	142763

■ Network Module for DeviceNet  FX1S  FX1N  FX3G  FX3U  FX3UC

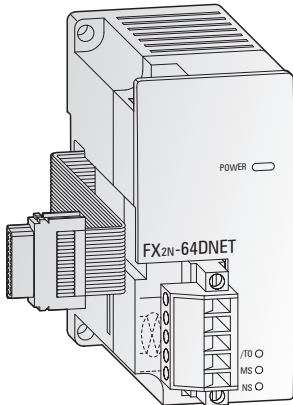

**DeviceNet Slave Module FX2N-64DNET**

The DeviceNet slave module FX2N-64DNET can be used to connect FX3G and FX3U programmable controllers to a DeviceNet network.

The FX2N-64DNET can communicate to the master by the master/slave communication (using the master/slave I/O connection), and to other nodes supporting the UCMM connection by client/server communication (using the UCMM connection).

The communication between the programmable controller and the internal buffer memory of the FX2N-64DNET is handled by FROM/ TO instructions.

Specifications		FX2N-64DNET	
Module type		Slave (group 2)	
Node type		G2 Server	
Station numbers		0–63 points	
Supported communication speeds		kbps	125/250/500
Communication data (open connection)	Master/slave	no. of connections	1 connection (group 2)
		transfer time-out	2,000 ms (ACK time-out)
UCMM client/server		no. of connections	63/63 (group 1, 3)
		data length	Max. 64 bytes per connection
Communication data (I/O connection)		type	Polling, cyclic, change of state
		data length	Max. 64 bytes (fragmentation is possible)
Module ID code		K 7090	
Status displays		Power, module status, network status	
Related I/O points		8	
Power supply	5 V DC	120 mA	
	24 V DC	mA	50 mA
Weight		kg	0.2
Dimensions (WxHxD)		mm	43x90x87
<b>Order information</b>		Art. no.	131708

■ Network Module for CANopen  FX1S  FX1N  FX3G  FX3U  FX3UC

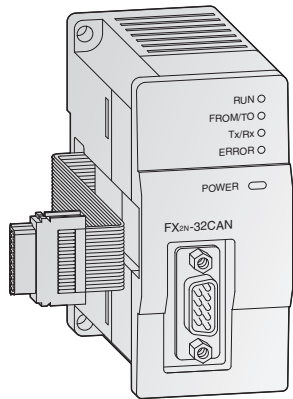

**CANopen Master-Modul FX2N-32CAN**

The FX2N-32CAN communications module makes it possible to connect an FX1N, FX3G or FX3U/FX3UC PLC to an existing CANopen network.

In addition to real-time capabilities and high-speed data transfer at rates of up to 1 Mbit/s the CANopen module also shines with high transfer reliability and simple network configuration. Up to 120 data words can be sent and received as process data objects (30 PDOs). The number of words that can be transmitted in each direction can be set between 1 and 120.

Communication with the module's memory buffer is performed with simple FROM/TO instructions.

Specifications		FX2N-32CAN	
Module type		CANopen master	
Power supply		5 V DC (via base unit)	
CAN standard		ISO 11898/1993	
CANopen standard by CIA		DS-301 version 3.0	
Additional CANopen features		NMT, Guarding, and Guarding request based on DS-302 V2.0. network variables based on DS-405 V1.0	
Max. nbr. of modules that can be connected to the network		30 without repeater; 127 with repeater	
Station numbers		1–127	
Supported baud rate		kBaud	10, 20, 50, 125, 250, 500, 800, 1000
Status displays		RUN, Error, Power, Network status	
Related I/O points		8	
Power supply	5 V DC	290 mA	
	24 V DC	—	
Weight		kg	0.2
Dimensions (WxHxD)		mm	43x90x88.7
<b>Order information</b>		Art. no.	141179

**Modbus & Serial Communication Special Adapters**     FX1S    FX1N    FX3G    FX3U    FX3UC

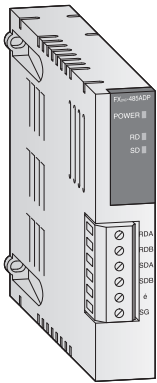

FX2NC-485ADP

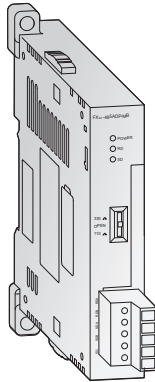

FX3U-485ADP

**Active data modules (RS485)**

The addition of active data interface modules permit active communication between the PLC and surrounding devices. With RS485 communication can be configured as either 1:N multidrop, parallel link or peer to peer operation.

FX3U-485ADP-MB also supports Modbus RTU and Modbus ASCII.

Specifications	FX2NC-485ADP <sup>①</sup>	FX3U-485ADP-MB <sup>②</sup>
Interface	RS485	RS485; Modbus RS485
Communication speed*	kbps 0.3–19.2	0.3–19.2
Max. communication distance	m 500	500
Power supply	5 V DC	Max. 150 mA (from base unit)
	24 V DC	20 mA (from base unit)
Related I/O points	0	0
Weight	kg 0.1	0.08
Dimensions (WxHxD)	mm 19.1x90x78	17.6x90(106)x74
<b>Order information</b>	Art. no. 149111	206191

<sup>①</sup> Application for FX1S/FX1N base unit    <sup>②</sup> Application for FX3G/FX3U/FX3UC base units

\* Speed depends on communication method (Parallel link, N:N Network, No protocol, Dedicated protocol etc.)

Note: When connecting these adapter modules to a FX3U, a communications adapter FX3U-□□□-BD is required. When connecting the FX2NC adapters to a FX1S or FX1N PLC the communications adapter FX1N-CNV-BD is required. When connecting an FX3U adapter to a FX3G PLC the communications adapter FX3G-CNV-ADP is required.

**Interface Modules**     FX1S    FX1N    FX3G    FX3U    FX3UC

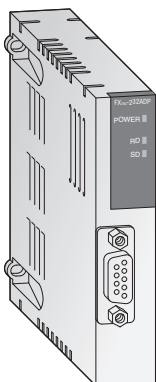

FX2NC-232ADP

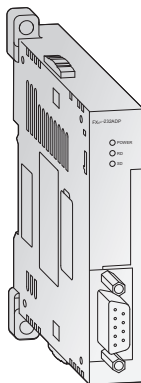

FX3U-232ADP

**Active Data Interface Modules FX2NC-232ADP, FX3U-232ADP**

The additional active data interface modules permit active communication between the PLC and surrounding RS232C peripherals. All device information can be sent or received via these interfaces.

The module is suitable for the connection of printers, bar code readers, PCs and other PLC systems. The communication is handled by the PLC program using the RS instruction.

The connection is to the communications bus on the left side of the controller.

The internal serial RS422 interface is also fully available.

Note: The FX2NC-232ADP requires a FX2N-CNV-BD interface adapter when connecting to a FX1S or FX1N base unit.

The FX3U-232ADP can be used in combination with a FX3G, FX3U or FX3UC base unit only. When connecting the interface modules to a FX3U base unit, an interface or communications adapter FX3U-□□□-B is required. A direct connection without adapter is possible if these modules are connected to a FX3UC base unit.

Specifications	FX2NC-232ADP	FX3U-232ADP
Interface	RS232C with 9 pin D-SUB compact plug (photocoupler isolation)	
Communication speed*	kbps 0.3–19.2	0.3–115.2
Communication distance	m Max. 15	Max. 15
Communication cable	Shielded cable	Shielded cable
Communication mode	Half duplex /Full Duplex	Half duplex /Full Duplex
Protocols	Computer link (dedicated protocol: format1, format4), no protocol, optional programming port	
Format	7 or 8 bits, parity: none/even/odd, stop bits: 1 or 2	7 or 8 bits, parity: none/even/odd, stop bits: 1 or 2
Power supply	5 V DC	100 mA (from base unit)
	24 V DC	30 mA (from base unit)
Related I/O points	0	0
Weight	kg 0.1	0.08
Dimensions (WxHxD)	mm 19.1x90x83	17.6x90(106)x81.5
<b>Order information</b>	Art. no. 149110	165276

\* Speed depends on communication method (No protocol, Dedicated protocol, Protocol for programming tool)

■ Interface Modules

FX1S  FX1N  FX3G  FX3U  FX3UC

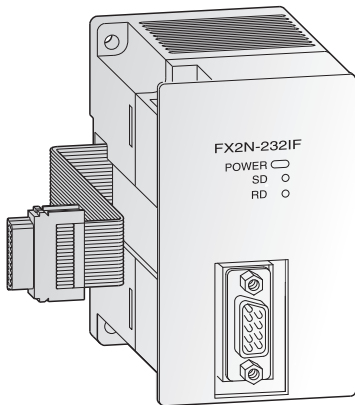

**Interface Module FX2N-232IF**

The interface module FX2N-232IF provides an RS232C interface for serial data communications with the MELSEC FX3U and FX3UC.

Communication with PCs, printers, modems, barcode readers etc. is handled by the PLC program.

The send and receive data are stored in the FX2N-232IF's own buffer memory.

Changes at the user program are not possible via this interface module.

Specifications		FX2N-232IF
Interface		RS232C with 9 pole D-SUB connector (photocoupler isolation)
Communication speed	kbps	0.3–19.2
Communication distance	m	Max. 15
Communication cable		Shielded cable
Communication mode		Full duplex
Protocols		Non protocol mode/start stop synchronisation
Send and receive buffer		512 byte each
Format		7 or 8 bits, parity none/even/odd, stop bits: 1 or 2
Power supply	5 V DC	40 mA (from base unit)
	24 V DC	80 mA
Related I/O points		8
Weight	kg	0.3
Dimensions (WxHxD)	mm	55x90x87
<b>Order information</b>		Art. no. 66640

■ Digital Extension Adapter Boards

FX1S  FX1N  FX3G  FX3U  FX3UC

**Extension Adapters FX1N-4EX-BD, FX1N-2EYT-BD**

The extension adapters for the FX1N series are available with 4 inputs or 2 outputs.

They are installed directly in the controller of the FX1S or FX1N series and therefore do not require any additional installation space.

These adapters are especially advantageous when only few additional I/Os are required and there is not enough room for an adjacent module to be installed.

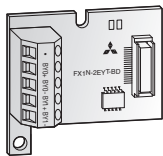

FX1N-2EYT-BD

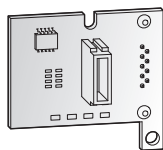

Connector side

Specifications		FX1N-4EX-BD	FX1N-2EYT-BD
Applicable for		Base units FX1S/FX1N	Base units FX1S/FX1N
Integrated inputs/outputs		4	2
Power supply		From base unit	From base unit
Integrated inputs		4	—
Input level	voltage	24 V DC (+20 %/-15 %)	—
	current	5 mA (24 V DC)	—
Integrated outputs		—	2
Output type		—	Transistor
Max. switching voltage	V	—	5–30 V DC
Weight	kg	0.02	0.02
Dimensions (WxHxD)	mm	43x38.5x22	43x38.5x22
<b>Order information</b>		Art. no. 139418	139420



## Analog Adapter Boards

FX1S
  FX1N
  FX3G
  FX3U
  FX3UC

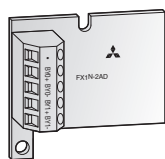

FX1N-2AD-BD

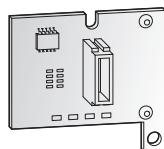

Connector side

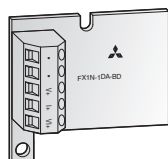

FX1N-1DA-BD

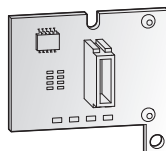

Connector side

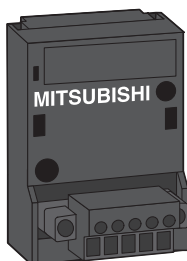

FX3G-2AD-BD

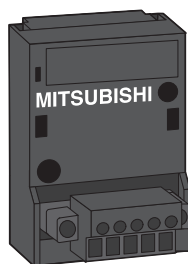

FX3G-1DA-BD

### Analog Adapter Boards FX1N-2AD-BD, FX1N-1DA-BD, FX3G-1DA-BD and FX3G-2AD-BD

The analog input adapter boards FX1N-2AD-BD and FX3G-2AD-BD provide the user with 2 analog inputs.

The boards convert analog process signals into digital values which are further processed by the MELSEC controller.

The analog adapters FX1N-1DA-BD and FX3G-1DA-BD provide the user with 1 analog output. The modules convert digital values from the FX1S/FX1N/FX3G controller to the analog signals required by the process.

Specifications	FX1N-2AD-BD	FX1N-1DA-BD
Applicable for	Base units FX1S/FX1N	Base units FX1S/FX1N
Power supply	From base unit	From base unit
Analog channels	inputs: 2 outputs: —	— 1
Analog input range	0 – +10 V DC/4 – +20 mA	0 – +10 V DC/4 – +20 mA
Input resistance	voltage input: k $\Omega$ 300 current input: $\Omega$ 250	— —
External load	voltage output: k $\Omega$ — current output: $\Omega$ —	2 – 1,000 < 500
Resolution	2.5 mV (12 bits)/8 $\mu$ A (11 bits)	2.5 mV (12 bits)/8 $\mu$ A (11 bits)
Overall accuracy	$\pm 1\%$	$\pm 1\%$
Conversion speed	analog $\rightarrow$ digital: 1 program cycle digital $\rightarrow$ analog: ms —	— 1 program cycle
Related I/O points	0	0
Weight	kg 0.02	0.02
Dimensions (WxHxD)	mm 43x38.5x22	43x38.5x22
Order information	Art. no. 139421	139422

Specifications	FX3G-2AD-BD	FX3G-1DA-BD
Applicable for	Base units FX3G	Base units FX3G
Power supply	From base unit	From base unit
Analog channels	inputs: 2 outputs: —	— 1
Analog input range	0 – +10 V DC/4 – +20 mA	0 – +10 V DC/4 – +20 mA
Input resistance	voltage input: k $\Omega$ 198.7 current input: $\Omega$ 250	— —
External load	voltage output: k $\Omega$ — current output: $\Omega$ —	2 – 1,000 < 500
Resolution	2.5 mV (12 bits)/8 $\mu$ A (11 bits)	2.5 mV (12 bits)/8 $\mu$ A (11 bits)
Overall accuracy	$\pm 1\%$	$\pm 1\%$
Conversion speed	analog $\rightarrow$ digital: 180 $\mu$ s (1 program cycle) digital $\rightarrow$ analog: ms —	— 60 $\mu$ s (1 program cycle)
Related I/O points	0	0
Weight	kg 0.02	0.02
Dimensions (WxHxD)	mm 35x51.2x29.2	35x51.2x29.2
Order information	Art. no. 221265	221266

■ Setpoint Adapter Boards

FX1S  FX1N  FX3G  FX3U  FX3UC

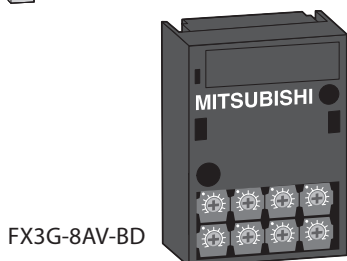
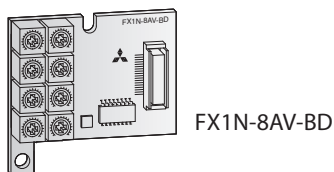

**Analog Setpoint Adapters FX1N-8AV-BD and FX3G-8AV-BD**

The FX□□-8AV-BD analog setpoint adapters enable the user to set 8 analog setpoint values. The analog values of the potentiometers are read into the controller and used as default setpoint values for timers, counters and data registers by the user's PLC programs.

Setpoint value polling and the definition of the potentiometer scales are performed in the PLC program using the dedicated instructions VRRD/VRSC (FNC85/86).

The FX□□-8AV-BD analog setpoint adapters are installed in the expansion slot of the FX1S/FX1N/ FX3G CPU. No additional power supply is required for operation.

Specifications	FX1N-8AV-BD	FX3G-8AV-BD
Applicable for	Base units FX1S/FX1N	Base units FX3G
Power supply	From base unit	From base unit
Adjusting range	8 bit	8 bit
Related I/O points	0	0
Potentiometer evaluation	Via application instruction from the PLC CPU (FNC 85/86)	
Weight	kg 0.02	0.02
Dimensions (WxHxD)	mm 43x38.5x22	35x51.2x12
<b>Order information</b>	Art. no. 130744	221267

■ Communications Adapter Boards

FX1S  FX1N  FX3G  FX3U  FX3UC

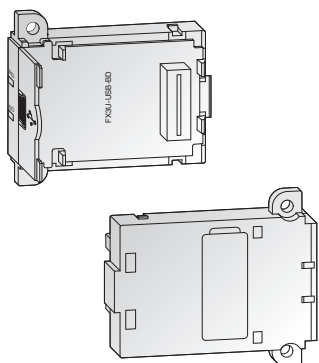

**Adapter Board FX3U-USB-BD**

This adapter board allows direct USB 2.0 connection to the front of the FX3U PLC for program maintenance.

Specifications	FX3U-USB-BD
Applicable for	Base units FX3U
Power supply	5 V DC (from base unit)
Weight	kg 0.02
Dimensions (WxHxD)	mm 19.6x46.1x53.5
<b>Order information</b>	Art. no. 165284

■ Expansion Adapters

FX1S  FX1N  FX3G  FX3U  FX3UC

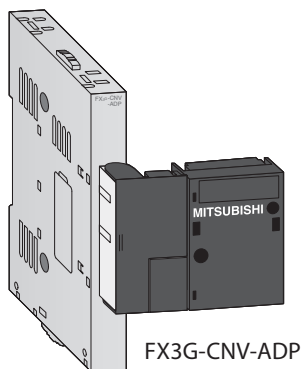

**Expansion Adapters FX1N-CNV-BD, FX3G-CNV-ADP, FX3U-CNV-BD**

The below listed expansion adapters enable the connection of the adapter modules FX□□-□□□ADP on the left hand side of the FX1N, FX3G and FX3U base units.

Specifications	FX1N-CNV-BD	FX3G-CNV-ADP	FX3U-CNV-BD
Applicable for	Base units FX1S/FX1N	Base units FX3G	Base units FX3U
Weight	kg 0.01	0.1	0.01
Dimensions (WxH)	mm 43x38x(D)14	90x14.6x(D)86	19.6x46.1x(D)53.5
<b>Order information</b>	Art. no. 130745	221268	165285

**Interface Adapters**

FX1S  FX1N  FX3G  FX3U  FX3UC

FX3U-232-BD

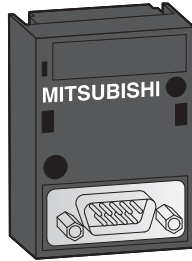
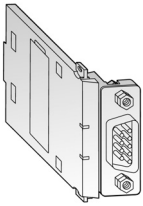

FX3G-232-BD

**Interface Adapters FX1N-232-BD, FX3G-232-BD, FX3U-232-BD**

The FX□□-232-BD interface adapters provide an RS232C interface for serial data communications with the MELSEC FX1S/FX1N/FX3G/FX3U.

Specifications	FX1N-232-BD	FX3G-232-BD	FX3U-232-BD
Applicable for	Base units FX1S/FX1N	Base units FX3G	Base units FX3U
Interface	RS232C with 9 pole D-SUB connector		
Power supply	5 V DC/20 mA (from base unit)		5 V DC/20 mA (from base unit)
Related I/O points	—		
Weight	kg 0.02	0.02	0.02
Dimensions (WxHxD)	mm 43x38.5x22	35x51.2x17.2	19.3x46.1x62.7
<b>Order information</b>	Art. no. 130743	221254	165281

FX3U-422-BD

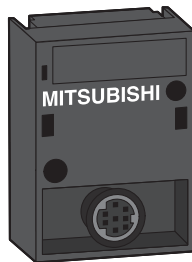
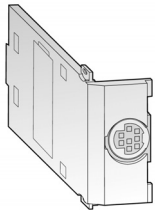

FX3G-422-BD

**Interface Adapters FX1N-422-BD, FX3G-422-BD, FX3U-422-BD**

The FX□□-422-BD interface adapters provide a second RS422 interface for connection of an additional device to the controller (programming unit or operator terminal).

Specifications	FX1N-422-BD	FX3G-422-BD	FX3U-422-BD
Applicable for	Base units FX1S/FX1N	Base units FX3G	Base units FX3U
Interface	RS422 with 8 pole mini DIN connector		
Power supply	5 V DC/60 mA (from base unit)	5 V DC/20 mA (from base unit)	
Related I/O points	—		
Weight	kg 0.01	0.02	0.02
Dimensions (WxHxD)	mm 43x38.5x20	35x51.2x14.9	19.6x46.1x53.5
<b>Order information</b>	Art. no. 130741	221252	165282

FX3U-485-BD

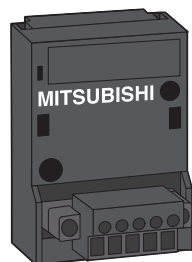
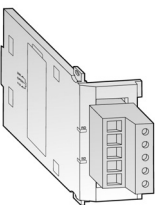

FX3G-485-BD

**Interface Adapters FX1N-485-BD, FX3G-485-BD, FX3U-485-BD**

The interface adapters FX□□-485-BD provide the controller with an additional RS485 interface. The adapter, which is simply inserted into the base unit's expansion slot, enables the configuration of RS485 1:n multidrop, parallel link or peer-to-peer networks with FX1S/FX1N/FX3G/FX3U systems.

Specifications	FX1N-485-BD	FX3G-485-BD	FX3U-485-BD
Applicable for	Base units FX1S/FX1N	Base units FX3G	Base units FX3U
Interface	RS485/RS422		
Power supply	5 V DC/60 mA (from base unit)	5 V DC/20 mA (from base unit)	5 V DC/40 mA (from base unit)
Related I/O points	—		
Weight	kg 0.02	0.02	0.02
Dimensions (WxHxD)	mm 43x38.5x22	35x51.2x29.2	19.6x46.1x69
<b>Order information</b>	Art. no. 130742	221253	165283

**Expansion Adapter**

FX1S  FX1N  FX3G  FX3U  FX3UC

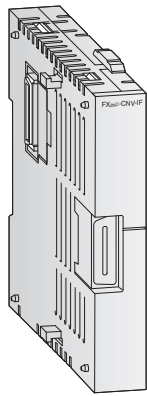

FX2NC-CNV-IF

**FX2NC-CNV-IF**

The FX2NC-CNV-IF expansion adapter connects FX3UC main units with the standard FX0N/FX2N/FX3U right side expansion bus.

Specifications	FX2NC-CNV-IF	
Bus connection	FX3UC bus to FX0N/FX2N/FX3U bus	
Weight	kg	0.3
Dimensions (WxHxD)	mm	90x 4.6x74
<b>Order information</b>	Art. no.	104508

**Memory Media**

FX1S  FX1N  FX3G  FX3U  FX3UC

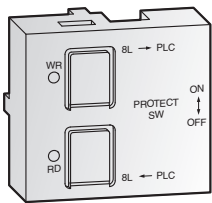

FX1N-EEPROM-8L

**Memory cassettes for FX1S, FX1N and FX3G**

All FX1S, FX1N and FX3G base units are equipped with a slot for the optional, robust FX memory cassettes. By connection of these memory cassettes, the internal memory of the controller is switched off and only the program specified in the respective memory cassette is run.

The memory cassettes can upload/download programs to and from the FX PLC internal memory with the help of 2 buttons.

The memory cassette FX3G-EEPROM-32L can also be placed on top of the standard BD expansion boards.

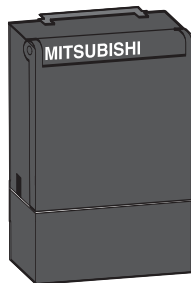

FX3G-EEPROM-32L

Specifications	FX1N-EEPROM-8L	FX3G-EEPROM-32L
Applicable for	Base units FX1S/FX1N	Base units FX3G
Memory type	EEPROM	EEPROM
Size	2000/8000 steps	32000 steps
Protect switch	Provided	Provided
Data transfer buttons	Provided	Provided
<b>Order information</b>	Art. no. 130746	221269

**Memory Media**

FX1S  FX1N  FX3G  FX3U  FX3UC

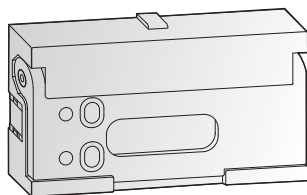

FX3U-FLROM-64L

**Memory Cassettes for FX3U/FX3UC**

The memory cassette can be installed at the main unit, and when installed, the memory cassette's internal program is used in place of the internal RAM memory.

The FX3U-FLROM-64L features additional data transfer buttons.

Specifications	FX3U-FLROM-16	FX3U-FLROM-64	FX3U-FLROM-64L
Applicable for	Base units FX3U/FX3UC	Base units FX3U/FX3UC	Base units FX3U/FX3UC
Number of steps	16,000	64,000	64,000
Memory type	Flash memory	Flash memory	Flash memory
Protect switch	Provided	Provided	Provided
Data transfer buttons	Not provided	Not provided	Provided
Dimensions (WxHxD)	mm 37x20x6.1	37x20x6.1	37x20x6.1
<b>Order information</b>	Art. no. 165278	165279	165280

Terminal Blocks

FX1S  FX1N  FX3G  FX3U  FX3UC

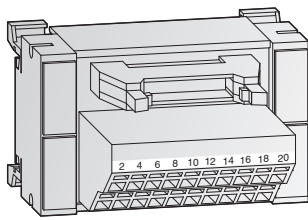

TB-20C

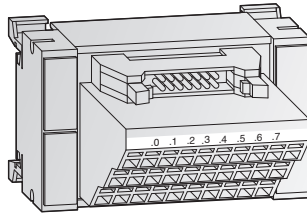

TB-□EX□

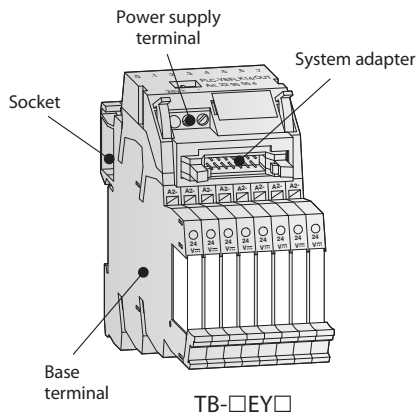

TB-□EY□

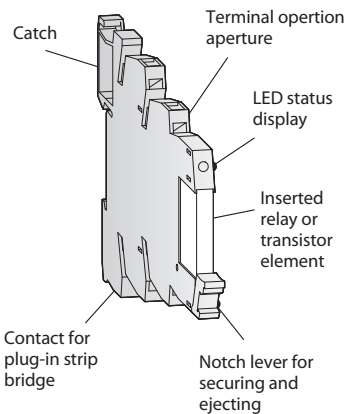

These terminal blocks are adapter modules that simplify the wiring of the inputs and outputs of the FX3UC main units with ribbon cable connectors. This practical, time-saving wiring system also improves the performance of the outputs. Special terminal blocks are also available for the FX3U/FX3UC positioning modules with ribbon cable connectors. Input blocks, output blocks and combined I/O blocks are available, with a choice of different terminal types.

The TB-□EX□ input blocks are fitted with rows of bridged connectors for 24V/0V terminals, which make wiring quick and easy.

The TB-8EY-S and TB-8EY-C output blocks consist of 8 standard terminals and a system adapter. The standard terminals can be populated with relay or transistor elements, which makes it possible to configure the system for much higher output currents.

Preconfigured system cabling is available for all the terminal blocks (see next page).

Specifications	TB-8EY-S	TB-8EY-C	TB-16EX-S	TB-16EX-C
Type	Input block	Input block	Input block	Input block
Integrated inputs	8	8	16	16
Design	Initiator module with potential terminals			
Connection type	Screw terminals	Spring terminals	Screw terminals	Spring terminals
Application	FX2NC series base and extension modules with connectors			
Dimensions (WxHxD) mm	75x45x54	75x45x63	116x45x54	116x45x63
<b>Order information</b>	Art. no. 149144	149145	149021	149022
<b>Accessories</b>	Connection Cable (see following page)			

Specifications	TB-8EY-S	TB-8EY-C	TB-20-S	TB-20C
Type	Output block	Output block	Input/output block	Input/output block
Channels	8	8	8/16	8/16
Design	Socket for relay or transistor elements		20 pin terminal module	
Connection type	Screw terminals	Spring terminals	Screw terminals	Spring terminals
Application	FX2NC series base and extension modules with connectors		FX2N series positioning module	
Dimensions (WxHxD) mm	49.6x100x94	49.6x100x94	75x45x52	75x45x52
<b>Order information</b>	Art. no. 149044	149045	149148	149023
<b>Accessories</b>	Pluggable function elements (see below), Connection cable (see following page)		Connection cable (see following page)	

The transistor and relay elements are plugged directly into the standard terminals in the TB-8EY-S or TB-8EY-C modules. All the elements feature a status LED, protection against reverse polarity connection and a freewheeling diode.

Neighbouring terminals with identical voltages can be connected with plug-in strip bridge connectors, which can be cut to length as required.

Specifications	TB-8RELAY-6A	TB-8TRANSISTOR-2A
Output type	Relay with 1 switch-over contact	Transistor (with optocoupler)
Number of elements	8	8
Rated input voltage	24 V DC	24 V DC
Switching voltage (min./max.)	12 V AC/DC; 250 V AC/DC	3 V DC; 33 V DC
Limit permanent current	6 A	3 A (at 20 °C), 2 A (at 60 °C)
Max. breaking capacity	140 W (24 V DC), 1500 VA (250 V AC)	—
Ambient temperature	-20—+60 °C	-20—+60 °C
<b>Order information</b>	Art. no. 149034 (set with 8 elements)	149035 (set with 8 elements)
<b>Accessories</b>	Insulated infinite pin bridge for potential isolation, TB-PIB-RD, color red, art.-no.: 149146; Insulated infinite pin bridge for potential isolation, TB-PIB-BL, color blue art.-no.: 149147; Isolation plate TB-5P for lateral base terminal connection, art.-no.: 149158	

■ Terminal Connection Cable

FX1S  FX1N  FX3G  FX3U  FX3UC

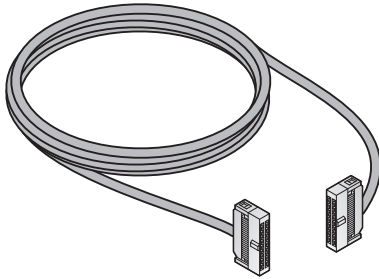

These preconfigured cables enable quick, error-free wiring of the terminal blocks of the positioning modules for the FX3U and FX3UC series fitted with ribbon cable connectors. The cables are available in a choice of lengths between 1 and 5 m. Other lengths are also possible by special order.

Specifications	TB-EX-CAB-1M	TB-EX-CAB-3M	TB-EX-CAB-5M
Application	For TB-20-□ (1:1 cable)		
Length	m 1	3	5
<b>Order information</b>	Art. no. 149038	149039	149040

Specifications	TB-EY-CAB-1M	TB-EY-CAB-3M	TB-EY-CAB-5M
Application	For 2 x terminal blocks TB-8EY-S or TB-8EY-C (Y cable)		
Length	m 1	3	5
<b>Order information</b>	Art. no. 149041	149042	149043

■ Connection terminals

FX1S  FX1N  FX3G  FX3U  FX3UC

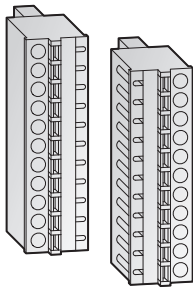

The base unit FX2NC-16MR-T-DS and the extension units FX2NC-16EX-T-DS and FX2NC-16EYR-T-DS are fitted with screw terminals as standard equipment. These plug-in terminals can easily be replaced with spring terminals if required. Two replacement terminal units are required for each module with 16 I/Os.

Specifications	TB-CON-5-C	TB-CON10-C
Number of terminal points	5	10
Connection type	Spring terminals	Spring terminals
Application	Adapter modules	Adapter modules and FX2NC-16EX-T-DS / FX2NC-16EYR-T-DS extension modules
Dimensions (WxHxD)	mm 12.5x20x21	12.5x20x21
<b>Order information</b>	Art. no. 221539	149036

■ 24 V Power Supply Unit

☑ ALPHA ☑ FX1s ☑ FX1N ☑ FX3G ☑ FX3U ☑ FX3UC

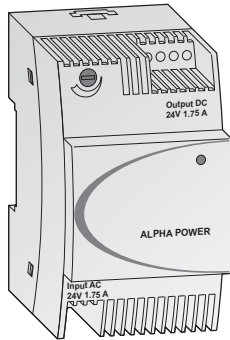

The ALPHA-POWER units are a convenient power supply for 24 V units and other external devices. They come with mounting system for wall or DIN rail mounting and their dimensions are matched to those of the ALPHA family.

Up to 5 power supply units can be installed together for redundant mode operation or connected in parallel for more power. The units have an integrated thermal overload protection circuit and a POWER LED. The output voltage is adjustable.

Specifications	ALPHA POWER 24-0.75	ALPHA POWER 24-1.75	ALPHA POWER 24-2.5
Application	Power supply for 24 V DC Alpha base units		
General specifications	Conforms to FX family and ALPHA base units		
Nominal input voltage	100–240 V (45–65 Hz)		
Output voltage	24 V DC (+/-1 %)		
Nominal output current	0.75 A (at T=55 °C)	1.75 A (at T=55 °C)	2.5 A (at T=55 °C)
Max. output current	1.4 A	3.75 A	4.4 A
Ambient temperature	-25–+55 °C (operation), -40–+85 °C (storage)		
Ambient humidity	Max. 95 % (no condensation)		
Weight	kg	0.1	0.2
Dimensions (WxHxD)	mm	36x90x61	54x90x61
Order information	Art. no.	209029	209030
			209031

■ 5 V Power Supply Unit

☐ FX1s ☐ FX1N ☐ FX3G ☑ FX3U ☑ FX3UC

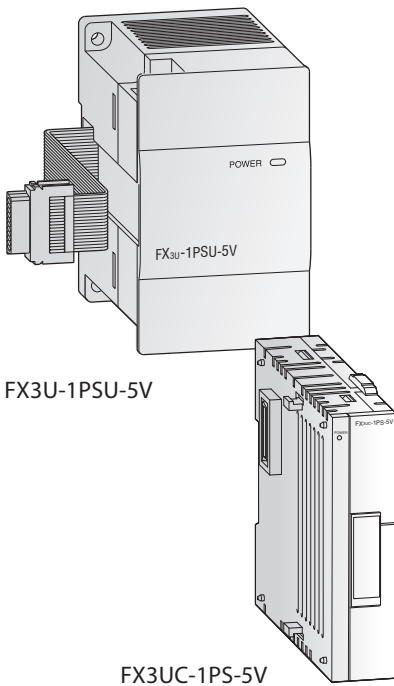

The power supply modules FX3U-1PSU-5V and FX3UC-1PS-5V are used to reinforce the build-in 5 V DC and 24 V DC power supply of a FX3G/FX3U/FX3UC main unit. They do not occupy any I/O points and deliver up to 1 A more current for the 5 V system bus (for special function modules).

Up to two FX3U-1PSU-5V or FX3UC-1PS-5V modules can be used. Both modules have an integrated overload protection available.

*Note: The FX3U-1PSU-5V can't be used with a 24 V base unit!*

*When connecting an input extension module (incl. FX2N-8ER-ES/UL, FX2N-8ER) to the FX3U-1PSU-5V, supply the power for it from the 24 V DC service power supply of the connected main unit or powered extension unit on the upstream side.*

Specifications	FX3U-1PSU-5V	FX3UC-1PS-5V
Application	Power supply for the FX3G/FX3U system bus	Power supply for the FX3UC system bus
General specifications	Conforms to FX family base units	
Nominal input voltage	100–240 V (50/60 Hz)	
Output voltage	5 V DC/24 V DC	5 V DC
Max. output current	5 V DC 24 V DC	5 V DC
	1 A at 40 °C; 0.8 A at 55 °C	1 A
	0.3 A at 40 °C; 0.2 A at 55 °C	—
Ambient temperature	-25–+55 °C (operation), -40–+85 °C (storage)	
Ambient humidity	Max. 95 % (no condensation)	
Weight	kg	0.3
Dimensions (WxHxD)	mm	55x90x87
Order information	Art. no.	169507
		210086

■ Backup Batteries

☐ FX1s ☐ FX1N ☑ FX3G ☑ FX3U ☑ FX3UC

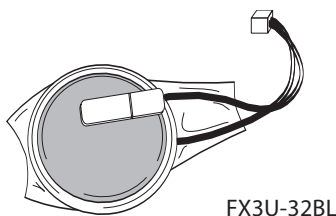

**Batteries**

The battery buffers the internal RAM of the MELSEC PLC in the event of a voltage failure.

The battery FX2NC-32BL is suitable for the positioning modules FX2N-20GM.

The battery FX3U-32BL can be used for all base units of the MELSEC FX3G/FX3U/FX3UC series.

Specifications	FX2NC-32BL	FX3U-32BL
Applicable for	FX2N-20GM module	Base unit FX3U
Order information	Art. no.	128725
		165286

**Cables**

☑ FX1S ☑ FX1N ☑ FX3G ☑ FX3U ☑ FX3UC

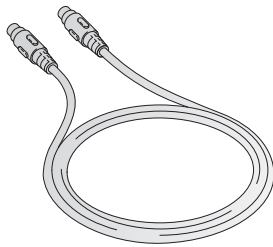

FX-20P-CAB0

**FX Series connection cables**

The cable listed in the following tables are used for FX Series PLC programming, positioning applications, block connections and interface conversion.

**Connection cable for RS232C peripherals**

Specifications	F2-RS-5CAB	F2-232CAB-1	FX-232CAB-1
Application	FX2N-1RM to resolver	PC to FX-232AWC-H	PC to GOT
Length	m 5.0	3.0	3.0
<b>Order information</b>	Art. no. 76160	76163	124972

**Connection cable for RS-422 peripherals**

Specifications	FX-422CAB0	FX-422CAB	FX-422CAB-150
Application	FX-232AWC-H to FX□ PLC	FX-232AWC-H to FX PLC	FX-232AWC-H to FX PLC
Length	m 1.5	0.3	1.5
<b>Order information</b>	Art. no. 76094	25949	—

**Connection cable for programming unit**

Specifications	FX-20P-CAB0	FX-20P-CAB	FX-20P-CADP
Application	FX-20P-G/FX-30P to FX□ PLC	FX-20P-E to FX PLC	FX-20P-CAB to FX□ PLC
Length	m 1.5	1.5	0.3
<b>Order information</b>	Art. no. 55917	30815	31870

**Connection cable for extension bus**

Specifications	FX0N-65EC
Application	PLC bus cable for two-stage-configuration with extension units FX□□-□□ES
Length	m 0.65
<b>Order information</b>	Art. no. 45348

**Interface converter**

Specifications	FX-USB-AW	FX-232AWC-H
Application	USB to RS422 converter	RS422 to RS232C converter
Dimensions	m 0.063+3.0	0.25x0.8x0.6
<b>Order information</b>	Art. no. 165288	159642

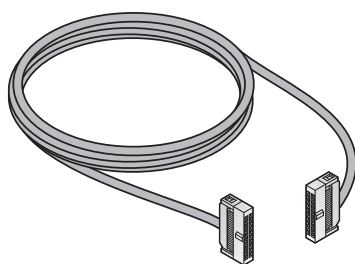

FX-16E-500CAB

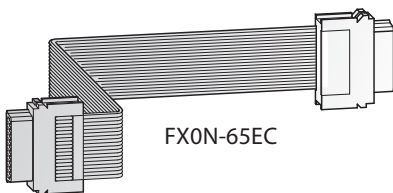

FX0N-65EC

**Programming Cables**

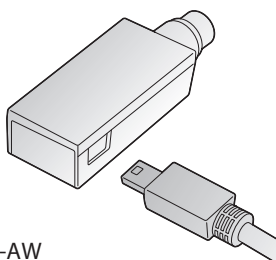

FX-USB-AW

The USB to RS-422 converter FX-USB-AW is used for the connection between the PLC and a serial interface of a personal computer. The converter is divided into 2 parts and thus universally applicable for all FX-series PLCs.

The SC-09 programming cable is used for the connection between the PLC and a serial interface of a personal computer. The cable is divided into 2 parts and thus universally applicable for all Mitsubishi PLCs.

	FX-USB-AW	SC-09
Connection on PC side	USB	9-pin D-SUB
<b>Order information</b>	Art. no. 165288	43393



■ Display Modules

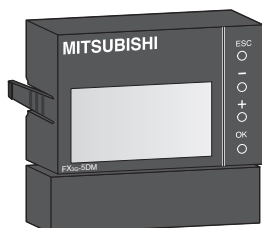
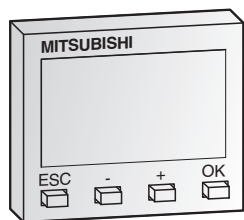

**Display Module FX1N-5DM and FX3G-5DM**

The display modules FX1N-5DM and FX3G-5DM are inserted directly with space-saving into the controller and enable monitoring and editing of the data stored in the PLC. The display module e.g. can be used instead of digital switches and external 7-segment displays in very confined areas.

Specifications	FX1N-5DM	FX3G-5DM
Applicable for	Base units FX1S/FX1N	Base units FX3G series
Display	LCD (with backlight)	LCD (with backlight)
Power supply	5 V DC ±5 % (from base unit)	5 V DC ± 5 % (from base unit)
Current consumption	mA 110	n/a
Weight	kg 0.02	0.02
Dimensions (WxHxD)	mm 40x32x17	49x34x12
<b>Order information</b>	Art. no. 129197	221270

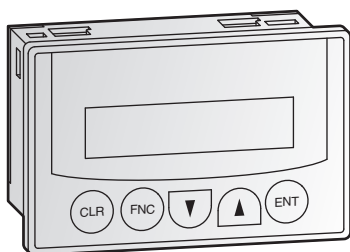

**Control and Display Panel FX-10DM-E**

The control and display panel FX-10-DM-E provides a key-oriented user-interface and enables you to monitor and edit process data in the PLC.

The display is arranged in 2 rows of 16 characters each. Functions can be invoked and values can be edited using the panel keys.

Specifications	FX-10DM-E
Applicable for	All base units FX1S/FX1N/FX2N/FX3U
Display	LCD (with backlight)
Resolution	2x16 signs (80x16 pixles)
Power supply	5 V DC ±5 % (from base unit)
Current consumption	mA 220
Weight	kg 0.02
Dimensions (WxHxD)	mm 96x62x32
<b>Order information</b>	Art. no. 132600

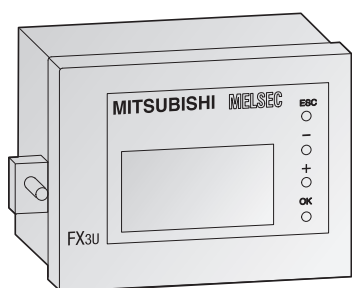

Panel FX3U-7DM with built-in holder FX3U-7DM-HLD

**Control and Display Panel FX3U-7DM, Holder FX3U-7DM-HLD**

The FX3U-7DM display module can be incorporated in the main unit, or can be installed in the enclosure using the FX3U-7DM-HLD display module holder.

Specifications	FX3U-7DM	FX3U-7DM-HLD
Applicable for	Base units FX3U	Base units FX3U
Display	16 letters x 4 lines	—
Resolution	—	—
Power supply	5 V DC (from base unit)	—
Current consumption	mA 20	—
Extension cable	—	Included
Weight	kg 0.02	0.01
Dimensions (WxHxD)	mm 48x35x11.5	66.3x41.8x13
<b>Order information</b>	Art. no. 165268	165287

For further control and operator terminals please refer to the technical catalogue HMI.

### Dimensions of the ALPHA series

AL2-14M□-□, AL2-24M□-□

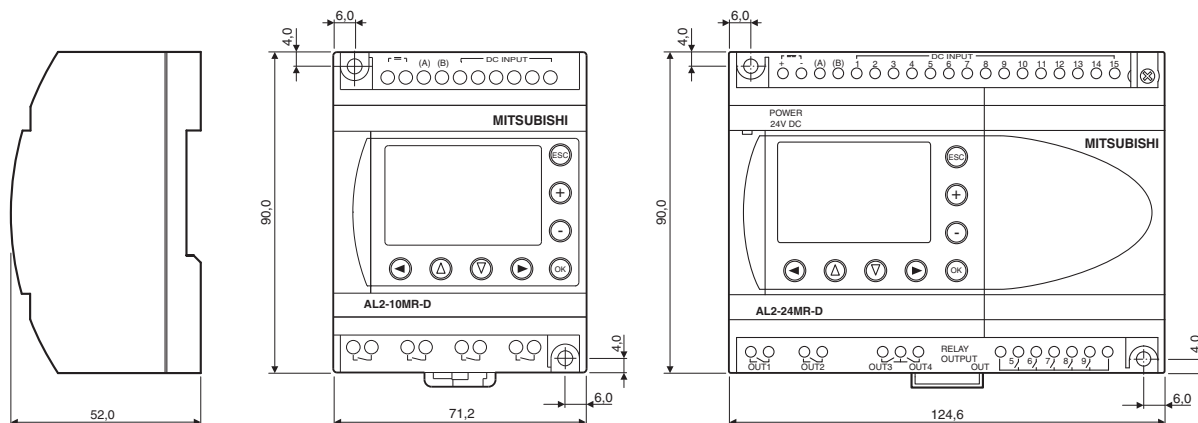

AL2-4EY□, AL2-2DA

AL2-ASI-BD

AL2-2PT-ADP, AL2-2TC-ADP

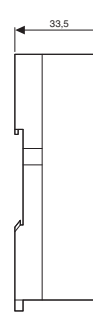
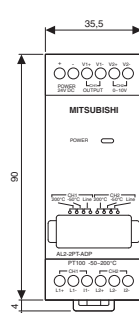
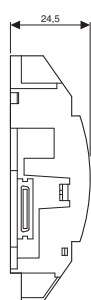
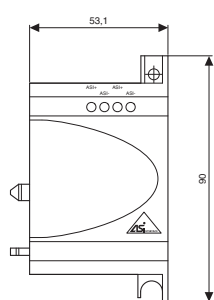
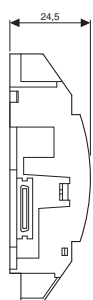
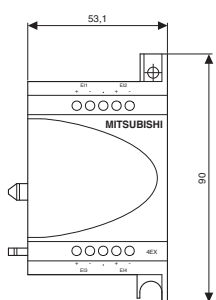

6  
DIMENSIONS

All dimensions in mm

Dimensions of Base Units FX1S

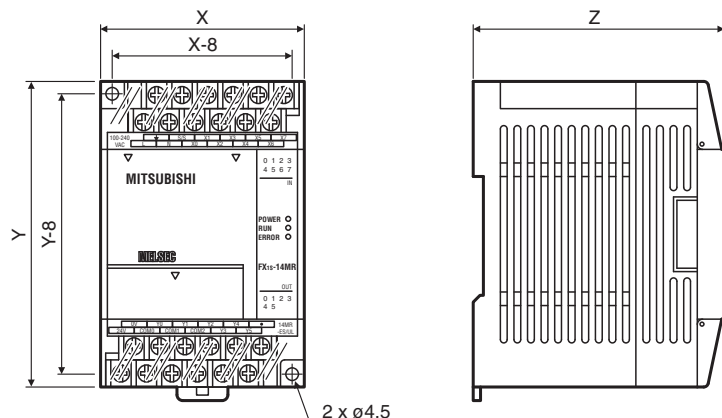

Base unit	X	Y	Z
FX1S-10MR-DS	60	90	49
FX1S-10MR-ES/UL	60	90	75
FX1S-10MT-DSS	60	90	49
FX1S-14MR-DS	60	90	49
FX1S-14MR-ES/UL	60	90	75
FX1S-14MT-DSS	60	90	49
FX1S-20MR-DS	75	90	49
FX1S-20MR-ES/UL	75	90	75
FX1S-20MT-DSS	75	90	49
FX1S-30MR-DS	100	90	49
FX1S-30MR-ES/UL	100	90	75
FX1S-30MT-DSS	100	90	49

All dimensions in mm

Dimensions of Base Units FX1N

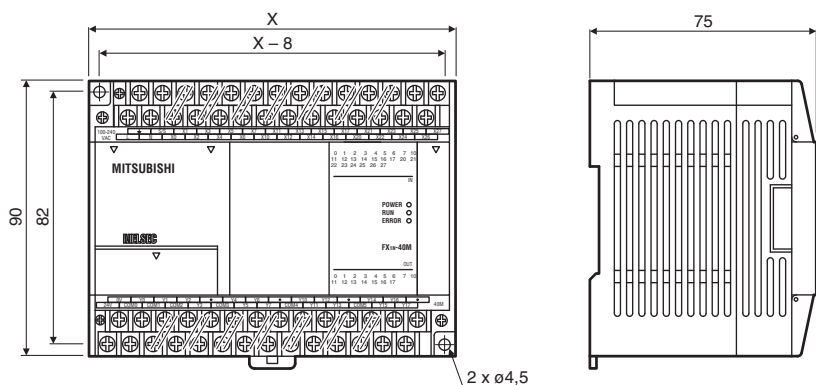

Base unit	X
FX1N-14MR□□□	90
FX1N-14MT□□□	90
FX1N-24MR□□□	90
FX1N-24MT□□□	90
FX1N-40MR□□□	130
FX1N-40MT□□□	130
FX1N-60MR□□□	175
FX1N-60MT□□□	175

All dimensions in mm

Dimensions of Base Units MELSEC FX3G

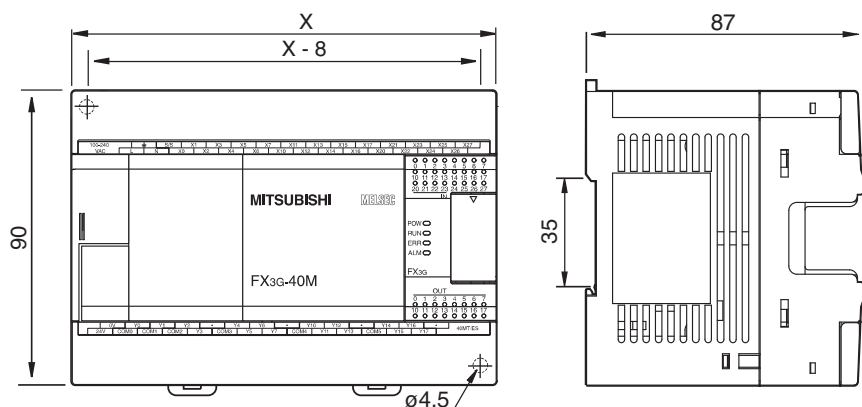

Base unit	X
FX3G-14	90
FX3G-24	90
FX3G-40	130
FX3G-60	175

All dimensions in mm

**Dimensions of Base Units FX3U**

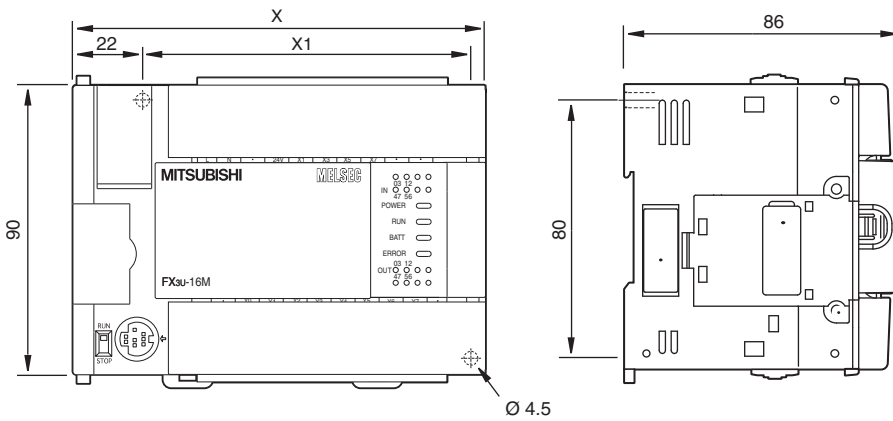

**Base Units**

Type	X	X1
FX3U-16M□□□	130	103
FX3U-32M□□□	150	123
FX3U-48M□□□	182	155
FX3U-64M□□□	220	193
FX3U-80M□□□	285	258
FX3U-128M□□□	350	323

All dimensions in mm

**Dimensions of Base Units FX3UC**

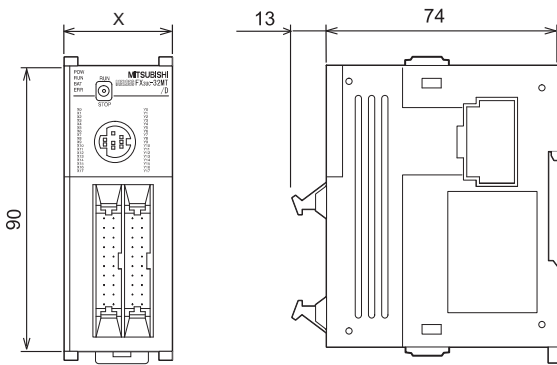

**Base Units**

Type	X
FX3UC-16MT/DSS	34
FX3UC-32MT/DSS	34
FX3UC-64MT/DSS	59.7
FX3UC-96MT/DSS	85.4

All dimensions in mm

**Dimensions of Adapter Modules FX3U and Extension Adapters**

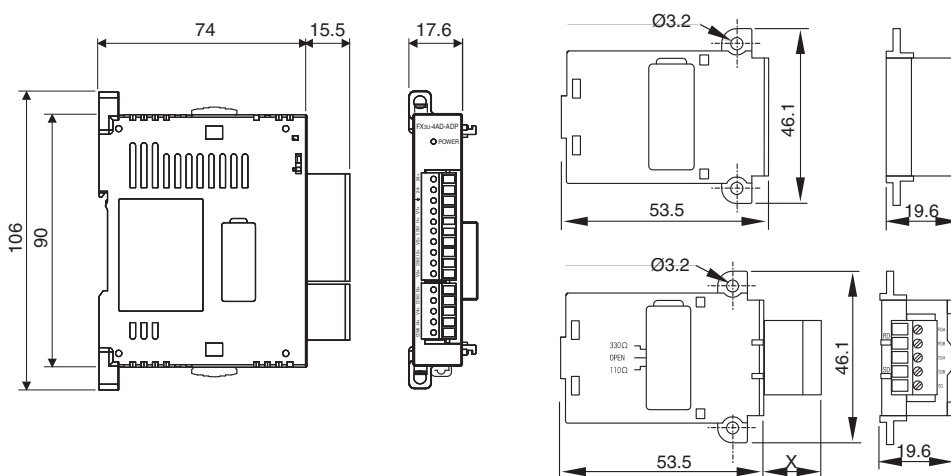

**Extension Adapters**

Type	X
FX3U-CNV	—
FX3U-USB	—
FX3U-485	15,5
FX3U-422	—
FX3U-232	9,2

All dimensions in mm

### Dimensions of Compact Extension Units FX0N

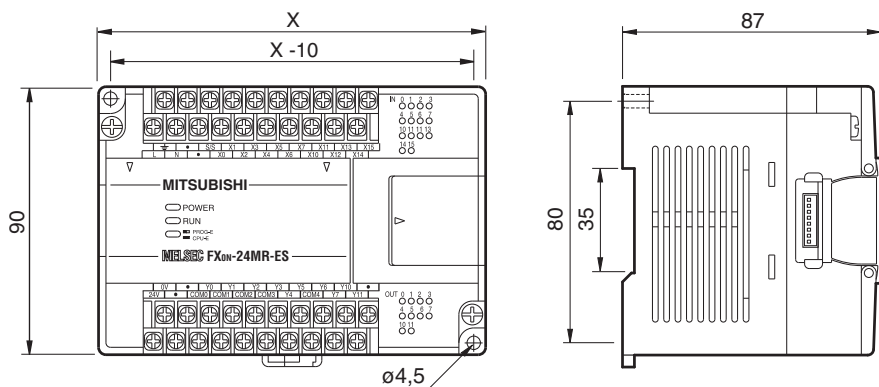

Type	X
FX0N-40ER-DS	150
FX0N-40ER-ES/UL	150
FX0N-40ET-DSS	150

All dimensions in mm

### Dimensions of Compact Extension Units and Modular Extension Blocks MELSEC FX2N

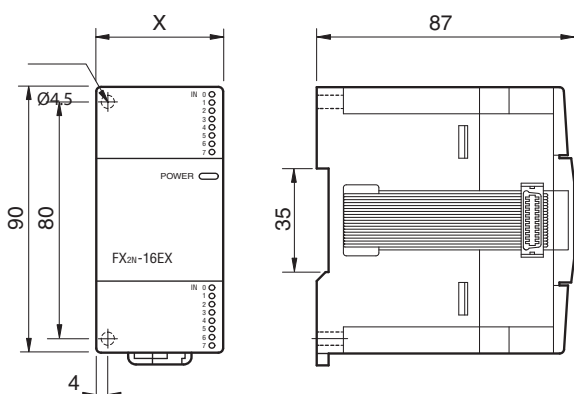

#### Compact Extension Units

Type	X
FX2N-32E□□□	150
FX2N-48E□□□	182
FX2N-48ER-UA1/UL	220

#### Modular Extension Blocks

Type	X
FX2N-8E□□□	43
FX2N-16E□□□	40

All dimensions in mm

### Dimensions of Modular Extension Blocks FX2NC

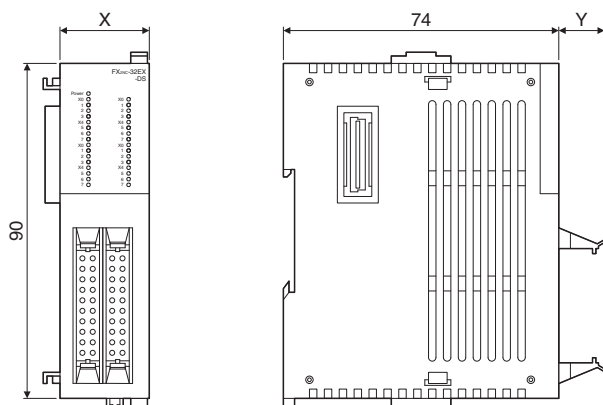

#### Extension Blocks

Type	X	Y
FX2NC-16EX-DS	14.6	13
FX2NC-16EYT-DSS	14.6	13
FX2NC-16EX-T-DS	20.2	15
FX2NC-16EYR-T-DSS	24.2	15
FX2NC-32EX-DS	26.2	13
FX2NC-32EYT-DSS	26.2	13

All dimensions in mm

Dimensions of Special Function Modules MELSEC FX2N

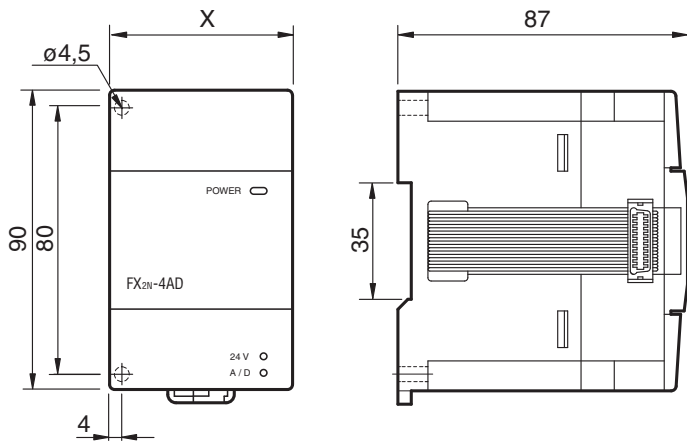

Special Function Modules FX0N/FX2N

Type	X
FX0N-3A	43
FX2N-2DA	43
FX2N-2AD	43
FX2N-4DA	55
FX2N-4AD	55
FX2N-4AD-TC	55
FX2N-4AD-PT	55
FX2N-1HC	55
FX2N-1PG-E	43
FX2N-10PG	43
FX2N-2LC	55
FX2N-5A	55
FX2N-232-IF	55
FX2N-32ASI-M	55
FX2N-32CCL	43
FX2N-32CAN	43
FX2N-64DNET	43

FX2N-8AD

FX2N-32DP-IF

All dimensions in mm

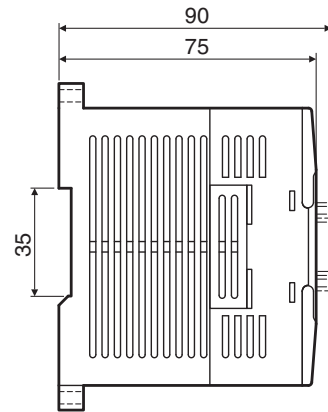
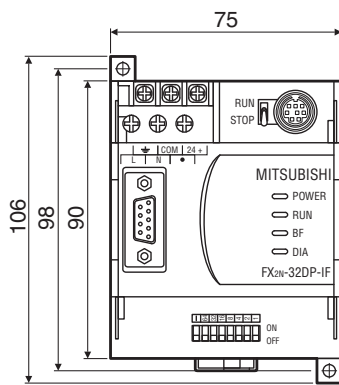
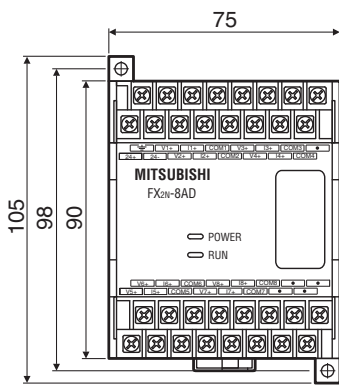

Dimensions of Special Function Modules MELSEC FX3U/FX3UC

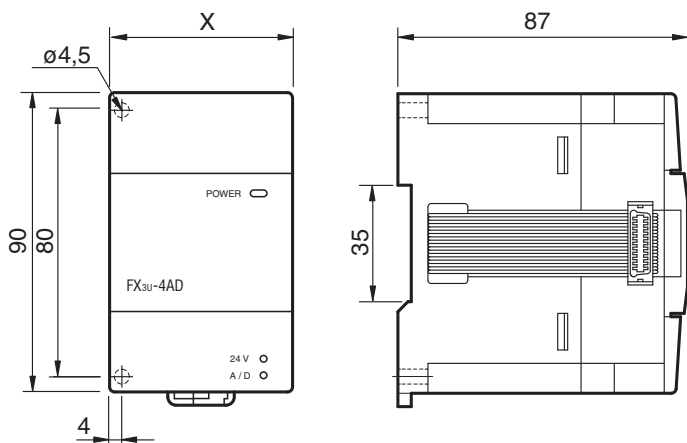

Special Function Modules FX3U/FX3UC

Type	X
FX3U-2HC	55
FX3U-3A-ADP	17.6
FX3U-4DA	55
FX3U-4AD	55
FX3U-4LC	90
FX3U-CF-ADP	45
FX3U-ENET	55
FX3U-20SSC-H	55
FX3U-64CCL	55
FX3U-64DPM	43
FX3U-1PSU-5V	55
FX3UC-4AD	20.2
FX3UC-1PS-5V	24.2

All dimensions in mm

### Dimensions of Adapters FX1N and FX3G

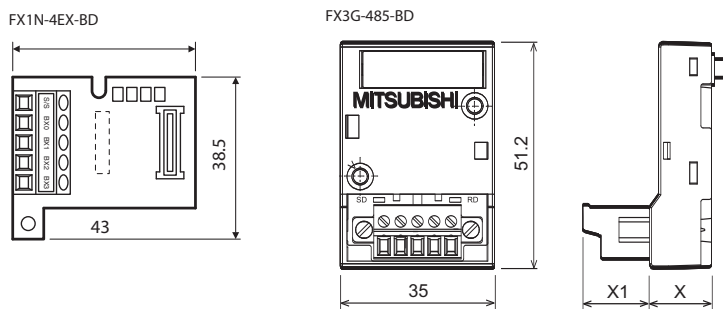

#### FX3G Extension Adapters

Type	X	X1
FX3G-1DA-BD	14.1	15.1
FX3G-232-BD	12	5.2
FX3G-2AD-BD	14.1	15.1
FX3G-422-BD	12	2.9
FX3G-485-BD	14.1	15.1
FX3G-8AV-BD	12	-

All dimensions in mm

### Dimensions for Terminal Blocks

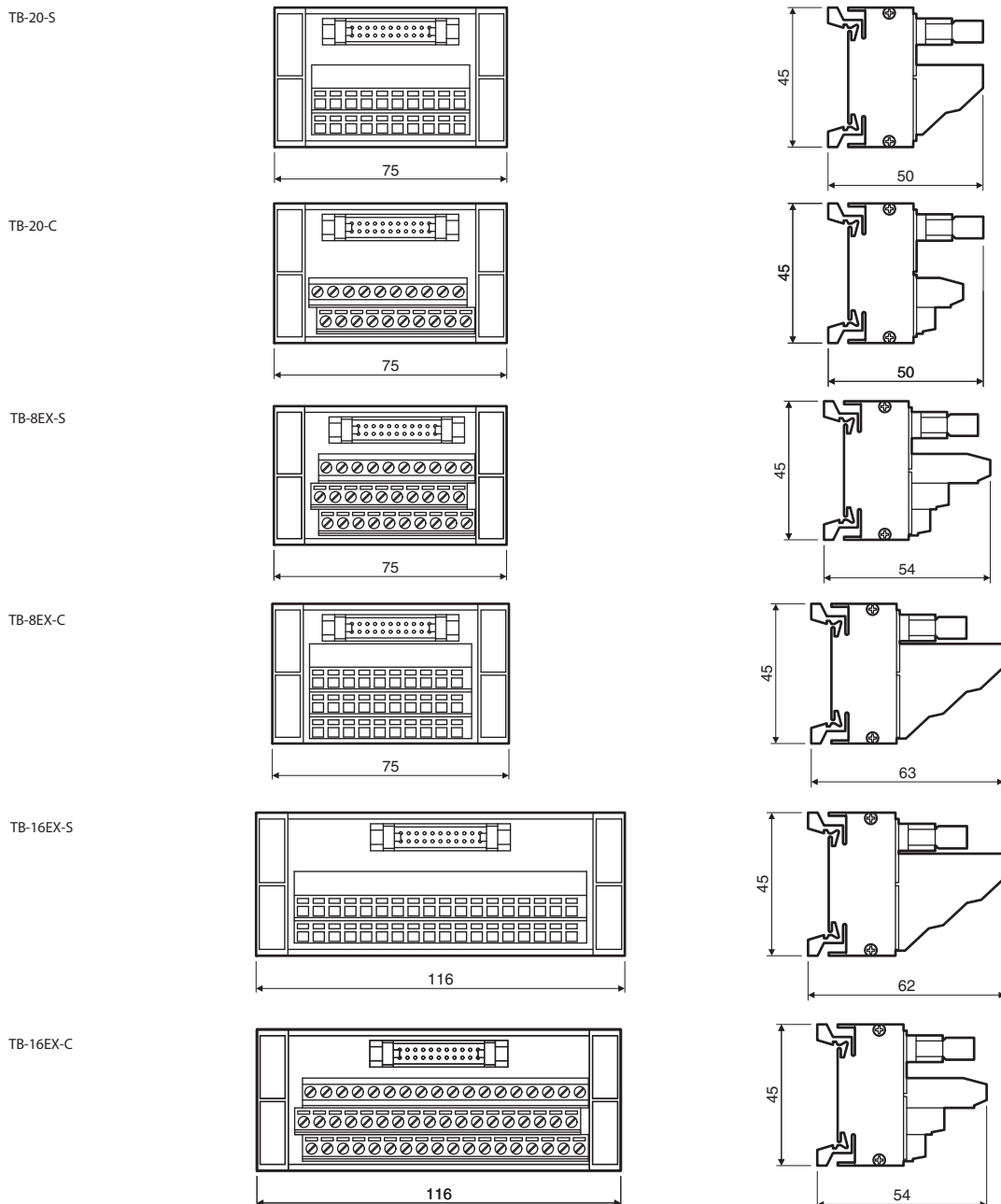

All dimensions in mm

Dimensions for Accessories

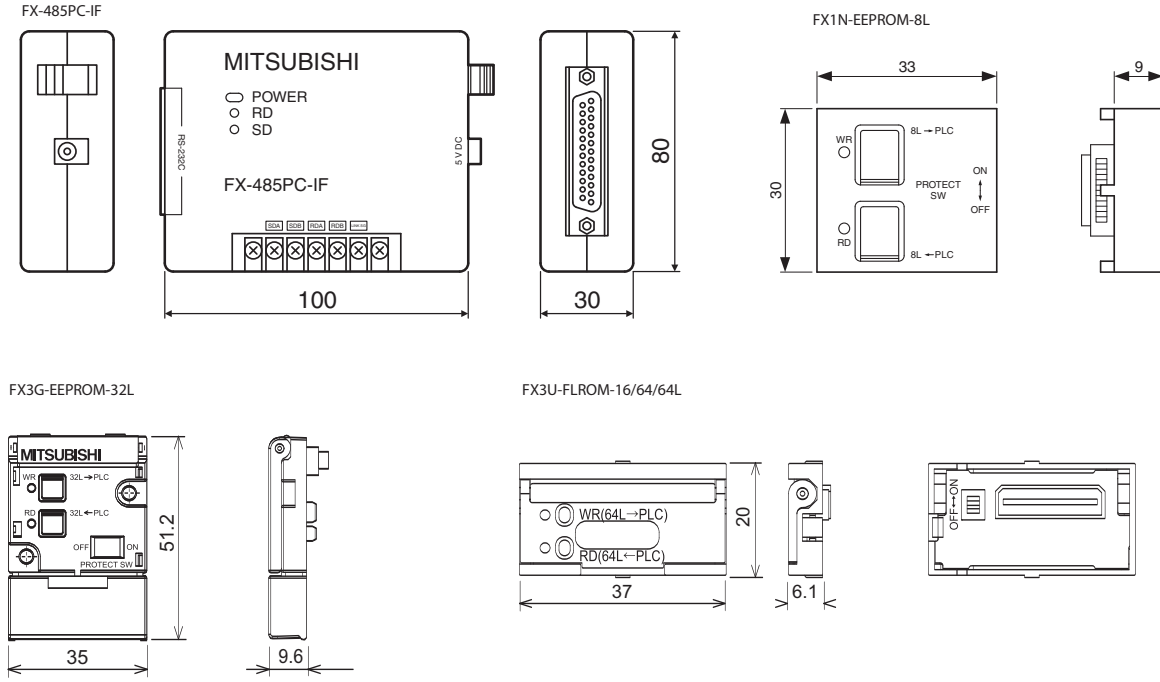

All dimensions in mm

Dimensions for Display Panels

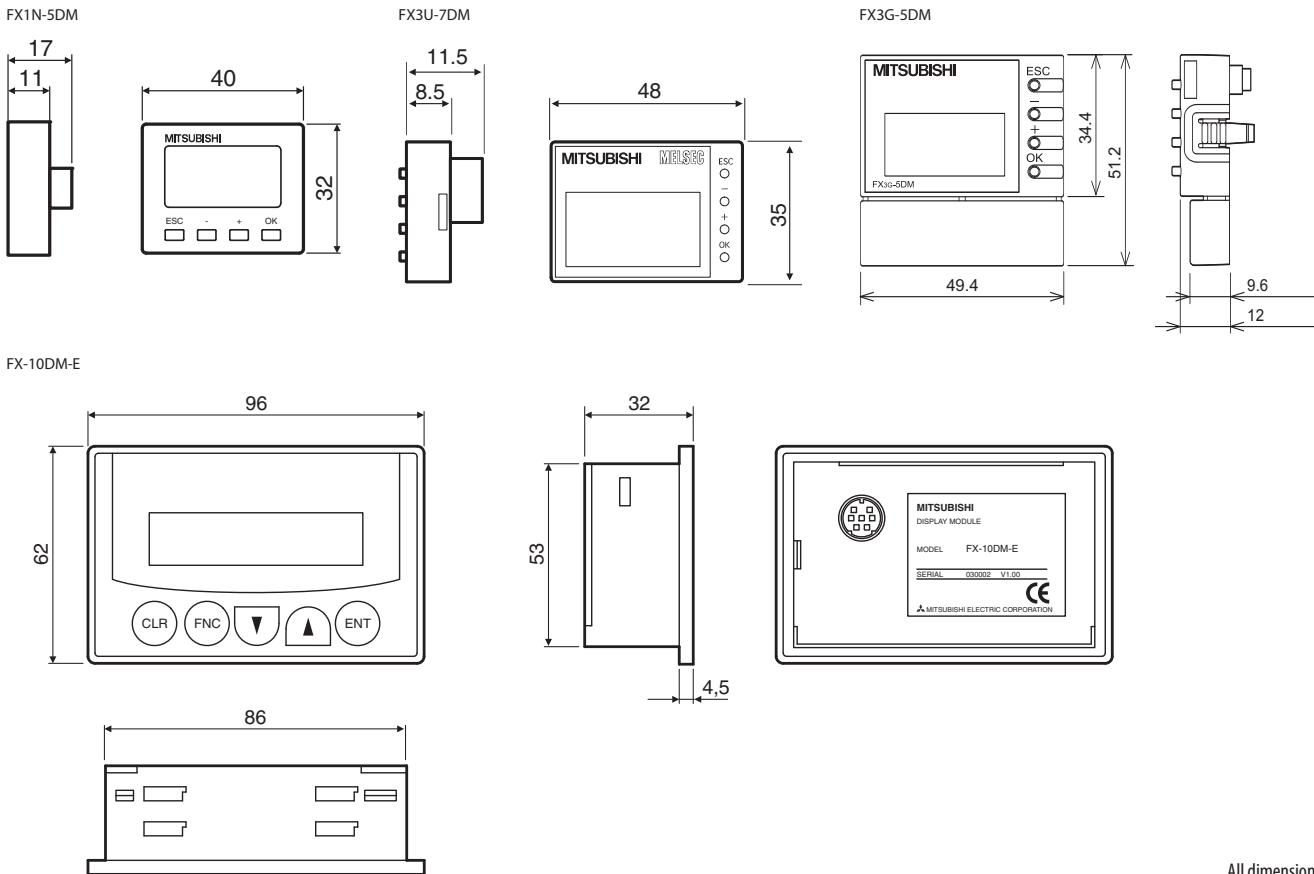

All dimensions in mm



**MELSOFT – Programming and Documentation Software for Standard Personal Computers**



With the MELSOFT software family Mitsubishi Electric offers efficient software packages helping to reduce programming and setup times to a high degree. The MELSOFT software family provides instant access, direct communications, compatibility, and open exchange of variables.

The MELSOFT family comprises:

- Programming packages AL-PCS/WIN and GX Developer
- Various development software for operator terminals (please refer to the GOT Technical Catalogue)
- Software for a dynamic data exchange like MX Change

AL-PCS/WIN is recommended as a cost-effective beginners package for the ALPHA series. This package offers a quick and easy introduction to programming.

GX Developer is the right decision for a universal programming package. In addition, GX Developer is fully compatible with all MELSEC PLCs, including A and Q series controllers.

For detailed information please order our separate MELSOFT brochure.

For structured programming the IEC1131.3 (EN 61131-3) conform programming software GX IEC Developer is recommended.

**ALPHA Programming Software**

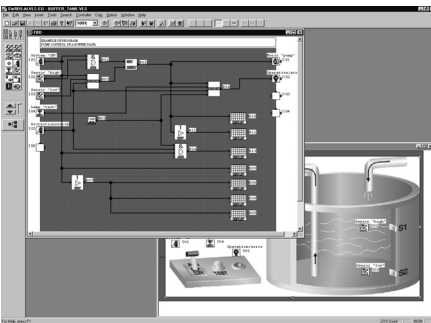

**AL-PCS/WIN Programming Software**

All controllers of the ALPHA series can be programmed with the MS Windows software AL-PCS/WIN. Programming the ALPHA with this software is very easy and is done by placing the different program elements on a graphical programming environment. The connections (wiring) between the inputs, function blocks, and outputs are drawn graphically by mouse click to build the logic. By this, programs with up to 200 function blocks can be created, where each single function in a program can be used as many times as desired. A complete documentation of the program can be created directly from AL-PCS/WIN.

Software	AL-PCS/WIN	
Series	Alpha series	
Language	7 languages (English/German/French/Italian/Spanish/Swedish/Russian)	
Applicable for	Windows 95/98/ME/NT/2000/XP/Vista	
<b>Order information</b>	Art. no.	152603

**PLC Training Software**

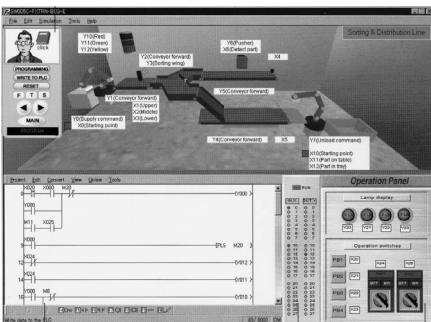

**FX-TRN-BEG-E Training Software**

The FX-TRN-BEG-E training software package is designed to help beginners get started with the programming of PLC systems. It combines a simulated PLC environment with expert tutorials. A real-time module simulates the operation of the PLC program. Simulation speed is adjustable and you can also access system elements and display program status while the process is running.

Software	FX-TRN-BEG-E	
Series	Whole FX family	
Language	English, Russian	
Applicable for	Windows 95/98/ME/NT/2000/XP/Vista	
<b>Order information</b>	Art. no.	149714

## PLC Programming Software

### ■ GX Developer

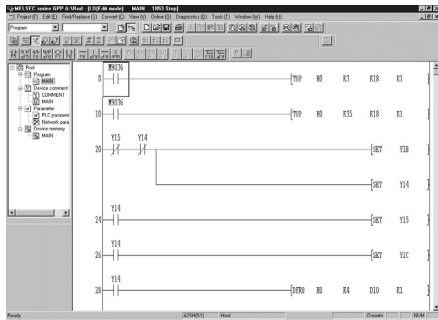

GX Developer is the standard programming software for all MELSEC PLC series and combines all functions of MELSEC MEDOC with the user guidance of Microsoft Windows.

With this software you can comfortably create PLC programs alternatively in the form of Ladder Diagrams or Instruction Lists. Both forms of representation can be toggled easily during operation.

Besides efficient monitoring and diagnostics functions GX Developer features an offline simulation of any PLC type.

With GX Developer all MELSEC PLCs from the FX1s to the Q25PH (Q series) are supported.

The GX Developer FX is limited to the programming of the FX series.

This software provides all the Windows-specific advantages and is especially suited to all MELSEC PLCs.

The software is supplied without an SC-09 programming cable, which can be ordered separately. This cable is needed for the connection between the PLC and a serial interface of a personal computer.

GX Developer can be run under MS Windows® XP and Vista.

Software	GX DEVELOPER FX V0878-1LOC-M	GX DEVELOPER FX V0878-2LOC-M_2&MORE	GX Developer V0800-1LOC-G	GX Developer V0800-1LOC-E
Series	FX1S, FX1N, FX3G, FX3U, FX3UC	FX1S, FX1N, FX3G, FX3U, FX3UC	All MELSEC PLCs	All MELSEC PLCs
Language	German/English	German/English	German	English
Disk type	CD ROM	CD ROM	CD ROM	CD ROM
<b>Order information</b>	Art. no. 225141	225155	152816	150420
<b>Accessory</b>	Programming cable SC-09, art. no.: 43393			

### ■ GX IEC Developer

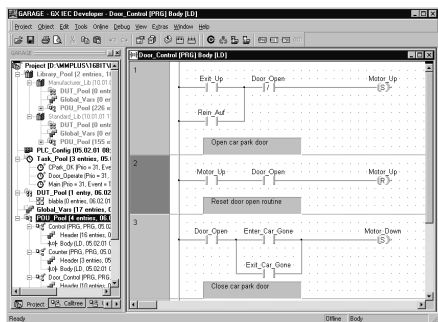

GX IEC Developer provides all functions of the pre-mentioned programs and in addition meets the programming standard: IEC 1131.3 (EN 61131). This makes the software ready for the programming standard of the future and offers beside the FX version in addition the full version as a basis for the on-leading programming of the MELSEC AnS/QnAS series, the

MELSEC AnU/QnA series and MELSEC System Q.

GX IEC Developer can be run under Windows 95/98 and Windows NT/2000/XP.

The software is supplied without an SC-09 programming cable, which can be ordered separately. This cable is needed for the connection between the PLC and a serial interface of a personal computer.

Software	GX IEC Developer FX V0703-1LOC-G	GX IEC Developer FX V0703-1LOC-E	GX IEC Developer V0703-1LOC-G	GX IEC Developer V0703-1LOC-E
Series	FX1S, FX1N, FX3G, FX3U, FX3UC	FX1S, FX1N, FX3G, FX3U, FX3UC	All MELSEC PLCs	All MELSEC PLCs
Language	German	English	German	English
Disk type	CD ROM	CD ROM	CD ROM	CD ROM
<b>Order information</b>	Art. no. 221425	221430	221413	221419
<b>Accessory</b>	Programming cable SC-09, art. no.: 43393			

## Configurations Software

### ■ GX Configurator DP

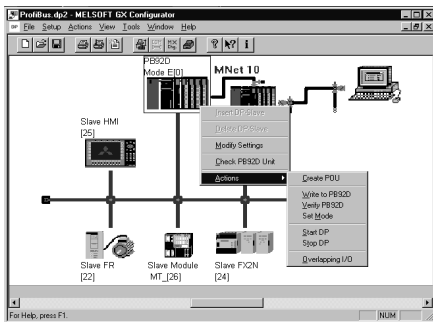

The GX Configurator DP is a user friendly configurations software for the open network PROFIBUS/DP.

The software package is a 32 bit application and runs under all Windows versions. Configuration of all PROFIBUS/DP modules for the MELSEC Ans/QnAS and A/Q series and also the FX family is possible.

Due to the supported extended user parameters of a GSD file, easy parameter setting of PROFIBUS/DP slave devices is possible even for third-party devices.

The new GX Configurator DP enables the download of all configuration data via an over-riding network.

All PROFIBUS modules are configured via the backside bus.

Software	GX Configurator DP V0500-1L0C-E	
Supported PROFIBUS/DP master modules for the Mitsubishi MELSEC series	A1S1J71PB92D, AJ71PB92D, QJ71PB92D	
Language	English/German	
Disk type	CD ROM	
<b>Order information</b>	Art. no.	145312
<b>Accessory</b>	Programming cable SC-09, art. no.: 43393	

### ■ FX Configurator FP

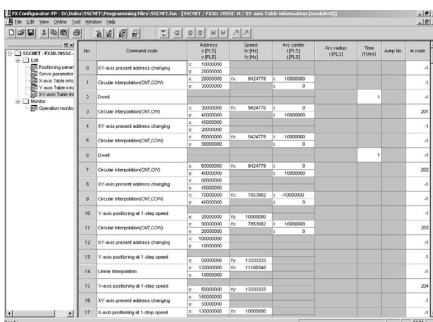

FX Configurator-FP is beneficial for setting up table operation information, servo amplifier parameters and positioning parameters for the FX3U-SSC-H positioning module. Positioning operations and their associated parameters (speeds, addresses, torque limits etc.) can be monitored and tested with the integrated monitor and test functions.

Control patterns from simple to complicated combinations of positioning commands can easily be configured with new methods.

The software runs under all Windows versions.

Software	FX Configurator FP V0100-1L0C-E	
Supported modules for the Mitsubishi MELSEC series	FX3U-20SSC-H	
Language	English	
Disk type	CD ROM	
<b>Order information</b>	Art. no.	189283
<b>Accessory</b>	Programming cable SC-09, art. no.: 43393	

**Hand-Held Programming Unit**



**FX-30P**

The FX-30P is a small, industrial programming and maintenance tool for the FX Series. This unit can perform program uploads/downloads and store up to 15 programs in its internal memory. Keywords can be registered, deleted or canceled in applicable PLCs. Program monitoring and data device adjustment functionality is also available. To stay up to date the latest firmware can be downloaded on a PC then installed via the USB port. PLC programs on the PC can also be transferred via USB, eliminating the need for peripheral devices.

*Note: FX-30P firmware and program downloads from a PC via the embedded USB port available in firmware versions 1.10 and later.*

Specifications		FX-30P
Applicable for		Base units FX1S, FX1N, FX3G, FX2N, FX3U, FX3UC
Ambient temperature		0–40 °C
Ambient relative humidity (non-condensing)		5–95 %
Power supply		5V DC ±5%/155 mA (from main unit)
Display		LCD (with backlight)
Character display		21x8
Keyboard		35
Memory	Program capacity	Built-in RAM: 64K steps for program monitoring and modification RAM retention (for about five years, ambient temperature 25 C(77 F)) by battery. Built-in flash memory ROM: Up to 15 programs can be stored in the built-in flash memory ROM. Allowable number of writes: 100,000 times
	HPP held data	Display language setting (Japanese, English or Chinese), contrast, buzzer sound volume, brightness adjustment, screen saver and HPP protect key (saved in the built-in flash memory)
Cable		FX-20P-CAB0
Weight	kg	0.3
Dimensions (WxHxD)	mm	87x170x30
<b>Order information</b>		Art. no. 221271



Module type	CE		uL cUL	Ship approvals					
	EMC	LVD		ABS	DNV	LR	GL	BV	RINA
<b>FX2NC Special Function Modules</b>									
FX2NC-485ADP	●	—	—	—	●	●	—	—	—
FX2NC-232ADP	●	—	—	—	●	●	—	—	—
FX2NC-ENET-ADP	●	○	●	—	—	—	—	—	—
FX2NC-1HC	●	○	●	—	—	—	—	—	—
<b>FX3U Special Function Modules</b>									
FX3U-2HC	●	○	●	—	—	—	—	—	—
FX3U-3A-ADP	●	○	●	—	—	—	—	—	—
FX3U-4AD	●	○	●	—	—	—	—	—	—
FX3U-4DA	●	○	●	—	—	—	—	—	—
FX3U-4AD-TC-ADP	●	○	●	●	●	●	●	●	●
FX3U-4AD-PT-ADP	●	○	●	●	●	●	●	●	●
FX3U-4AD-PNK-ADP	●	○	●	—	—	—	—	—	—
FX3U-4AD-Ptw-ADP	●	○	●	—	—	—	—	—	—
FX3U-4AD-ADP	●	○	●	●	●	●	●	●	●
FX3U-4DA-ADP	●	○	●	●	●	●	●	●	●
FX3U-4HSX-ADP	●	○	●	●	●	●	●	●	●
FX3U-4LC	●	○	●	—	—	—	—	—	—
FX3U-CF-ADP	●	○	●	—	—	—	—	—	—
FX3U-2HSY-ADP	●	○	●	●	●	●	●	●	●
FX3U-20SSC-H	●	○	●	—	—	—	—	—	—
FX3U-485ADP-MB	●	○	●	—	—	—	●	●	—
FX3U-232ADP-MB	●	○	●	—	—	—	●	●	—
FX3U-ENET	●	○	●	—	—	—	—	—	—
FX3U-64DP-M	●	○	●	—	—	—	—	—	—
FX3U-64CCL	●	—	●	—	—	—	—	—	—
<b>Adapter Boards</b>									
FX1N-1DA-BD	●	○	—	●	●	●	●	—	●
FX1N-2AD-BD	●	○	—	●	●	●	●	—	●
FX1N-2EYT-BD	●	○	—	●	●	●	●	—	●
FX1N-4EX-BD	●	○	—	●	●	●	●	—	●
FX1N-8AV-BD	●	○	—	●	●	●	●	—	●
FX1N-232-BD	●	○	—	●	—	●	●	—	●
FX1N-422-BD	●	○	—	●	—	●	●	—	●
FX1N-485-BD	●	○	—	●	—	●	●	—	●
FX1N-CNV-BD	●	○	—	●	●	●	—	—	—
FX2N-8AV-BD	●	○	—	●	—	—	—	—	—
FX2N-232-BD	●	○	—	●	—	—	—	—	—
FX2N-422-BD	●	○	—	●	—	—	—	—	—
FX2N-485-BD	●	○	—	●	—	—	—	—	—
FX2N-CNV-BD	●	○	—	—	—	—	—	—	—
FX3G-1DA-BD	●	○	—	—	—	—	—	—	—
FX3G-2AD-BD	●	○	—	—	—	—	—	—	—
FX3G-8AV-BD	●	○	—	—	—	—	—	—	—
FX3G-232-BD	●	○	—	—	—	—	—	—	—
FX3G-422-BD	●	○	—	—	—	—	—	—	—
FX3G-485-BD	●	○	—	—	—	—	—	—	—
FX3U-232-BD	●	○	—	●	●	●	●	●	●
FX3U-422-BD	●	○	—	●	●	●	●	●	●
FX3U-485-BD	●	○	—	●	●	●	●	●	●
FX3U-CNV-BD	●	○	—	●	●	●	●	●	●
FX3U-USB-BD	●	○	—	●	●	●	●	●	●

Module type	CE		uL cUL	Ship approvals					
	EMC	LVD		ABS	DNV	LR	GL	BV	RINA
<b>Terminal Blocks</b>									
TB-205	—	○	●	—	—	—	—	—	—
TB-20C	—	○	●	—	—	—	—	—	—
<b>Accessories</b>									
ALPHA POWER 24	●	●	●	—	—	—	—	—	—
FX1N-5DM	●	○	—	●	●	●	●	—	●
FX-10DM-E	●	○	—	—	—	—	—	—	—
FX-20 P-E-SET0	●	○	—	—	—	—	—	—	—
FX-USB-AW	●	○	—	—	—	—	—	—	—
FX-232AWC-H	●	○	—	—	—	—	—	—	—
FX2N-CNV-IF	●	○	—	●	—	—	—	—	—
FX2N-CNV-BC	●	○	—	—	—	—	—	—	—
FX2N-CNV-IF	●	○	—	—	●	●	—	—	—
FX3U-1PSU-5V	—	—	—	—	—	—	—	—	—
FX3UC-1PS-5V	—	—	—	—	●	—	—	—	—
FX3U-7DM	●	○	—	●	●	●	●	●	●
FX3U-7DM-HLD	●	—	—	—	—	—	—	—	—

● = comply, ○ = no need to comply

- A**  
AL-232CAB . . . . . 12  
AL2-10MR-A . . . . . 9  
AL2-10MR-D . . . . . 9  
AL2-14MR-A . . . . . 9  
AL2-14MR-D . . . . . 9  
AL2-24MR-A . . . . . 9  
AL2-24MR-D . . . . . 9  
AL2-2DA . . . . . 11  
AL2-2PT-ADP . . . . . 11  
AL2-2TC-ADP . . . . . 11  
AL2-4EX . . . . . 11  
AL2-4EX-A2 . . . . . 11  
AL2-4EYR . . . . . 11  
AL2-4EYT . . . . . 11  
AL2-ASI-BD . . . . . 12  
AL2-EEPROM-2 . . . . . 12  
AL2-GSM-CAB . . . . . 12  
ALPHA 2 series  
Accessories . . . . . 12  
Base units . . . . . 9  
Dimensions . . . . . 56  
Extension modules . . . . . 11  
Interface Cable . . . . . 12  
Memory Cassette . . . . . 12  
Specifications . . . . . 10  
System description . . . . . 8  
ALPHA POWER 24-0.75 . . . . . 53  
ALPHA POWER 24-1.75 . . . . . 53  
ALPHA POWER 24-2.5 . . . . . 53  
Accessories  
Batteries . . . . . 53  
Cables . . . . . 52  
Connection terminals . . . . . 52  
Display modules . . . . . 55  
Programming Cables . . . . . 54  
Terminal blocks . . . . . 51  
Active data modules . . . . . 45  
Adapter boards . . . . . 47  
Analog modules . . . . . 33  
Dimensions . . . . . 60
- C**  
Cables . . . . . 54  
Connection Cable . . . . . 52  
Modules . . . . . 54  
Terminal blocks . . . . . 52
- D**  
Data logger module . . . . . 36  
Dimensions . . . . . 56  
Display Modules . . . . . 55
- E**  
Extension Adapter Boards . . . . . 46  
Extensions  
ALPHA 2 Series . . . . . 11  
Dimensions . . . . . 59  
FX series . . . . . 26  
External Terminal Blocks . . . . . 51
- F**  
F2-232CAB-1 . . . . . 54  
F2-RS-5CAB . . . . . 54  
FX Configurator FP . . . . . 65  
FX-10DM-E . . . . . 55  
FX-20P-CAB . . . . . 54  
FX-20P-CAB0 . . . . . 54  
FX-20P-CADP . . . . . 54  
FX-232AWC-H . . . . . 54  
FX-232CAB-1 . . . . . 54  
FX-422CAB . . . . . 54  
FX-422CAB-150 . . . . . 54  
FX-422CAB0 . . . . . 54  
FX-USB-AW . . . . . 54  
FXON-32NT-DP . . . . . 42  
FXON-3A . . . . . 34  
FXON-40ER-DS . . . . . 29  
FXON-40ER-ES/UL . . . . . 29  
FXON-40ET-DSS . . . . . 29  
FXON-65EC . . . . . 54  
FX1N series  
Base units . . . . . 17  
Specifications . . . . . 18  
System description . . . . . 16  
FX1N-14MR-DS . . . . . 17  
FX1N-14MR-ES/UL . . . . . 17  
FX1N-14MT-DSS . . . . . 17  
FX1N-1DA-BD . . . . . 47  
FX1N-232-BD . . . . . 49  
FX1N-24MR-DS . . . . . 17  
FX1N-24MR-ES/UL . . . . . 17  
FX1N-24MT-DSS . . . . . 17  
FX1N-2AD-BD . . . . . 47  
FX1N-2EYT-BD . . . . . 46  
FX1N-40MR-DS . . . . . 17  
FX1N-40MR-ES/UL . . . . . 17  
FX1N-40MT-DSS . . . . . 17  
FX1N-422-BD . . . . . 49  
FX1N-485-BD . . . . . 49  
FX1N-4EX-BD . . . . . 46  
FX1N-5DM . . . . . 55  
FX1N-60MR-DS . . . . . 17  
FX1N-60MR-ES/UL . . . . . 17  
FX1N-60MT-DSS . . . . . 17  
FX1N-8AV-BD . . . . . 48  
FX1N-CNV-BD . . . . . 48  
FX1N-EEPROM-8L . . . . . 50  
FX1S series  
Base units . . . . . 14  
Specifications . . . . . 15  
System description . . . . . 13  
FX1S-10MR-DS . . . . . 14  
FX1S-10MR-ES/UL . . . . . 14  
FX1S-10MT-DSS . . . . . 14  
FX1S-14MR-DS . . . . . 14  
FX1S-14MR-ES/UL . . . . . 14  
FX1S-14MT-DSS . . . . . 14  
FX1S-20MR-DS . . . . . 14  
FX1S-20MR-ES/UL . . . . . 14  
FX1S-20MT-DSS . . . . . 14  
FX1S-30MR-DS . . . . . 14  
FX1S-30MR-ES/UL . . . . . 14  
FX1S-30MT-DSS . . . . . 14  
FX2N-10PG . . . . . 38  
FX2N-16CCL-M . . . . . 39  
FX2N-16EX-ES/UL . . . . . 31  
FX2N-16EYR-ES/UL . . . . . 31  
FX2N-16EYT-ESS/UL . . . . . 31  
FX2N-1HC . . . . . 37  
FX2N-1PG-E . . . . . 38  
FX2N-232IF . . . . . 46  
FX2N-2AD . . . . . 33  
FX2N-2DA . . . . . 33  
FX2N-2LC . . . . . 34  
FX2N-32ASI-M . . . . . 40  
FX2N-32CAN . . . . . 44  
FX2N-32CCL . . . . . 40  
FX2N-32DP-IF . . . . . 43  
FX2N-32DP-IF-D . . . . . 43  
FX2N-32ER-ES/UL . . . . . 30  
FX2N-32ET-ESS/UL . . . . . 30  
FX2N-48ER-DS . . . . . 30  
FX2N-48ER-ES/UL . . . . . 30  
FX2N-48ET-DSS . . . . . 30  
FX2N-48ET-ESS/UL . . . . . 30  
FX2N-4AD . . . . . 33  
FX2N-4AD-PT . . . . . 34  
FX2N-4AD-TC . . . . . 34  
FX2N-4DA . . . . . 33  
FX2N-5A . . . . . 34  
FX2N-64DNET . . . . . 44  
FX2N-8AD . . . . . 33  
FX2N-8ER-ES/UL . . . . . 31  
FX2N-8EX-ES/UL . . . . . 31  
FX2N-8EYR-ES/UL . . . . . 31  
FX2N-8EYT-ESS/UL . . . . . 31  
FX2NC-16EX-DS . . . . . 32  
FX2NC-16EX-T-DS . . . . . 32  
FX2NC-16EYR-T-DS . . . . . 32  
FX2NC-16EYT-DSS . . . . . 32  
FX2NC-1HC . . . . . 37  
FX2NC-232ADP . . . . . 45  
FX2NC-32BL . . . . . 53  
FX2NC-32EX-DS . . . . . 32  
FX2NC-32EYT-DSS . . . . . 32  
FX2NC-485ADP . . . . . 45  
FX2NC-CNV-IF . . . . . 50  
FX2NC-ENET-ADP . . . . . 41  
FX3G series  
Base units . . . . . 20  
Specifications . . . . . 21  
System description . . . . . 19  
FX3G-14MR/DS . . . . . 20  
FX3G-14MR/ES . . . . . 20  
FX3G-14MT/DSS . . . . . 20  
FX3G-14MT/ESS . . . . . 20  
FX3G-1DA-BD . . . . . 47  
FX3G-232-BD . . . . . 49  
FX3G-24MR/DS . . . . . 20  
FX3G-24MR/ES . . . . . 20  
FX3G-24MT/DSS . . . . . 20  
FX3G-24MT/ESS . . . . . 20  
FX3G-2AD-BD . . . . . 47  
FX3G-40MR/DS . . . . . 20  
FX3G-40MR/ES . . . . . 20  
FX3G-40MT/DSS . . . . . 20  
FX3G-40MT/ESS . . . . . 20  
FX3G-422-BD . . . . . 49  
FX3G-485-BD . . . . . 49  
FX3G-5DM . . . . . 55  
FX3G-60MR/DS . . . . . 20  
FX3G-60MR/ES . . . . . 20  
FX3G-60MT/DSS . . . . . 20  
FX3G-60MT/ESS . . . . . 20  
FX3G-8AV-BD . . . . . 48  
FX3G-CNV-ADP . . . . . 48  
FX3G-EEPROM-32L . . . . . 50  
FX3U series  
Base units . . . . . 23  
Specifications . . . . . 25  
System description . . . . . 22  
FX3U-128MR/ES . . . . . 24  
FX3U-128MT/ESS . . . . . 24  
FX3U-16MR/DS . . . . . 23  
FX3U-16MR/ES . . . . . 23  
FX3U-16MT/DSS . . . . . 23  
FX3U-16MT/ESS . . . . . 23  
FX3U-1PSU-5V . . . . . 53  
FX3U-20SSC-H . . . . . 38  
FX3U-232-BD . . . . . 49  
FX3U-232ADP . . . . . 45  
FX3U-2HC . . . . . 37  
FX3U-2HSY-ADP . . . . . 37  
FX3U-32BL . . . . . 53  
FX3U-32DP . . . . . 43  
FX3U-32MR/DS . . . . . 23  
FX3U-32MR/ES . . . . . 23  
FX3U-32MT/DSS . . . . . 23  
FX3U-32MT/ESS . . . . . 23  
FX3U-3A-ADP . . . . . 34  
FX3U-422-BD . . . . . 49  
FX3U-485-BD . . . . . 49  
FX3U-485ADP-MB . . . . . 45  
FX3U-48MR/DS . . . . . 24  
FX3U-48MR/ES . . . . . 24  
FX3U-48MT/DSS . . . . . 24  
FX3U-48MT/ESS . . . . . 24  
FX3U-4AD . . . . . 33  
FX3U-4AD-ADP . . . . . 35  
FX3U-4AD-PNK-ADP . . . . . 35  
FX3U-4AD-PT-ADP . . . . . 35  
FX3U-4AD-PTW-ADP . . . . . 35  
FX3U-4AD-TC-ADP . . . . . 35  
FX3U-4DA . . . . . 33  
FX3U-4DA-ADP . . . . . 35  
FX3U-4HSX-ADP . . . . . 37  
FX3U-4LC . . . . . 36  
FX3U-64CCL . . . . . 39  
FX3U-64DP-M . . . . . 42  
FX3U-64MR/DS . . . . . 24  
FX3U-64MR/ES . . . . . 24  
FX3U-64MT/DSS . . . . . 24  
FX3U-64MT/ESS . . . . . 24  
FX3U-7DM . . . . . 55  
FX3U-7DM-HLD . . . . . 55  
FX3U-80MR/DS . . . . . 24  
FX3U-80MR/ES . . . . . 24  
FX3U-80MT/DSS . . . . . 24  
FX3U-80MT/ESS . . . . . 24  
FX3U-CF-ADP . . . . . 36  
FX3U-CNV-BD . . . . . 48  
FX3U-ENET . . . . . 41  
FX3U-FLROM-16 . . . . . 50  
FX3U-FLROM-64 . . . . . 50  
FX3U-FLROM-64L . . . . . 50  
FX3U-USB-BD . . . . . 48  
FX3UC-16MT/DSS . . . . . 27  
FX3UC-1PS-5V . . . . . 53  
FX3UC-32MT/DSS . . . . . 27  
FX3UC-4AD . . . . . 33  
FX3UC-64MT/DSS . . . . . 27  
FX3UC-96MT/DSS . . . . . 27  
FX3UC-Series  
Base Units . . . . . 27  
Specifications . . . . . 28  
System description . . . . . 26
- G**  
GX Configurator DP . . . . . 65  
GX Developer . . . . . 64  
GX IEC Developer . . . . . 64
- H**  
High speed counter . . . . . 37
- I**  
Interface Adapters . . . . . 49  
Interface modules . . . . . 45
- M**  
Memory Media . . . . . 12, 50
- N**  
Network modules . . . . . 39
- P**  
Positioning modules . . . . . 38  
Power supply units  
24 V . . . . . 53  
5 V . . . . . 53
- S**  
SC-09 . . . . . 54  
Sample Calculations . . . . . 7  
Ship approvals . . . . . 67  
Software  
AL-PCS/WIN . . . . . 63  
FX Configurator FP V0100-1LOC-E . . . . . 65  
FX-TRN-BEG-E . . . . . 63  
GX Configurator DP V0500-1LOC-E . . . . . 65  
GX DEVELOPER FX V0878-1LOC-M . . . . . 64  
GX DEVELOPER FX V0878-2LOC-M\_28MORE . . . . . 64  
GX Developer V0800-1LOC-E . . . . . 64  
GX Developer V0800-1LOC-G . . . . . 64  
Specifications  
ALPHA 2 . . . . . 9  
FX1N series . . . . . 18  
FX1S series . . . . . 15  
FX3G . . . . . 21  
FX3U series . . . . . 25  
FX3UC series . . . . . 28  
System description  
ALPHA 2 series . . . . . 8  
FX1N series . . . . . 16  
FX1S series . . . . . 13  
FX3G Series . . . . . 19  
FX3U series . . . . . 22  
FX3UC series . . . . . 26  
MELSEC PLC Systems . . . . . 4
- T**  
TB-16EX-C . . . . . 51  
TB-16EX-S . . . . . 51  
TB-20-S . . . . . 51  
TB-20C . . . . . 51  
TB-8EX-C . . . . . 51  
TB-8EX-S . . . . . 51  
TB-8EY-C . . . . . 51  
TB-8EY-S . . . . . 51  
TB-8RELAY-6A . . . . . 51  
TB-8TRANSISTOR-2A . . . . . 51  
TB-CON-5-C . . . . . 52  
TB-CON10-C . . . . . 52  
TB-EX-CAB-1M . . . . . 52  
TB-EX-CAB-3M . . . . . 52  
TB-EX-CAB-5M . . . . . 52  
TB-EY-CAB-1M . . . . . 52  
TB-EY-CAB-3M . . . . . 52  
TB-EY-CAB-5M . . . . . 52  
Temperature control module . . . . . 36





# A world of automation solutions

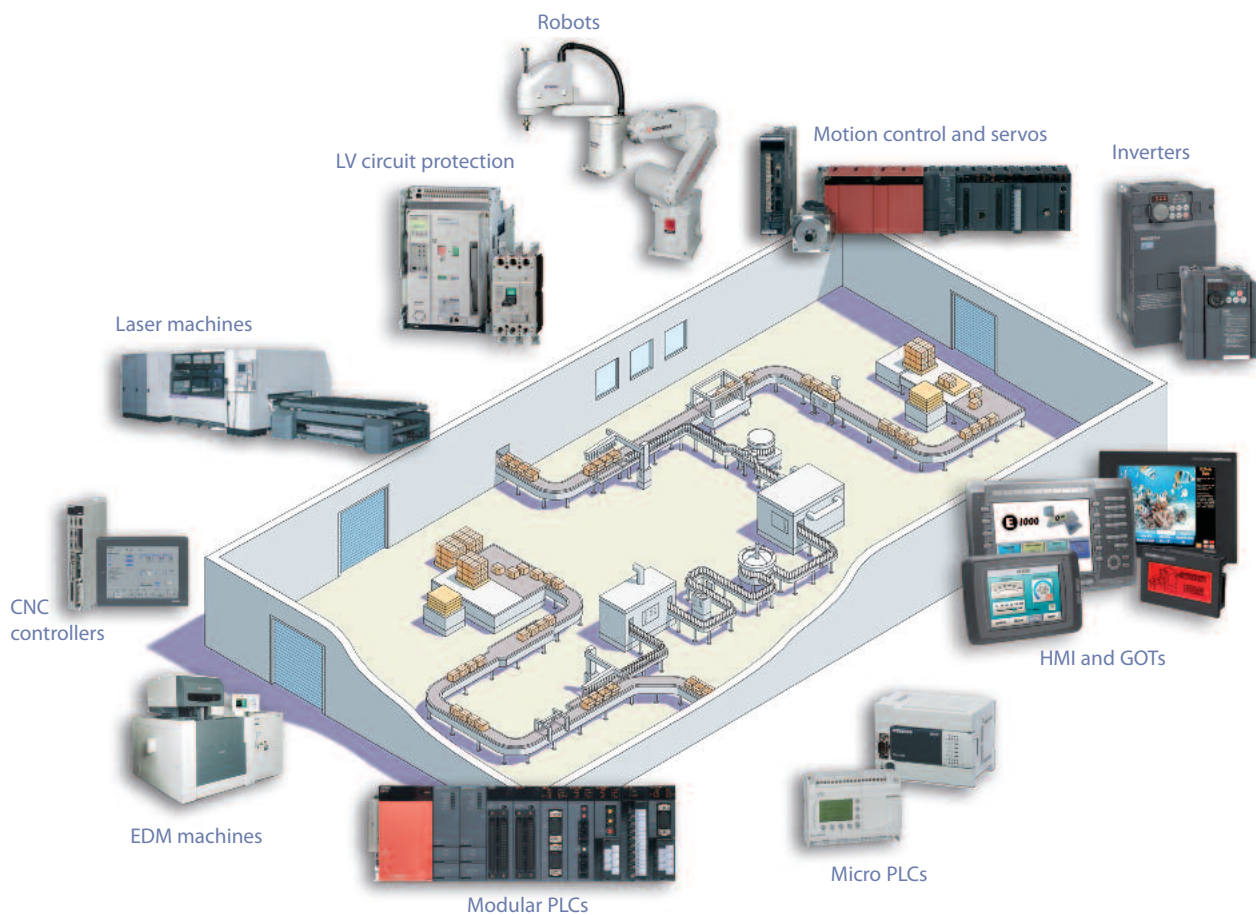

Mitsubishi offer a wide range of automation equipment from PLCs and HMIs to CNC and EDM machines.

## A name to trust

Since its beginnings in 1870, some 45 companies use the Mitsubishi name, covering a spectrum of finance, commerce and industry.

The Mitsubishi brand name is recognized around the world as a symbol of premium quality.

Mitsubishi Electric Corporation is active in space development, transportation, semiconductors, energy systems, communications and information processing, audio visual equipment, home electronics, building and energy management and automation systems, and has 237 factories and laboratories worldwide in over 121 countries.

This is why you can rely on a Mitsubishi automation solution – because we know first hand about the need for reliable, efficient, easy-to-use automation and control in our own factories.

As one of the world's leading companies with a global turnover of over 4 trillion Yen (over \$40 billion), employing over 100,000 people, Mitsubishi Electric has the resource and the commitment to deliver the ultimate in service and support as well as the best products.

# Global Partner. Local Friend.

## EUROPEAN BRANCHES

MITSUBISHI ELECTRIC EUROPE B.V. **GERMANY**  
Gothaer Straße 8  
**D-40880 Ratingen**  
Phone: +49 (0)2102 / 486-0

MITSUBISHI ELECTRIC EUROPE B.V. **CZECH REPUBLIC**  
Radlická 714/113a  
**CZ-158 00 Praha 5**  
Phone: +420 - 251 551 470

MITSUBISHI ELECTRIC EUROPE B.V. **FRANCE**  
25, Boulevard des Bouvets  
**F-92741 Nanterre Cedex**  
Phone: +33 (0)1 / 55 68 55 68

MITSUBISHI ELECTRIC EUROPE B.V. **ITALY**  
Viale Colleoni 7  
**I-20041 Agrate Brianza (MB)**  
Phone: +39 039 / 60 53 1

MITSUBISHI ELECTRIC EUROPE B.V. **POLAND**  
Krakowska 50  
**PL-32-083 Balice**  
Phone: +48 (0)12 / 630 47 00

MITSUBISHI ELECTRIC EUROPE B.V. **SPAIN**  
Carretera de Rubí 76-80  
**E-08190 Sant Cugat del Vallés (Barcelona)**  
Phone: 902 131121 // +34 935653131

MITSUBISHI ELECTRIC EUROPE B.V. **UK**  
Travellers Lane  
**UK-Hatfield, Herts. AL10 8XB**  
Phone: +44 (0)1707 / 27 61 00

## EUROPEAN REPRESENTATIVES

GEVA **AUSTRIA**  
Wiener Straße 89  
**AT-2500 Baden**  
Phone: +43 (0)2252 / 85 55 20

TEHNIKON **BELARUS**  
Oktyabrskaya 16/5, Of. 703-711  
**BY-220030 Minsk**  
Phone: +375 (0)17 / 210 46 26

ESCO D & A **BELGIUM**  
Culliganlaan 3  
**BE-1831 Diegem**  
Phone: +32 (0)2 / 717 64 30

Koning & Hartman b.v. **BELGIUM**  
Woluwelaan 31  
**BE-1800 Vilvoorde**  
Phone: +32 (0)2 / 257 02 40

INEA BH d.o.o. **BOSNIA AND HERZEG.**  
Aleja Lipa 56  
**BA-71000 Sarajevo**  
Phone: +387 (0)33 / 921 164

AKHNATON **BULGARIA**  
4 Andrej Ljapchev Blvd. Pb 21  
**BG-1756 Sofia**  
Phone: +359 (0)2 / 817 6004

INEA CR d.o.o. **CROATIA**  
Losinjska 4 a  
**HR-10000 Zagreb**  
Phone: +385 (0)1 / 36 940 - 01 / -02 / -03

AutoCont C.S. s.r.o. **CZECH REPUBLIC**  
Technologická 374/6  
**CZ-708 00 Ostrava-Pustkovec**  
Phone: +420 595 691 150

B-ELECTRIC, s.r.o. **CZECH REPUBLIC**  
Mladoboleslavská 812  
**CZ-197 00 Praha 19 - Kbely**  
Phone: +420 286 850 848

Beijer Electronics A/S **DENMARK**  
Lykkegårdsvej 17  
**DK-4000 Roskilde**  
Phone: +45 (0)46 / 75 76 66

Beijer Electronics Eesti OÜ **ESTONIA**  
Pärnu mnt. 160i  
**EE-11317 Tallinn**  
Phone: +372 (0)6 / 51 81 40

Beijer Electronics OY **FINLAND**  
Peltoie 37  
**FI-28400 Ulvila**  
Phone: +358 (0)207 / 463 540

UTECO A.B.E.E. **GREECE**  
5, Mavrogenous Str.  
**GR-18542 Piraeus**  
Phone: +30 211 / 1206 900

MELTRADE Ltd. **HUNGARY**  
Fertő utca 14.  
**HU-1107 Budapest**  
Phone: +36 (0)1 / 431-9726

KAZPROMAUTOM. Ltd. **KAZAKHSTAN**  
Mustafina Str. 7/2  
**KAZ-470046 Karaganda**  
Phone: +7 7212 / 50 11 50

Beijer Electronics SIA **LATVIA**  
Ritausmas iela 23  
**LV-1058 Riga**  
Phone: +371 (0)784 / 2280

Beijer Electronics UAB **LITHUANIA**  
Savanoriu Pr. 187  
**LT-02300 Vilnius**  
Phone: +370 (0)5 / 232 3101

ALFATRADE Ltd. **MALTA**  
99, Paola Hill  
**Malta- Paola PLA 1702**  
Phone: +356 (0)21 / 697 816

INTEHSIS srl **MOLDOVA**  
bld. Traian 23/1  
**MD-2060 Kishinev**  
Phone: +373 (0)22 / 66 4242

HIFLEX AUTOM. B.V. **NETHERLANDS**  
Wolweverstraat 22  
**NL-2984 CD Ridderkerk**  
Phone: +31 (0)180 - 46 60 04

Koning & Hartman b.v. **NETHERLANDS**  
Haarlerbergweg 21-23  
**NL-1101 CH Amsterdam**  
Phone: +31 (0)20 / 587 76 00

Beijer Electronics AS **NORWAY**  
Postboks 487  
**NO-3002 Drammen**  
Phone: +47 (0)32 / 24 30 00

Sirius Trading & Services **ROMANIA**  
Aleea Lacul Morii Nr. 3  
**RO-060841 Bucuresti, Sector 6**  
Phone: +40 (0)21 / 430 40 06

Craft Con. & Engineering d.o.o. **SERBIA**  
Bulevar Svetog Cara Konstantina 80-86  
**SER-18106 Nis**  
Phone: +381 (0)18 / 292-24-4/5

INEA SR d.o.o. **SERBIA**  
Izletnicka 10  
**SER-113000 Smederevo**  
Phone: +381 (0)26 / 617 163

AutoCont Control s.r.o. **SLOVAKIA**  
Radlinského 47  
**SK-02601 Dolny Kubin**  
Phone: +421 (0)43 / 5868210

CS Mirade Slovensko, s.r.o. **SLOVAKIA**  
Vajanskeho 58  
**SK-92101 Piestany**  
Phone: +421 (0)33 / 7742 760

INEA d.o.o. **SLOVENIA**  
Stegne 11  
**SI-1000 Ljubljana**  
Phone: +386 (0)1 / 513 8100

Beijer Electronics AB **SWEDEN**  
Box 426  
**SE-20124 Malmö**  
Phone: +46 (0)40 / 35 86 00

Omni Ray AG **SWITZERLAND**  
Im Schöri 5  
**CH-8600 Dübendorf**  
Phone: +41 (0)44 / 802 28 80

GTS **TURKEY**  
Bayraktar Bulvarı Nutuk Sok. No:5  
**TR-34775 Yukarı İSTANBUL**  
Phone: +90 (0)216 526 39 90

CSC Automation Ltd. **UKRAINE**  
4-B, M. Raskovoyi St.  
**UA-02660 Kiev**  
Phone: +380 (0)44 / 494 33 55

TEXEL ELECTRONICS Ltd. **ISRAEL**  
2 Ha'umanut, P.O.B. 6272  
**IL-42160 Netanya**  
Phone: +972 (0)9 / 863 39 80

CEG INTERNATIONAL **LEBANON**  
Cebaco Center/Block A Autostrade DORA  
**Lebanon - Beirut**  
Phone: +961 (0)1 / 240 430

CBI Ltd. **SOUTH AFRICA**  
Private Bag 2016  
**ZA-1600 Isando**  
Phone: +27 (0)11 / 977 0770



Mitsubishi Electric Europe B.V. /// FA - European Business Group /// Gothaer Straße 8 /// D-40880 Ratingen /// Germany  
Tel.: +49(0)2102 4860 /// Fax: +49(0)2102 4861120 /// info@mitsubishi-automation.com /// www.mitsubishi-automation.com

Specifications subject to change /// Art.-no. 167840-F /// 10.2010  
All trademarks and copyrights acknowledged.