

## STELLA-HB-WWW

~100° very wide beam for warehouse and outdoor lighting. Compatible with up to 30 mm LES size COBs. Variant with black frame.

### TECHNICAL SPECIFICATIONS:

Dimensions	Ø 90.0 mm
Height	11.3 mm
Fastening	screw
Ingress protection classes	IP67
ROHS compliant	yes ⓘ



### MATERIAL SPECIFICATIONS:

Component	Type	Material	Colour	Finish
STELLA-HB-WWW	Single lens	Silicone	clear	
STELLA-FRAME	Holder	PA66	black	

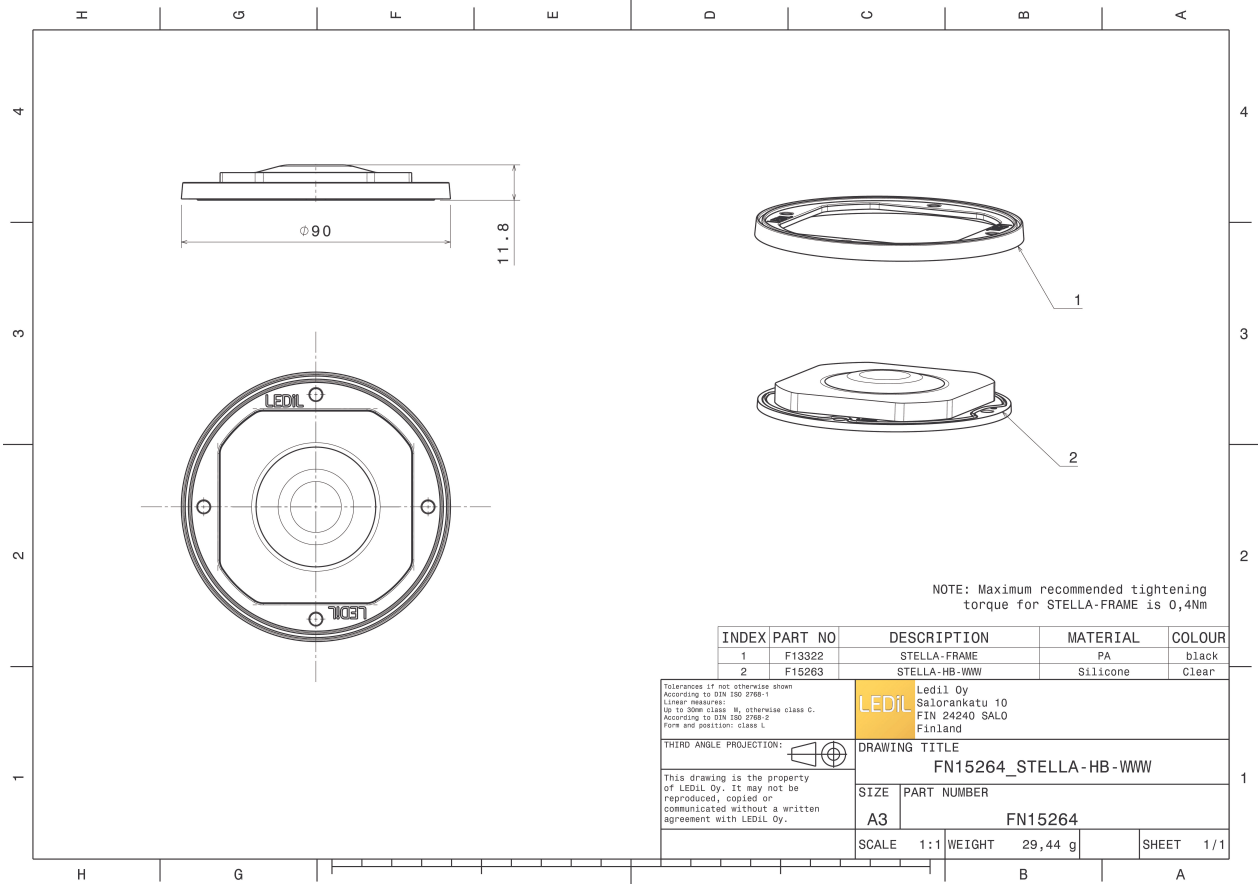

### ORDERING INFORMATION:

Component		Qty in box	MOQ	MPQ	Box weight (kg)
FN15264_STELLA-HB-WWW	Single lens	135	135	15	5.0
» Box size: 480 x 280 x 300 mm					

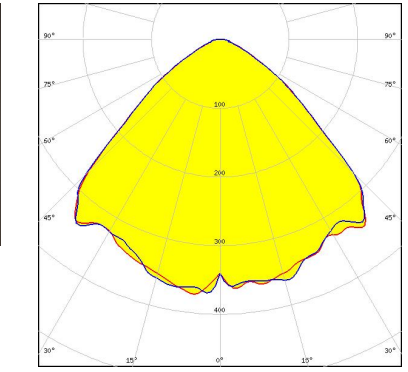
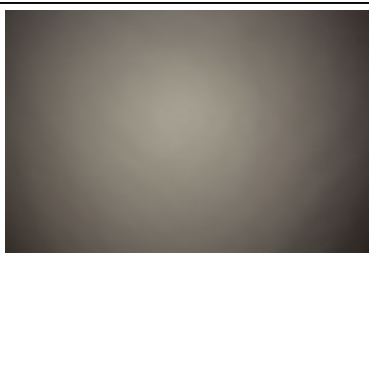
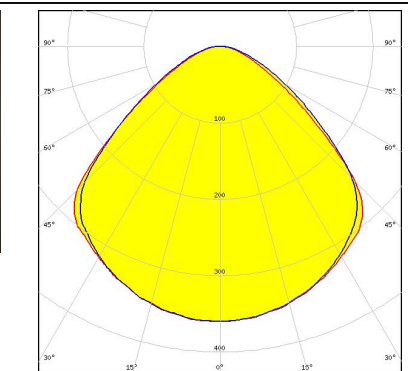
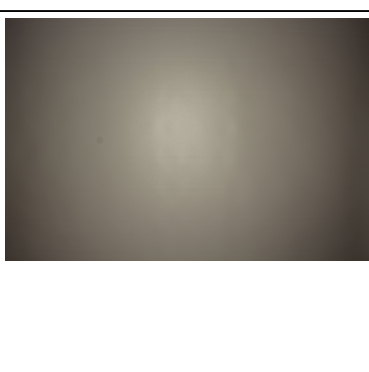
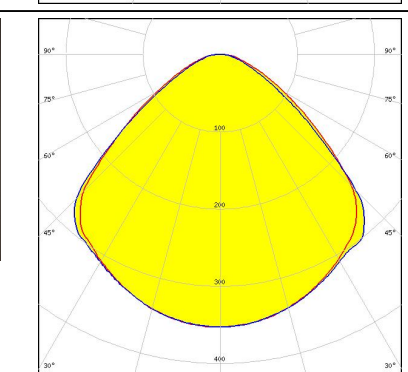

See also our general installation guide: [www.ledil.com/installation\\_guide](http://www.ledil.com/installation_guide)

#### PHOTOMETRIC DATA (MEASURED):

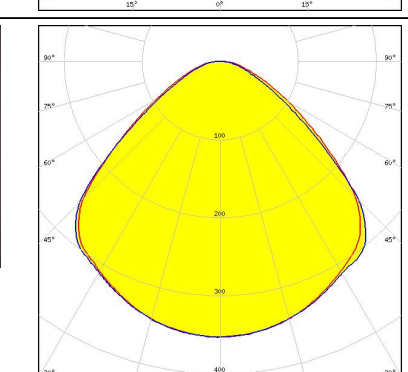

<p>bridgelux.</p> <p>LED V18 Gen7            FWHM 102.0°            Efficiency 87 %            Peak intensity 0.4 cd/lm            LEDs/each optic 1            Light colour White            Required components:            BJB: 47.319.2350</p>		
<p>bridgelux.</p> <p>LED V18 Gen7            FWHM 102.0°            Efficiency 90 %            Peak intensity 0.4 cd/lm            LEDs/each optic 1            Light colour White            Required components:            Bender Wirth: 439 Typ L3</p>		
<p>bridgelux.</p> <p>LED V18 Gen7            FWHM 101.0°            Efficiency 88 %            Peak intensity 0.4 cd/lm            LEDs/each optic 1            Light colour White            Required components:</p>		
<p>bridgelux.</p> <p>LED V22 Gen7            FWHM 102.0°            Efficiency 89 %            Peak intensity 0.4 cd/lm            LEDs/each optic 1            Light colour White            Required components:            Bender Wirth: 431 Typ Z1</p>		

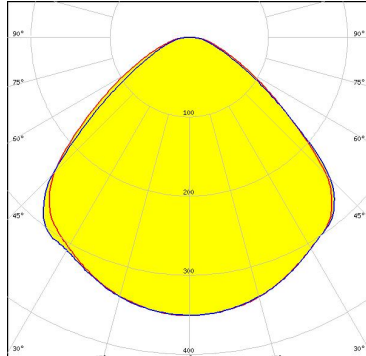
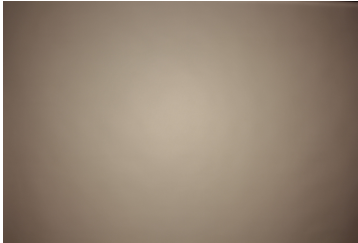
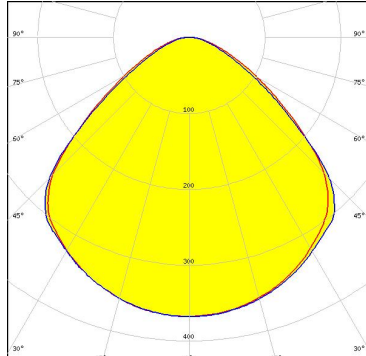
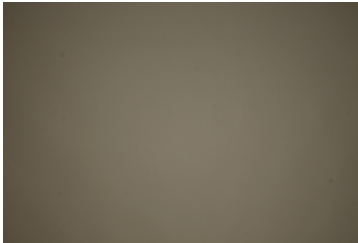
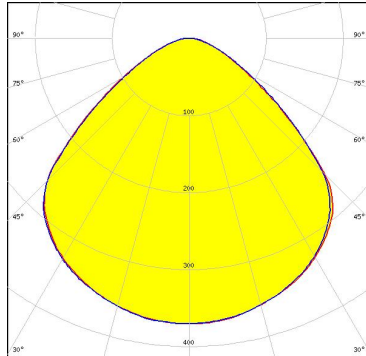
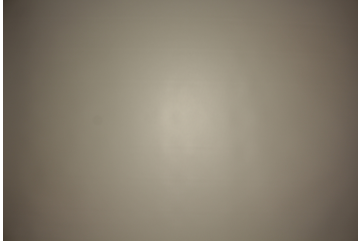
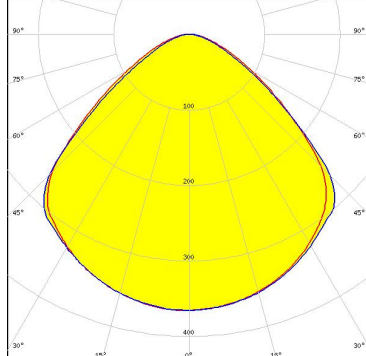
#### PHOTOMETRIC DATA (MEASURED):

<p>bridgelux.</p> <p>LED V22 Gen7</p> <p>FWHM 101.0°</p> <p>Efficiency 87 %</p> <p>Peak intensity 0.4 cd/lm</p> <p>LEDs/each optic 1</p> <p>Light colour White</p> <p>Required components:</p>		
<p>bridgelux.</p> <p>LED V22 Gen7</p> <p>FWHM 102.0°</p> <p>Efficiency 92 %</p> <p>Peak intensity 0.4 cd/lm</p> <p>LEDs/each optic 1</p> <p>Light colour White</p> <p>Required components: TE Connectivity: 2213480-1</p>		
<p>bridgelux.</p> <p>LED Vero SE 13</p> <p>FWHM 101.0°</p> <p>Efficiency 90 %</p> <p>Peak intensity 0.4 cd/lm</p> <p>LEDs/each optic 1</p> <p>Light colour White</p> <p>Required components:</p>		
<p>bridgelux.</p> <p>LED Vero SE 18</p> <p>FWHM 101.0°</p> <p>Efficiency 90 %</p> <p>Peak intensity 0.4 cd/lm</p> <p>LEDs/each optic 1</p> <p>Light colour White</p> <p>Required components:</p>		

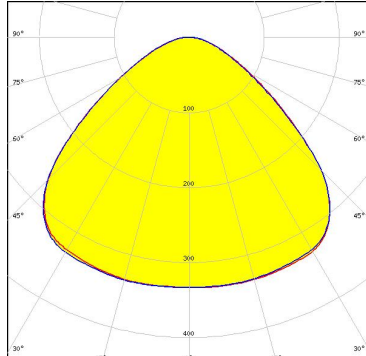
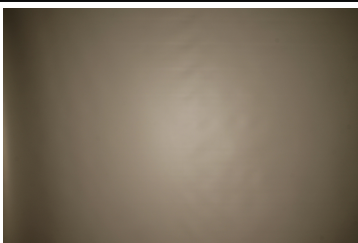
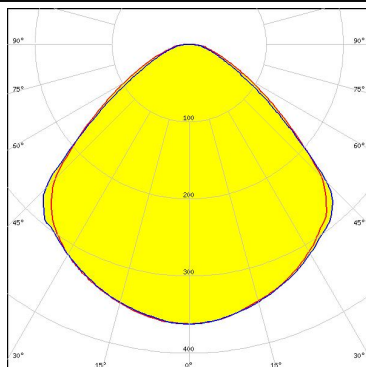
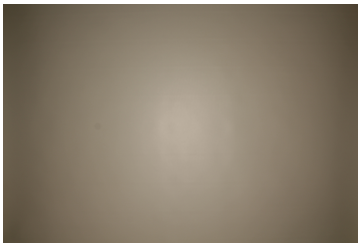
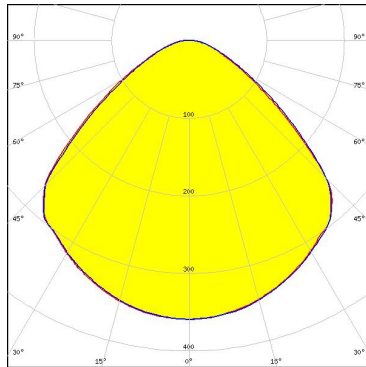

#### PHOTOMETRIC DATA (MEASURED):

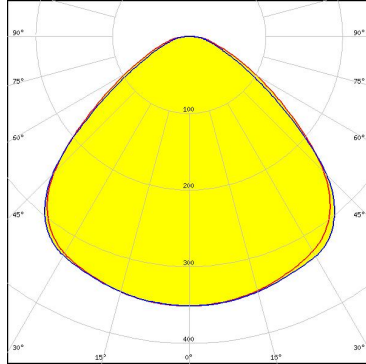
<p>bridgelux.</p> <p>LED            Vero SE 29</p> <p>FWHM        105.0°</p> <p>Efficiency    92 %</p> <p>Peak intensity 0.3 cd/lm</p> <p>LEDs/each optic 1</p> <p>Light colour    White</p> <p>Required components:</p>		
<p>bridgelux.</p> <p>LED            VERO13</p> <p>FWHM        100.0°</p> <p>Efficiency    88 %</p> <p>Peak intensity 0.4 cd/lm</p> <p>LEDs/each optic 1</p> <p>Light colour    White</p> <p>Required components:</p>		
<p>bridgelux.</p> <p>LED            VERO18</p> <p>FWHM        102.0°</p> <p>Efficiency    89 %</p> <p>Peak intensity 0.4 cd/lm</p> <p>LEDs/each optic 1</p> <p>Light colour    White</p> <p>Required components:</p>		
<p>bridgelux.</p> <p>LED            VERO29</p> <p>FWHM        103.0°</p> <p>Efficiency    91 %</p> <p>Peak intensity 0.4 cd/lm</p> <p>LEDs/each optic 1</p> <p>Light colour    White</p> <p>Required components:</p>		

#### PHOTOMETRIC DATA (MEASURED):

#### CITIZEN

LED CLL02x/CLU02x (LES10)  
 FWHM 100.0°  
 Efficiency 88 %  
 Peak intensity 0.4 cd/lm  
 LEDs/each optic 1  
 Light colour White  
 Required components:

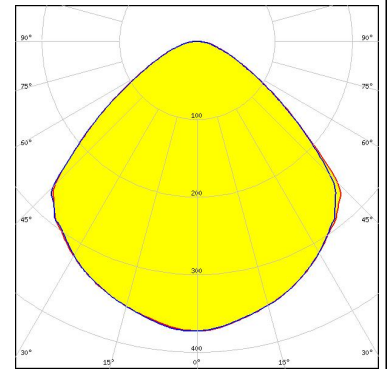
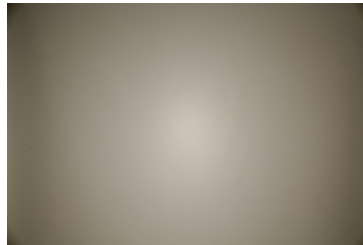

#### CITIZEN

LED CLL02x/CLU02x (LES10)  
 FWHM 100.0°  
 Efficiency 92 %  
 Peak intensity 0.4 cd/lm  
 LEDs/each optic 1  
 Light colour White  
 Required components:  
 F15255\_HEKLA-SOCKET-C

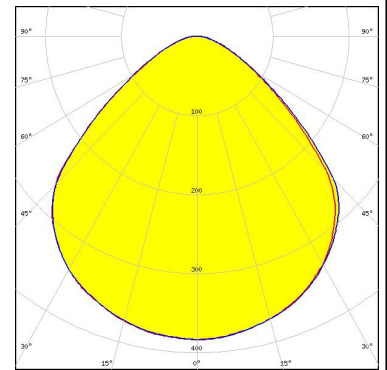

#### CITIZEN

LED CLL04x/CLU04x  
 FWHM 102.0°  
 Efficiency 89 %  
 Peak intensity 0.4 cd/lm  
 LEDs/each optic 1  
 Light colour White  
 Required components:

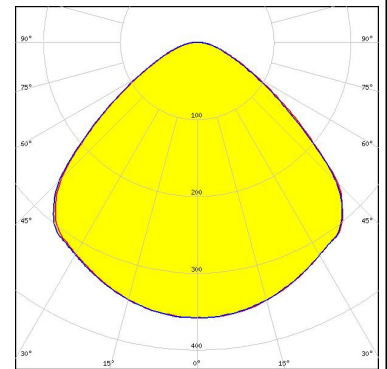

#### CREE

LED CMA2550  
 FWHM 102.0°  
 Efficiency 88 %  
 Peak intensity 0.4 cd/lm  
 LEDs/each optic 1  
 Light colour White  
 Required components:

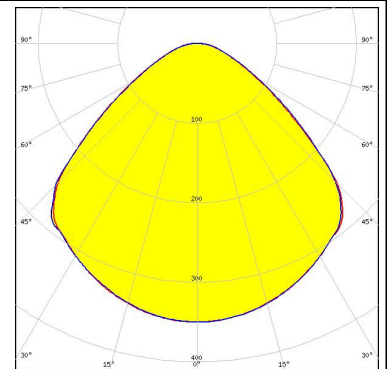
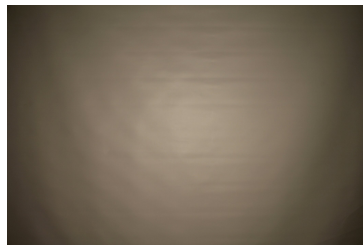

#### PHOTOMETRIC DATA (MEASURED):

**CREE** 

LED CMA3090  
 FWHM 102.0°  
 Efficiency 88 %  
 Peak intensity 0.3 cd/lm  
 LEDs/each optic 1  
 Light colour White  
 Required components:

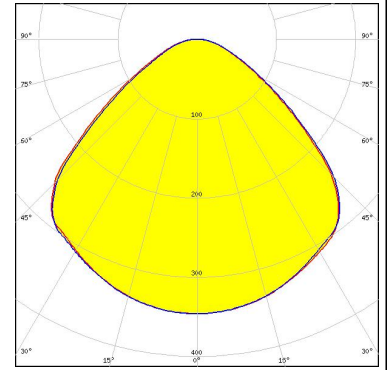

**CREE** 

LED CMT19xx  
 FWHM 101.0°  
 Efficiency 89 %  
 Peak intensity 0.4 cd/lm  
 LEDs/each optic 1  
 Light colour White  
 Required components:  
 Bender Wirth: 477 Typ Z1

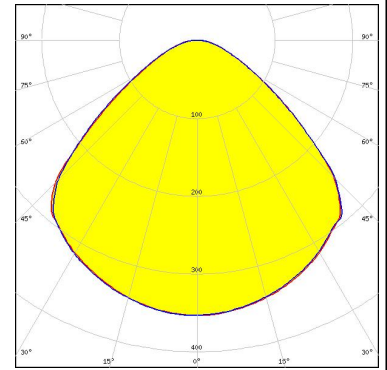
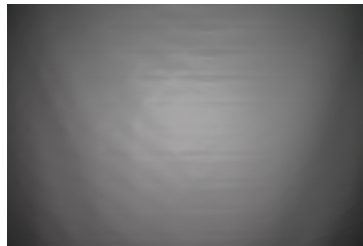

**CREE** 

LED CXA/B 1816 & CXA/B 1820 & CXA 1850  
 FWHM 102.0°  
 Efficiency 87 %  
 Peak intensity 0.4 cd/lm  
 LEDs/each optic 1  
 Light colour White  
 Required components:

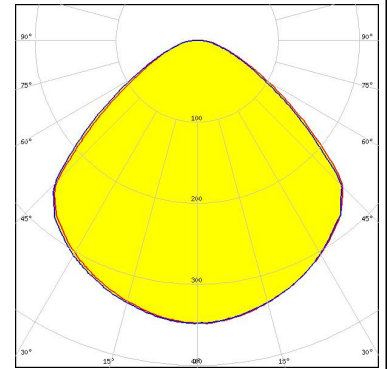
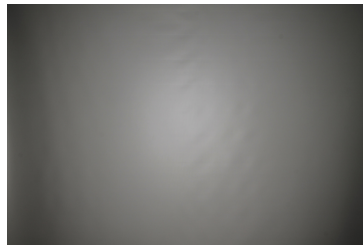

**CREE** 

LED CXA/B 1830  
 FWHM 102.0°  
 Efficiency 88 %  
 Peak intensity 0.4 cd/lm  
 LEDs/each optic 1  
 Light colour White  
 Required components:  
 C14305\_STELLA-CLAMP-CXA15-18

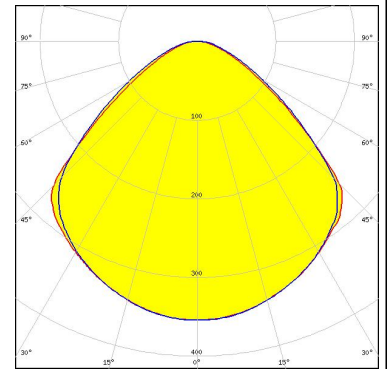
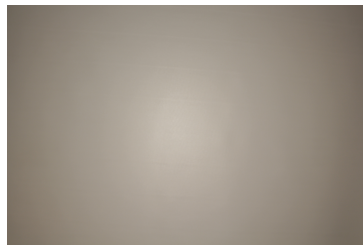

#### PHOTOMETRIC DATA (MEASURED):

**CREE** 

LED CXA/B 25xx  
 FWHM 101.0°  
 Efficiency 90 %  
 Peak intensity 0.4 cd/lm  
 LEDs/each optic 1  
 Light colour White  
 Required components:  
 Bender Wirth: 439 Typ L3

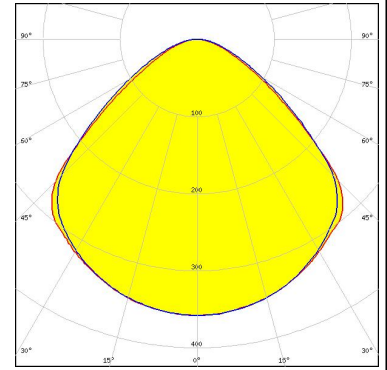

**CREE** 

LED CXA/B 25xx  
 FWHM 102.0°  
 Efficiency 88 %  
 Peak intensity 0.4 cd/lm  
 LEDs/each optic 1  
 Light colour White  
 Required components:

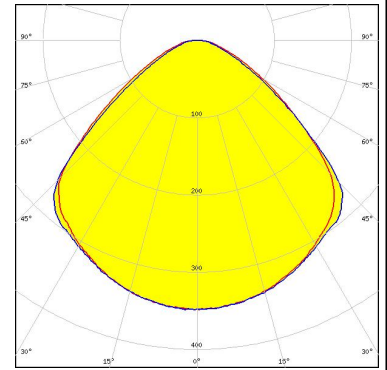

**CREE** 

LED CXA/B 30xx  
 FWHM 102.0°  
 Efficiency 88 %  
 Peak intensity 0.4 cd/lm  
 LEDs/each optic 1  
 Light colour White  
 Required components:

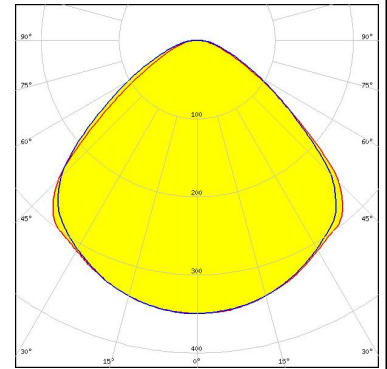
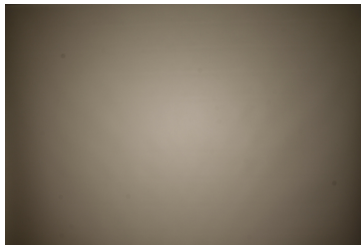

**CREE** 

LED CXA/B 3590  
 FWHM 102.0°  
 Efficiency 90 %  
 Peak intensity 0.4 cd/lm  
 LEDs/each optic 1  
 Light colour White  
 Required components:

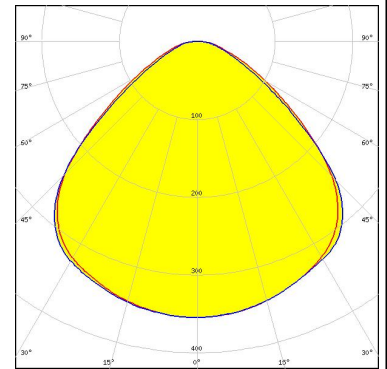



#### PHOTOMETRIC DATA (MEASURED):

#### LUMILEDS

LED LUXEON CoB 1211  
 FWHM 101.0°  
 Efficiency 89 %  
 Peak intensity 0.4 cd/lm  
 LEDs/each optic 1  
 Light colour White  
 Required components:  
 Bender Wirth: 431 Typ L3

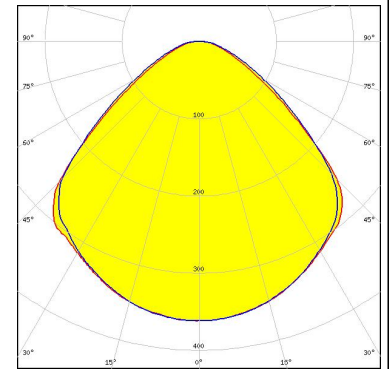
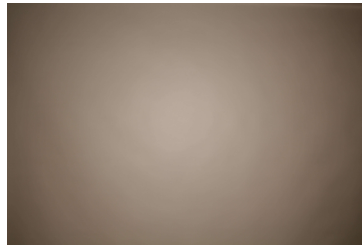

#### LUMILEDS

LED LUXEON CoB 1321  
 FWHM 102.0°  
 Efficiency 89 %  
 Peak intensity 0.3 cd/lm  
 LEDs/each optic 1  
 Light colour White  
 Required components:

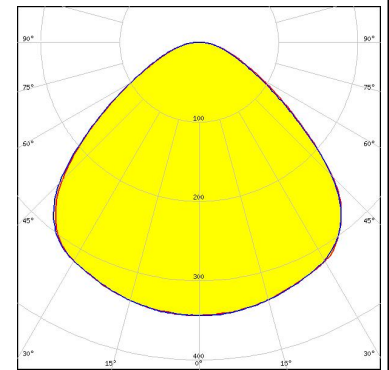
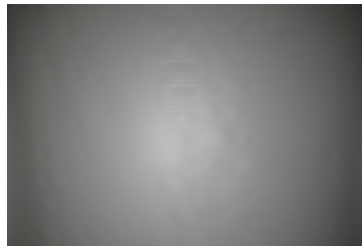

#### LUMILEDS

LED LUXEON CoB 1825  
 FWHM 100.0°  
 Efficiency 88 %  
 Peak intensity 0.4 cd/lm  
 LEDs/each optic 1  
 Light colour White  
 Required components:

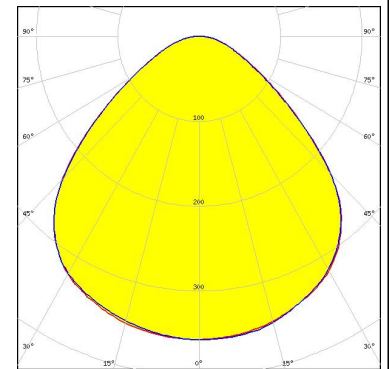
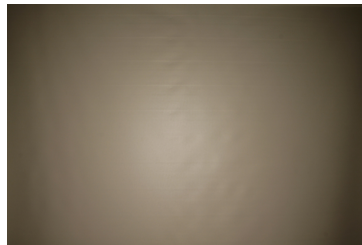

#### NICHIA

LED COB H-Type  
 FWHM 101.0°  
 Efficiency 89 %  
 Peak intensity 0.4 cd/lm  
 LEDs/each optic 1  
 Light colour White  
 Required components:

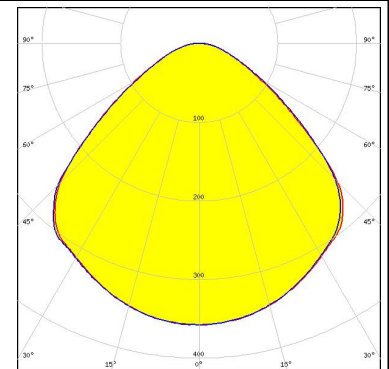
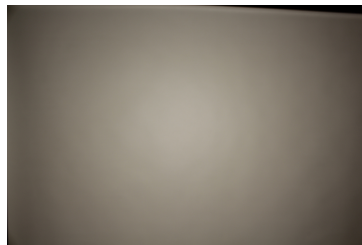



#### PHOTOMETRIC DATA (MEASURED):



LED COB J-Type  
 FWHM 102.0°  
 Efficiency 88 %  
 Peak intensity 0.4 cd/lm  
 LEDs/each optic 1  
 Light colour White  
 Required components:

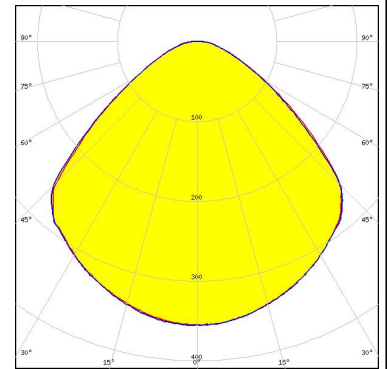
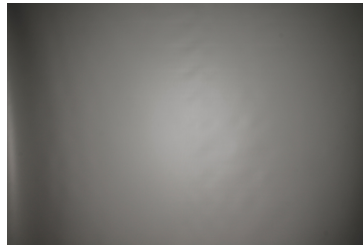

LED Fortimo SLM L19 + SLM holder (PI)  
 FWHM 101.0°  
 Efficiency 93 %  
 Peak intensity 0.4 cd/lm  
 LEDs/each optic 1  
 Light colour White  
 Required components:

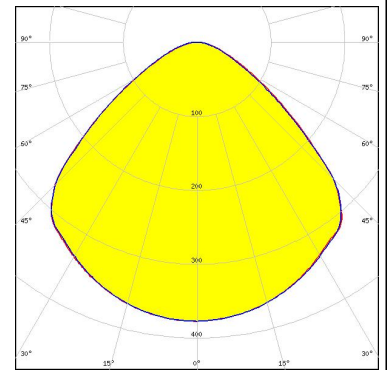
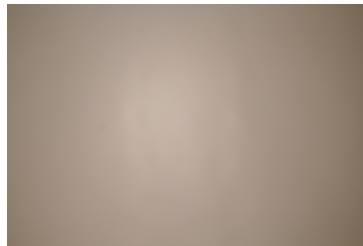

LED Fortimo SLM L19 CoB  
 FWHM 100.0°  
 Efficiency 88 %  
 Peak intensity 0.4 cd/lm  
 LEDs/each optic 1  
 Light colour White  
 Required components:  
 Bender Wirth: 431 Typ Z1

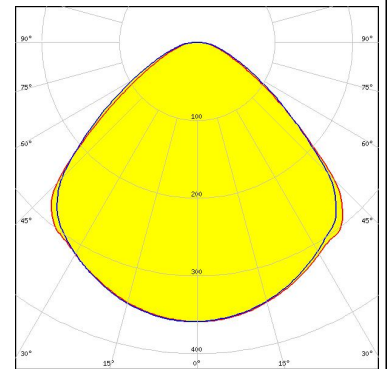
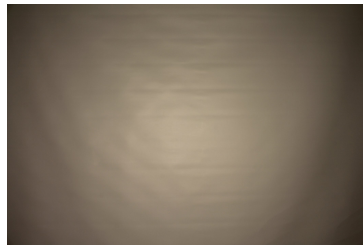

LED Fortimo SLM L23 CoB  
 FWHM 145.0°  
 Efficiency 88 %  
 Peak intensity 0.4 cd/lm  
 LEDs/each optic 1  
 Light colour White  
 Required components:  
 Bender Wirth: 431 Typ Z1

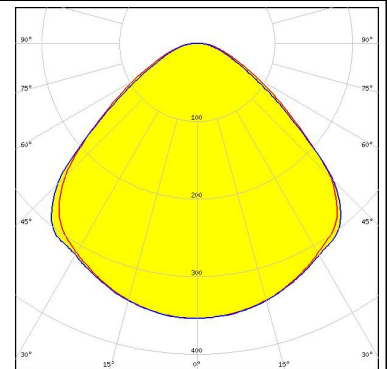
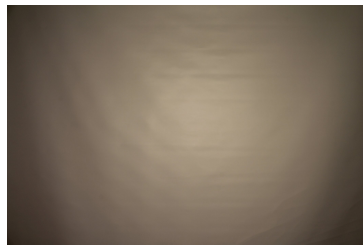

#### PHOTOMETRIC DATA (MEASURED):

### SAMSUNG

LED LC040D / LC060D / LC080D  
 FWHM 102.0°  
 Efficiency 88 %  
 Peak intensity 0.4 cd/lm  
 LEDs/each optic 1  
 Light colour White  
 Required components:

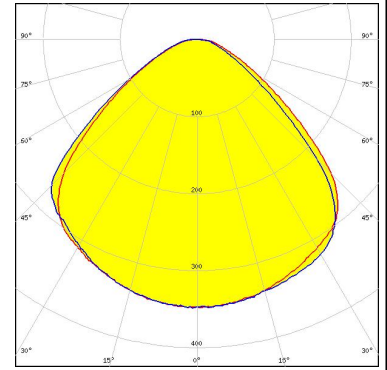
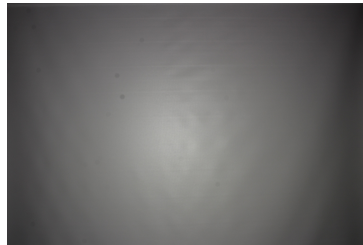

SEOUL SEMICONDUCTOR

LED MJT COB LES 14.5  
 FWHM 101.0°  
 Efficiency 87 %  
 Peak intensity 0.4 cd/lm  
 LEDs/each optic 1  
 Light colour White  
 Required components:

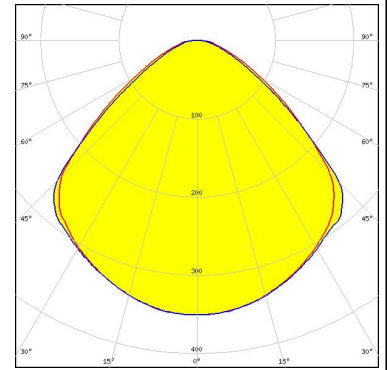

SEOUL SEMICONDUCTOR

LED MJT COB LES 14.5  
 FWHM 101.0°  
 Efficiency 90 %  
 Peak intensity 0.5 cd/lm  
 LEDs/each optic 1  
 Light colour White  
 Required components:  
 Bender Wirth: 433 Typ Z1

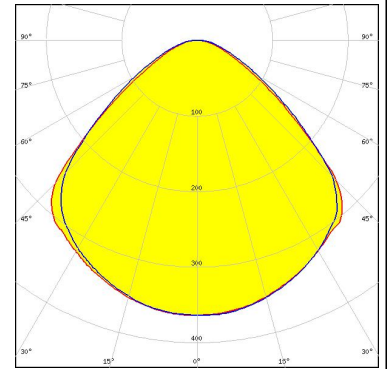
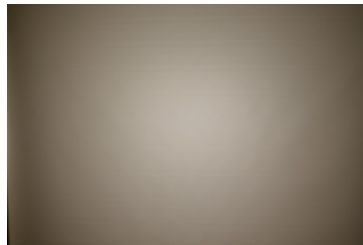

SEOUL SEMICONDUCTOR

LED MJT COB LES 22  
 FWHM 101.0°  
 Efficiency 89 %  
 Peak intensity 0.4 cd/lm  
 LEDs/each optic 1  
 Light colour White  
 Required components:  
 IDEAL: 50-2204CT

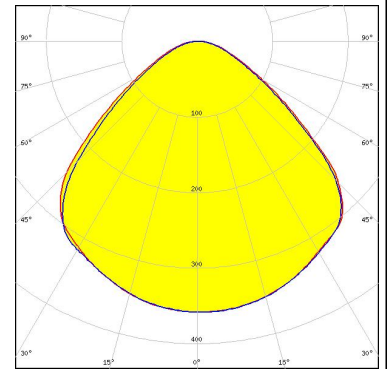

#### PHOTOMETRIC DATA (MEASURED):

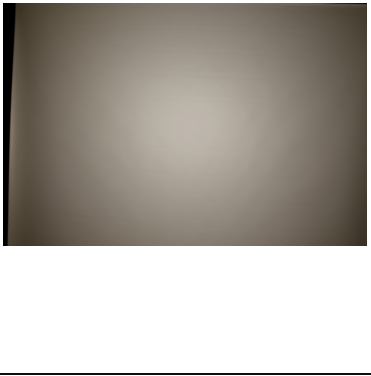
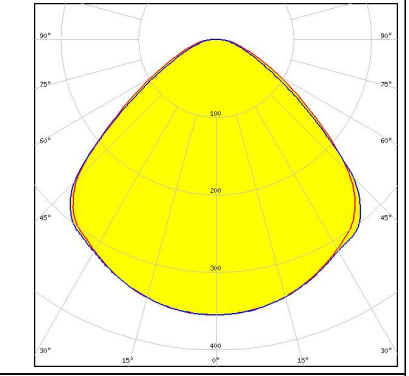
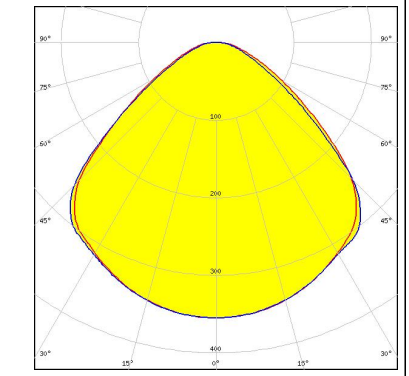
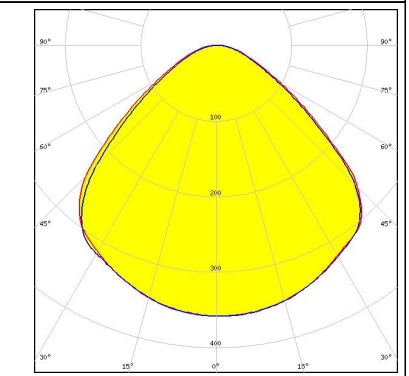
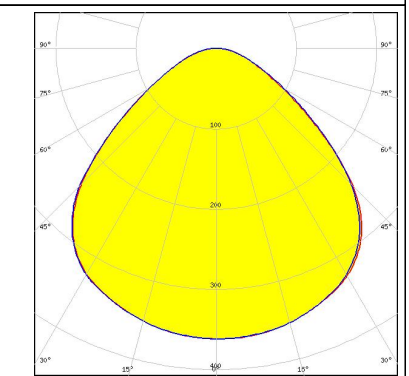
<p>SEOL SEMICONDUCTOR</p> <p>LED MJT COB LES 22</p> <p>FWHM 101.0°</p> <p>Efficiency 89 %</p> <p>Peak intensity 0.4 cd/lm</p> <p>LEDs/each optic 1</p> <p>Light colour White</p> <p>Required components: Bender Wirth: 431 Typ Z1</p>		
<p>SEOL SEMICONDUCTOR</p> <p>LED MJT COB LES 22</p> <p>FWHM 101.0°</p> <p>Efficiency 89 %</p> <p>Peak intensity 0.4 cd/lm</p> <p>LEDs/each optic 1</p> <p>Light colour White</p> <p>Required components: Bender Wirth: 431 Typ Z1</p>		
<p>SEOL SEMICONDUCTOR</p> <p>LED MJT COB LES 22</p> <p>FWHM 101.0°</p> <p>Efficiency 89 %</p> <p>Peak intensity 0.4 cd/lm</p> <p>LEDs/each optic 1</p> <p>Light colour White</p> <p>Required components: IDEAL: 50-2204CT</p>		
<p>SEOL SEMICONDUCTOR</p> <p>LED MJT COB LES 33</p> <p>FWHM 101.0°</p> <p>Efficiency 90 %</p> <p>Peak intensity 0.4 cd/lm</p> <p>LEDs/each optic 1</p> <p>Light colour White</p> <p>Required components: Bender Wirth: 458 Typ L4</p>		

#### PHOTOMETRIC DATA (SIMULATED):

<p>bridgelux.</p> <p>LED V10 Gen7</p> <p>FWHM 95.0°</p> <p>Efficiency 88 %</p> <p>Peak intensity 0.4 cd/lm</p> <p>LEDs/each optic 1</p> <p>Light colour White</p> <p>Required components: Bender Wirth: 486 Typ L1</p>	
<p>bridgelux.</p> <p>LED V13 Gen7</p> <p>FWHM 94.0°</p> <p>Efficiency 94 %</p> <p>Peak intensity 0.4 cd/lm</p> <p>LEDs/each optic 1</p> <p>Light colour White</p> <p>Required components:</p>	
<p>bridgelux.</p> <p>LED V13 Gen7</p> <p>FWHM 94.0°</p> <p>Efficiency 94 %</p> <p>Peak intensity 0.4 cd/lm</p> <p>LEDs/each optic 1</p> <p>Light colour White</p> <p>Required components: Bender Wirth: 477 Typ Z1</p>	
<p>bridgelux.</p> <p>LED V22 Gen7</p> <p>FWHM 94.0°</p> <p>Efficiency 94 %</p> <p>Peak intensity 0.5 cd/lm</p> <p>LEDs/each optic 1</p> <p>Light colour White</p> <p>Required components: Bender Wirth: 431 Typ Z1</p>	

#### PHOTOMETRIC DATA (SIMULATED):



**LED** V22 Gen7  
**FWHM** 96.0°  
**Efficiency** 94 %  
**Peak intensity** 0.5 cd/lm  
**LEDs/each optic** 1  
**Light colour** White  
**Required components:**  
 IDEAL: 50-2204CT

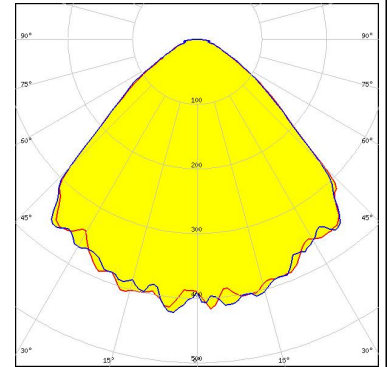

#### CITIZEN

**LED** CLL03x/CLU03x  
**FWHM** 98.0°  
**Efficiency** 90 %  
**Peak intensity** 0.4 cd/lm  
**LEDs/each optic** 1  
**Light colour** White  
**Required components:**

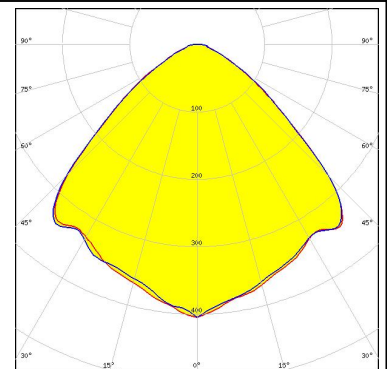

#### CITIZEN

**LED** CLL05x/CLU05x  
**FWHM** 97.0°  
**Efficiency** 87 %  
**Peak intensity** 0.4 cd/lm  
**LEDs/each optic** 1  
**Light colour** White  
**Required components:**

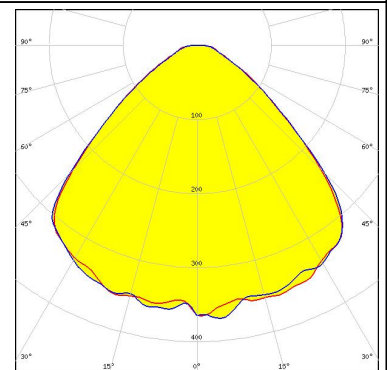

**LED** CMA3090  
**FWHM** 97.0°  
**Efficiency** 94 %  
**Peak intensity** 0.4 cd/lm  
**LEDs/each optic** 1  
**Light colour** White  
**Required components:**

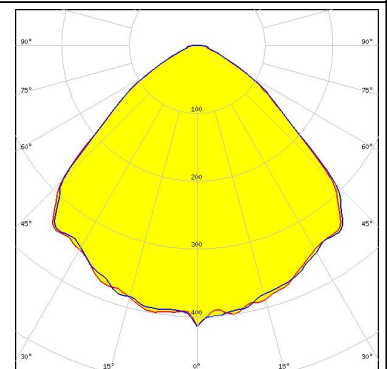



#### PHOTOMETRIC DATA (SIMULATED):

**CREE** 

LED CXA/B 25xx  
 FWHM 98.0°  
 Efficiency 89 %  
 Peak intensity 0.4 cd/lm  
 LEDs/each optic 1  
 Light colour White  
 Required components:

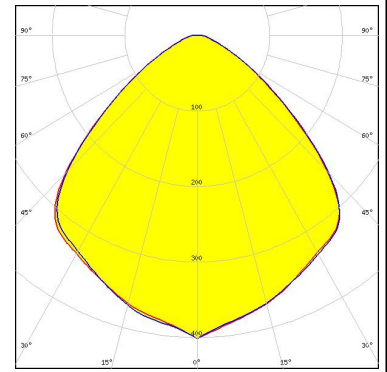

**LITEON**

LED LTPL-G35UV275GR-E  
 FWHM 92.0°  
 Efficiency 71 %  
 LEDs/each optic 13  
 Light colour UV-C  
 Required components:

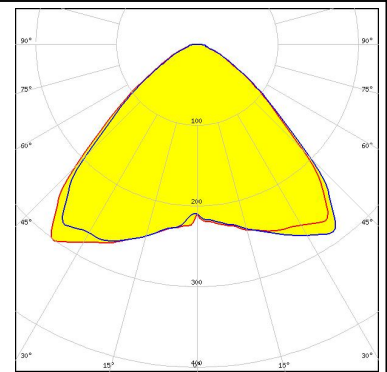
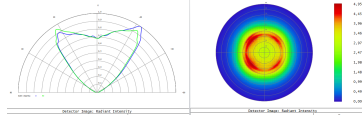

The UVC LED result tolerance is  $\pm 10$  %

**LITEON**

LED LTPL-G35UV275GR-E  
 FWHM 92.0°  
 Efficiency 70 %  
 LEDs/each optic 4  
 Light colour UV-C  
 Required components:

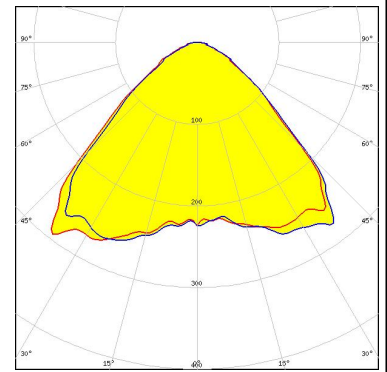
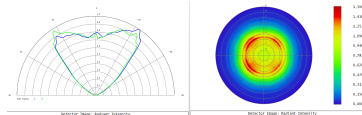

The UVC LED result tolerance is  $\pm 10$  %

**LITEON**

LED LTPL-G35UV275GR-E  
 FWHM 92.0°  
 Efficiency 70 %  
 LEDs/each optic 3  
 Light colour UV-C  
 Required components:

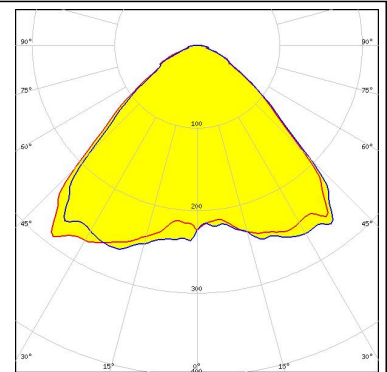
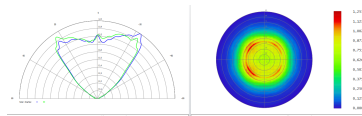

The UVC LED result tolerance is  $\pm 10$  %

#### PHOTOMETRIC DATA (SIMULATED):



LED LUXEON CoB 1216/1812  
 FWHM 99.0°  
 Efficiency 91 %  
 Peak intensity 0.4 cd/lm  
 LEDs/each optic 1  
 Light colour White  
 Required components:  
 Bender Wirth: 431 Typ L4

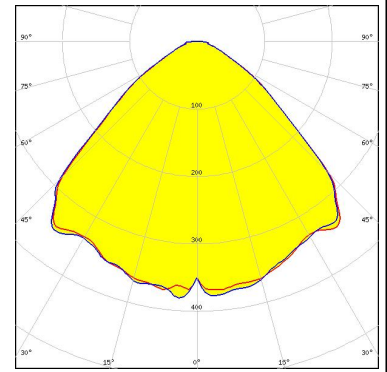

LED XBT-3535-UV  
 FWHM 100.0°  
 Efficiency 70 %  
 LEDs/each optic 1  
 Light colour UV-C  
 Required components:

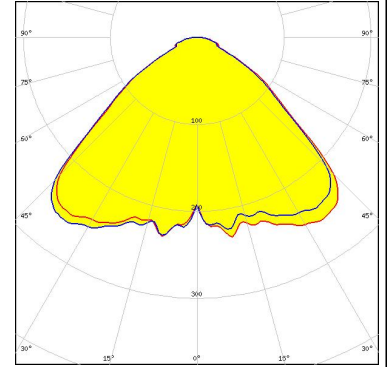
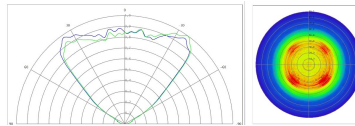

The UVC LED result tolerance is ±10 %



LED NCSU334A  
 FWHM 93.0°  
 Efficiency 73 %  
 LEDs/each optic 1  
 Light colour UV-A  
 Required components:

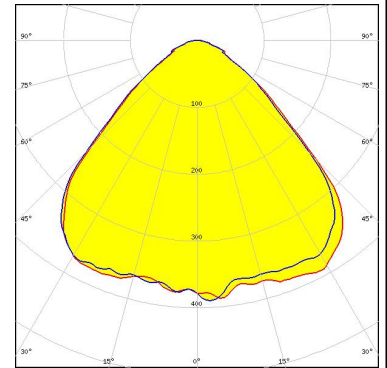
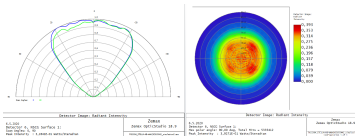

LED CUD8AF1D  
 FWHM 100.0°  
 Efficiency 69 %  
 LEDs/each optic 16  
 Light colour UV-C  
 Required components:

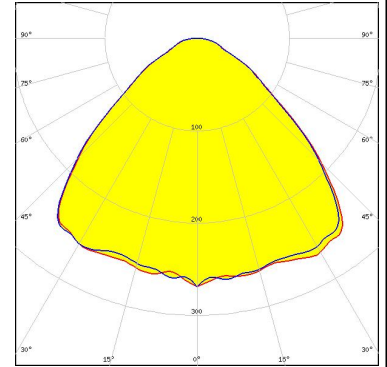
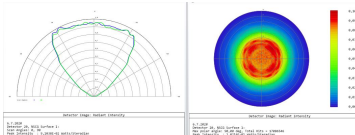

The UVC LED result tolerance is ±10 %

### PHOTOMETRIC DATA (SIMULATED):

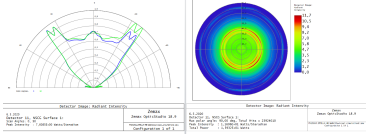
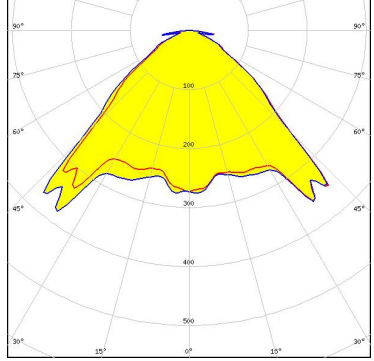
			
LED	WICOP DY9560-27		
FWHM	92.0°		
Efficiency	66 %		
LEDs/each optic	24		
Light colour	UV-C		
Required components:			
<div style="border: 1px solid black; padding: 5px; display: inline-block;">The UVC LED result tolerance is <math>\pm 10</math> %</div>			

<h2>TRIDONIC</h2>		
LED	SLE G7 LES21	
FWHM	96.0°	
Efficiency	94 %	
Peak intensity	0.4 cd/lm	
LEDs/each optic	1	
Light colour	White	
Required components:		

### GENERAL INFORMATION:

NOTE: The typical beam angle will be changed by different color, chip size and chip position tolerance. The typical total beam angle is the full angle measured where the luminous intensity is half of the peak value.

Due to use of high power COB's with this product, special attention to proper thermal design is highly recommended. LEDiL has no liability for direct, indirect or consecutive damages arising from the LEDiL products being used outside of the recommended temperature range.

### MATERIALS:

As part of our continuous research and improvement processes, and to ensure the best possible quality and availability of our products, LEDiL reserves the right to change material grades without notice.

### PRODUCT DATA USER AGREEMENT AND DISCLAIMER:

The measured data in the provided downloadable LEDiL Product Datasheets and Mechanical 2D-Drawings is rounded and provided as reference for planning. LEDiL Oy's optical specifications have been verified by conducting performance testing of the products in accordance with the company's quality system. The reported data are averaged results of multiple measurements with typical variation. LEDiL Oy reserves the right to without prior notification make changes and improvements to its products.

LEDiL Oy assumes neither warranty, nor guarantee nor any other liability of any kind for the contents and correctness of the provided data. The provided data has been generated with highest diligence but the provided data may in reality not represent the complete possible variation range of all intrinsic parameters. Therefore, in certain cases a deviation from the provided data could occur.

LEDiL Oy reserves the right to undertake technical changes of its products without further notification which could lead to changes in the provided data. LEDiL Oy assumes no liability of any kind for the possible deviation from any provided data or any other damage resulting from the usage of the provided data.

The user agrees to this disclaimer and user agreement with the download or usage of the provided files.

#### LEDiL Oy

Joensuunkatu 13  
FI-24240 SALO  
Finland

#### LEDiL Inc.

228 West Page Street  
Suite D  
Sycamore IL 60178  
USA

#### Ledil Optics Technology (Shenzhen) Co., Ltd.

# 405 , Block B  
Casic Motor Building  
Shenzhen 518057  
P.R.CHINA

#### Local sales and technical support

[www.ledil.com/  
where\\_to\\_buy](http://www.ledil.com/where_to_buy)

#### Shipping locations

Salo, Finland  
Hong Kong, China

#### Distribution Partners

[www.ledil.com/  
where\\_to\\_buy](http://www.ledil.com/where_to_buy)