

BROOKE-G2-S

~20° spot beam compatible with LEDiL HEKLA.

TECHNICAL SPECIFICATIONS:

Dimensions	Ø 45.0 mm
Height	18.9 mm
Fastening	socket
Colour	metal
Box size	480 x 280 x 300 mm
Box weight	4.8 kg
Quantity in Box	720 pcs
ROHS compliant	yes ⓘ





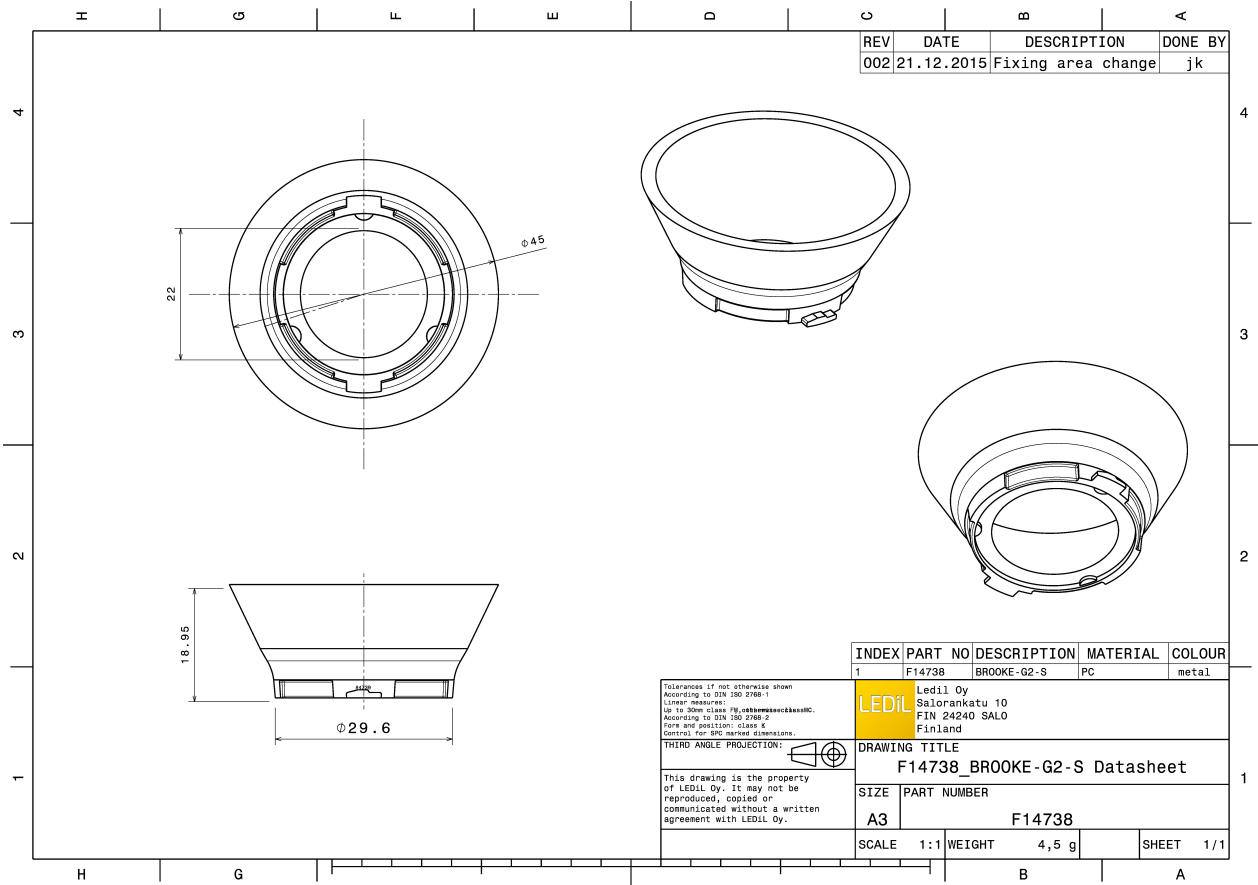

MATERIAL SPECIFICATIONS:

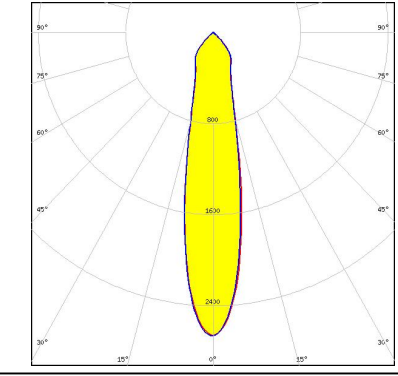
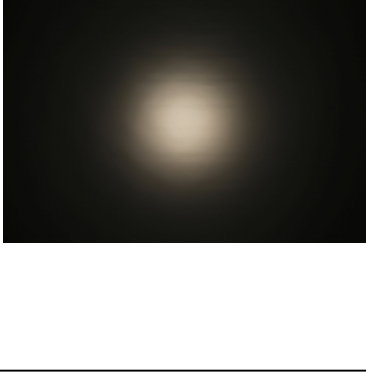
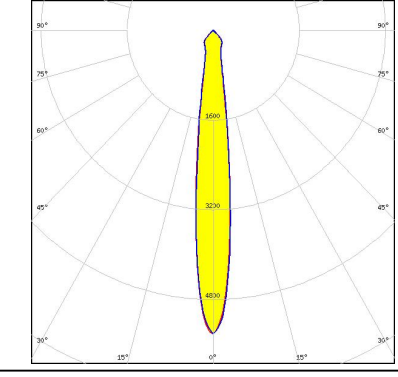

Component	Type	Material	Colour	Coating
BROOKE-G2-S	Reflector	PC	metal	HMDS

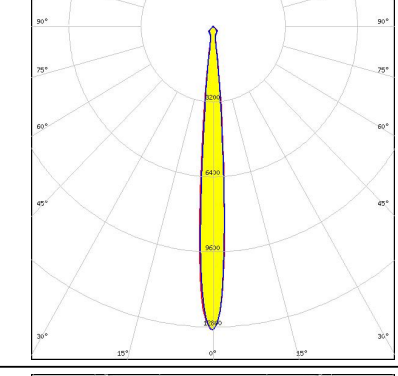

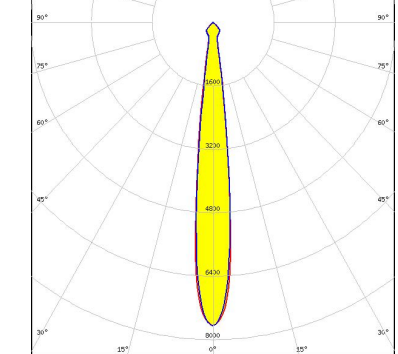

PHOTOMETRIC DATA (MEASURED):

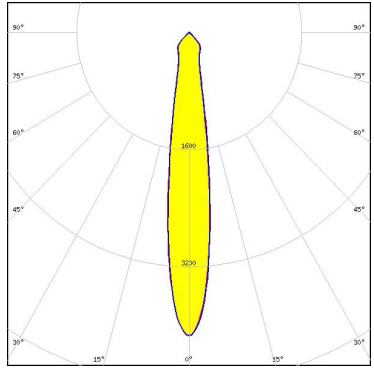
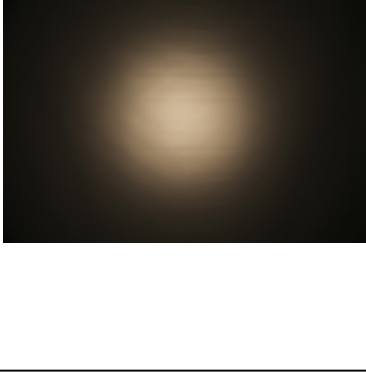
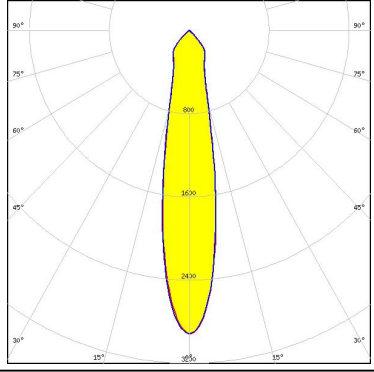
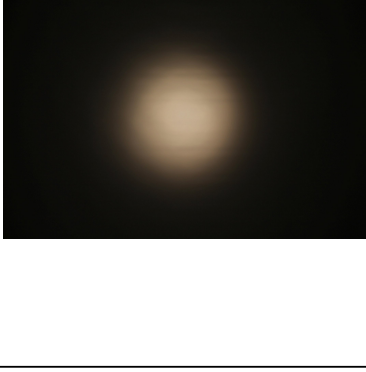
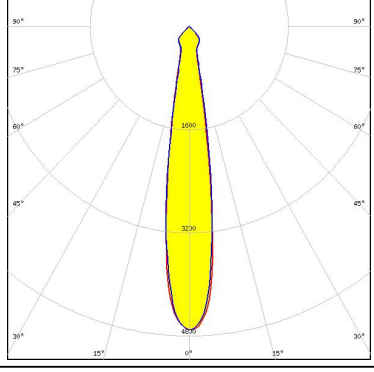
<p>bridgelux.</p> <p>LED V10 Gen7</p> <p>FWHM 22.0°</p> <p>Efficiency 88 %</p> <p>Peak intensity 2.700 cd/lm</p> <p>LEDs/each optic 1</p> <p>Light colour White</p> <p>Required components: F15255_HEKLA-SOCKET-C C14658_BARBARA-RZ-LENS</p>		
<p>bridgelux.</p> <p>LED V4 HD</p> <p>FWHM 13.0°</p> <p>Efficiency 90 %</p> <p>Peak intensity 5.400 cd/lm</p> <p>LEDs/each optic 1</p> <p>Light colour White</p> <p>Required components: F15253_HEKLA-SOCKET-A C14658_BARBARA-RZ-LENS</p>		
<p>bridgelux.</p> <p>LED V4 HD</p> <p>FWHM 8.8°</p> <p>Efficiency 94 %</p> <p>Peak intensity 12.900 cd/lm</p> <p>LEDs/each optic 1</p> <p>Light colour White</p> <p>Required components: F15253_HEKLA-SOCKET-A</p>		
<p>bridgelux.</p> <p>LED V6 HD</p> <p>FWHM 12.0°</p> <p>Efficiency 94 %</p> <p>Peak intensity 7.650 cd/lm</p> <p>LEDs/each optic 1</p> <p>Light colour White</p> <p>Required components: F15255_HEKLA-SOCKET-C</p>		

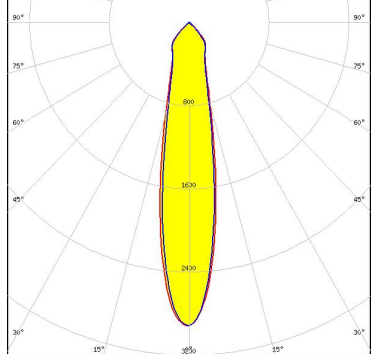

PHOTOMETRIC DATA (MEASURED):

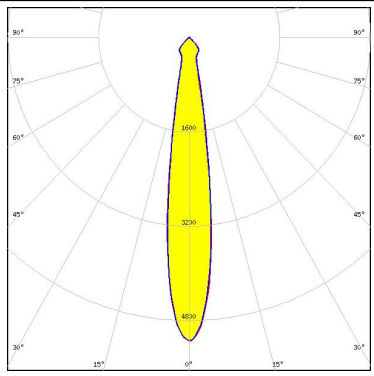
<p>bridgelux.</p> <p>LED V6 HD FWHM 16.0° Efficiency 89 % Peak intensity 4.100 cd/lm LEDs/each optic 1 Light colour White</p> <p>Required components: F15255_HEKLA-SOCKET-C C14658_BARBARA-RZ-LENS</p>		
<p>bridgelux.</p> <p>LED V9 HD FWHM 21.0° Efficiency 87 % Peak intensity 2.900 cd/lm LEDs/each optic 1 Light colour White</p> <p>Required components: F15859_HEKLA-SOCKET-I C14658_BARBARA-RZ-LENS</p>		
<p>bridgelux.</p> <p>LED V9 HD FWHM 17.0° Efficiency 94 % Peak intensity 4.700 cd/lm LEDs/each optic 1 Light colour White</p> <p>Required components: F15859_HEKLA-SOCKET-I</p>		
<p>bridgelux.</p> <p>LED VERO10 FWHM 21.0° Efficiency 92 % Peak intensity 2.900 cd/lm LEDs/each optic 1 Light colour White</p> <p>Required components: F15616_HEKLA-SOCKET-F C14658_BARBARA-RZ-LENS</p>		

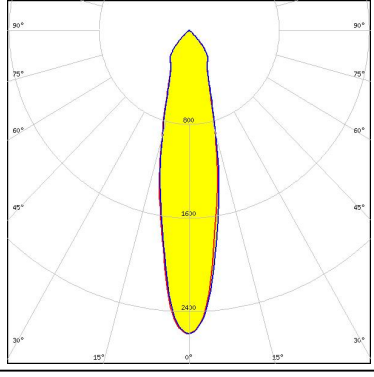
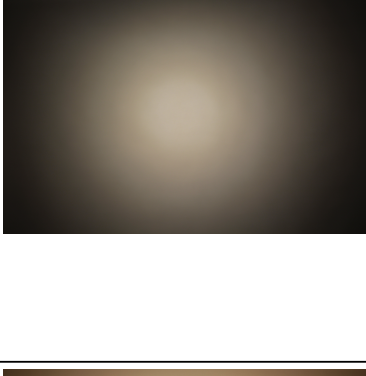
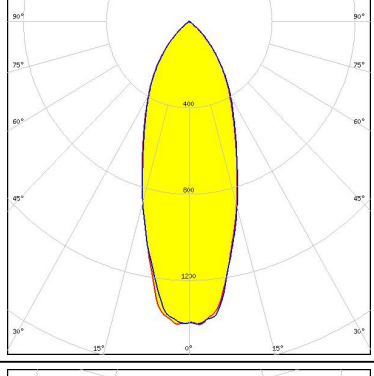
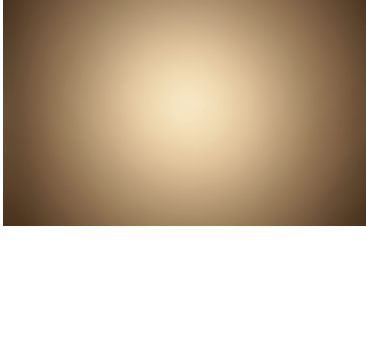
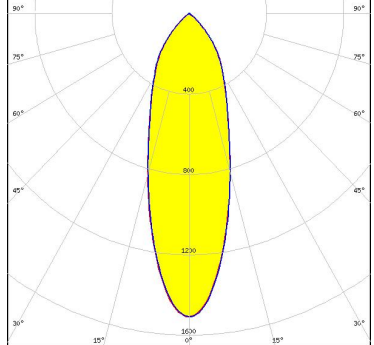



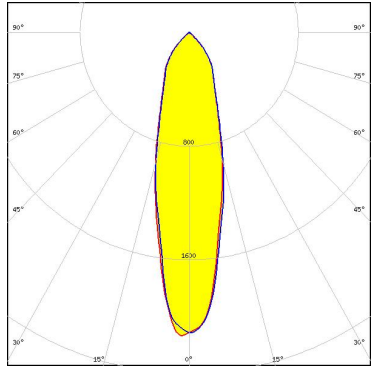
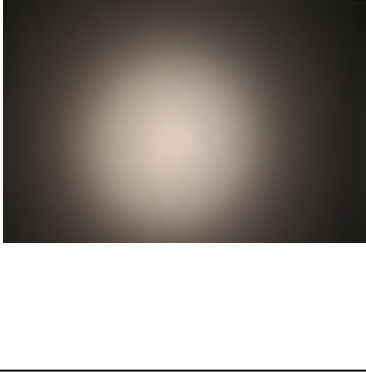
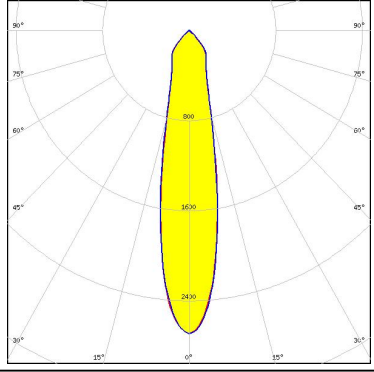
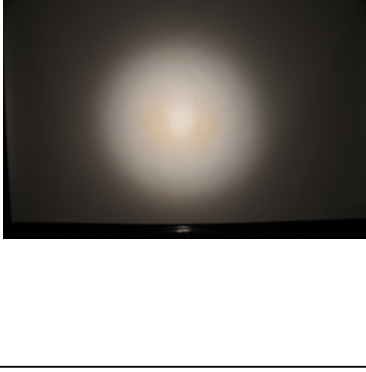
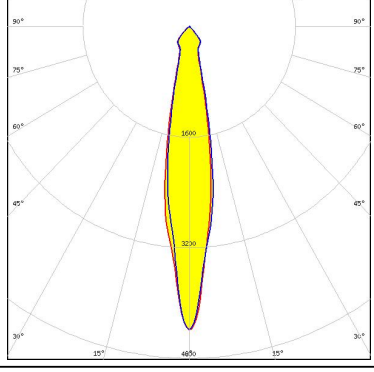

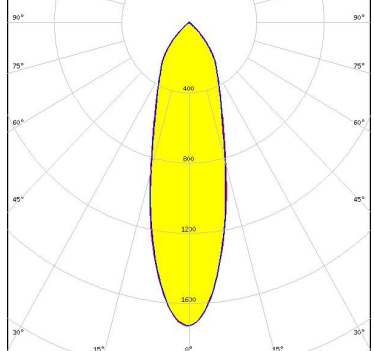
PHOTOMETRIC DATA (MEASURED):

<p>bridgelux.</p> <p>LED VERO10 FWHM 16.0° Efficiency 94 % Peak intensity 5.100 cd/lm LEDs/each optic 1 Light colour White Required components: F15616_HEKLA-SOCKET-F</p>		
<p>bridgelux.</p> <p>LED VERO13 FWHM 23.0° Efficiency 90 % Peak intensity 2.600 cd/lm LEDs/each optic 1 Light colour White Required components: C16142_HEKLA-SOCKET-K</p>		
<p>bridgelux.</p> <p>LED VERO18 FWHM 38.0° Efficiency 89 % Peak intensity 1.400 cd/lm LEDs/each optic 1 Light colour White Required components: C16142_HEKLA-SOCKET-K</p>		
<p>bridgelux.</p> <p>LED Vesta DTW 15mm (33W) FWHM 33.0° Efficiency 84 % Peak intensity 1.500 cd/lm LEDs/each optic 1 Light colour White Required components: C16142_HEKLA-SOCKET-K C14658_BARBARA-RZ-LENS Bender Wirth: 491 Typ L8</p>		

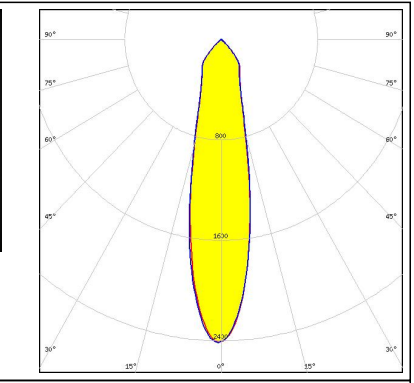
PHOTOMETRIC DATA (MEASURED):

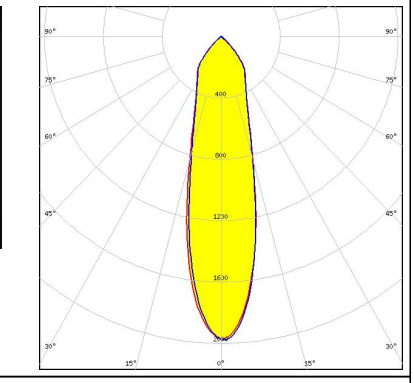
<p>bridgelux.</p> <p>LED Vesta DTW 15mm (33W)</p> <p>FWHM 27.0°</p> <p>Efficiency 91 %</p> <p>Peak intensity 2.100 cd/lm</p> <p>LEDs/each optic 1</p> <p>Light colour White</p> <p>Required components: C16142_HEKLA-SOCKET-K Bender Wirth: 491 Typ L8</p>		
<p>bridgelux.</p> <p>LED Vesta DTW 9mm (4W/6W/12W)</p> <p>FWHM 22.0°</p> <p>Efficiency 87 %</p> <p>Peak intensity 2.700 cd/lm</p> <p>LEDs/each optic 1</p> <p>Light colour White</p> <p>Required components: C16142_HEKLA-SOCKET-K C14658_BARBARA-RZ-LENS Bender Wirth: 490 Typ L8</p>		
<p>bridgelux.</p> <p>LED Vesta DTW 9mm (4W/6W/12W)</p> <p>FWHM 18.0°</p> <p>Efficiency 92 %</p> <p>Peak intensity 4.400 cd/lm</p> <p>LEDs/each optic 1</p> <p>Light colour White</p> <p>Required components: C16142_HEKLA-SOCKET-K Bender Wirth: 490 Typ L8</p>		
<p>bridgelux.</p> <p>LED Vesta TW 13mm (25W) CSP</p> <p>FWHM 30.0°</p> <p>Efficiency 85 %</p> <p>Peak intensity 1.700 cd/lm</p> <p>LEDs/each optic 1</p> <p>Light colour White</p> <p>Required components: C16142_HEKLA-SOCKET-K C14658_BARBARA-RZ-LENS Bender Wirth: 492 Typ L8</p>		

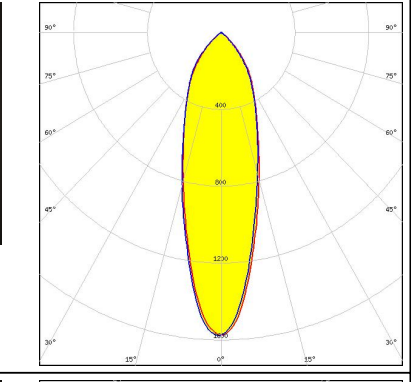
PHOTOMETRIC DATA (MEASURED):

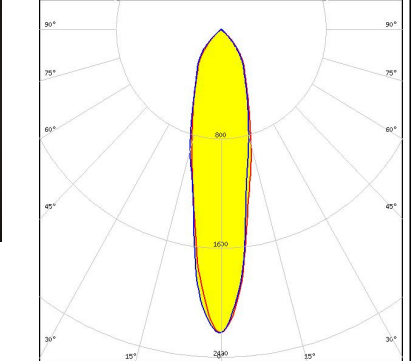
<p>bridgelux.</p> <p>LED Vesta TW 9mm (12W) CSP</p> <p>FWHM 23.0°</p> <p>Efficiency 85 %</p> <p>Peak intensity 2.400 cd/lm</p> <p>LEDs/each optic 1</p> <p>Light colour White</p> <p>Required components:</p> <ul style="list-style-type: none"> C16142_HEKLA-SOCKET-K C14658_BARBARA-RZ-LENS Bender Wirth: 489 Typ L8 		
<p>CITIZEN</p> <p>LED CLC020 Series (Dim-To-Warm)</p> <p>FWHM 26.0°</p> <p>Efficiency 84 %</p> <p>Peak intensity 2.000 cd/lm</p> <p>LEDs/each optic 1</p> <p>Light colour White</p> <p>Required components:</p> <ul style="list-style-type: none"> C16142_HEKLA-SOCKET-K C14658_BARBARA-RZ-LENS Bender Wirth: 487 Typ L8 		
<p>CITIZEN</p> <p>LED CLC030 Series (Dim-To-Warm)</p> <p>FWHM 30.0°</p> <p>Efficiency %</p> <p>Peak intensity 1.600 cd/lm</p> <p>LEDs/each optic 1</p> <p>Light colour White</p> <p>Required components:</p> <ul style="list-style-type: none"> C16142_HEKLA-SOCKET-K C14658_BARBARA-RZ-LENS Bender Wirth: 436 Typ L8 		
<p>CITIZEN</p> <p>LED CLC030 Series (Dim-To-Warm)</p> <p>FWHM 23.0°</p> <p>Efficiency 89 %</p> <p>Peak intensity 2.200 cd/lm</p> <p>LEDs/each optic 1</p> <p>Light colour White</p> <p>Required components:</p> <ul style="list-style-type: none"> C16142_HEKLA-SOCKET-K 		

PHOTOMETRIC DATA (MEASURED):

CITIZEN

LED CLL02x/CLU02x (LES10)
 FWHM 16.0°
 Efficiency 94 %
 Peak intensity 4.800 cd/lm
 LEDs/each optic 1
 Light colour White
 Required components:
 F15255_HEKLA-SOCKET-C

CITIZEN

LED CLL02x/CLU02x (LES10)
 FWHM 16.0°
 Efficiency 94 %
 Peak intensity 4.800 cd/lm
 LEDs/each optic 1
 Light colour White
 Required components:
 F15255_HEKLA-SOCKET-C

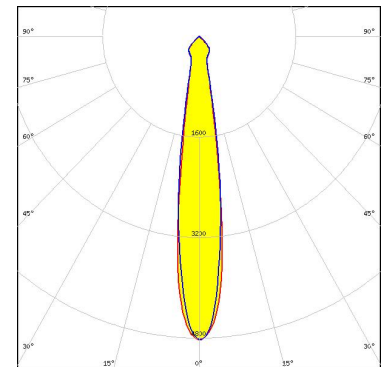
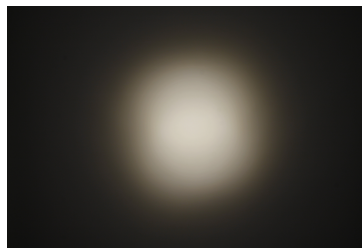

CITIZEN

LED CLU700/701
 FWHM 17.0°
 Efficiency 90 %
 Peak intensity 3.800 cd/lm
 LEDs/each optic 1
 Light colour White
 Required components:
 F15255_HEKLA-SOCKET-C
 C14658_BARBARA-RZ-LENS

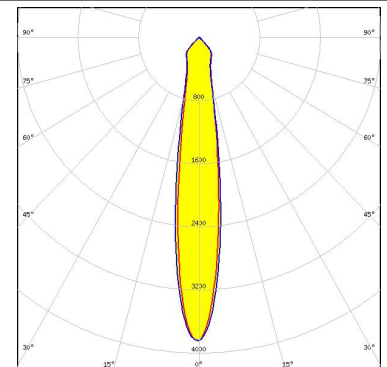
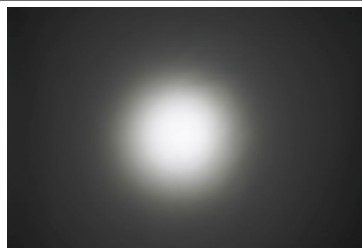

CITIZEN

LED CLU700/701
 FWHM 12.0°
 Efficiency 94 %
 Peak intensity 7.750 cd/lm
 LEDs/each optic 1
 Light colour White
 Required components:
 F15255_HEKLA-SOCKET-C

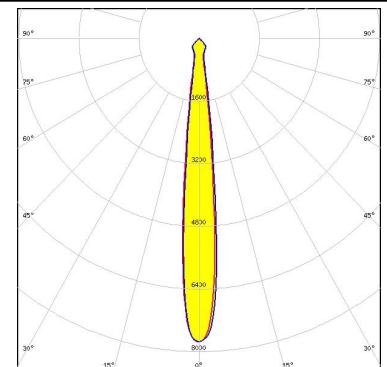

PHOTOMETRIC DATA (MEASURED):

CITIZEN

LED CLU7A2 (LES 4.2mm)
 FWHM 8.0°
 Efficiency 94 %
 Peak intensity 15.900 cd/lm
 LEDs/each optic 1
 Light colour White
 Required components:
 F15255_HEKLA-SOCKET-C

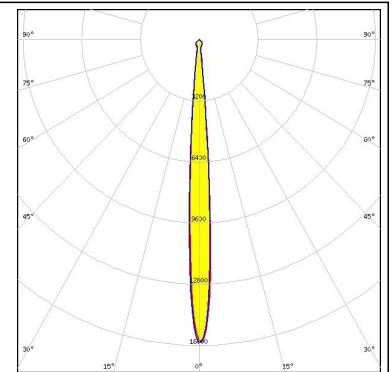

CITIZEN

LED LCN-C01B (Tunable White)
 FWHM 25.0°
 Efficiency 86 %
 Peak intensity 2.200 cd/lm
 LEDs/each optic 1
 Light colour White
 Required components:
 C16142_HEKLA-SOCKET-K
 C14658_BARBARA-RZ-LENS
 Bender Wirth: 481 Typ L8

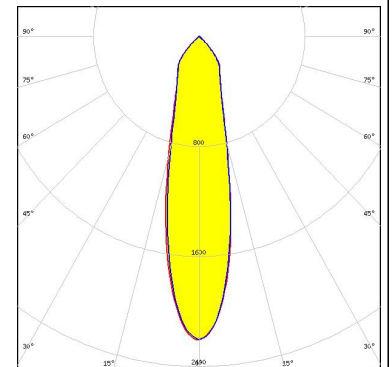
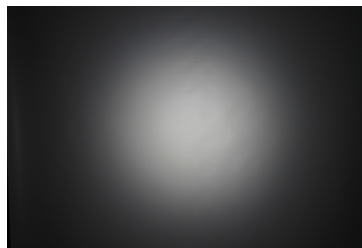

CITIZEN

LED LCN-C02B (Tunable White)
 FWHM 32.0°
 Efficiency 84 %
 Peak intensity 1.600 cd/lm
 LEDs/each optic 1
 Light colour White
 Required components:
 C16142_HEKLA-SOCKET-K
 C14658_BARBARA-RZ-LENS
 Bender Wirth: 481 Typ L8

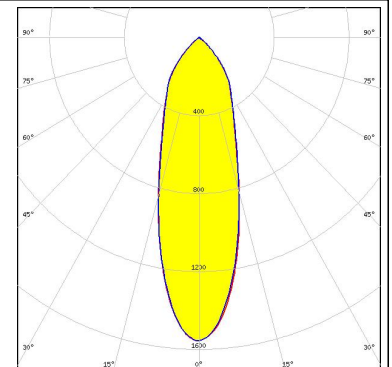
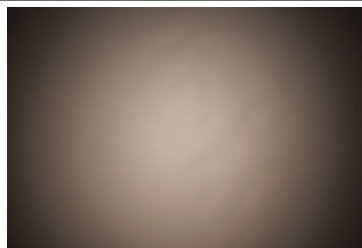

CITIZEN

LED LCN-C02B (Tunable White)
 FWHM 27.0°
 Efficiency 89 %
 Peak intensity 2.300 cd/lm
 LEDs/each optic 1
 Light colour White
 Required components:
 C16142_HEKLA-SOCKET-K

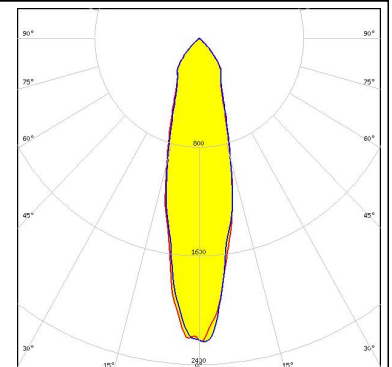
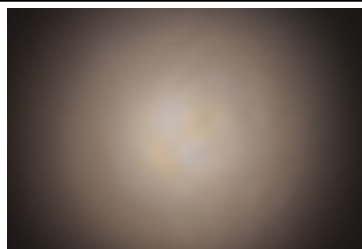

PHOTOMETRIC DATA (MEASURED):



LED CMA1516
 FWHM 18.0°
 Efficiency 94 %
 Peak intensity 4.200 cd/lm
 LEDs/each optic 1
 Light colour White
 Required components:
 F15256_HEKLA-SOCKET-D

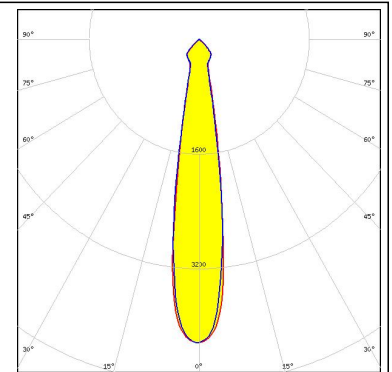

LED CMA1825
 FWHM 24.0°
 Efficiency 94 %
 Peak intensity 2.700 cd/lm
 LEDs/each optic 1
 Light colour White
 Required components:
 F15254_HEKLA-SOCKET-B

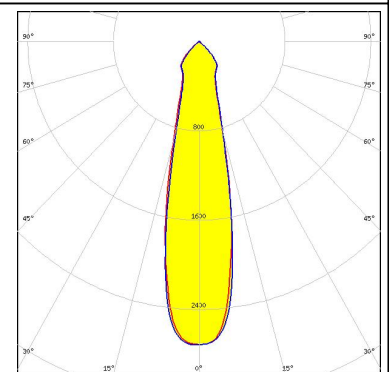
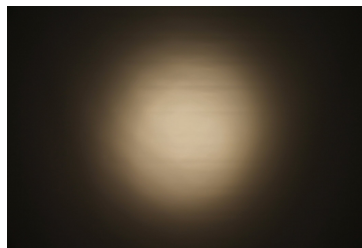

LED CMT14xx
 FWHM 19.0°
 Efficiency 95 %
 Peak intensity 3.800 cd/lm
 LEDs/each optic 1
 Light colour White
 Required components:
 F15255_HEKLA-SOCKET-C

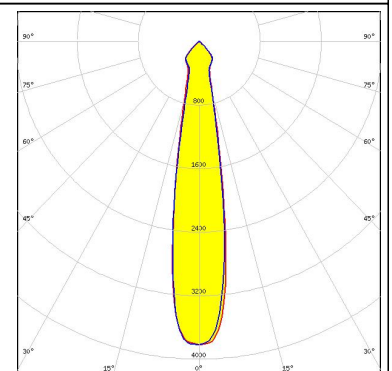
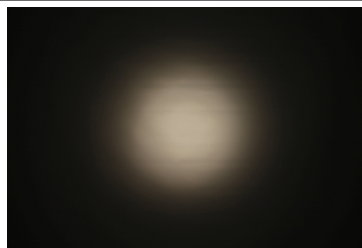

LED CXA/B 13xx
 FWHM 11.0°
 Efficiency 94 %
 Peak intensity 8.200 cd/lm
 LEDs/each optic 1
 Light colour White
 Required components:
 F15956_HEKLA-SOCKET-J

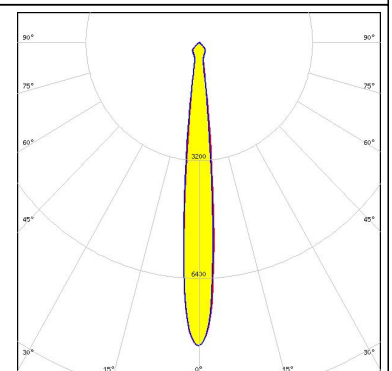

PHOTOMETRIC DATA (MEASURED):



LED CXA/B 15xx
 FWHM 16.0°
 Efficiency 94 %
 Peak intensity 4.400 cd/lm
 LEDs/each optic 1
 Light colour White
 Required components:
 F15256_HEKLA-SOCKET-D

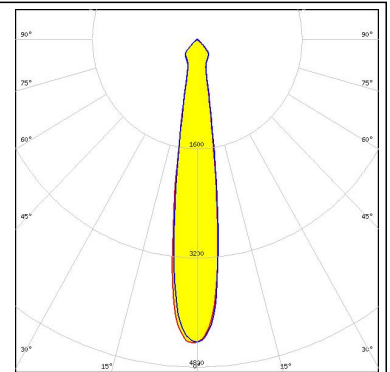

LED LUXEON CoB 1202HD
 FWHM 13.0°
 Efficiency 95 %
 Peak intensity 7.480 cd/lm
 LEDs/each optic 1
 Light colour White
 Required components:
 F15848_HEKLA-SOCKET-G

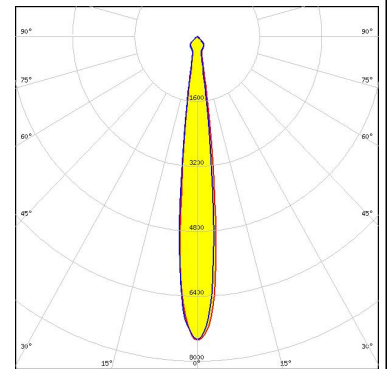
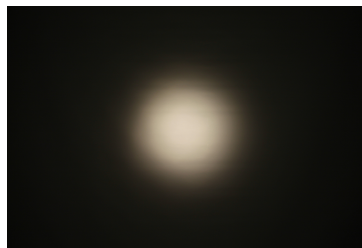

LED LUXEON CoB 1204HD
 FWHM 18.0°
 Efficiency 96 %
 Peak intensity 4.600 cd/lm
 LEDs/each optic 1
 Light colour White
 Required components:
 F15858_HEKLA-SOCKET-H

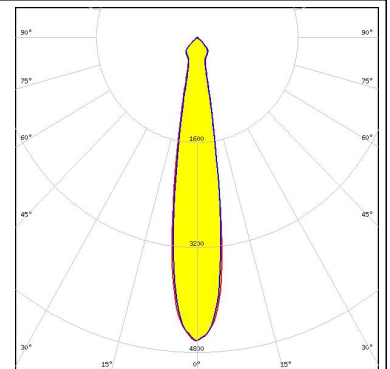
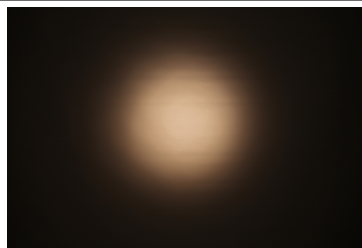

LED LUXEON CoB 1205HD
 FWHM 22.0°
 Efficiency 94 %
 Peak intensity 3.170 cd/lm
 LEDs/each optic 1
 Light colour White
 Required components:
 F15858_HEKLA-SOCKET-H

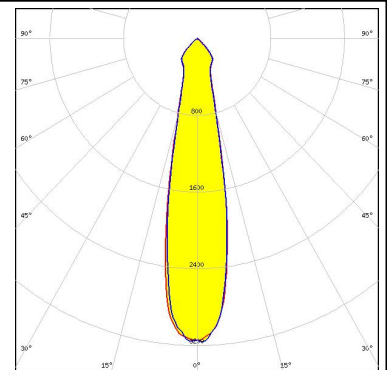
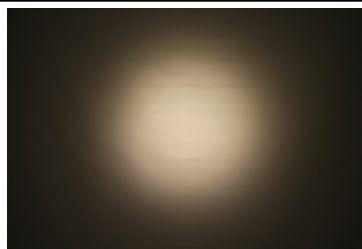

PHOTOMETRIC DATA (MEASURED):



LED CDM-14 (Dim-To-Warm)
 FWHM 28.0°
 Efficiency 83 %
 Peak intensity 1.800 cd/lm
 LEDs/each optic 1
 Light colour White
 Required components:
 C16142_HEKLA-SOCKET-K
 C14658_BARBARA-RZ-LENS
 Bender Wirth: 491 Typ L8

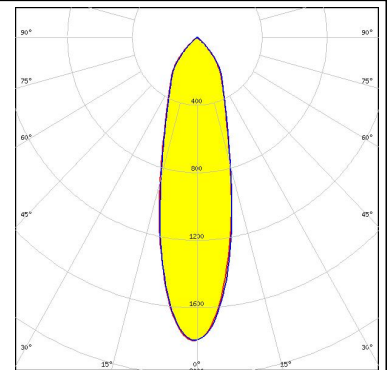

LED CDM-6 (Dim-To-Warm)
 FWHM 18.0°
 Efficiency 86 %
 Peak intensity 3.600 cd/lm
 LEDs/each optic 1
 Light colour White
 Required components:
 C16142_HEKLA-SOCKET-K
 C14658_BARBARA-RZ-LENS
 Bender Wirth: 490 Typ L8

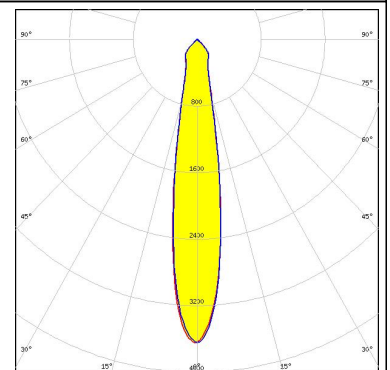
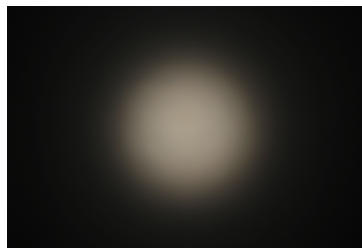



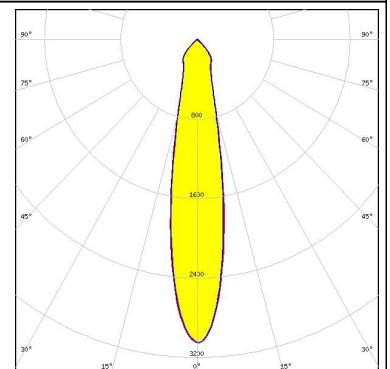
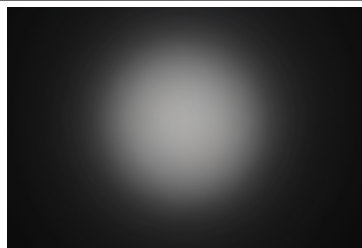

LED CDM-9 (Dim-To-Warm)
 FWHM 21.0°
 Efficiency 85 %
 Peak intensity 3.100 cd/lm
 LEDs/each optic 1
 Light colour White
 Required components:
 C16142_HEKLA-SOCKET-K
 C14658_BARBARA-RZ-LENS
 Bender Wirth: 490 Typ L8

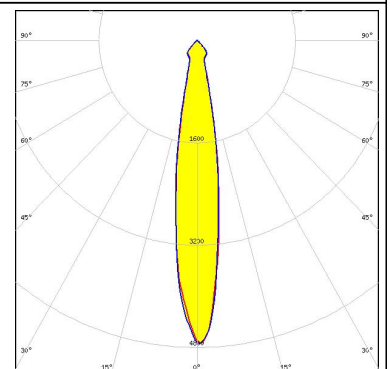
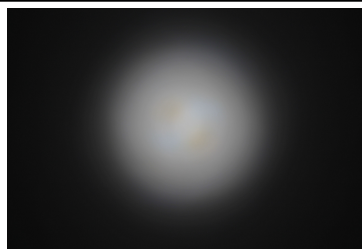



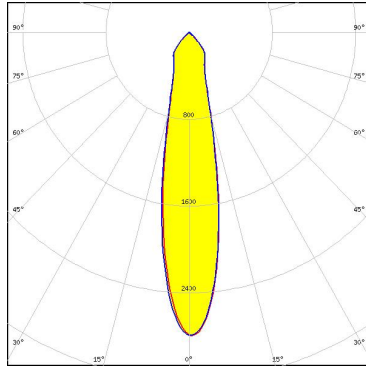
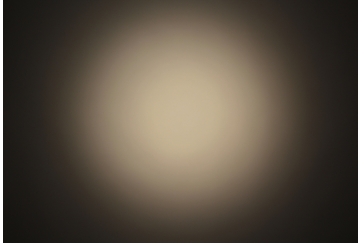
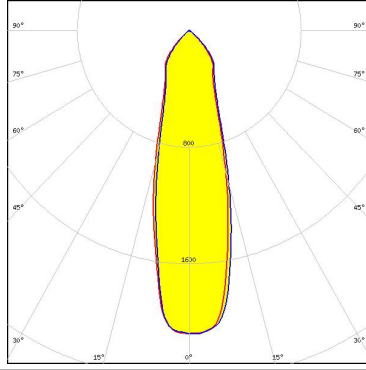

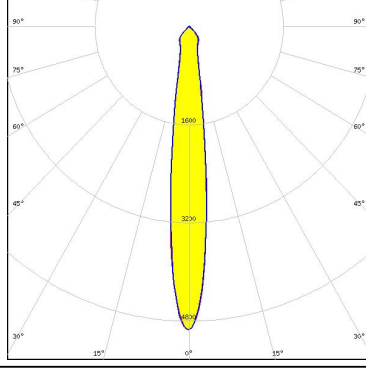
LED CDM-9 (Dim-To-Warm)
 FWHM 17.0°
 Efficiency 90 %
 Peak intensity 4.800 cd/lm
 LEDs/each optic 1
 Light colour White
 Required components:
 C16142_HEKLA-SOCKET-K
 Bender Wirth: 490 Typ L8

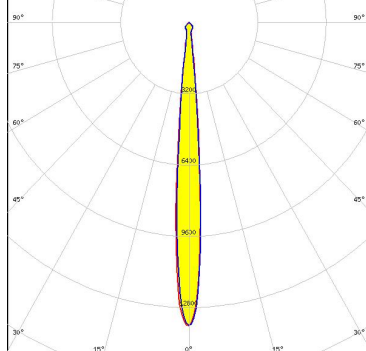

PHOTOMETRIC DATA (MEASURED):

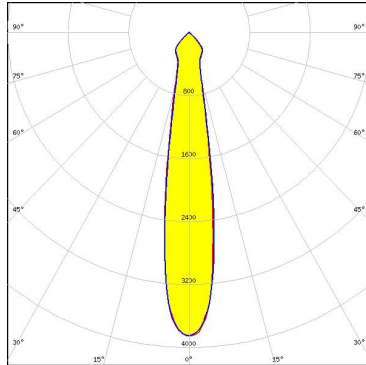
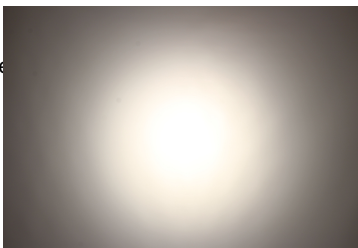
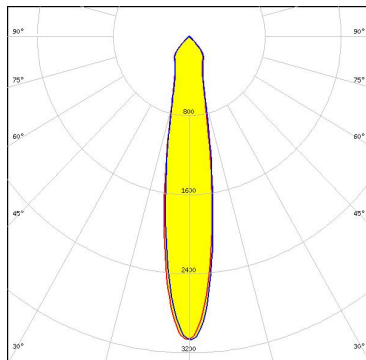
<p>LUMINUS</p> <p>LED CTM-9 (Tunable White) FWHM 22.0° Efficiency 85 % Peak intensity 2.800 cd/lm LEDs/each optic 1 Light colour White</p> <p>Required components: C16142_HEKLA-SOCKET-K C14658_BARBARA-RZ-LENS Bender Wirth: 495 Typ L8</p>		
<p>LUMINUS</p> <p>LED CxM-14 (19x19) FWHM 29.0° Efficiency 94 % Peak intensity 2.100 cd/lm LEDs/each optic 1 Light colour White</p> <p>Required components: F15859_HEKLA-SOCKET-I</p>		
<p>LUMINUS</p> <p>LED CXM-4 FWHM 14.0° Efficiency 89 % Peak intensity 4.944 cd/lm LEDs/each optic 1 Light colour White</p> <p>Required components: F15255_HEKLA-SOCKET-C C14658_BARBARA-RZ-LENS</p>		
<p>LUMINUS</p> <p>LED CXM-4 FWHM 9.0° Efficiency 94 % Peak intensity 13.619 cd/lm LEDs/each optic 1 Light colour White</p> <p>Required components: F15255_HEKLA-SOCKET-C</p>		

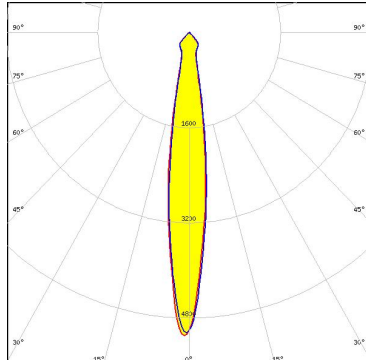
PHOTOMETRIC DATA (MEASURED):

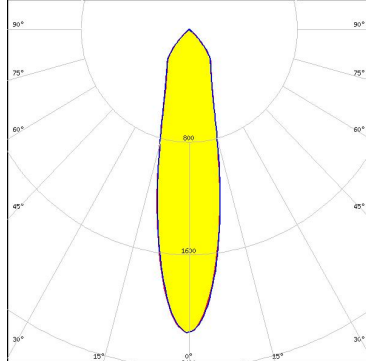
<p>LUMINUS</p> <p>LED CxM-9 (13.5x13.5) FWHM 18.0° Efficiency 94 % Peak intensity 3.900 cd/lm LEDs/each optic 1 Light colour White Required components: F15255_HEKLA-SOCKET-C</p>		
<p>NICHIA</p> <p>LED NJCWL024Z-V1MT: COB L-Type Tunable White FWHM 18.0° Efficiency 81 % Peak intensity 3.100 cd/lm LEDs/each optic 1 Light colour White Required components: C16142_HEKLA-SOCKET-K C14658_BARBARA-RZ-LENS Bender Wirth: 497 Typ L8</p>		
<p>NICHIA</p> <p>LED NJCWL024Z-V1MT: COB L-Type Tunable White FWHM 15.0° Efficiency 86 % Peak intensity 5.100 cd/lm LEDs/each optic 1 Light colour White Required components: C16142_HEKLA-SOCKET-K Bender Wirth: 497 Typ L8</p>		
<p>NICHIA</p> <p>LED NVCWJ024Z-V1MT: COB J-Type Tunable White FWHM 25.0° Efficiency 85 % Peak intensity 2.200 cd/lm LEDs/each optic 1 Light colour White Required components: C16142_HEKLA-SOCKET-K C14658_BARBARA-RZ-LENS Bender Wirth: 498 Typ L2</p>		

PHOTOMETRIC DATA (MEASURED):

PHILIPS

LED Fortimo SLM L09 CoB
 FWHM 21.0°
 Efficiency 89 %
 Peak intensity 2.800 cd/lm
 LEDs/each optic 1
 Light colour White
 Required components:
 F15858_HEKLA-SOCKET-H
 C14658_BARBARA-RZ-LENS

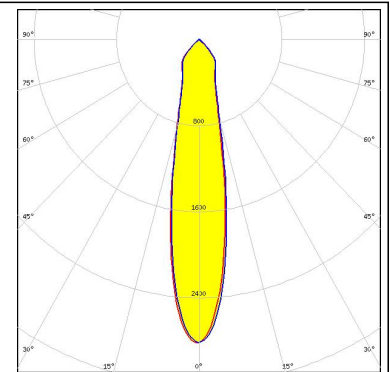
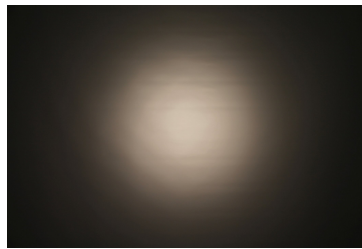

PHILIPS

LED Fortimo SLM L09 CoB
 FWHM 18.0°
 Efficiency 94 %
 Peak intensity 4.200 cd/lm
 LEDs/each optic 1
 Light colour White
 Required components:
 F15858_HEKLA-SOCKET-H

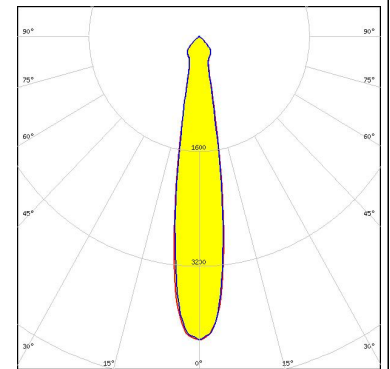
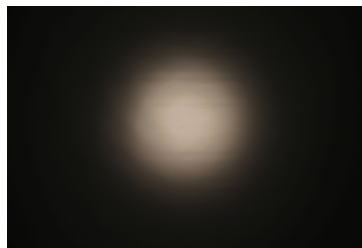

PHILIPS

LED Fortimo SLM L13 CoB
 FWHM 32.0°
 Efficiency 85 %
 Peak intensity 1.600 cd/lm
 LEDs/each optic 1
 Light colour White
 Required components:
 C16142_HEKLA-SOCKET-K
 C14658_BARBARA-RZ-LENS
 Bender Wirth: 432 Typ L8

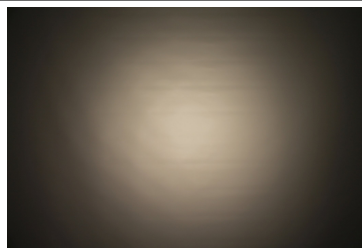

PHILIPS

LED Fortimo SLM L13 CoB
 FWHM 27.0°
 Efficiency 89 %
 Peak intensity 2.100 cd/lm
 LEDs/each optic 1
 Light colour White
 Required components:
 C16142_HEKLA-SOCKET-K
 Bender Wirth: 432 Typ L8

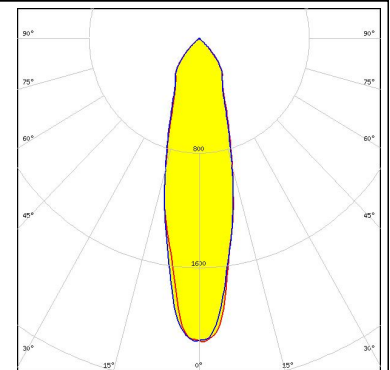
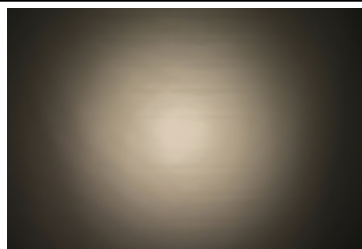

PHOTOMETRIC DATA (MEASURED):

SAMSUNG

LED COB D Series LES 9.8 mm
 FWHM 18.0°
 Efficiency 94 %
 Peak intensity 4.300 cd/lm
 LEDs/each optic 1
 Light colour White
 Required components:
 F15255_HEKLA-SOCKET-C

SAMSUNG

LED COB D Series LES 9.8 mm
 FWHM 22.0°
 Efficiency 90 %
 Peak intensity 2.800 cd/lm
 LEDs/each optic 1
 Light colour White
 Required components:
 F15255_HEKLA-SOCKET-C
 C14658_BARBARA-RZ-LENS

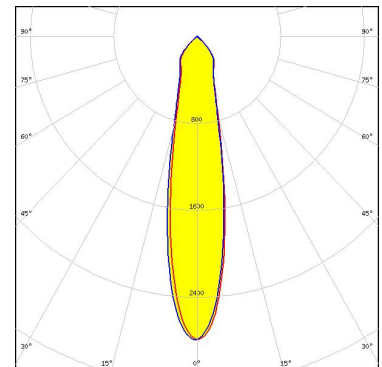

SAMSUNG

LED COB D Series LES 9.8 mm
 FWHM 18.0°
 Efficiency 94 %
 Peak intensity 4.300 cd/lm
 LEDs/each optic 1
 Light colour White
 Required components:
 F15255_HEKLA-SOCKET-C

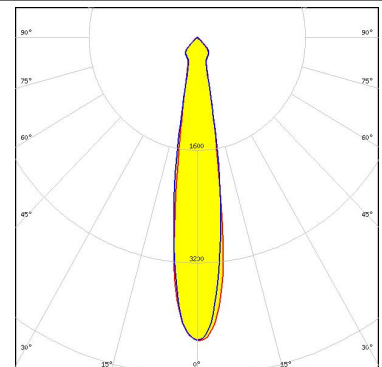

SAMSUNG

LED LC010C G2
 FWHM 11.0°
 Efficiency 93 %
 Peak intensity 9.000 cd/lm
 LEDs/each optic 1
 Light colour White
 Required components:
 F15255_HEKLA-SOCKET-C

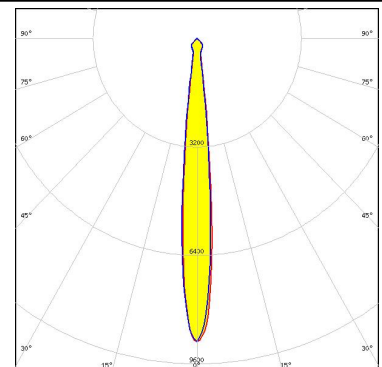

PHOTOMETRIC DATA (MEASURED):

SAMSUNG

LED LC010T (Tunable White)
 FWHM 23.0°
 Efficiency 86 %
 Peak intensity 2.514 cd/lm
 LEDs/each optic 1
 Light colour Tunable White
 Required components:
 C16142_HEKLA-SOCKET-K
 C14658_BARBARA-RZ-LENS
 Bender Wirth: 501 Typ L8

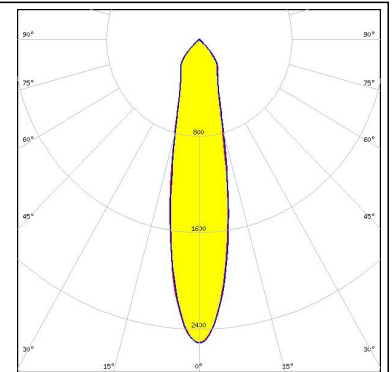
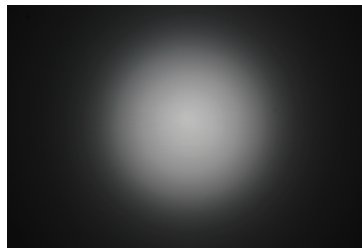

SAMSUNG

LED LC010T (Tunable White)
 FWHM 18.0°
 Efficiency 91 %
 Peak intensity 3.945 cd/lm
 LEDs/each optic 1
 Light colour Tunable White
 Required components:
 C16142_HEKLA-SOCKET-K
 Bender Wirth: 501 Typ L8

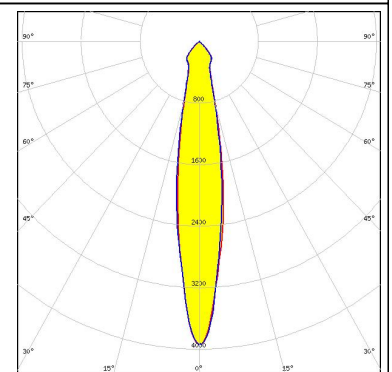

SAMSUNG

LED LC020C G2
 FWHM 17.0°
 Efficiency 94 %
 Peak intensity 4.600 cd/lm
 LEDs/each optic 1
 Light colour White
 Required components:
 F15859_HEKLA-SOCKET-I

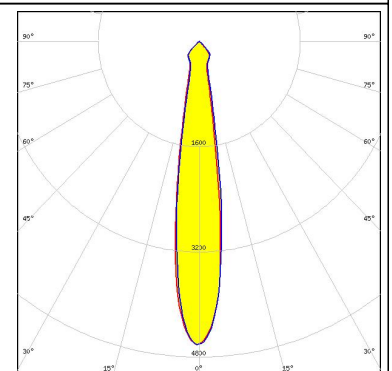
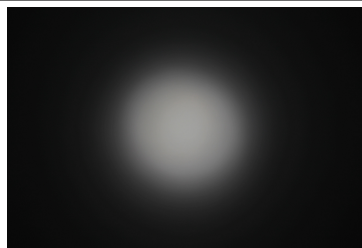

SAMSUNG

LED LC020T (Tunable white)
 FWHM 31.0°
 Efficiency 85 %
 Peak intensity 1.647 cd/lm
 LEDs/each optic 1
 Light colour Tunable White
 Required components:
 C16142_HEKLA-SOCKET-K
 C14658_BARBARA-RZ-LENS
 Bender Wirth: 501 Typ L8

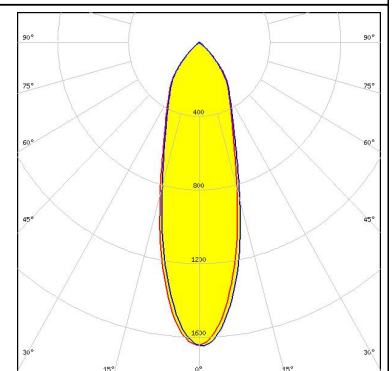
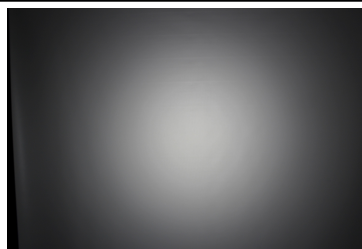

PHOTOMETRIC DATA (MEASURED):

SAMSUNG

LED LC020T (Tunable white)
 FWHM 26.0°
 Efficiency 90 %
 Peak intensity 2.363 cd/lm
 LEDs/each optic 1
 Light colour Tunable White
 Required components:
 C16142_HEKLA-SOCKET-K
 Bender Wirth: 501 Typ L8

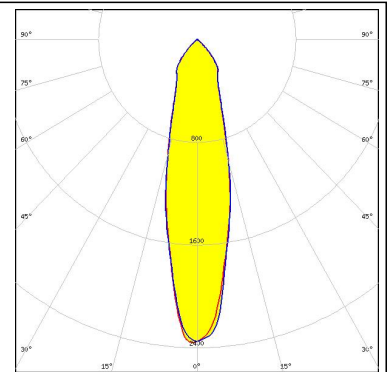

SEOUL SEMICONDUCTOR
 LED MJT COB LES 6
 FWHM 11.0°
 Efficiency 93 %
 Peak intensity 8.300 cd/lm
 LEDs/each optic 1
 Light colour White
 Required components:
 F15255_HEKLA-SOCKET-C

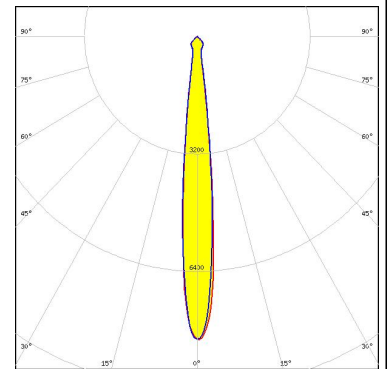

SEOUL SEMICONDUCTOR
 LED MJT COB LES 9.8
 FWHM 20.0°
 Efficiency 92 %
 Peak intensity 3.300 cd/lm
 LEDs/each optic 1
 Light colour White
 Required components:
 F15255_HEKLA-SOCKET-C

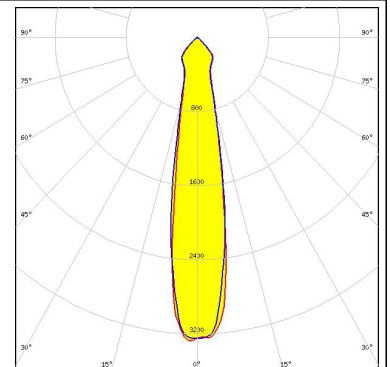

TRIDONIC

LED SLE G7 LES09
 FWHM 20.0°
 Efficiency 91 %
 Peak intensity 3.100 cd/lm
 LEDs/each optic 1
 Light colour White
 Required components:
 F15255_HEKLA-SOCKET-C
 C14658_BARBARA-RZ-LENS

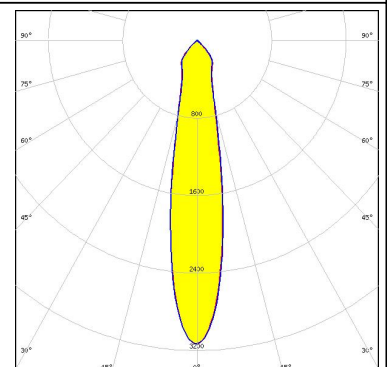

PHOTOMETRIC DATA (MEASURED):

TRIDONIC

LED SLE G7 LES09
 FWHM 17.0°
 Efficiency 94 %
 Peak intensity 4.800 cd/lm
 LEDs/each optic 1
 Light colour White
 Required components:
 F15255_HEKLA-SOCKET-C

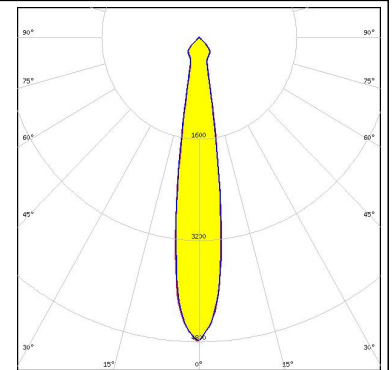

TRIDONIC

LED SLE G7 LES13
 FWHM 29.0°
 Efficiency 87 %
 Peak intensity 1.800 cd/lm
 LEDs/each optic 1
 Light colour White
 Required components:
 F15859_HEKLA-SOCKET-I
 C14658_BARBARA-RZ-LENS

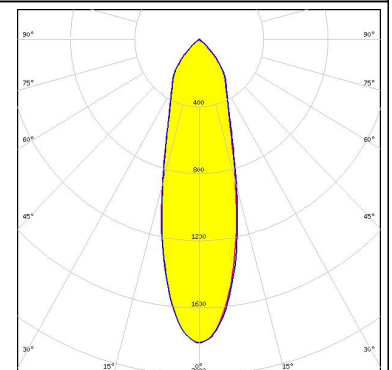
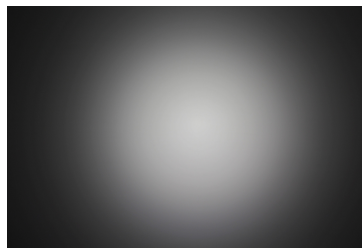

TRIDONIC

LED SLE G7 LES13
 FWHM 26.0°
 Efficiency 94 %
 Peak intensity 2.500 cd/lm
 LEDs/each optic 1
 Light colour White
 Required components:
 F15859_HEKLA-SOCKET-I

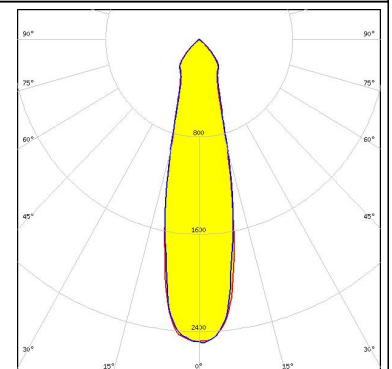
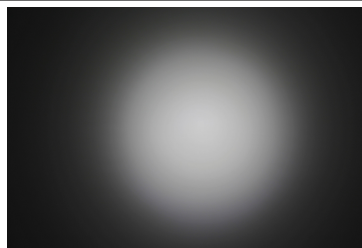

TRIDONIC

LED SLE G7 LES15
 FWHM 28.0°
 Efficiency 94 %
 Peak intensity 2.200 cd/lm
 LEDs/each optic 1
 Light colour White
 Required components:
 F15859_HEKLA-SOCKET-I

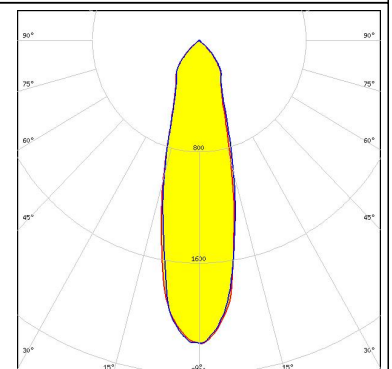
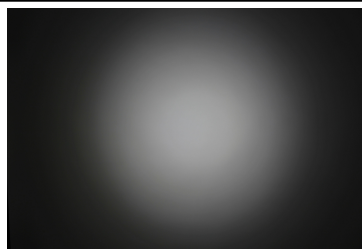

PHOTOMETRIC DATA (MEASURED):

XICATO

LED XOB 14.5 mm
 FWHM 27.0°
 Efficiency 94 %
 Peak intensity 2.194 cd/lm
 LEDs/each optic 1
 Light colour White
 Required components:
 F15859_HEKLA-SOCKET-I

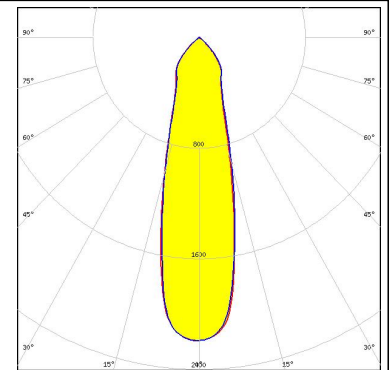

XICATO

LED XOB 6 mm
 FWHM 15.0°
 Efficiency 88 %
 Peak intensity 4.193 cd/lm
 LEDs/each optic 1
 Light colour White
 Required components:
 F15255_HEKLA-SOCKET-C
 C14658_BARBARA-RZ-LENS

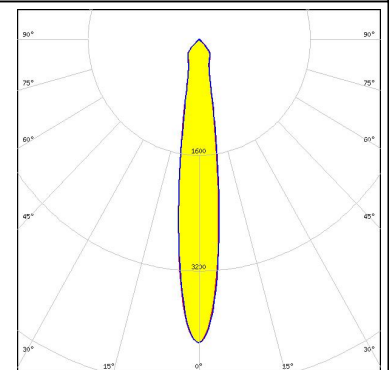
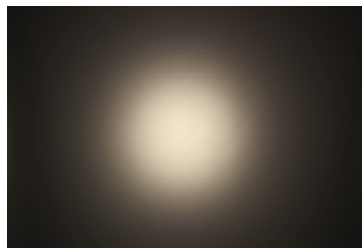

XICATO

LED XOB 6 mm
 FWHM 11.0°
 Efficiency 94 %
 Peak intensity 8.691 cd/lm
 LEDs/each optic 1
 Light colour White
 Required components:
 F15255_HEKLA-SOCKET-C

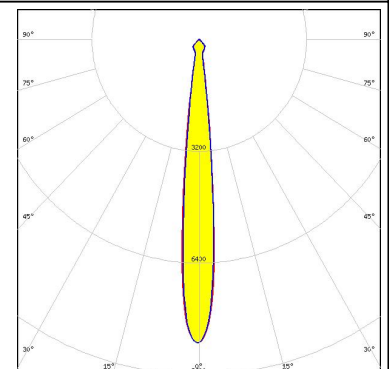
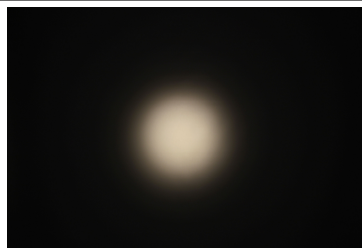

XICATO

LED XOB 9.8 mm
 FWHM 21.0°
 Efficiency 90 %
 Peak intensity 2.908 cd/lm
 LEDs/each optic 1
 Light colour White
 Required components:
 F15255_HEKLA-SOCKET-C
 C14658_BARBARA-RZ-LENS

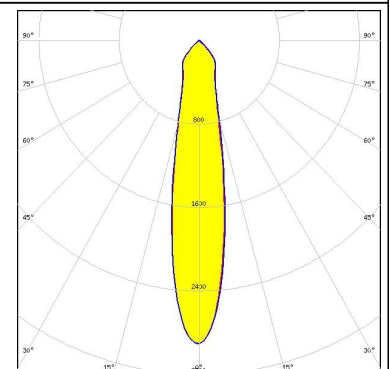

PHOTOMETRIC DATA (MEASURED):

XICATO

LED XOB 9.8 mm
FWHM 16.0°
Efficiency 94 %
Peak intensity 4.643 cd/lm
LEDs/each optic 1
Light colour White
Required components:
F15255_HEKLA-SOCKET-C

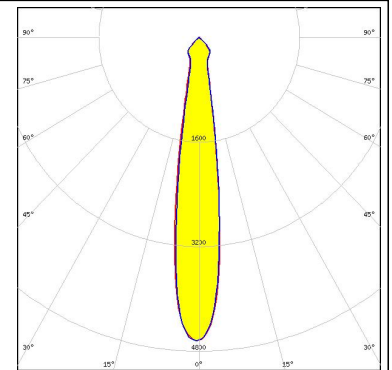

XICATO

LED XTM - 19mm LES
FWHM 33.0°
Efficiency 92 %
Peak intensity 1.700 cd/lm
LEDs/each optic 1
Light colour White
Required components:
C15743_XTM-ADAPTER-50-B

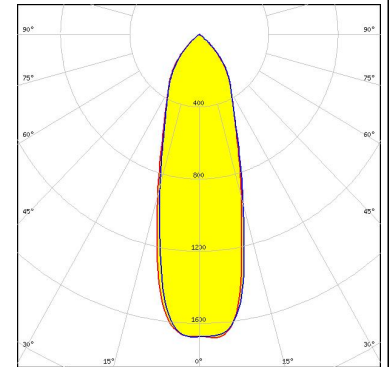
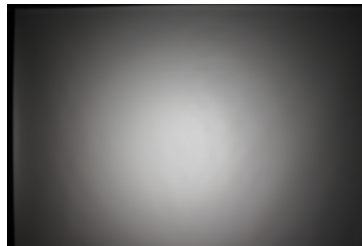

XICATO

LED XTM - 9mm LES
FWHM 17.0°
Efficiency 94 %
Peak intensity 4.800 cd/lm
LEDs/each optic 1
Light colour White
Required components:
C15743_XTM-ADAPTER-50-B

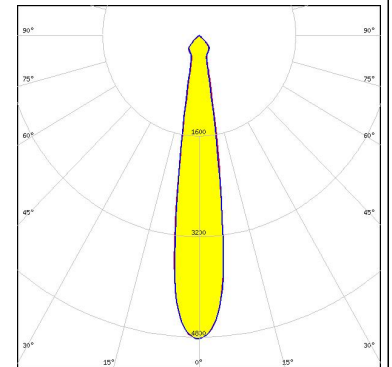
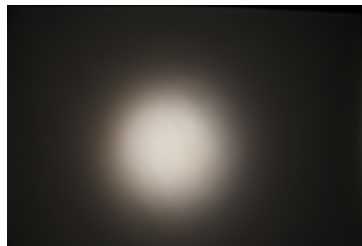

PHOTOMETRIC DATA (SIMULATED):

bridgelux.

LED V10 Gen6
FWHM 15.0°
Efficiency %
Peak intensity cd/lm
LEDs/each optic 1
Light colour White
Required components:
F14988_HEKLA-SOCKET-E

bridgelux.

LED V10 Gen6
FWHM 15.0°
Efficiency 0 %
Peak intensity 0.000 cd/lm
LEDs/each optic 1
Light colour White
Required components:
F14988_HEKLA-SOCKET-E

bridgelux.

LED V13 Gen6
FWHM 24.0°
Efficiency 92 %
Peak intensity 2.844 cd/lm
LEDs/each optic 1
Light colour White
Required components:
F14988_HEKLA-SOCKET-E

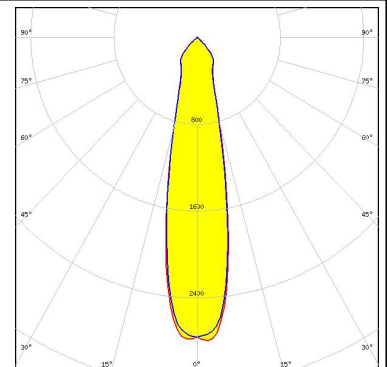

bridgelux.

LED V8 Gen6
FWHM 15.0°
Efficiency 0 %
Peak intensity 0.000 cd/lm
LEDs/each optic 1
Light colour White
Required components:
F15253_HEKLA-SOCKET-A

PHOTOMETRIC DATA (SIMULATED):

bridgelux

LED V8 Gen6
 FWHM 15.0°
 Efficiency 0 %
 Peak intensity 0.000 cd/lm
 LEDs/each optic 1
 Light colour White
 Required components:
 F15253_HEKLA-SOCKET-A

bridgelux

LED Vesta TW 9mm (9W) DP
 FWHM 18.0°
 Efficiency 87 %
 Peak intensity 3.538 cd/lm
 LEDs/each optic 1
 Light colour White
 Required components:
 C16142_HEKLA-SOCKET-K
 C14658_BARBARA-RZ-LENS
 Bender Wirth: 489 Typ L8

CITIZEN

LED CLL02x/CLU02x (LES10)
 FWHM 18.0°
 Efficiency 92 %
 Peak intensity 4.300 cd/lm
 LEDs/each optic 1
 Light colour White
 Required components:
 F15255_HEKLA-SOCKET-C

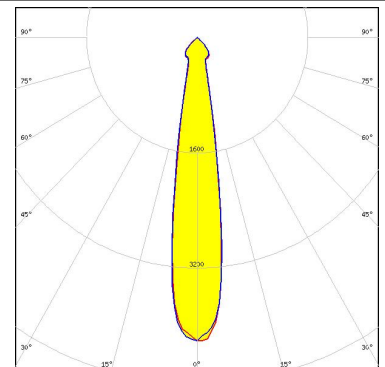

CITIZEN

LED CLL03x/CLU03x
 FWHM 31.0°
 Efficiency 93 %
 Peak intensity 1.890 cd/lm
 LEDs/each optic 1
 Light colour White
 Required components:
 F15859_HEKLA-SOCKET-I

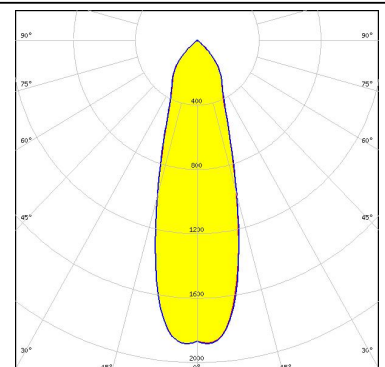

PHOTOMETRIC DATA (SIMULATED):



LED CMT14xx
FWHM 17.0°
Efficiency 90 %
Peak intensity 4.240 cd/lm
LEDs/each optic 1
Light colour White
Required components:
F15255_HEKLA-SOCKET-C

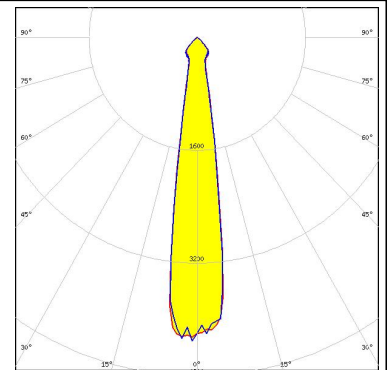

LED CXA/B 15xx
FWHM 15.0°
Efficiency 0 %
Peak intensity 0.000 cd/lm
LEDs/each optic 1
Light colour White
Required components:
F15256_HEKLA-SOCKET-D



LED CXA/B 1816 & CXA/B 1820 & CXA 1850
FWHM 22.0°
Efficiency 0 %
Peak intensity 0.000 cd/lm
LEDs/each optic 1
Light colour White
Required components:
F15254_HEKLA-SOCKET-B



LED CXA/B 1816 & CXA/B 1820 & CXA 1850
FWHM 22.0°
Efficiency %
Peak intensity cd/lm
LEDs/each optic 1
Light colour White
Required components:
F15254_HEKLA-SOCKET-B

PHOTOMETRIC DATA (SIMULATED):

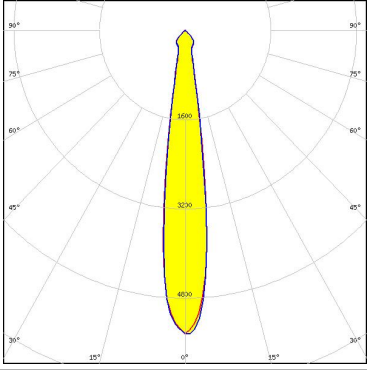
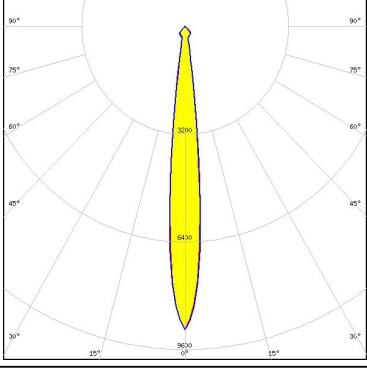
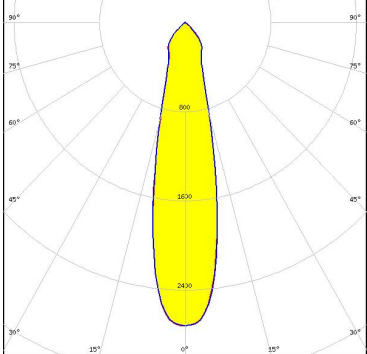
<p>NICHIA</p> <p>LED COB L-Type (LES 11)</p> <p>FWHM 20.0°</p> <p>Efficiency 93 %</p> <p>Peak intensity 3.339 cd/lm</p> <p>LEDs/each optic 1</p> <p>Light colour White</p> <p>Required components: F15858_HEKLA-SOCKET-H</p>	
<p>NICHIA</p> <p>LED COB L-Type (LES 9)</p> <p>FWHM 16.0°</p> <p>Efficiency 93 %</p> <p>Peak intensity 5.400 cd/lm</p> <p>LEDs/each optic 1</p> <p>Light colour White</p> <p>Required components: F15858_HEKLA-SOCKET-H</p>	
<p>NICHIA</p> <p>LED COB T-Type</p> <p>FWHM 12.0°</p> <p>Efficiency 91 %</p> <p>Peak intensity 9.020 cd/lm</p> <p>LEDs/each optic 1</p> <p>Light colour White</p> <p>Required components: F15848_HEKLA-SOCKET-G</p>	
<p>OSRAM Opto Semiconductors</p> <p>LED Soleriq S13 19x19</p> <p>FWHM 23.9°</p> <p>Efficiency 93 %</p> <p>Peak intensity 2.730 cd/lm</p> <p>LEDs/each optic 1</p> <p>Light colour White</p> <p>Required components: F15859_HEKLA-SOCKET-I</p>	

PHOTOMETRIC DATA (SIMULATED):

OSRAM

Opto Semiconductors

LED Soleriq S9
FWHM 17.4°
Efficiency 93 %
Peak intensity 4.360 cd/lm
LEDs/each optic 1
Light colour White
Required components:
F15255_HEKLA-SOCKET-C

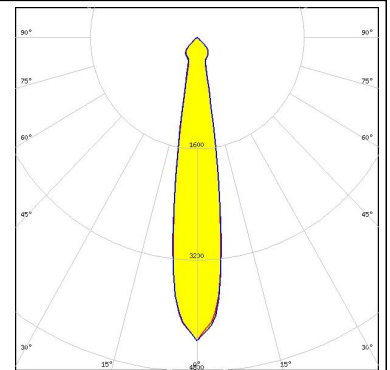

SAMSUNG

LED COB D Series LES 14.5 mm
FWHM 29.0°
Efficiency 88 %
Peak intensity 1.940 cd/lm
LEDs/each optic 1
Light colour White
Required components:
F15859_HEKLA-SOCKET-I

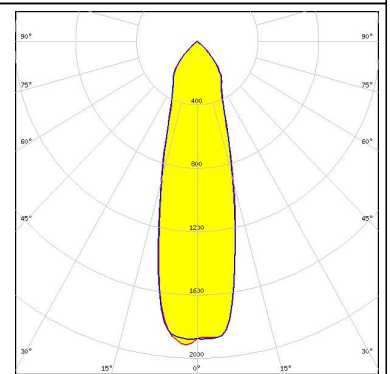

GENERAL INFORMATION:

NOTE: The typical beam angle will be changed by different color, chip size and chip position tolerance. The typical total beam angle is the full angle measured where the luminous intensity is half of the peak value.

Due to use of high power COB's with this product, special attention to proper thermal design is highly recommended. LEDiL has no liability for direct, indirect or consecutive damages arising from the LEDiL products being used outside of the recommended temperature range.

MATERIALS:

As part of our continuous research and improvement processes, and to ensure the best possible quality and availability of our products, LEDiL reserves the right to change material grades without notice.

PRODUCT DATA USER AGREEMENT AND DISCLAIMER:

The measured data in the provided downloadable LEDiL Product Datasheets and Mechanical 2D-Drawings is rounded and provided as reference for planning. LEDiL Oy's optical specifications have been verified by conducting performance testing of the products in accordance with the company's quality system. The reported data are averaged results of multiple measurements with typical variation. LEDiL Oy reserves the right to without prior notification make changes and improvements to its products.

LEDiL Oy assumes neither warranty, nor guarantee nor any other liability of any kind for the contents and correctness of the provided data. The provided data has been generated with highest diligence but the provided data may in reality not represent the complete possible variation range of all intrinsic parameters. Therefore, in certain cases a deviation from the provided data could occur.

LEDiL Oy reserves the right to undertake technical changes of its products without further notification which could lead to changes in the provided data. LEDiL Oy assumes no liability of any kind for the possible deviation from any provided data or any other damage resulting from the usage of the provided data.

The user agrees to this disclaimer and user agreement with the download or usage of the provided files.

LEDiL Oy

Joensuunkatu 13
FI-24240 SALO
Finland

LEDiL Inc.

228 West Page Street
Suite D
Sycamore IL 60178
USA

Local sales and technical support

www.ledil.com/where_to_buy

Shipping locations

Salo, Finland
Hong Kong, China

Distribution Partners

www.ledil.com/where_to_buy