

KT

Inserts, small

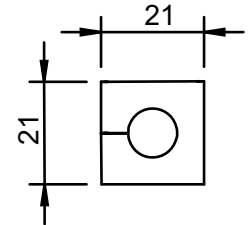

1

Product description

KT cable inserts small are used with the following cable entry frames:

- KEL - Page 6 - 13
- KEL-FG - Page 14-15
- KVT - Page 18 - 20
- KVT-W90 - Page 21

The model range KT small is designed for cable diameters from 2 to 17mm.

Assembly



When installing the insert, the smooth side of the insert faces the middle of the cable entry frame.

Specification KT grey

Material	Elastomer
Flame class	UL-94 Vo, self-extinguishing
Temperature	- 40°C to + 90°C (static)
Properties	halogen-free, silicone-free

Specification KT black

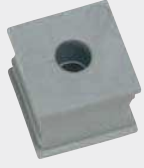
Material	Elastomer
Flame class	UL-94 HB
Temperature	- 30°C to + 90°C (static)
Properties	higher chemical resistance, UV-stabilized

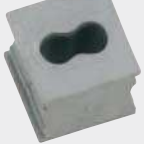
Description	Type	Order No grey	Order No black	Clamping range	PU
BTK 	BTK	41251	41351	Blind insert	10
KT 	KT 2	39934	41302	2 - 3 mm	10
	KT 3	41203	41303	3 - 4 mm	10
	KT 4	41204	41304	4 - 5 mm	10
	KT 5	41205	41305	5 - 6 mm	10
	KT 6	41206	41306	6 - 7 mm	10
	KT 7	41207	41307	7 - 8 mm	10
	KT 8	41208	41308	8 - 9 mm	10
	KT 9	41209	41309	9 - 10 mm	10
	KT 10	41210	41310	10 - 11 mm	10
	KT 11	41211	41311	11 - 12 mm	10
	KT 12	41212	41312	12 - 13 mm	10
	KT 13	41213	41313	13 - 14 mm	10
	KT 14	41214	41314	14 - 15 mm	10
	KT 15	41215	41315	15 - 16 mm	10
	KT tele 	KTs 16	39901	39912	16 mm
KTs 17		39900	39913	17 mm	10
KT tele	KT tele	39929	-	Telephone cable	10
KT oval 	KT oval	39930	-		10
	KT S1 	KT S1	39931	-	

KT Inserts, small

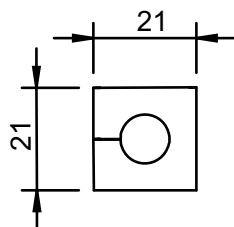

Type	Order No grey	Order No black	Clamping range	PU	Description
KT 2 2	39935	39936	2x \varnothing 2 mm	10	 KT 2 x
KT 2 3	39939	39940	2x \varnothing 3 mm	10	
KT 2 4	39906	39907	2x \varnothing 4 mm	10	
KT 2 5	41200	39904	2x \varnothing 5 mm	10	
KT 2 6	41201	39905	2x \varnothing 6 mm	10	
KT 2 7	41202	39916	2x \varnothing 7 mm	10	
KT 2 8	39917	39918	2x \varnothing 8 mm	10	
KT 4 2	39937	39938	4x \varnothing 2 mm	10	 KT 4 x
KT 4 3	39914	39915	4x \varnothing 3 mm	10	
KT 4 4	39909	39911	4x \varnothing 4 mm	10	
KT 4 5	39908	39910	4x \varnothing 5 mm	10	
KT 4 6	39932	39933	4x \varnothing 6 mm	10	
KT-ASI	39902	39903	1 ASI-cable	10	
KT-ASI2 rl	39922	39924	2 ASI-cables	10	
KT-ASI2 ll	39921	39923	2 ASI-cables	10	
					 KT ASI2 ll
KTRS 12	39990	-		10	
KTRS 13	39992	-		10	
KTRS 16	39996	-		10	

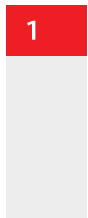

Product description

KT cable inserts small are used with the following cable entry frames:

- KEL - Page 6 - 13
- KEL-FG - Page 14 - 15
- KVT - Page 18 - 20
- KVT-Wgo - Page 21

The model range KT small is designed for cable diameters from 2 to 17mm.

Assembly

When installing the insert, the smooth side of the insert faces the middle of the cable entry frame.

Specification KT grey

Material	Elastomer
Flame class	UL-94 Vo, self-extinguishing
Temperature	- 40°C to + 90°C (static)
Properties	halogen-free, silicone-free

Specification KT black

Material	Elastomer
Flame class	UL-94 HB
Temperature	- 30°C to + 90°C (static)
Properties	higher chemical resistance, UV-stabilized

KT

Inserts, large

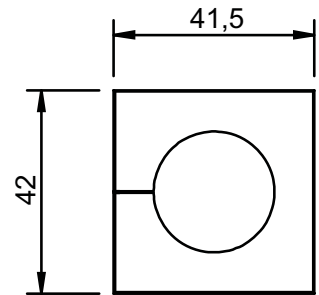

1

Product description

The KT inserts large accept a wide range of cable diameters from 16 to 34 mm. They are used with the following cable entry frames:

- KEL - Page 6 - 13
- KEL-FG - Page 14 - 15
- KVT / KVT-W90 - Page 18 - 21
- KEL 183 - Page 32



ATG adapter inserts provide the possibility to hold a small KT insert to reduce the clamping range down to 2 mm.

Specification KT grey

Material	Elastomer
Flame class	UL-94 Vo, self-extinguishing
Temperature	- 40°C to + 90°C (static)
Properties	halogen-free, silicone-free

Specification KT black

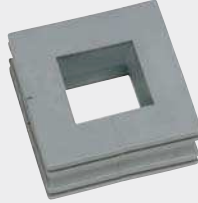
Material	Elastomer
Flame class	UL-94 HB
Temperature	- 30°C to + 90°C (static)
Properties	higher chemical resistance, UV-stabilized

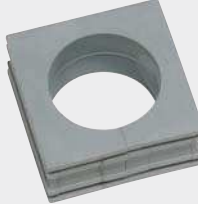
Description	Type	Order No. grey	Order No. black	Clamping range	PU
ATG 	ATG	41253	41353	Adapter insert	10
BTG 	BTG	41252	41352	Blind insert or 5 - 20 mm	10
KT 28 	KT 16	41216	41316	16 - 17 mm	10
	KT 17	41217	41317	17 - 18 mm	10
	KT 18	41218	41318	18 - 19 mm	10
	KT 19	41219	41319	19 - 20 mm	10
	KT 20	41220	41320	20 - 21 mm	10
	KT 21	41221	41321	21 - 22 mm	10
	KT 22	41222	41322	22 - 23 mm	10
	KT 23	41223	41323	23 - 24 mm	10
	KT 24	41224	41324	24 - 25 mm	10
	KT 25	41225	41325	25 - 26 mm	10
	KT 26	41226	41326	26 - 27 mm	10
	KT 27	41227	41327	27 - 28 mm	10
	KT 28	41228	41328	28 - 29 mm	10
	KT 29	41229	41329	29 - 30 mm	10
	KT 30	41230	41330	30 - 32 mm	10
	KT 32	41232	41332	32 - 33 mm	10
	KT 34	41234	41334	33 - 34 mm	10

KTMB

Inserts, multi-range

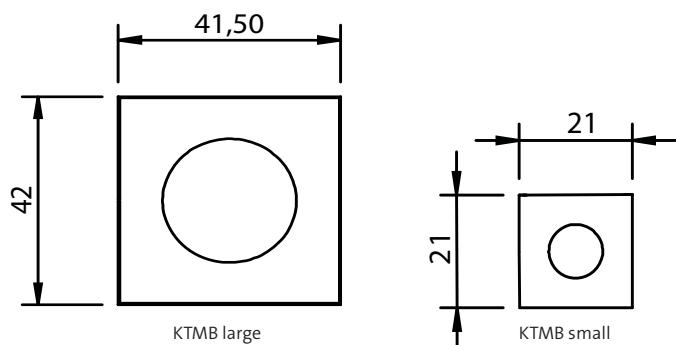

Type	Order No. grey	Size KT	Clamping range	PU	Description
------	-------------------	------------	----------------	----	-------------

KTMB-A	41432	KT small	2.5 - 6.5 mm	10	 KTMB-D
KTMB-B	41434	KT small	4.0 - 7.5 mm	10	
KTMB-C	41436	KT small	6.5 - 10 mm	10	
KTMB-D	41438	KT small	9.5 - 13 mm	10	
KTMB-E	41440	KT small	13 - 16 mm	10	
					 Cross section KTMB
KTMB-G	41460	KT large	13 - 18 mm	10	
KTMB-H	41465	KT large	18 - 23 mm	10	
KTMB-I	41470	KT large	23 - 28 mm	10	
KTMB-J	41475	KT large	28 - 33 mm	10	
KTMB-K	41480	KT large	2x 13 - 18 mm	10	

1

Product description KTMB

The KTMB inserts accept a wide range of cable diameters. A great benefit when exact cable diameter is not known in advance.

The KTMB inserts are not split and therefore only usable for cables without connectors.

Specification KTMB grey

Material	Elastomer
Flame class	UL-94 Vo, self-extinguishing
Temperature	- 40°C to+ 90°C (static)
Properties	halogen-free, silicone-free

Product description

The correct size of the KT inserts can easily be determined by using the cable template.

- Determining the diameter of the cable using the cable template
- Selecting the KT inserts according the data on the cable template

Order-No. 39800



DT

Cable entry inserts



1

Product description

The DT cable inserts are designed for standard cables (without connectors). A large number of cables can be routed utilizing minimal space.

DT inserts are designed to fit in KT large insert spaces:

- KEL 24 | KEL 16 | KEL 10 | KEL-B - Page 6 - 9
- KEL 24 Extensions - Page 11 - 13
- KEL-FG - Page 14 - 15
- KEL 183 - Page 32

Advantages

- Combination of routing pre-terminated and standard cables with one cable entry frame
- Enables a sub-assembly of cable harnesses
- High packing density

Specification

Material	Elastomer
Flame class	UL-94 Vo, self-extinguishing
Protection class	IP 54
Temperature	- 40°C to + 90°C (static)
Properties	halogen-free, silicone-free

Description	Type	Order No.	Number of cables	PU
	DT 1	41500	12x max. 6.5 mm 2x max. 12.2 mm	10
	DT 2	41510	16x max. 7.1 mm	10
	DT 3	41520	4x max. 6.5 mm 3x max. 9.5 mm 3x max. 11.3 mm	10
	DT 4	41530	9x max. 9.5 mm	10

ST Plugs



1

Type	Order No.	Diameter D	Length L	PU	Description
------	-----------	---------------	-------------	----	-------------

ST 2	42909	2,0 mm	25 mm	25	
ST 3	42901	3,0 mm	25 mm	25	
ST 4	42908	4,0 mm	25 mm	25	
ST 5	42906	5,0 mm	25 mm	25	
ST 6	42903	6,0 mm	25 mm	25	
ST 7	42905	7,0 mm	25 mm	25	
ST 8	42899	8,0 mm	20 mm	25	
ST 9	42897	9,0 mm	20 mm	25	
ST 10	42895	10,0 mm	20 mm	25	
ST 11	42893	11,0 mm	20 mm	25	
ST 12	42891	12,0 mm	20 mm	25	
ST 13	42889	13,0 mm	20 mm	25	
ST 14	42887	14,0 mm	20 mm	25	
ST 15	42885	15,0 mm	20 mm	25	
ST 16	42883	16,0 mm	20 mm	25	
ST 17	42881	17,0 mm	20 mm	25	

Product description

Plugs are used to close either KT inserts or KEL-DPZ cable entry plates not equipped with cables.

Perfect for applications where cables have been removed.

Advantages

- Sealing unused cable entries

Specification

Material	Polyamide, white
Flame class	UL-94 Vo, self-extinguishing
Protection class	IP 54
Temperature	- 40°C to + 120°C
Properties	halogen-free, silicone-free

Accessories

KT + DT Cable inserts	Page 22+23 26
Cable entry plates DPZ	Page 44 49
Cable entry plates DP	Page 50 52

KT Service box

Service box for cable inserts



KT | Service box for cable inserts

1

Product description

Convenient - everything readily available!

The service box is perfect for installations and service calls.

The KT service box ensures your KT inserts are readily available.

Order No. 88001

Content

Cable inserts, small:

- 116 KT for cables 2 - 17 mm
- 5 BTK blind inserts
- 10 KTMB multi-range inserts
- 8 KT-ASI for ASI-Bus cables

Cable inserts, large:

- 25 KT for cables 16 - 34 mm
- 4 BTG blind inserts / ATG adapter inserts
- 5 KTMB multi-range inserts

Accessories:

- 2 KEL-frames
- 1 KVT split cable gland
- 1 KZL strain relief plate
- 1 Cable template



The correct size of the KT inserts can easily be determined by using the cable template.

- Determining the diameter of the cable using the cable template
- Selecting the KT inserts according the data on the cable template

Cable templates can also be ordered separately (Order-No. 39800).